

**XL**

## **Sales manual 2025**







# XL

## Sales manual 2025



**Validity:**

This model list is effective from 01.01.2025. All previously published lists hereby cease to be valid.

**Note:**

All rights reserved for minor discrepancies in the dimensions and finishes, front and worktop colours, modifications due to technology in

progress and printing errors. Differences in colour reproduction in illustrations in relation to the original colour are due to printing technology.

Active member



**KM** KÜCHENMEILE  
GERMANY







# table of contents

Corner tall shelf units 156 cm high	XL 6.2.7 End-of-range:	XL.17-20/XL. 1.3-5/XL.1.10/XL.2.13-16
Corner wall units 65 cm high	XL 5.2.17-18 Extra charge	XL 3.0.2/XL 6.0.2/ZU. GL84/ZU. XL83
Corner wall units 78 cm high	XL 5.3.7-8 Extra charge for special lacquering	XL.1.9/XL.1.11/XL.2.22-25/XL.2.27-28
Corner wall units 91 cm high	XL 5.4.6-7 Extra charge for split GSP fronts	ZU. GL84/ZU. XL83
Cornice	XL 10.0.1-2 Extractor hood wall units 52 cm high	XL 5.2.4-5
Crockery cupboards 130 cm high	XL 7.1.12 Extractor hood wall units 65 cm high	XL 5.2.13-14
Crockery cupboards 143 cm high	XL 6.1.3-4 Extractor hood wall units 78 cm high	XL 5.3.3
Crockery cupboards 143 cm high with glass front	XL 6.1.6 Extractor hood wall units 91 cm high	XL 5.4.3-4
Crockery cupboards 143 cm high, angled	XL 6.1.2 F	
Crockery cupboards 156 cm high	XL 6.2.4-5 Felt mat for TAKEAWAY stacking box	XL 3.3.36
Crockery cupboards 156 cm high with glass front	XL 6.2.7 FIXOL Universal set	ZU.XL/GL26
Crockery cupboards 156 cm high, angled	XL 6.2.3 Flap door module	XL 8.0.12-13/XL 8.1.5
Crockery cupboards 168.8 cm high	XL 6.3.3-4 Flex-Design	XL 3.0.4/XL 6.0.5/ZU. GL84
Crockery cupboards 168.8 cm high with glass front	XL 6.3.6 Floor sealing band for panels	XL 9.0.3/XL 9.0.5/XL 9.0.7
Crockery cupboards 168.8 cm high, angled	XL 6.3.3 Flour, sugar and rice scoops in carcass decors	XL 5.2.8/XL 5.2.19/XL 5.3.10/XL 5.4.9
Crockery cupboards 181.8 cm high	XL 6.4.3-4 Flush fitted sliding door system	XL 3.9.2-3
Crockery cupboards 181.8 cm high with glass front	XL 6.4.6 Frame element for hanging recycling bags	ZU.XL/GL31
Crockery cupboards 181.8 cm high, angled	XL 6.4.3/XL 6.5.3 FREE ELEMENTS	XL 7.5.17-22
Crockery cupboards 194.8 cm high	XL 6.5.4-5/XL 6.5.7 FREEBOARD	XL 7.5.12-13
Crockery cupboards 194.8 cm high with glass front	XL 6.5.8 FREEBRIDGE	XL 7.5.7-8
Crockery cupboards 194.8 cm high, angled	XL 6.5.3 FREEBRIDGE accessories	XL 7.5.8
Crockery cupboards 207.8 cm high	XL 6.6.5-7/XL 6.6.23/XL 7.2.3 FREEMOBILE	XL 7.5.8-12/XL 7.6.10/ZU.XL/GL31
Crockery cupboards 207.8 cm high with glass front	XL 6.6.9 FREESTYLE plinth frame for modular configurations	XL 7.5.1/ZU. GL74
Crockery cupboards 207.8 cm high, angled	XL 6.6.4 FREEWALL shelf system	XL 7.5.1/XL 7.5.3-6/ZU. GL74
Crockery cupboards 220.8 cm high	XL 6.7.6-8/XL 6.7.23/XL 7.6.6 Front decor panels	XL 3.1.12/XL 3.2.18/XL 3.3.25/XL 8.0.18
Crockery cupboards 220.8 cm high with glass front	XL 6.7.10 Front extension for base units	XL 3.0.3
Crockery cupboards 220.8 cm high, angled	XL 6.7.4 Front extension for tall units	XL 6.0.3-4
Crockery cupboards 233.8 cm high	XL 6.8.2 Front extension for wall units	XL 3.0.3/XL 5.1.10/XL 5.2.10/XL 5.2.22
Crockery cupboards 246.8 cm high	XL 6.8.6 Front filler 52 cm high	XL 3.1.6
Crockery cupboards 259.8 cm high	XL 6.8.10 Front filler 65 cm high	XL 3.1.14/XL 6.1.6
Cuisio cutlery organiser	ZU. GL/XL3/ZU. GL/XL5 Front material	ZU. GL75/ZU. XL74
Cushioned self-closing mechanism for "Le Mans" carousel shelves	XL 3.1.13 Fronts for electrical appliances 65 cm high	XL 3.1.11-12
Cutlery organisation system, solid oak design	ZU. GL/XL23-24 Fronts for electrical appliances 71,5 cm high	XL 3.2.16-18/XL 3.5.21
Cutout for control panel	XL 3.2.9/XL 3.3.12-13/XL 3.3.38/XL 3.5.10-11 Fronts for electrical appliances 78 cm high	XL 3.3.24-25/XL 3.8.5/XL 6.1.13-14
Cutout in rear carcass area	XL 6.0.2 Fronts for electrical appliances 84.5 cm high	XL 3.5.21-22
Cylinder lock for door	ZU.XL/GL30 Function change behind the front	XL 6.0.2
<b>D</b>	<b>G</b>	
Depth dimensions tall units	XL.24 Glass doors/models	XL.1.138
Diagonal corner base unit 78 cm high	XL 3.3.30-31 Glass finishes AKTIVglas G1	XL.1.139
Diagonal corner base units 71.5 cm high	XL 3.2.22-23 Glass finishes G2	XL.1.139-140/XL.2.40/XL.2.44
Diagonal corner base units 84.5 cm high	XL 3.5.27-28 Glass finishes G2S/G5S	XL.1.140
Diagonal sink base unit 71.5 cm high	XL 3.2.16 Glass Recess back panels	XL/GL 4.1.14
Diagonal sink base unit 78 cm high	XL 3.3.23 Glass versions	XL.1.138
Diagonal sink base unit 84.5 cm high	XL 3.5.20 Grip ledge on wall unit	XL 5.1.10/XL 5.2.10/XL 5.2.22/XL 5.3.14/XL 5.4.12
Diagonal wine rack	XL 3.3.35 H	
Dimension overview - base unit carcass height 84.5 cm	XL.26 Hailo Laundry Area accessories	XL 7.2.1/XL 7.2.7-8/ZU.XL/GL39
Dimensions overview - base unit carcass height 71.5 cm	XL.25 Hall cupboards and coat stands 194.8 cm high	XL 6.5.7/XL 7.1.18
Dimensions overview - base unit carcass height 78 cm	XL.25 Hall cupboards and coat stands 207.8 cm high	XL 6.6.8/XL 7.1.18
Door module	XL 8.0.3-4/XL 8.0.12-13/XL 8.1.2-3 Hall cupboards and coat stands 220.8 cm high	XL 6.7.9/XL 7.1.18
Door module / internal drawer	XL 8.0.8-12/XL 8.1.9-13 Handle arrangement	XL 2.44/XL.2.53-54/XL.2.57-58
Door module / internal pull-out	XL 8.0.8-12/XL 8.1.9-14 Handle collection	XL.20/XL.2.35-43
Door stops	ZU.XL/GL46 Handle G 029	XL 5.2.3/XL 5.2.12/XL 5.3.2
Drawer element	XL 3.1.1/XL 7.1.21/XL 8.0.18/XL 8.1.15 Hanging rail for wall units	ZU.XL/GL44
Drawer module	XL 8.0.5/XL 8.1.3 Heat shield	ZU.XL/GL25
Drawers and pull-outs of variable width	XL.7 Heat shields	XL 3.1.8/XL 3.2.9/XL 3.3.11/XL 3.5.9
Drawers/pull-outs	XL 6.0.8-9/XL 8.0.20-21/XL 8.1.17-18 Height compensation panel for dishwashers	XL 3.3.25/ZU.XL/GL30
Dresser bar unit with folding-lifting doors 113 cm	XL 5.7.2 Hob base units 39 cm high	XL 3.1.2
Dresser bar unit with folding-lifting doors 126 cm	XL 5.7.8 Hob base units 52 cm high	XL 3.1.5
Dresser unit above raised dishwasher	XL 6.1.14/XL 6.2.16-17/XL 6.3.14-16 Hob base units 65 cm high	XL 3.1.9
Dresser unit background filler	XL 5.7.22 Hob base units 71.5 cm high	XL 3.2.9-10
Dresser unit for microwave above raised dishwasher	XL 6.1.14/XL 6.2.16-18 Hob base units 71.5 cm high, 70.5 cm deep	XL 3.2.28
Dresser unit for tall units	XL 6.9.1-2/XL 7.2.7 Hob base units 78 cm high	XL 3.3.11-14
Dresser unit processing	XL 5.7.20 Hob base units 78 cm high, 70.5 cm deep	XL 3.3.38-40
Dresser unit shelves	XL 5.7.19/XL 7.6.7 Hob base units 84.5 cm high	XL 3.5.10-12
Dresser unit visible side	XL 5.7.22 Hob base units 84.5 cm high, 70.5 cm deep	XL 3.5.32-34
Dresser units	XL 5.7.2/XL 5.7.8/XL 5.7.16 Hob base units for hob extractors 78 cm high	XL 3.3.14-15
Dresser units 113 cm high	XL 5.7.1 Hob base units for hob extractors 84.5 cm high	XL 3.5.12-13
Dresser units 113 cm high with glass front	XL 5.7.1-2 Home Economics elements	XL 7.2.8/ZU.XL/GL39-40
Dresser units 113 cm high with roller shutters	XL 5.7.3 HOMETOOL	XL 7.3.3
Dresser units 119.5 cm high	XL 5.7.4 Housing for raised washing machine/dryer	XL 7.2.7
Dresser units 119.5 cm high with glass front	XL 5.7.5 HSTORY H-1001	XL 7.1.1
Dresser units 119.5 cm high with roller shutters	XL 5.7.6 HSTORY H-1002	XL 7.1.1
Dresser units 126 cm high	XL 5.7.7-8 HSTORY H-1003	XL 7.1.1
Dresser units 126 cm high with glass front	XL 5.7.8 HSTORY H-1004	XL 7.1.1
Dresser units 126 cm high with roller shutters	XL 5.7.9 HSTORY H-1005	XL 7.1.1
Dresser units 132.5 cm high	XL 5.7.10 HSTORY H-1006	XL 7.1.1
Dresser units 132.5 cm high with glass front	XL 5.7.11 HSTORY H-1007	XL 7.1.2
Dresser units 132.5 cm high with roller shutters	XL 5.7.12 HSTORY H-1008	XL 7.1.2
Dresser units 139 cm high	XL 5.7.13-14 HSTORY H-1009	XL 7.1.2
Dresser units 139 cm high with glass front	XL 5.7.14 HSTORY H-1010	XL 7.1.2
Dresser units 139 cm high with roller shutters	XL 5.7.15 HSTORY H-1011	XL 7.1.2
Dresser units 145.5 cm high	XL 5.7.16 HSTORY H-1012	XL 7.1.2
Dresser units 145.5 cm high with glass front	XL 5.7.17 I	
Dresser units 145.5 cm high with roller shutters	XL 5.7.18 IDM format	XL.15
Dressing room	XL 7.6.1-5/XL 7.6.8-9 Interior organisation for LEGRABOX Cusio drawers and pull-outs	ZU.XL/GL32
<b>E</b>	Interior organisation for LEGRABOX drawers and pull-outs	XL.8
easi© lighting	ZU. XL/GL70 Interior organisation for LEGRABOX drawers and pull-outs plastic	ZU. GL/XL1-3
Edging to fit	ZU. GL82/ZU. XL81 Interior organisation for LEGRABOX OrganiQ drawers and pull-outs	ZU. GL/XL4
Electric all-purpose slicer	ZU.XL/GL28 Internal drawer	XL 8.0.21/XL 8.1.18/ZU.XL/GL30
Electronic opening assistance for pull-outs Hailo Libero 3.0	XL 3.3.21/XL 3.5.18 Internal pull-out	XL 8.0.18/XL 8.1.15/ZU.XL/GL30




# table of contents

<b>L</b>		Pull-out shelf black	XL 3.3.36
Laminate	XL/GL 4.1.2/XL/GL 4.1.6	Pull-out tables	XL 7.1.21/XL 8.0.18/XL 8.1.15
Laminate cutlery organiser	ZU. GL/XL1-3	Purifying, boiling and chilling water	XL 3.2.16/XL 3.3.22/XL 3.5.19-20
Larder unit	XL 6.1.2-4/XL 6.3.3-5/XL 6.4.3-5	Push-fit shelf	XL 7.1.15/XL 9.0.8/XL 9.0.12
Larder unit 156 cm high	XL 6.2.3-6	Push-fit shelf 100 mm	XL 5.6.5/XL 9.0.19
Larder unit 194.8 cm high	XL 6.5.3-4/XL 6.5.6-7	Push-fit shelf substrate for shelves	ZU.XL/GL47
Larder unit 207.8 cm high	XL 6.6.4-7	Push-fit shelf, profiled	XL 9.0.9
Larder unit 220.8 cm high	XL 6.7.4-8	<b>Q</b>	
Larder unit for bottle crates	XL 7.2.2-3	Quality and Environment	XL16/XL20
Larder units 143 cm high, angled	XL 6.1.2	<b>R</b>	
Larder units 156 cm high, angled	XL 6.2.3	Real wood cutlery organiser 45.5 cm deep	ZU. GL/XL14
Larder units 168.8 cm high, angled	XL 6.3.3	Real wood cutlery organiser 55.5 cm deep	ZU. GL/XL15-16
Larder units 181.8 cm high, angled	XL 6.4.3	Real wood cutlery organiser 70.5 cm deep	ZU. GL/XL17
Larder units 194.8 cm high, angled	XL 6.5.3	Real wood cutlery organiser accessories	ZU. GL/XL18
Larder units 207.8 cm high, angled	XL 6.6.4	Real wood pull-out partitioning	XL 7.5.8/ZU. GL/XL19-20
Larder units 220.8 cm high, angled	XL 6.7.4	Recess back panels	XL 7.5.15/XL 9.0.3/XL 9.0.5/XL 9.0.7
Laundry sorter - tall unit	XL 7.2.1	Recess back panels, printed motif	XL/GL 4.1.14/XL/GL 4.1.17-18
Laundry tall unit	XL 7.2.2/XL 7.6.6	Recess backpanels printed motif	XL 20/XL 2.33-34
LED lighting	ZU. XL/GL64	Recess system	XL 7.5.14-16
LED lights	XL 5.7.21/ZU. XL/GL53-54	Recyclable material and recycling base unit	XL 7.2.1
LEGRABOX	XL 7	Recyclable material and recycling tall unit	XL 7.2.6
Legrabox side stabilization	ZU.XL/GL32	Reduction in carcass depth	XL 6.0.2
Liftboy	XL 7.1.21	Reduction in carcass height	XL 6.0.2
Lifting door module	XL 8.0.13/XL 8.1.5	Reduction in carcass width	XL 6.0.2
Light pelmet	XL 10.0.3	Refrigerator appliance aperture module	XL 8.0.16-17/XL 8.1.7-9
Lighting accessories	XL 9.0.3/XL 9.0.5/XL 9.0.7/XL 9.0.13/ZU. XL/GL53-55	Reinforcement profile for adjustable shelves 19 mm	ZU.XL/GL51
Lights - Emotion	XL 5.7.21/XL 7.6.1-5/XL 7.6.8/XL 9.0.2/XL 9.0.4/XL 9.0.6	Replacement part fronts	XL 3.1.8/XL 3.2.8/XL 3.3.9-10/XL 3.5.8
Living room furniture	XL 6.10.7-9	ROOMBASE	XL 7.3.4-5
Low-frame laminate cutlery organiser	ZU. GL/XL2	<b>S</b>	
<b>M</b>		SafetyBox	XL 6.10.5
Maximum dimensions	XL 2.49-58	Sealing profile transparent	ZU.XL/GL44
Metal cross-bars for base units	XL/GL 4.1.8/ZU.XL/GL26/ZU.XL/GL29	Service and ordering instructions	XL 15
Metal profile as steam guard for raised dishwashers	ZU.XL/GL31	SERVO-DRIVE flex for dishwasher	XL 3.3.26
Milling groove for wall units	ZU.XL/GL35-36	Set of 3 separating bars	XL 3.2.3/XL 3.3.4/XL 3.5.4
Module for refrigerator appliance aperture	XL 8.0.14-15/XL 8.1.5-7	Shelf supports	ZU.XL/GL44
Mounting wall	XL 5.6.2/XL 7.1.22	Shelf unit for stiles	XL 5.6.7
Multi-insert real wood	ZU. GL/XL16	Shoe cupboard	XL 7.2.3-6/XL 7.6.6
<b>N</b>		Side by Side	XL 6.6.23-24/XL 6.7.24
Non-slip mat /felt mat	ZU. GL/XL6-7	Sink carcass angled	XL 7.1.21
<b>O</b>		Sink carcasses 52 cm high	XL 3.1.5
Opening element for wide angle hinges	ZU.XL/GL41	Sink carcasses 65 cm high	XL 3.1.9-11
OrganiQ cutlery organiser	ZU. GL/XL4	Sink carcasses 71.5 cm high	XL 3.2.11-15
Oven aperture module	XL 8.0.13-15/XL 8.1.7	Sink carcasses 78 cm high	XL 3.3.15-22/XL 3.5.19
Oven housings 65 cm high	XL 3.1.8	Sink carcasses 84.5 cm high	XL 3.5.13-19
Oven housings 71.5 cm high	XL 3.2.9	SlideLine M fitting	XL 3.9.3/XL 5.8.3/XL 5.8.9/XL 6.10.9
Oven housings 78 cm high	XL 3.3.11	Sliding door system SlideLine M for panels and shelves	XL 9.0.16-17
Oven housings 84.5 cm high	XL 3.5.9	Sliding door system SlideLine M for recesses	XL/GL 4.1.19
Overview - Fronts	XL 17-19/XL 1.1-6	Sliding door system SlideLine M for wall units	XL 5.8.3-9
Overview ranges	XL 1.135/XL 1.9	Slim-line worktops 16 mm with thick edge	XL/GL 4.1.7-8
<b>P</b>		Smartframe wall shelf unit	XL 5.3.12/XL 7.1.11
Panel back wall	XL 7.1.14	Soft wax	ZU.XL/GL46
Panel brackets	XL 7.1.14	Solid oak design interior organization	XL 7.6.9-10/ZU. GL/XL20-22
Panel plinth	XL 9.0.12	Special finish	XL 3.0.2/XL 3.1.5/XL 3.1.11/XL 3.2.15/XL 3.3.21
Panel protector	XL 9.0.3/XL 9.0.5/XL 9.0.7/XL 9.0.13	Standard panel, 16 mm thick	ZU. GL82/ZU. XL81
Panel shelf 10 mm	XL 9.0.1	Standard panel, 19 mm thick	ZU. GL82/ZU. XL81
Panel shelf 16 mm	XL 5.3.12/XL 7.1.16/XL 9.0.2	Standard panel, 25 mm thick	ZU. GL82/ZU. XL81
Panel shelf 19 mm	XL 9.0.4	Stile shelf 100 mm	XL 9.0.18
Panel shelf 25 mm	XL 5.3.12/XL 7.1.16/XL 9.0.6	Stile untreated for finishing on site	XL 5.6.7
Panel shelf 25 mm, profiled	XL 9.0.9-10	Stiles 100 mm	XL 9.0.18
Panel shelf 50 mm	XL 9.0.10	Support legs	ZU.XL/GL32-33
Panels 10 mm	XL 9.0.1	Suspension cable for canopies	XL 10.0.2
Panels 16 mm	XL 9.0.2	<b>T</b>	
Panels 19 mm	XL 9.0.4	Table attachment	XL/GL 4.1.21-24
Panels 25 mm	XL 9.0.6/XL 9.0.16	TAKEAWAY stacking box	XL 3.3.36
Panels 25 mm, profiled	XL 9.0.10	TAKEAWAY wooden box tray element	XL 3.3.36
Panels 50 mm	XL 9.0.10-11	Tall shelf end units 143 cm	XL 6.1.12
Pantry Box for storing fruit and vegetables	ZU.XL/GL29	Tall shelf end units 156 cm	XL 6.2.14
Passage door element 194.8 cm high	XL 6.5.19-20	Tall shelf end units 168.8 cm	XL 6.3.13
Passage door element 207.8 cm high	XL 6.6.24-25	Tall shelf end units 181.8 cm	XL 6.4.14
Passage door element 220.8 cm high	XL 6.7.25	Tall shelf end units 194.8 cm	XL 6.5.22
Pilaster panels 100 mm	XL 9.0.26-27	Tall shelf end units 207.8 cm	XL 6.6.28
Pilaster plinth panels	XL 9.0.28	Tall shelf end units 220.8 cm	XL 6.7.28
Pilasters for country-house elements	XL 9.0.20-21	Tall shelf units 143 cm high	XL 6.1.12
Pilasters with moulded profile	XL 9.0.23-24	Tall shelf units 156 cm high	XL 6.2.14
Pilasters with moulded profile and lateral grooving	XL 9.0.25	Tall shelf units 168.8 cm high	XL 6.3.13
PIROUETTE	XL 7.3.6-7	Tall shelf units 181.8 cm high	XL 6.4.14
Planning advice – Planning assistance	XL 6.1.6/XL 27-28	Tall shelf units 194.8 cm high	XL 6.5.22
Planning check list	XL 29	Tall shelf units 207.8 cm high	XL 6.6.28
Plastic moulded part - sink drain pipe	ZU.XL/GL26	Tall shelf units 220.8 cm high	XL 6.7.28
Plinth base	XL 7.1.16	Tall unit 143 cm high with roller shutter	XL 6.1.7
Plinth foot	ZU.XL/GL30/ZU.XL/GL45	Tall unit 156 cm high with roller shutter	XL 6.2.8
Plinth panels	XL 3.8.6/XL 9.0.9/ZU. GL72/ZU. XL72	Tall unit 168.8 cm high with roller shutter	XL 6.3.7
Plinth panels for country-house elements	XL 9.0.22	Tall unit 181.8 cm high with roller shutter	XL 6.4.7
Plinth pedestal for fridges,	XL 3.3.26	Tall unit 194.8 cm high with roller shutter	XL 6.5.8
Pocketdoor element	XL 6.10.4-5	Tall unit 207.8 cm high with roller shutter	XL 6.6.10
Price index	XL 25/XL 30	Tall unit 220.8 cm high with roller shutter	XL 6.7.10
Processing worktops	XL 3.8.3/XL/GL 4.1.1-4/XL/GL 4.1.7/XL/GL 4.1.9-10	Tall unit accessories	XL 3.3.23/XL 3.5.20/XL 7.2.7-8/XL 7.6.4
Product information	XL 7/XL 9-14	Tall unit back cladding 130 cm high	XL 7.1.13
Pull-out module	XL 8.0.5-7/XL 8.1.3-5	Tall unit back cladding 143 cm high	XL 6.1.11
Pull-out shelf	XL 5.7.2/XL 5.7.5/XL 5.7.11/XL 5.7.14/XL 5.7.17/XL 6.1.76.3.7	Tall unit back cladding 156 cm high	XL 6.2.13

# table of contents

Tall unit back cladding 168.8 cm high	XL 6.3.12	Wall unit corner filler 65 cm high	XL 5.2.13
Tall unit back cladding 181.8 cm high	XL 6.4.12-13	Wall unit corner filler 78 cm high	XL 5.3.2
Tall unit back cladding 194.8 cm high	XL 6.5.21	Wall unit corner filler 91 cm high	XL 5.4.3
Tall unit back cladding 207.8 cm high	XL 6.6.27	Wall unit corner solution 65 cm	XL 5.2.13
Tall unit back cladding 220.8 cm high	XL 6.7.27	Wall unit corner solution 78 cm	XL 5.3.3
Tall unit background filler 143 cm high	XL 6.1.11	Wall unit corner solution 91 cm	XL 5.4.3
Tall unit background filler 156 cm high	XL 6.2.13	Wall unit end panel 39 cm high	XL 5.1.6
Tall unit background filler 168.8 cm high	XL 6.3.12	Wall unit end panel 52 cm high	XL 5.2.4
Tall unit background filler 181.8 cm high	XL 6.4.13	Wall unit end panel 65 cm high	XL 5.2.13
Tall unit background filler 194.8 cm high	XL 6.5.21	Wall unit end panel 78 cm high	XL 5.3.3
Tall unit background filler 207.8 cm high	XL 6.6.27	Wall unit end panel 91 cm high	XL 5.4.3
Tall unit background filler 220.8 cm high	XL 6.7.27	Wall unit front filler 104 cm high	XL 5.5.2
Tall unit corner filler 143 cm high	XL 6.1.10	Wall unit front filler 117 cm high	XL 5.5.4
Tall unit corner filler 156 cm high	XL 6.2.13	Wall unit front filler 130 cm high	XL 5.5.6
Tall unit corner filler 168.8 cm high	XL 6.3.11	Wall unit front filler 26 cm high	XL 5.1.2
Tall unit corner filler 181.8 cm high	XL 6.4.12	Wall unit front filler 39 cm high	XL 5.1.6
Tall unit corner filler 194.8 cm high	XL 6.5.21	Wall unit front filler 52 cm high	XL 5.2.3
Tall unit corner filler 207.8 cm high	XL 6.6.26-27	Wall unit front filler 65 cm high	XL 5.2.12
Tall unit corner filler 220.8 cm high	XL 6.7.27/XL 7.6.6	Wall unit front filler 78 cm high	XL 5.3.2
Tall unit front filler 143 cm high	XL 6.1.10	Wall unit front filler 91 cm high	XL 5.4.3
Tall unit front filler 156 cm high	XL 6.2.12	Wall unit front filler with front extension	XL 5.1.10/XL 5.2.10/XL 5.2.22/XL 5.3.14
Tall unit front filler 168.8 cm high	XL 6.3.11	Wall unit increased side depth 104 cm high	XL 5.5.3
Tall unit front filler 181.8 cm high	XL 6.4.12	Wall unit increased side depth 117 cm high	XL 5.5.5
Tall unit front filler 194.8 cm high	XL 6.5.21	Wall unit increased side depth 130 cm high	XL 5.5.6
Tall unit front filler 207.8 cm high	XL 6.6.26	Wall unit increased side depth 26 cm high	XL 5.1.4
Tall unit front filler 220.8 cm high	XL 6.7.27/XL 7.6.6	Wall unit increased side depth 39 cm high	XL 5.1.8
Tall unit increased side depth 130 cm high	XL 7.1.13	Wall unit increased side depth 52 cm high	XL 5.2.9
Tall unit increased side depth 143 cm high	XL 6.1.12	Wall unit increased side depth 65 cm high	XL 5.2.21
Tall unit increased side depth 156 cm high	XL 6.2.14	Wall unit increased side depth 78 cm high	XL 5.3.13
Tall unit increased side depth 168.8 cm high	XL 6.3.12	Wall unit increased side depth 91 cm high	XL 5.4.11
Tall unit increased side depth 181.8 cm high	XL 6.4.13	Wall unit intermediate filler 104 cm high	XL 5.5.2
Tall unit increased side depth 194.8 cm high	XL 6.5.22	Wall unit intermediate filler 117 cm high	XL 5.5.4
Tall unit increased side depth 207.8 cm high	XL 6.6.28	Wall unit intermediate filler 26 cm high	XL 5.1.2
Tall unit increased side depth 220.8 cm high	XL 6.7.28	Wall unit intermediate filler 39 cm high	XL 5.1.6
Tall unit spacefitter frame 143 cm high	XL 6.1.10	Wall unit intermediate filler 52 cm high	XL 5.2.3
Tall unit spacefitter frame 156 cm high	XL 6.2.12	Wall unit intermediate filler 65 cm high	XL 5.2.12
Tall unit spacefitter frame 168.8 cm high	XL 6.3.10	Wall unit intermediate filler 78 cm high	XL 5.3.2
Tall unit spacefitter frame 181.8 cm high	XL 6.4.12	Wall unit intermediate filler 91 cm high	XL 5.4.3
Tall unit spacefitter frame 194.8 cm high	XL 6.5.18-19	Wall unit sides	XL 5.1.3/XL 5.1.9/XL 5.2.9/XL 5.2.21/XL 5.3.13
Tall unit spacefitter frame 207.8 cm high	XL 6.6.24	Wall unit spacefitter frame 52 cm high	XL 5.2.3
Tall unit spacefitter frame 220.8 cm high	XL 6.7.24-25	Wall unit spacefitter frame 65 cm high	XL 5.2.12
Tall unit spacefitter frame with swivelling plinth 194.8 cm high	XL 6.5.19	Wall unit spacefitter frame 78 cm high	XL 5.3.2
Tall unit visible sides 130 cm high	XL 7.1.13	Wall unit spacefitter frame 91 cm high	XL 5.4.2
Tall unit visible sides 143 cm high	XL 6.1.12	Wall unit visible side 104 cm high	XL 5.5.3
Tall unit visible sides 156 cm high	XL 6.2.14	Wall unit visible side 117 cm high	XL 5.5.5
Tall unit visible sides 168.8 cm high	XL 6.3.12	Wall unit visible side 130 cm high	XL 5.5.6
Tall unit visible sides 181.8 cm high	XL 6.4.13	Wall unit visible side 26 cm high	XL 5.1.4
Tall unit visible sides 194.8 cm high	XL 6.5.22	Wall unit visible side 39 cm high	XL 5.1.8
Tall unit visible sides 207.8 cm high	XL 6.6.28	Wall unit visible side 52 cm high	XL 5.2.9
Tall unit visible sides 220.8 cm high	XL 6.7.28	Wall unit visible side 65 cm high	XL 5.2.21
Tall units in the same finish inside and outside	XL 6.0.5/XL 6.1.6/XL 6.2.8/XL 6.3.6	Wall unit visible side 78 cm high	XL 5.3.13
Through-door with pivot fitting for tall unit rows	XL 6.6.26/XL 6.7.26	Wall unit visible side 91 cm high	XL 5.4.11
TIP ON	ZU.XL/GL32	Wall unit with bar flap 39 cm high	XL 7.1.8
Top unit for sliding door element	XL 5.8.1	Wall unit with full-width bottom structural shelf	XL 5.1.10/XL 5.2.10/XL 5.2.22
Towel rail, chrome-plated	ZU.XL/GL25	Wall units in the same finish inside and outside	XL 5.1.2/XL 5.1.9/XL 5.2.9/XL 5.2.17
<b>U</b>		Wall units with glass fronts 26 cm high	XL 5.1.2-3/XL 7.1.9
Unit dimensions for Ballerina XL - half grid Base unit height 71.5 cm	XL.22	Wall units with glass fronts 39 cm high	XL 5.1.6-7/XL 7.1.9-10
Unit dimensions for Ballerina XL - half grid Base unit height 84.5 cm	XL.22	Wall units with glass fronts 52 cm high	XL 5.2.5-7/XL 7.1.9
Unit dimensions for Ballerina XL - height grid 13 cm	XL.21	Wall units with glass fronts 65 cm high	XL 5.2.14-16/XL 7.1.10
Upstand system	XL/GL 4.1.16	Wall units with glass fronts 78 cm high	XL 5.3.4-7
Utensils box	XL 3.3.35	Wall units with glass fronts 91 cm high	XL 5.4.4-6
<b>V</b>		Wall units, 104 cm high	XL 5.5.2
Vapour protector	XL 6.1.14/XL 6.2.18/XL 6.3.16/XL 6.4.16/XL 6.5.25-26	Wall units, 117 cm high	XL 5.5.4
Ventilation grille	XL/GL 4.1.20/ZU.XL/GL33	Wall units, 130 cm high	XL 5.5.6
<b>W</b>		Wall units, 26 cm high	XL 5.1.2
Wall shelf unit Smart Cube 39 cm high	XL 5.1.8/XL 5.3.11/XL 7.1.11	Wall units, 39 cm high	XL 5.1.5/XL 7.1.8
Wall shelf unit Smart Cube 78 cm high	XL 5.3.11/XL 7.1.11	Wall units, 52 cm high	XL 5.2.2-3/XL 7.1.8
Wall shelf units 104 cm high	XL 5.5.2	Wall units, 65 cm high	XL 5.2.11-12/XL 5.6.8/XL 7.1.8
Wall shelf units 117 cm high	XL 5.5.4	Wall units, 78 cm high	XL 5.3.1-2
Wall shelf units 26 cm high	XL 5.1.3	Wall units, 91 cm high	XL 5.4.2
Wall shelf units 39 cm high	XL 5.1.7	Warranty	XL 15
Wall shelf units 52 cm high	XL 5.2.7-8	Waste bin	XL 3.3.23/XL 3.5.20/ZU.XL/GL26-28
Wall shelf units 65 cm high	XL 5.2.18-20	Worktop accessories and aperture design	XL 9.0.7/XL/GL 4.1.20/ZU.XL/GL34
Wall shelf units 65 cm high, country house	XL 5.2.20/XL 5.3.10/XL 5.4.10	Worktop angled cut	XL/GL 4.1.1/XL/GL 4.1.3-4/XL/GL 4.1.9-10
Wall shelf units 78 cm high	XL 5.3.9-10	Worktop decors	XL.20/XL.2.17/XL.2.32/XL.2.45-48/XL.2.52
Wall shelf units 78 cm high, country house	XL 5.3.10-11	Worktops 25 mm with thick edge	XL/GL 4.1.9-10
Wall shelf units 91 cm high	XL 5.4.8-9	Worktops 38 mm with postformed edge	XL/GL 4.1.1-2
Wall shelf units 91 cm high, country house	XL 5.4.10	Worktops 38 mm with thick edge	XL/GL 4.1.3-4/XL/GL 4.1.9-10
Wall unit background filler 104 cm high	XL 5.5.3	Worktops 48 mm with thick edge	XL/GL 4.1.5-6
Wall unit background filler 117 cm high	XL 5.5.5	Y	
Wall unit background filler 130 cm high	XL 5.5.6	Y kitchen	XL 3.8.3
Wall unit background filler 26 cm high	XL 5.1.3		
Wall unit background filler 39 cm high	XL 5.1.9		
Wall unit background filler 52 cm high	XL 5.2.9		
Wall unit background filler 65 cm high	XL 5.2.21		
Wall unit background filler 78 cm high	XL 5.3.12		
Wall unit background filler 91 cm high	XL 5.4.11		
Wall unit corner filler 104 cm high	XL 5.5.2		
Wall unit corner filler 26 cm high	XL 5.1.2		
Wall unit corner filler 39 cm high	XL 5.1.6		
Wall unit corner filler 52 cm high	XL 5.2.4		
XL.4			





**Carcase interior decor:  
The details make  
all the difference**

**Both inside and outside:  
a PERFECT match!**



**Interior decor  
at no extra  
charge!**

Interior decor at no extra charge!  
With 26 standard carcass finishes into  
the bargain

Who could resist?

26 standard carcass finishes are available for both exterior and interior. Perfect not only on the outside, but there is also the same decor behind the fronts - practically perfect! For both wood tones and plain colours.



## Drawers and pull-outs with full extension

Depending on the carcass depth and width, drawers and pull-outs can be loaded with up to:

Sleek, stylish design with exquisitely smooth drawer action - that's LEGRABOX, the elegant box system by Blum. The matching AMBIA-LINE is a special internal organisation system that goes with the design. For a harmonious overall impression in all living spaces.

Drawers	Carcass depth	Carcass width	Load-bearing capacity
	34 cm	30-120 cm	max. 40 kg
	45.5 cm	30-120 cm	max. 40 kg
	55.5 cm	30-120 cm	max. 40 kg
	70.5 cm	30-120 cm	max. 70 kg
incl. Drawer			

Pull-outs	Carcass depth	Carcass width	Load-bearing capacity
	34 cm	30-120 cm	max. 40 kg
	45.5 cm	30-120 cm	max. 40 kg
	55.5 cm	30-60 cm	max. 40 kg
	55.5 cm	80-120 cm	max. 70 kg
	70.5 cm	30-120 cm	max. 70 kg
incl. pull-out			

### LEGRABOX pure ART



**LEGRABOX pure ART (LBPA)**  
The LEGRABOX pure ART system in the version ART offers the advantages of a full pull-out in conjunction with high-quality cushioning.

### LEGRABOX free ART



**LEGRABOX free ART (LBFA)**  
As a second alternative, the LEGRABOX free ART system is available in the version ART with glass inserts on the sides. It not only looks elegant, but is also practical at the same time.

LEGRABOX leads the way in technology. A new runner system offers even greater ease of movement - with minimal opening forces from the very first millimetre. The synchronisation of drawer runner and carriage provides a noticeably smooth transition to easy running. Even the frame contains plenty of technical expertise for a high level of functionality.

### LEGRABOX pure WOOD (LBW)



The LEGRABOX pure WOOD system with an elegant veneer is available as a special alternative. This combines the advantages of a full pull-out with high-quality cushioning. (at an extra charge)

Delivery of the drawer, also for show kitchens, from 01/01/2024

## Cushioning



All drawers and pull-outs can be closed gently and quietly. This is made possible by a high-quality cushioning system. All fitted kitchens are equipped with this system as standard.

## Drawers and pull-outs of variable width



Drawers and pull-outs - also internal drawers and internal pull-outs - are available in variable widths. From now on, every centimetre of the kitchen can be filled practically with drawers and pull-outs - whether they are 43 cm wide or 70 cm wide. All dimensions between 31 cm – 119 cm are available.

Note:  
available for:  
- base units.  
not available for:  
- designer fronts in glass groups G2,G2S, G5, G5S, G6  
- model-dependent glass fronts  
- handles N400, N475, N500, N700, N775, N900, N975  
- Aktiv Glas fronts  
available fronts: see Category 1

Drawers and pull-outs are available individually in widths from 31 to 119 cm.

# Interior organisation for drawers and pull-outs

## Consistent design

The slender, linear design of AMBIA-LINE continues the reduced style of LEGRABOX on the inside and harmonises beautifully with the colours and materials of the drawers and pull-outs.



Cutlery frame system, flexible  
Steel powder-coated  
Colour: orion grey matt

### Accessories:

AMBIA-LINE knife block. Up to nine knives may be fitted safely into the knife block. AMBIA-LINE foil dispenser - Clingfilm and aluminium foil pull out smoothly and are cut cleanly by the foil cutter.





# Chrome – fine and elegant!

The principles of high quality behind the fronts are also continued with the metal interior equipment. For this reason, the corner base units and larder pull-out units for example have high-quality, elegant chrome fittings.

In short:

All metal interior fittings have galvanised brilliant chrome plating.

And all for NO EXTRA CHARGE

Technology by

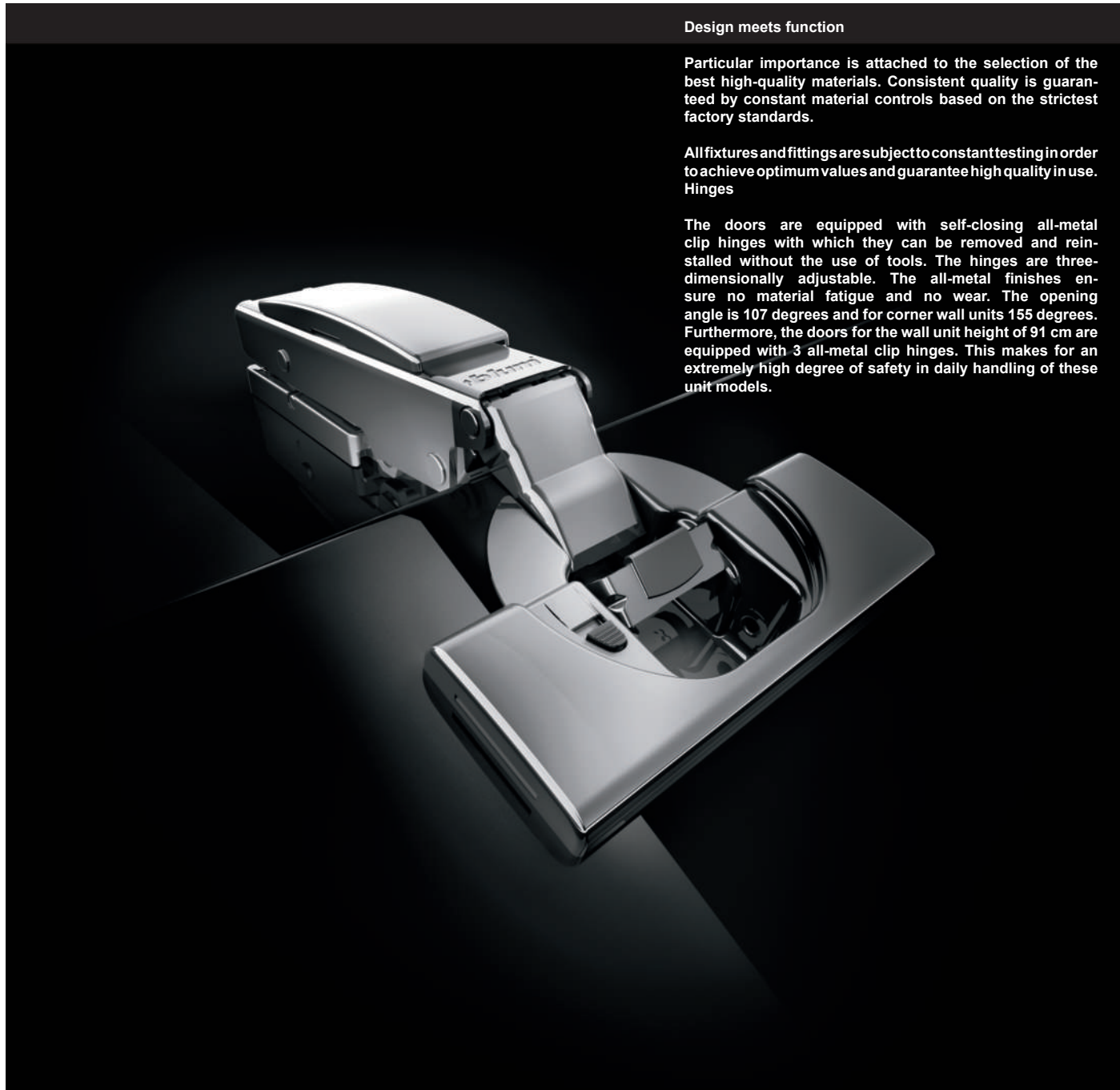


## Design meets function

Particular importance is attached to the selection of the best high-quality materials. Consistent quality is guaranteed by constant material controls based on the strictest factory standards.

All fixtures and fittings are subject to constant testing in order to achieve optimum values and guarantee high quality in use. Hinges

The doors are equipped with self-closing all-metal clip hinges with which they can be removed and reinstalled without the use of tools. The hinges are three-dimensionally adjustable. The all-metal finishes ensure no material fatigue and no wear. The opening angle is 107 degrees and for corner wall units 155 degrees. Furthermore, the doors for the wall unit height of 91 cm are equipped with 3 all-metal clip hinges. This makes for an extremely high degree of safety in daily handling of these unit models.



**Soft, gentle door closing**

The damping function is integrated into the hinges as standard and ensures that the doors always close softly and gently, no matter how energetically the doors are shut and irrespective of the size or weight of the door. So no more banging doors!



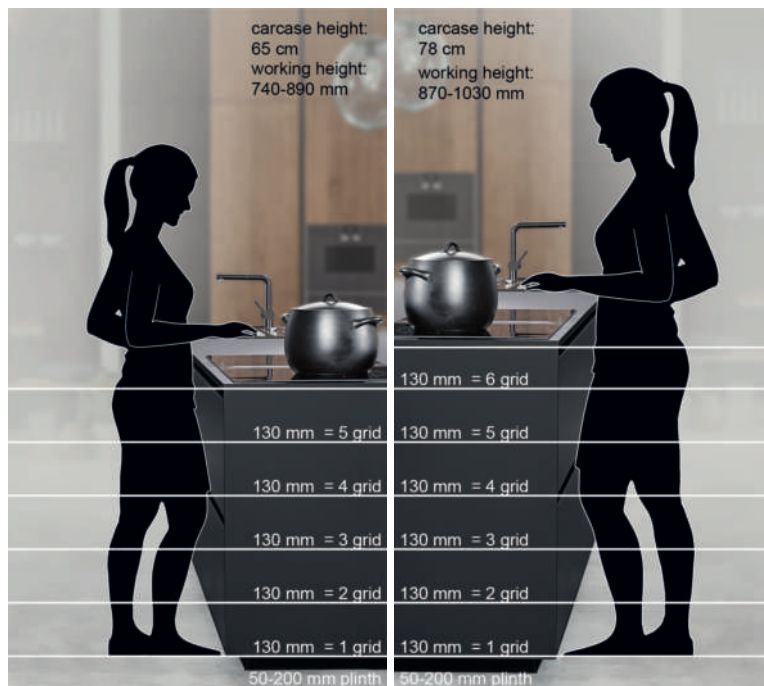
**Deactivating the damping**

To close small, lightweight doors softly and gently, the damping function only needs to be activated on one hinge.

The damping function can be deactivated simply by moving the slide switch on the hinge cup. Then simply close the door – it is now deactivated.

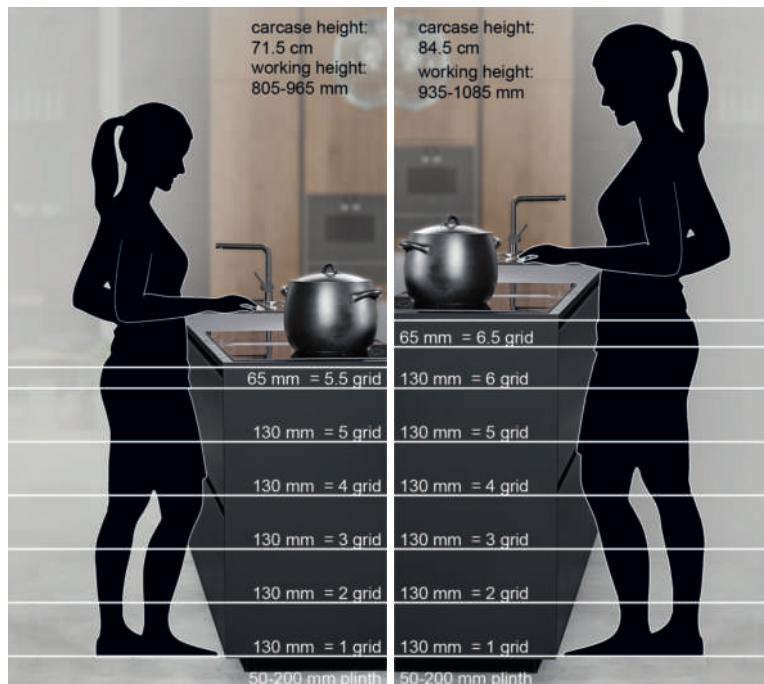


# Product information



## Perfect grid division of the carcass and recess heights

By working heights of 74 to 108.5 cm and working depths of up to 120 cm, it is possible to individually adapt the kitchen to the user and the different working sequences. An ergonomic working height is achieved as follows: Stand upright and bend your forearm by 90°. Elbow height  $\approx$  15 cm. If you are 170 cm tall and have an elbow height of 107 cm, the ergonomic working height for the sink and preparation areas is 92 cm.



## The perfect carcass height for old buildings

The carcass height 71.5 cm in half-grids offers the perfect storage space and matching height for old buildings with a sill height of 86 cm. Plinths of 10 cm or 15 cm height are used to achieve working heights of 85.5 or 90.5 cm. The carcass height 84.5 cm in the half-grid provides the perfect storage space and working height in combination, for example, with the plinth height of 5 cm..



### Carcass

#### Interior decor = exterior decor

The interior decor corresponds to the exterior decor for all standard carcass finishes.

Carcass; top/bottom shelves and adjustable shelves 19 mm thick, sides 16 mm

Front edge: ABS edging with PUR edge gluing 1.3 mm thick,

choice of 26 standard carcass finishes.

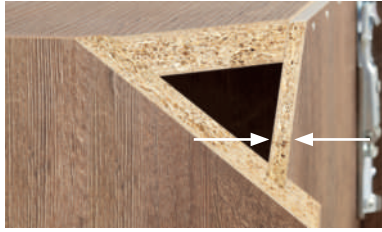
Carcass edges and centre panel matching the carcass exterior in colour.

Top and bottom shelves of the wall units in carcass finish (carcass all around).

The shelves are adjustable.



# Product information



## Back panels:

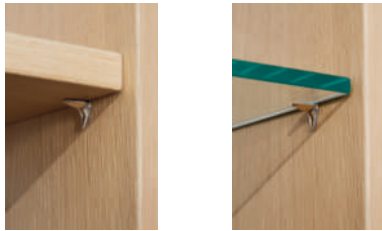
### Thickness of back panels: 8.0 mm, screwed together

Corner base units 80 x 80 cm/90 x 90 cm and 105 x 105 cm are delivered with a 3 mm thick back panel. For 70.5 cm and 55.5 cm carcass depth back panel rearward projection 3.2 cm. For 45.5 cm and 34 cm carcass depth back panel rearward projection 1.6 cm.



## Uniform joint appearance

The perfect grid division guarantees this uniform and elegant joint appearance. The joint width is 4 mm both horizontally and vertically.



## Shelf supports

The adjustable shelves are held by a metal shelf support and are firmly locked in place. Furthermore, the shelf support has a safety device against toppling and can withstand high loads in accordance with DIN.

Metal shelf supports are also provided for glass shelves.



## Wall unit hanging system

### Invisible support – wholly reliable and for heavy loads

The all-metal wall unit hanging system is mounted out of sight behind the back panel, and shines with versatility and excellent accessibility. The covered adjustment mechanism inside the unit is used for the 3-dimensional adjustment. The maximum nominal load (useful load) according to DIN 68840 (2003) is 650 N (=66.28 kg)/ piece (based exclusively on the unit hanging system in combination with one carcass). Using the safety screw as a safety catch prevents the wall units from detaching. The hanging rails in profiled steel are adjusted to the unit width.



## Corner base unit

The corner base units are available both with wooden carousel shelves and a chrome plated metal rail, and with dark grey laminate carousel shelves. Both versions have a non-slip effect as standard.



## Plinth panels

The standard heights are 5, 7.5, 10, 12.5, 15, 17.5 or 20 cm. Each base and tall unit has plinth feet in recyclable, impact-resistant and moisture-proof plastic. The plinth foot support is dowelled into the carcass base and engages with the upright carcass side. This displaces the weight on to the plinth foot, particularly with appliance tall units and cooker units, etc. The plinth panels are supplied with a soft PVC sealing profile which is attached under the plinth panel – this ensures an elegant join with the floor. The plinth corners are supplied matching the plinth colour.

The adjustability in height of the plinth foot from +20 mm to –10 mm allows simple and rapid adaptation to unevenness in the floor.

## All these points guarantee rapid and economical installation.

Ventilation grilles, in matching colour as far as possible, are included with appliance units at no extra charge.

Plinth panels in carcass finish are included in the base unit and tall unit price. For enhanced finishes in veneer, micro textured lacquer, velvet lacquer, high-gloss lacquer, matt lacquer or accessory decor, please refer to the price section.

# Product information



## Lighting elements

With the Up & Down system, the light not only shines downwards, but also into the unit interior. Particularly with modern models, this lighting option is a part of the optimisation of a kitchen design. The LED lighting system is available in widths of 45 cm, 50 cm, 60 cm, 80 cm, 90 cm, 100 cm and 120 cm – thus guaranteeing perfect illumination.



## Worktops

The centre of every fitted kitchen is the worktop. Fulfilment of the high demands in terms of quality, function and innovation to a special degree is a matter of course in this area too. A selection of 49 different worktop decors leaves nothing to be desired.

Testing of the stress group for laminate worktops is performed in accordance with DIN 68930 and DIN EN 438. All worktops are quality products from renowned German manufacturers. We only use worktops in HPL finish. The worktop laminate is resistant to common household acids and alkalis, is very hard wearing and therefore has a high, long-lasting utility value.

The underside is countersealed in order to avoid tensions.

A steam protection sheet / protective foil must be applied on site to the underside of the worktop over dishwashers. Worktop corners are joined via tongue and groove.



## Fronts

### Laminate fronts

Multiple-layer wooden particle boards serve as the base material and are coated on both sides with melamine resin, polymeric glass or decorative laminate.

### Foil fronts

MDF boards are used as the substrate. The front surface is jointlessly covered with foil. The foil quality and resistance corresponds to the respective current state of the art of the foil producer. As a result of rubbing the front, particularly at spots subject to stress, signs of use in the form of shiny areas may become visible with an unfavourable incidence of light. This phenomenon is normal and does not result in any functional impairment.



### Micro textured and velvet lacquer surfaces

High-quality 19 mm-thick MDF material is used as the substrate and is covered on both sides with a lacquerable base paper. The lacquered unit sections have a velvet-matt, finely textured surface. They are primarily used as front surfaces or in combination for accessory design. The surface resistance is classified as the stress group of kitchen furniture according to DIN 68930. The lacquer system fulfils the requirements according to DIN 68861, 53387 and 68930.



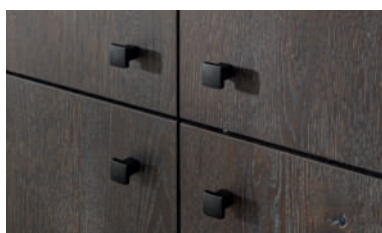
### High-gloss lacquered surfaces with 8 coats of lacquer

High-quality 19 / 22 mm-thick MDF material is used as the substrate and is covered on both sides with a lacquerable base paper. During the initial processing stages, the front sides, edges and rear sides are coated with filler several times. The surfaces of the front sides and the edges subsequently receive **4 crosscoat layers** of a polyurethane-based high-gloss lacquer. After a drying phase, this process is repeated with **4 layers of lacquer** based on acrylic high-gloss lacquer. The rear sides are coated with **4 crosscoat layers** of matt lacquer. The edges and the front sides are now buffed and dried for at least 4 days. The front sides of the front are sealed with a protective film.



### Matt lacquered surfaces produced in 12 stages

High-quality 19 mm-thick MDF material is used as the substrate and is covered on both sides with a lacquerable base paper. In the first stages, the edges are treated with an insulating primer and sanded before applying two layers of filling primer. The primed edges are allowed to dry and then sanded. In the next stage, both sides are sanded completely. The front is coated with two layers of coloured lacquer. This coating is allowed to dry before applying another two layers of coloured lacquer. The dried edges and fronts are then gently sanded and the front coated with clear lacquer to improve its resistance to metal marking. This is then followed by another drying phase.



## Wooden fronts

Only choice wood or veneer is used. The minimum thickness is 19 mm and is in solid wood or veneer depending on the finish. All front sections are protected with DD lacquer.

Since wood is a naturally grown raw material, differences in colour and texture naturally occur. Even differences in incidence of light may result in apparent changes in the appearance of the wood. Over the course of time, various different effects of light and sunshine may cause changes in colour.

Discrepancies in relation to samples and show kitchens cannot be avoided. Subsequent deliveries in the same texture or colour can only approximate the initial purchase.

# Product information



## Glass

Glass is a natural product. Natural raw materials are used for manufacture. Consequently, slight fluctuations in colour cannot be avoided. This may also apply to parts from one manufacturing batch. Our glass products correspond to the standards and guidelines DIN 1249-1, DIN 1249-3, DIN EN 572-4 and RAL-GZ 430 with regard to the manufacturing tolerances and quality characteristics.

All materials used for glass products have their own colours, determined by the raw materials, which may become more pronounced with increasing thickness. Coated glasses are used for functional reasons. Coated glasses also have their own colour. This intrinsic colour may be perceived differently in the view through it and/or looking directly at it. Fluctuations in the impression of the colour are possible due to the oxide content of the glass, the coating process, the coating and change in the glass thicknesses and the structure of the pane and cannot be avoided.

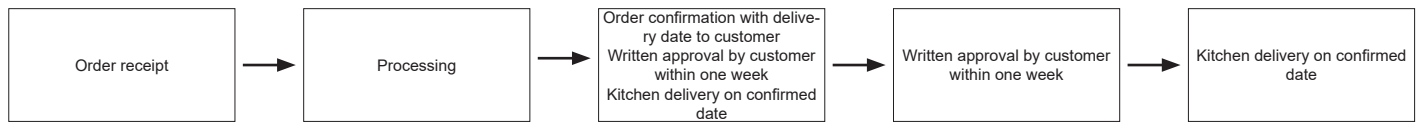
Note: Please observe a minimum distance of 100 mm between the outer edge of a gas hob and a glass recess back panel in order to avoid damage to the glass recess back panel.



# Service and ordering instructions

## Order processing for lacquer, veneer and solid wood fronts and accessories

All high-quality kitchens in the front and accessory finishes of lacquer, veneer and solid wood are manufactured on a commission basis in Germany. The quality of the various different materials requires a special order processing procedure. Processing begins after receipt of the order. The order confirmation with delivery date is subsequently sent to our customer for written approval. The delivery time for high-gloss lacquer and matt lacquer fronts (PG 5 and 7) and the corresponding accessories is **7 - 8 weeks**.



## Warranty

Our kitchen furniture is produced in accordance with state-of-the-art knowledge under constant quality control. The legal warranty periods apply from the beginning of the delivery date. The warranty covers defects occurring as a result of material or manufacturing errors, in spite of proper handling. We will remedy the defect by an additional delivery or repair of the defective parts. Installation and travel costs are not included in the warranty. An adequate substitute will be supplied in the case of end-of-range programmes and discontinued models. The warranty will not be extended by subsequent delivery or repair of individual components. The warranty guidelines stipulated by the respective manufacturer apply to merchandise. The warranty is assumed by the manufacturers. Damage due to incorrect installation and improper cleaning, care or handling of the kitchen furniture is excluded from the warranty. The colour of different surfaces and materials react differently depending on the type of light (daylight – artificial light). Deviations in colour and texture, even for colours with the same name, as a result of the aforementioned influences do not constitute any grounds for complaint.

## IDM format

All the data in this model list can be retrieved in IDM format for computer-aided kitchen planning. We cooperate with leading suppliers of kitchen planning software.

CARAT GmbH, D-63303 Dreieich  
Phone +49 (0) 6103 / 9308-0  
Fax +49 (0) 6103 / 9308-359

Compusoft AG, D-64668 Rimbach  
Phone +49 (0) 6253 / 9819-0  
Fax +49 (0) 6253 / 9819-11

SHD, D-56626 Andernach  
Phone +49 (0) 2632 / 295-0  
Fax +49 (0) 2632 / 295-100

## GENERAL

This model list is valid as from order receipt on 1st January 2024. The previous list ceases to be valid on 31st December 2023. We reserve our rights for technical modifications, minor discrepancies in the dimensions and finishes in addition to printing errors, inaccuracies and modifications related to prices and technology.

# Care instructions



## EKO-PUNKT

### IM AUFTRAG DER ZUKUNFT

#### Transport packaging

A waste disposal contract number TV000131 has been signed with the company RKT Recycling Kontor Transportverpackungen GmbH & Co. KG. This ensures that all the packaging materials concerned are processed correctly and that all the requirements of the Packaging Directive are met.



#### Quality knows no compromise

Strict tests with regard to safety, load-bearing capacity, material consistency and convenience in use are the basis that ensures our kitchens still continue to function safely and reliably even after many years of use. This high-quality standard is illustrated by the GS mark of the LGA QualiTest GmbH for all kitchens.



#### AMK data sheets

All furniture parts are produced in accordance with the quality requirements specified in the AMK data sheets.



Die Holzwerkstoffe entsprechen dem formaldehyd-reduzierten CARB2/TSCA P2-Standard.

#### Note on formaldehyde

The wood materials are in accordance with the reduced formaldehyde CARB2 / TSCA P2 standard and are environmentally sound, sustainable and ensure a healthy indoor climate.



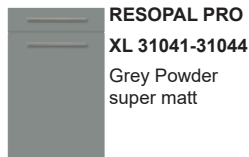
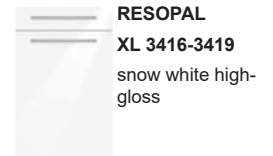
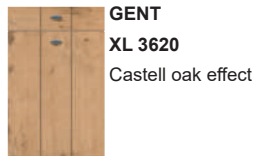
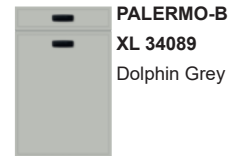
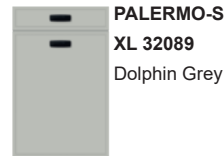
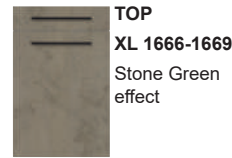
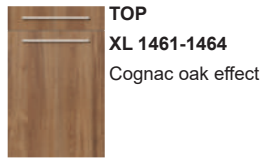
#### PEFC certificate

The company is PEFC-certified. This certification attests to the use of wood from sustainably managed forests and controlled sources in the manufacture of kitchen furniture. PEFC is short for Programme for the Endorsement of Forest Certification Schemes.

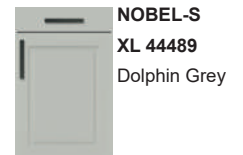
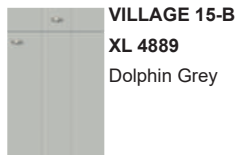
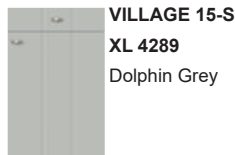
# End-of-range:

The end-of-range programmes are available until order receipt on 31st March 2025 - with the requirement for delivery being complete by 30th June 2025 (delivery date).

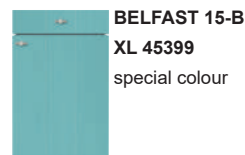
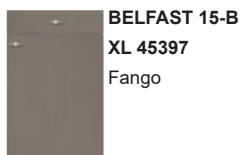
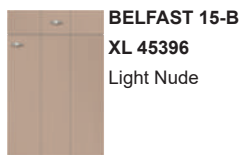
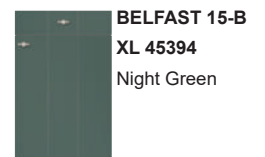
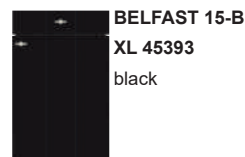
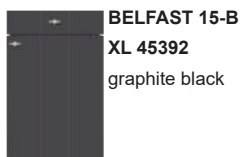
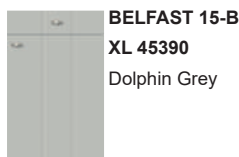
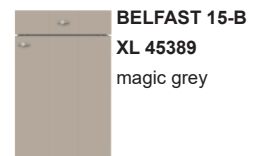
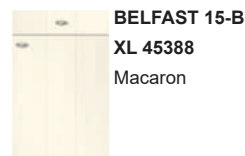
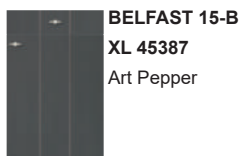
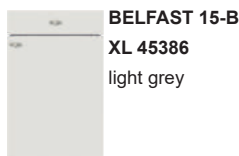
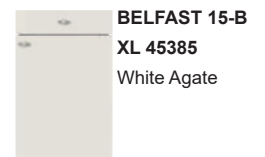
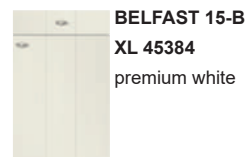
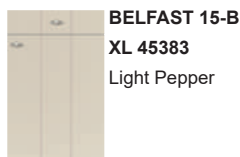
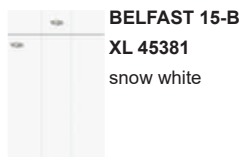
PG 1



PG 4



PG 4



# End-of-range:

The end-of-range programmes are available until order receipt on 31st March 2025 - with the requirement for delivery being complete by 30th June 2025 (delivery date).

PG 4



**MINERAL**  
**XL 40406**  
Smart concrete, dark

PG 5



**YORK-S**  
**XL 5189**  
Dolphin Grey



**CHALET-S**  
**XL 5289**  
Dolphin Grey



**YORK-B**  
**XL 5589**  
Dolphin Grey



**OPAL-H**  
**XL 5689**  
Dolphin Grey

PG 5



**CHALET-B**  
**XL 5789**  
Dolphin Grey



**NEW OPAL-M**  
**XL 52089**  
Dolphin Grey



**FENIX**  
**XL 5906**  
black super matt



**FENIX**  
**XL 5916**  
Grigio Londra super matt

PG 6



**VINO**  
**XL 61089**  
Dolphin Grey

PG 6



**NOBLESSE-S**  
**XL 62046**  
snow white



**NOBLESSE-S**  
**XL 62050**  
premium white



**NOBLESSE-S**  
**XL 62056**  
White Agate



**NOBLESSE-S**  
**XL 62059**  
Night Green



**NOBLESSE-S**  
**XL 62060**  
light grey



**NOBLESSE-S**  
**XL 62062**  
Art Pepper



**NOBLESSE-S**  
**XL 62065**  
Macaron



**NOBLESSE-S**  
**XL 62066**  
Light Nude



**NOBLESSE-S**  
**XL 62067**  
Fango



**NOBLESSE-S**  
**XL 62069**  
Light Pepper



**NOBLESSE-S**  
**XL 62084**  
magic grey



**NOBLESSE-S**  
**XL 62089**  
Dolphin Grey



**NOBLESSE-S**  
**XL 62095**  
graphite black



**NOBLESSE-S**  
**XL 62098**  
black



**NOBLESSE-S**  
**XL 62099**  
special colour

PG 6



**NOBLESSE-B**  
**XL 63046**  
snow white



**NOBLESSE-B**  
**XL 63050**  
premium white



**NOBLESSE-B**  
**XL 63056**  
White Agate



**NOBLESSE-B**  
**XL 63059**  
Night Green



**NOBLESSE-B**  
**XL 63060**  
light grey



**NOBLESSE-B**  
**XL 63062**  
Art Pepper



**NOBLESSE-B**  
**XL 63065**  
Macaron



**NOBLESSE-B**  
**XL 63066**  
Light Nude



**NOBLESSE-B**  
**XL 63067**  
Fango



**NOBLESSE-B**  
**XL 63069**  
Light Pepper



**NOBLESSE-B**  
**XL 63084**  
magic grey



**NOBLESSE-B**  
**XL 63089**  
Dolphin Grey



**NOBLESSE-B**  
**XL 63095**  
graphite black



**NOBLESSE-B**  
**XL 63098**  
black



**NOBLESSE-B**  
**XL 63099**  
special colour

# End-of-range:

The end-of-range programmes are available until order receipt on 31st March 2025 - with the requirement for delivery being complete by 30th June 2025 (delivery date).

## PG 7



**ROYAL-H**  
**XL 7646**  
snow white



**ROYAL-H**  
**XL 7650**  
premium white



**ROYAL-H**  
**XL 7656**  
White Agate



**ROYAL-H**  
**XL 7659**  
Night Green



**ROYAL-H**  
**XL 7660**  
light grey



**ROYAL-H**  
**XL 7661**  
Art Pepper



**ROYAL-H**  
**XL 7665**  
Macaron



**ROYAL-H**  
**XL 7666**  
Light Nude



**ROYAL-H**  
**XL 7667**  
Fango



**ROYAL-H**  
**XL 7669**  
Light Pepper



**ROYAL-H**  
**XL 7684**  
magic grey



**ROYAL-H**  
**XL 7689**  
Dolphin Grey



**ROYAL-H**  
**XL 7695**  
graphite black



**ROYAL-H**  
**XL 7698**  
black



**ROYAL-H**  
**XL 7699**  
special colour



**CERAMIC**  
**XL 7855**  
Calacatta silk



**CERAMIC**  
**XL 7860**  
basalt black satin



**CERAMIC**  
**XL 7865**  
Savoia anthracite

## PG 7

### End-of-range:

#### Carcase decor K

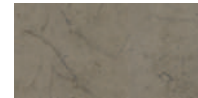


**K169F**  
Dolphin Grey



**K185S**  
Cognac oak reproduction

#### Decor group D



**D249F**  
Stone Green effect

#### Decor group I



**I242M**  
RESOPAL PRO grey powder



**I252M**  
RESOPAL PRO Dark Stone

#### Decor group L



**L043H**  
Graphite Black

#### Decor group A



**A169M**  
Dolphin Grey

#### Decor group S



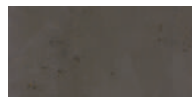
**S169P**  
Dolphin Grey

#### Decor group B



**B169F**  
Dolphin Grey

#### Decor group S

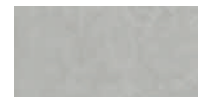


**SB260**  
Smart concrete dark

#### Decor group R



**R169H**  
Dolphin Grey



**R169W**  
Dolphin Grey

#### Decor group C



**C075M**  
FENIX black



**C208M**  
FENIX Grigio Londra

#### Decor group MP



**MP169**  
Dolphin Grey

#### Decor group H



**H169H**  
Dolphin Grey

# End-of-range:

The end-of-range programmes are available until order receipt on 31st March 2025 - with the requirement for delivery being complete by 30th June 2025 (delivery date).



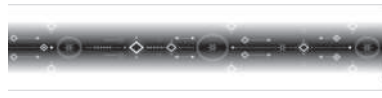
830  
RITZENHOFF Michal Sha-lev, digital print



865  
RITZENHOFF Kathrin Stockebrand, digital print



875  
RITZENHOFF Lenka Kühnertová, digital print



845  
RITZENHOFF Michaela Koch, digital print



870  
RITZENHOFF Nuno Ladeiro, digital print



880  
RITZENHOFF Sabine Röhse, digital print



860  
RITZENHOFF Virginia Romo, digital print

## End-of-range:

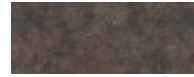
### Worktop decors



3153  
Cognac oak reproduction



3293  
Black stone look



3518  
Stone Nougat



3563  
RESOPAL PRO Dark Stone



3581  
Stone effect black/white



3594  
Rusty Underground



5200  
Calais Travertin



9251  
Stone Green effect



9500  
RESOPAL PRO grey powder

## End-of-range:

### Handles



K009  
black antique



K067  
grey antique



K071  
black matt



K178  
antique pewter



G061  
brown antique  
Drilling distance 96 mm



G068  
black antique



G100  
stainless steel look



G320VKH  
Aluminium handle Stainless steel finish matt brushed



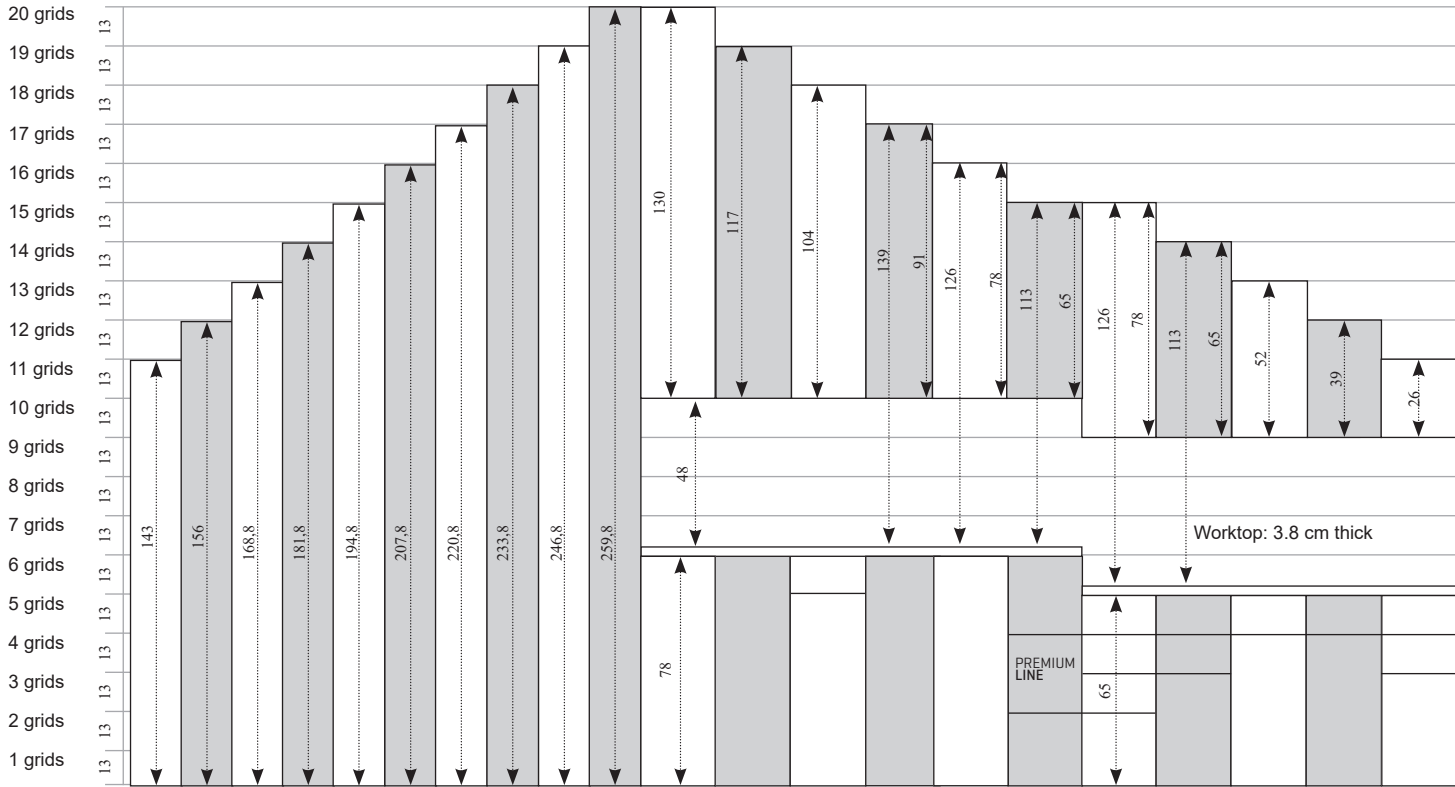
G370VKH  
Aluminium handle Stainless steel finish matt brushed



N500  
Grip ledge (top-mounted) aluminium stainless steel look

# Height dimensions grid 13 cm

## Unit dimensions for Ballerina XL - height grid 13 cm

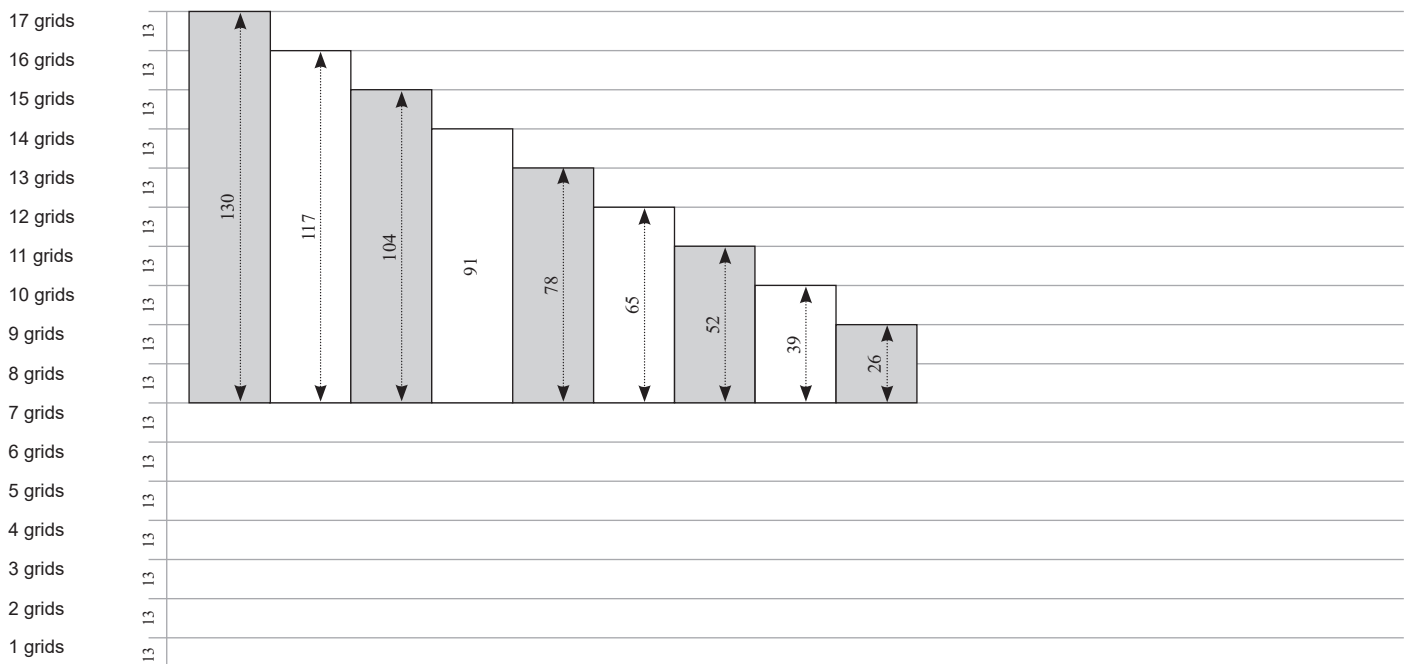


Height/cm

13 Raster

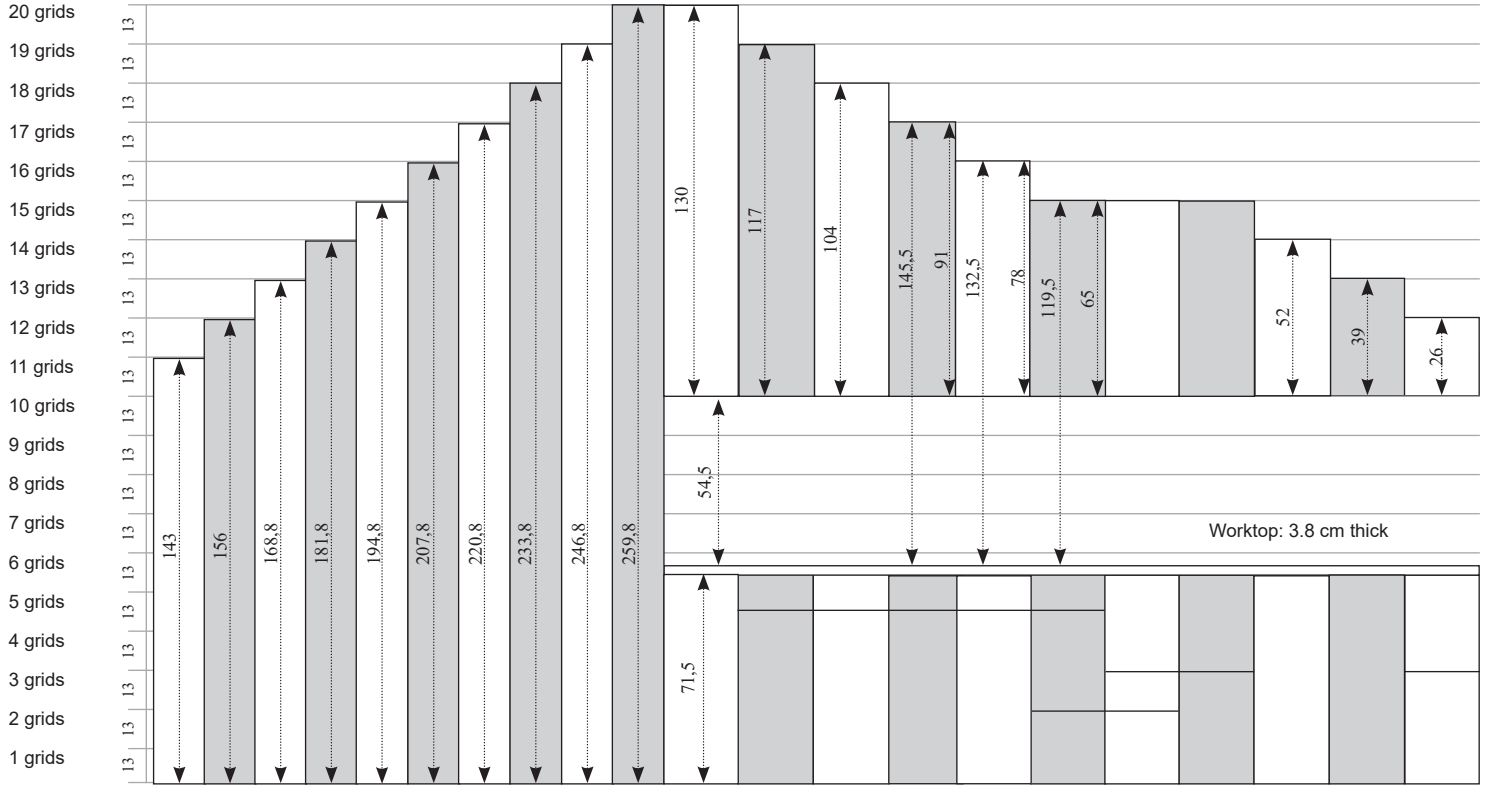
Unit	26	39	52	65	78	91	104	117	130	113	126	139	143	156	168,8	181,8	194,8	207,8	220,8	233,8	246,8	259,8	
Base units	X	X	X	X	X	X																	
Wall units	X	X	X	X	X	X	X	X	X														
Dresser units										X	X	X											
Tall unit													X	X	X	X	X	X	X	X	X	X	X

## Overview wall unit heights



# Height dimensions - half grid

Unit dimensions for Ballerina XL - half grid Base unit height 71.5 cm



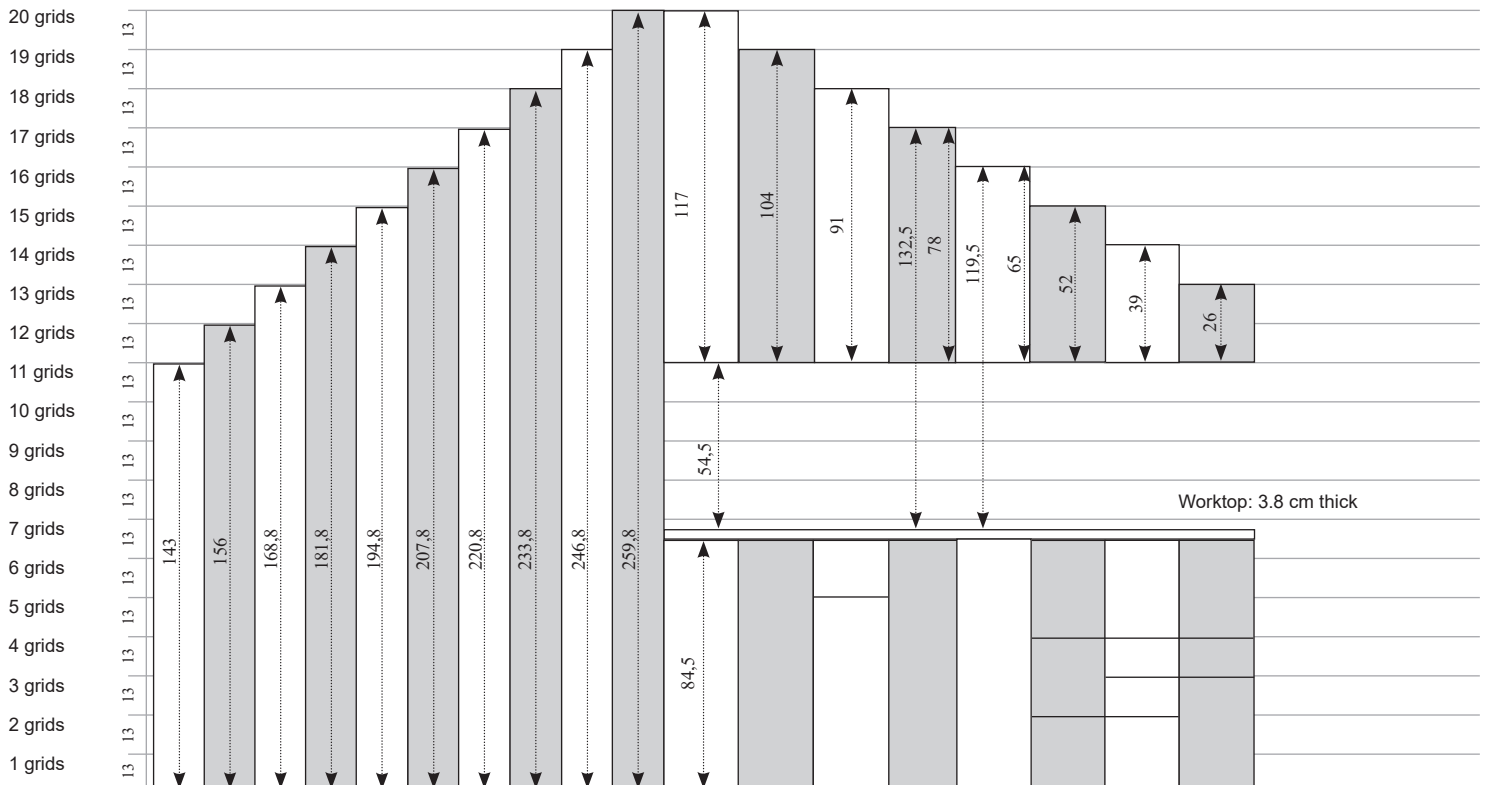
Height/cm

Halbes Raster

Unit	26	39	52	65	71,5	84,5	104	117	130	119,5	132,5	145,5	143	156	168,8	181,8	194,8	207,8	220,8	233,8	246,8	259,8	
Base units	X	X	X	X	X	X																	
Wall units	X	X	X	X			X	X	X														
Dresser units										X	X	X											
Tall unit													X	X	X	X	X	X	X	X	X	X	X

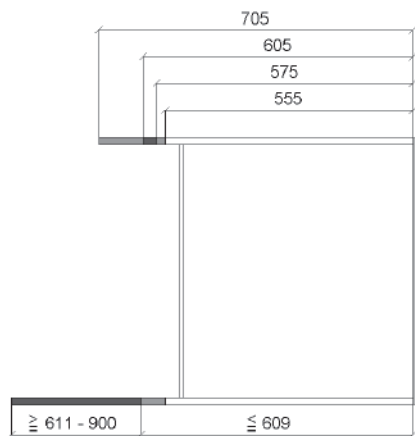
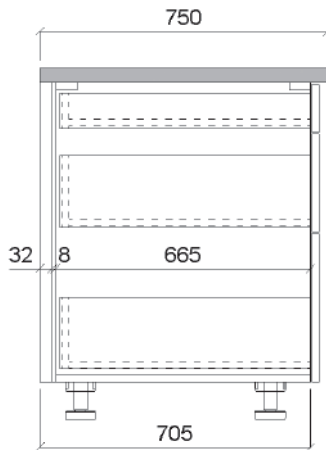
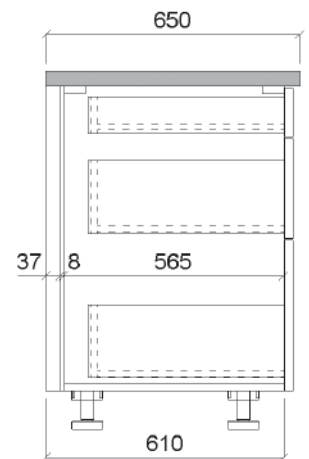
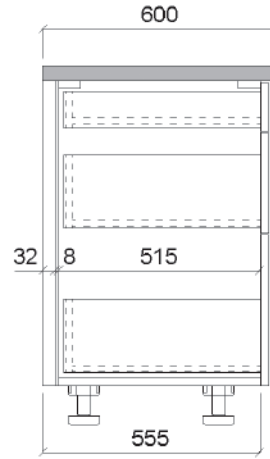
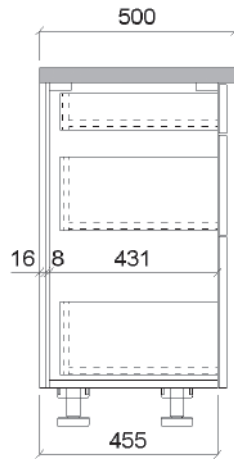
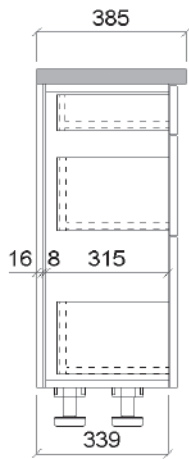
Unit dimensions for Ballerina XL - half grid Base unit height 84.5 cm

LINE E





# Depth dimensions Base units



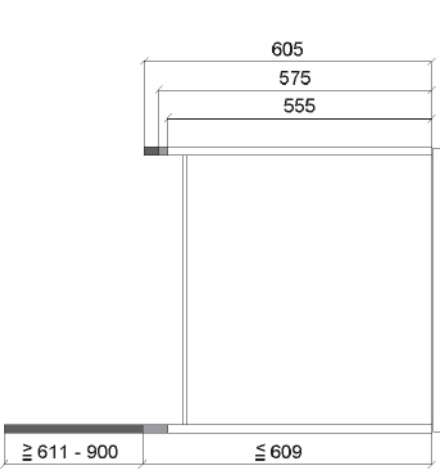
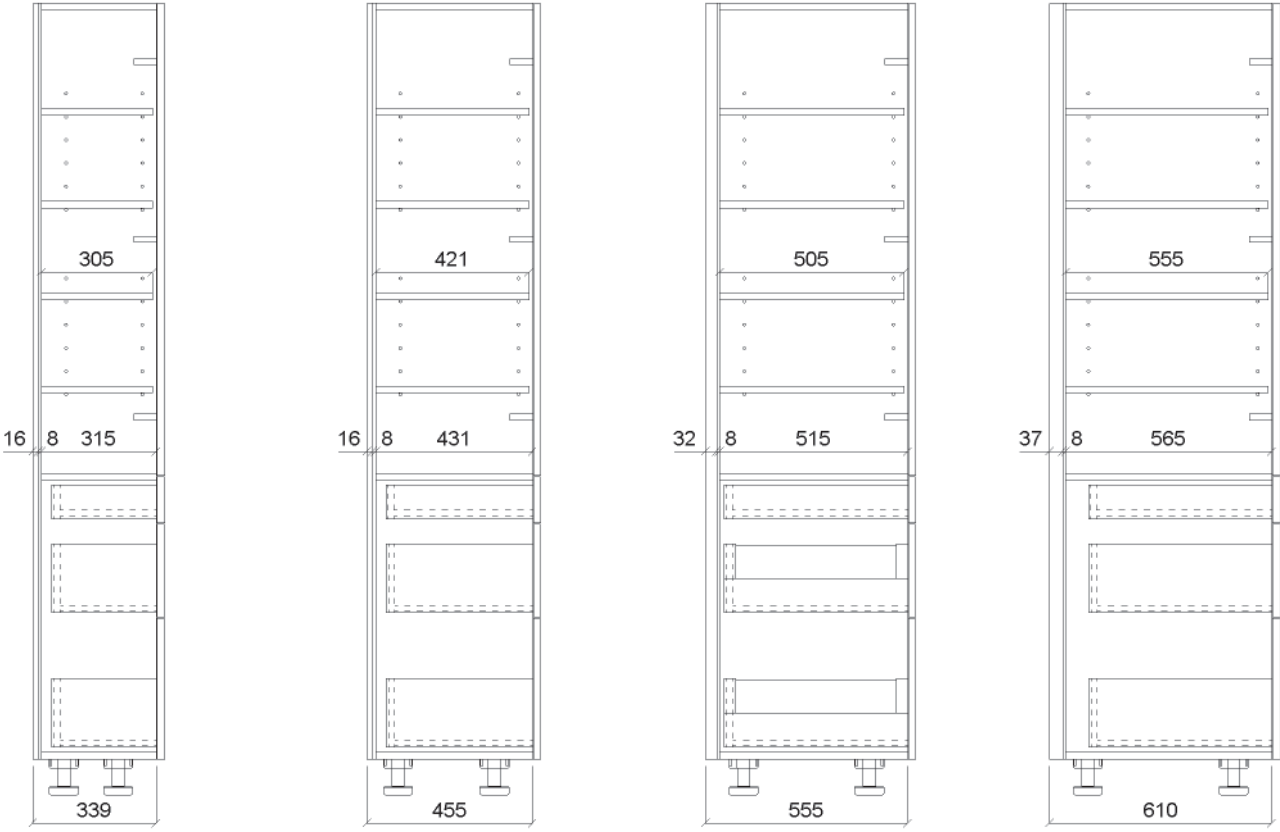
**Side depths USV..** (fixed size not variable)

**Side depths USVT..** (variable)



The carcass depths 33.9/45.5/61.0 are calculated for unit models of identical construction at **no extra charge** to the standard carcass depth **55.5 cm**.

# Depth dimensions tall units



**Side depths GSV.. (fixed size not variable)**

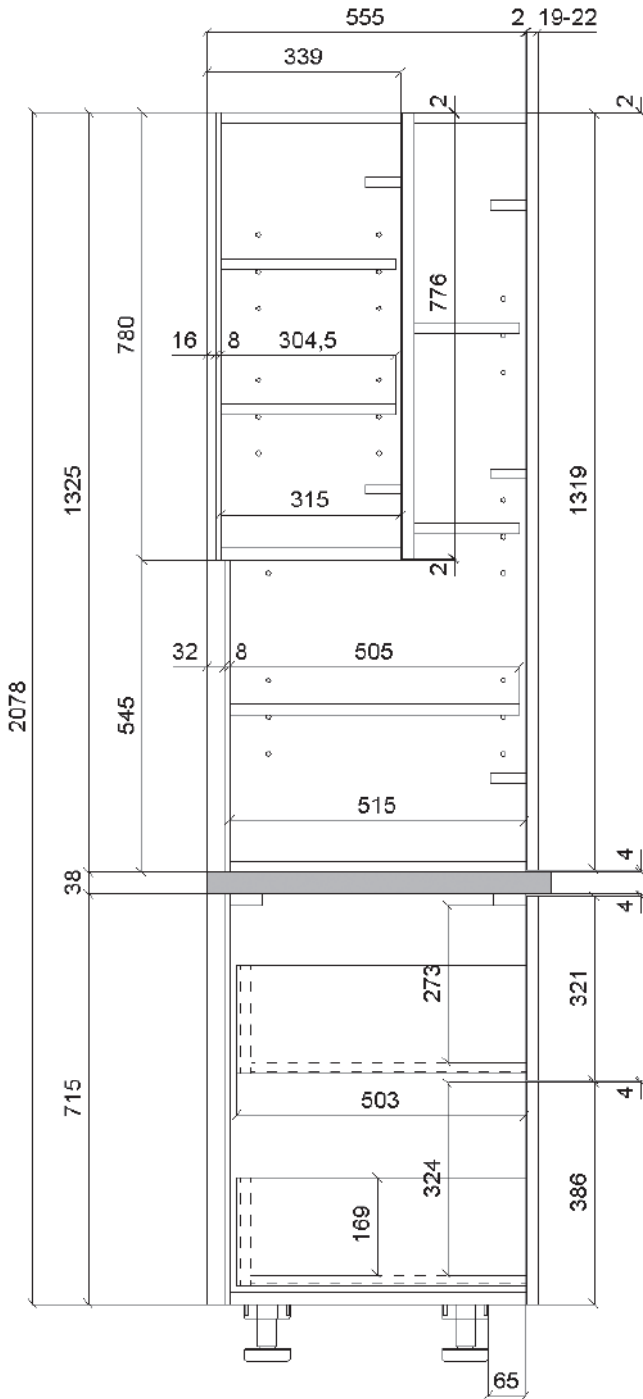
**Side depths GSVT.. (variable)**

The carcass depths 33.9/45.5/61.0 are calculated for unit models of identical construction at **no extra charge** to the standard carcass depth **55.5 cm**.

# Dimensions overview - base unit carcass height

## legrabox pull-out system

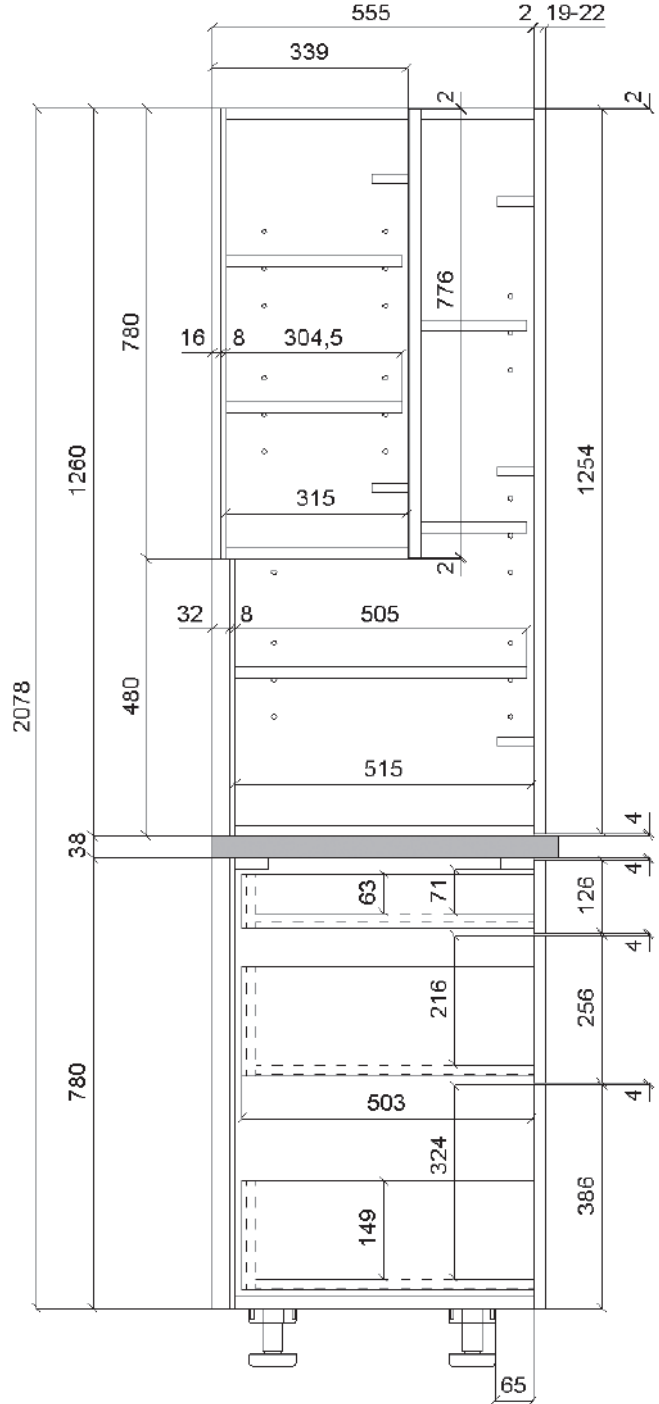
Carcass height 71.5 cm



\* Plinth feet with plinth  
 block set back towards the carcass rear side with:  
 Carcass depth 339 mm: 45 mm  
 Carcass depth 455 mm: 45 mm  
 Carcass depth 555 mm: 65 mm  
 Carcass depth 610 mm: 70 mm  
 Carcass depth 705 mm: 65 mm

## legrabox pull-out system

Carcass height 78 cm

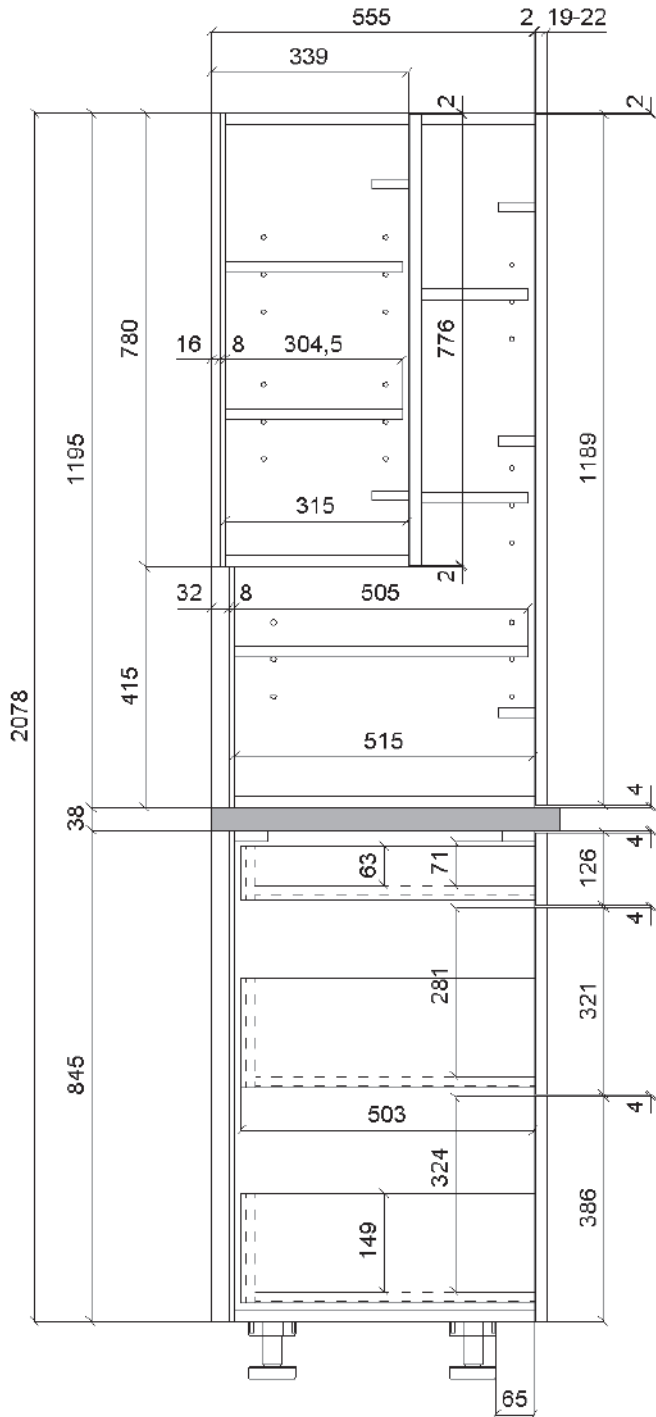


\* Plinth feet with plinth  
 block set back towards the carcass rear side with:  
 Carcass depth 339 mm: 45 mm  
 Carcass depth 455 mm: 45 mm  
 Carcass depth 555 mm: 65 mm  
 Carcass depth 610 mm: 70 mm  
 Carcass depth 705 mm: 65 mm

# Dimensions overview - base unit carcass height

legrabox pull-out system

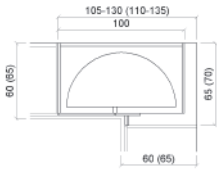
Carcass height 84.5 cm



\* Plinth feet with plinth  
 block set back towards the carcass rear side with:  
 Carcass depth 339 mm: 45 mm  
 Carcass depth 455 mm: 45 mm  
 Carcass depth 555 mm: 65 mm  
 Carcass depth 610 mm: 70 mm  
 Carcass depth 705 mm: 65 mm

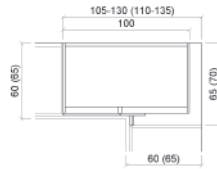
# Planning advice – Planning assistance

## Base units with carousel shelf



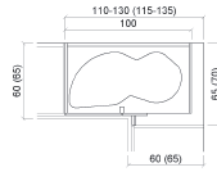
UE XXX XX 55 XX R  
USE XXX XX 55 XX R

## Base units with Adjustable shelves



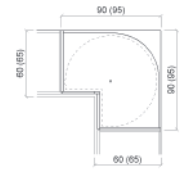
UE XXX XX 55 XX R  
USE XXX XX 55 XX R

## Base units with Le Mans



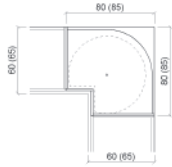
UE XXX XX 55 XX R

## Base units Carousel



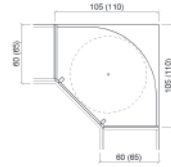
UEK 90 XX 72

## Base units with Carousel



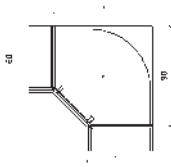
UEK 80 XX 72

## Diagonal corner base unit



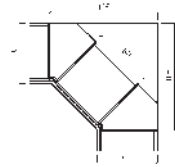
UED 105 XX XX  
USD 105 XX XX

## Diagonal corner base unit



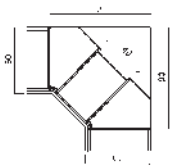
UED 90 XX XX  
USD 90 XX XX

## Base unit corner filler 135°



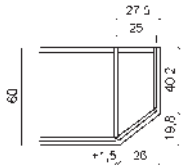
UPW 135 XX  
UH 60 XX 55 XX

## Base unit corner filler 135°



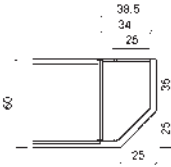
UPW 135 XX = 2,6 x 2,6 cm  
U 40 XX 55 XX

## Base shelf unit angled, 37.2°



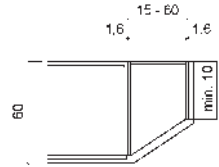
Worktop dimensions  
US 25 XX 55 XX  
URS 25 XX 55 XX  
Worktop overhang 2.5 cm

## Base shelf end unit



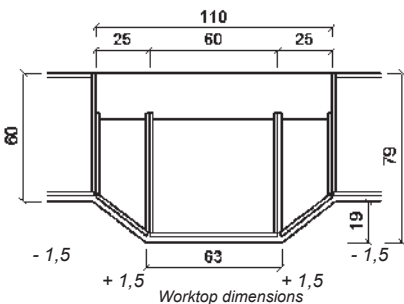
Worktop dimensions  
URA 25 XX 55 XX  
URA 34 XX 55 XX  
Worktop overhang 2.5 cm

## Base shelf end unit



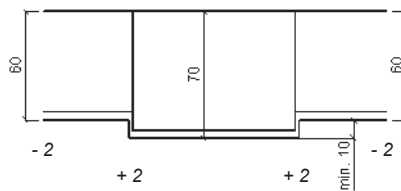
Worktop dimensions  
URS 25 XX 55 XX  
URS 34 XX 55 XX  
Worktop overhang 2.5 cm

## Worktop dimensions



US 25 XX 55 XX  
URS 25 XX 55 XX  
UH 60 XX 55 XX

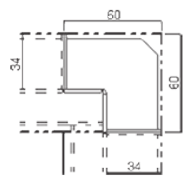
## Worktop dimensions



Worktop dimensions

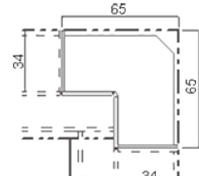
# Planning advice – Planning assistance

## Corner wall unit



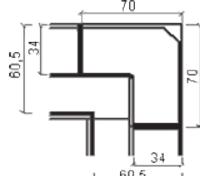
HE 60 XX 34 70 HRE 60 XX 34 X

## Corner wall unit



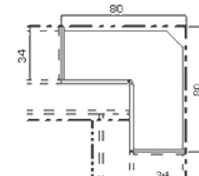
HE 65 XX 34 70 R/L

## Corner wall unit



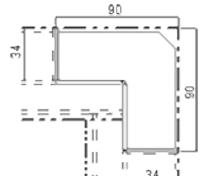
HE 70 XX 34 75 R/L

## Corner wall unit



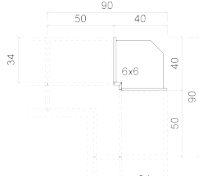
HE 80 XX 34 75 R/L

## Corner wall unit



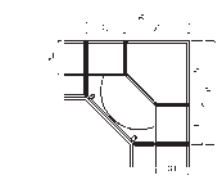
HE 90 XX 34 75 R/L

## Wall unit corner filler



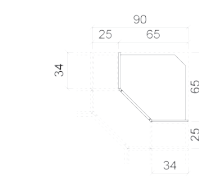
H 50 XX 34 XX R  
HPW 26 XX  
H 50 XX 34 XX L

## Diagonal corner wall unit



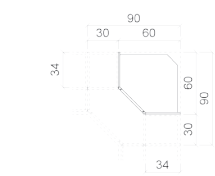
H 40 XX 3 XX R  
HDD/HDE 65 XX XX R/L  
H 40 XX 34 XX L

## Diagonal corner wall unit



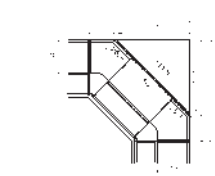
H 25 XX 34 XX R  
HDD/HDE 65 XX XX R/L  
H 25 XX 34 XX L

## Diagonal corner wall unit



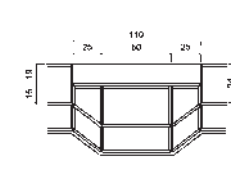
H 30 XX 34 XX R  
HDE 60 XX XX R/L  
H 30 XX 34 XX R

## Diagonal corner wall unit



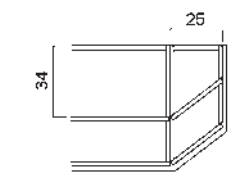
HRE 26 XX 34 X  
HDI 60 XX 34 X  
HRE 26 XX 34 X

## Wall unit for cooker hoods with Corner wall shelf unit



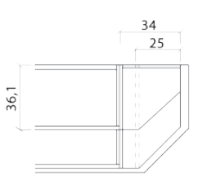
HS 25 XX 34 70 L  
HDI 60 XX 34 X  
HS 25 XX 34 70 R

## Wall unit angled by 37.2°



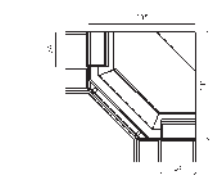
HS 25 XX 34 70 R

## Wall shelf end unit



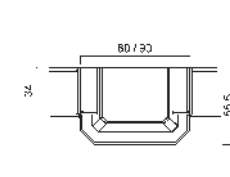
HRA 25 XX 36 X  
HRA 34 XX 36 X

## Canopy hood for corner solution



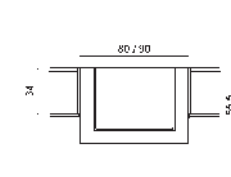
DEE XX

## Canopy hood



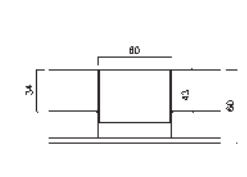
DE 80 XX  
DE 90 XX

## Canopy hood



DEG 80 XX  
DEG 90 XX

## Dresser unit with roller shutter



AJ 60 XX 43 XX X

# Planning check list

**Commission:** \_\_\_\_\_  
 Model 1: \_\_\_\_\_  
 Model 2: \_\_\_\_\_  
 Handle: \_\_\_\_\_  
 Carcase: \_\_\_\_\_

Drawer system: \_\_\_\_\_  
 LEGRABOX pure ART   
 LEGRABOX pureWOOD

Glass finish: \_\_\_\_\_  
 clear glass   
 Design: \_\_\_\_\_  
 Design door   
 Visible side: \_\_\_\_\_  
 Decor group: \_\_\_\_\_  
 Plinth height 1: \_\_\_\_\_  
 Plinth height 2: \_\_\_\_\_  
 Plinth finish: \_\_\_\_\_  
 Decor group: \_\_\_\_\_  
 Background filler finish: \_\_\_\_\_

Interior organisation: \_\_\_\_\_  
 Cutlery insert: \_\_\_\_\_  
 Panels 10 mm:  Decor group: \_\_\_\_\_  
 Panels 16 mm:  Decor group: \_\_\_\_\_  
 Panels 19 mm:  Decor group: \_\_\_\_\_  
 Panels 25 mm:  Decor group: \_\_\_\_\_  
 Panels 50 mm:  Decor group: \_\_\_\_\_  
 Stiles 100 mm:  Decor group: \_\_\_\_\_

**Shelf units:** \_\_\_\_\_  
 Decor group: \_\_\_\_\_

Recess back panel: \_\_\_\_\_  
 Pilaster: \_\_\_\_\_  
 Cornice: \_\_\_\_\_  
 Light pelmet: \_\_\_\_\_

**Worktop finish:** \_\_\_\_\_  
 16 mm  40 mm   
 25 mm  50 mm

Worktop decor 1: \_\_\_\_\_  
 Upstand: \_\_\_\_\_  
 Recess cladding: \_\_\_\_\_  
 Other: \_\_\_\_\_

**Electrical appliances:**  
 Manufacturer: \_\_\_\_\_  
 Cooker / Oven: \_\_\_\_\_  
 Hob: \_\_\_\_\_  
 Microwave: \_\_\_\_\_  
 Cooker hood: \_\_\_\_\_  
 Refrigerator: \_\_\_\_\_  
 Dishwasher: \_\_\_\_\_  
 Other appliances: \_\_\_\_\_

**Planning dimensions:**  
 Room dimensions and angles checked and indicated:   
 Doors and door handing, windows and elbow place height, radiators indicated:   
 Position of water supply, drain and cooker connection indicated:   
 Dimensions for table attachments, worktop radii, angling and angled cuts indicated:   
 Drawing drafted in scale: 1: \_\_\_\_\_

**Order no.:** \_\_\_\_\_  
 Colour 1: \_\_\_\_\_  
 Colour 2: \_\_\_\_\_  
 Handle position: A  B  C  D  M

LEGRABOX free ART   
 matt glas  black glass  Linea glass   
 Active glass door

Colour: \_\_\_\_\_  
 Colour: \_\_\_\_\_

Colour: \_\_\_\_\_

Panel colour, 10 mm: \_\_\_\_\_

Panel colour, 16 mm: \_\_\_\_\_

Panel colour, 19 mm: \_\_\_\_\_

Panel colour, 25 mm: \_\_\_\_\_

Panel colour, 50 mm: \_\_\_\_\_

Stile colour, 100 mm: \_\_\_\_\_

Colour: \_\_\_\_\_

Colour: \_\_\_\_\_

Colour: \_\_\_\_\_

Worktop edge, 40 mm: AP  APD

Worktop edge, 50 mm: AP5D

Worktop decor 2: \_\_\_\_\_

Colour: \_\_\_\_\_

Colour: \_\_\_\_\_

Colour: \_\_\_\_\_

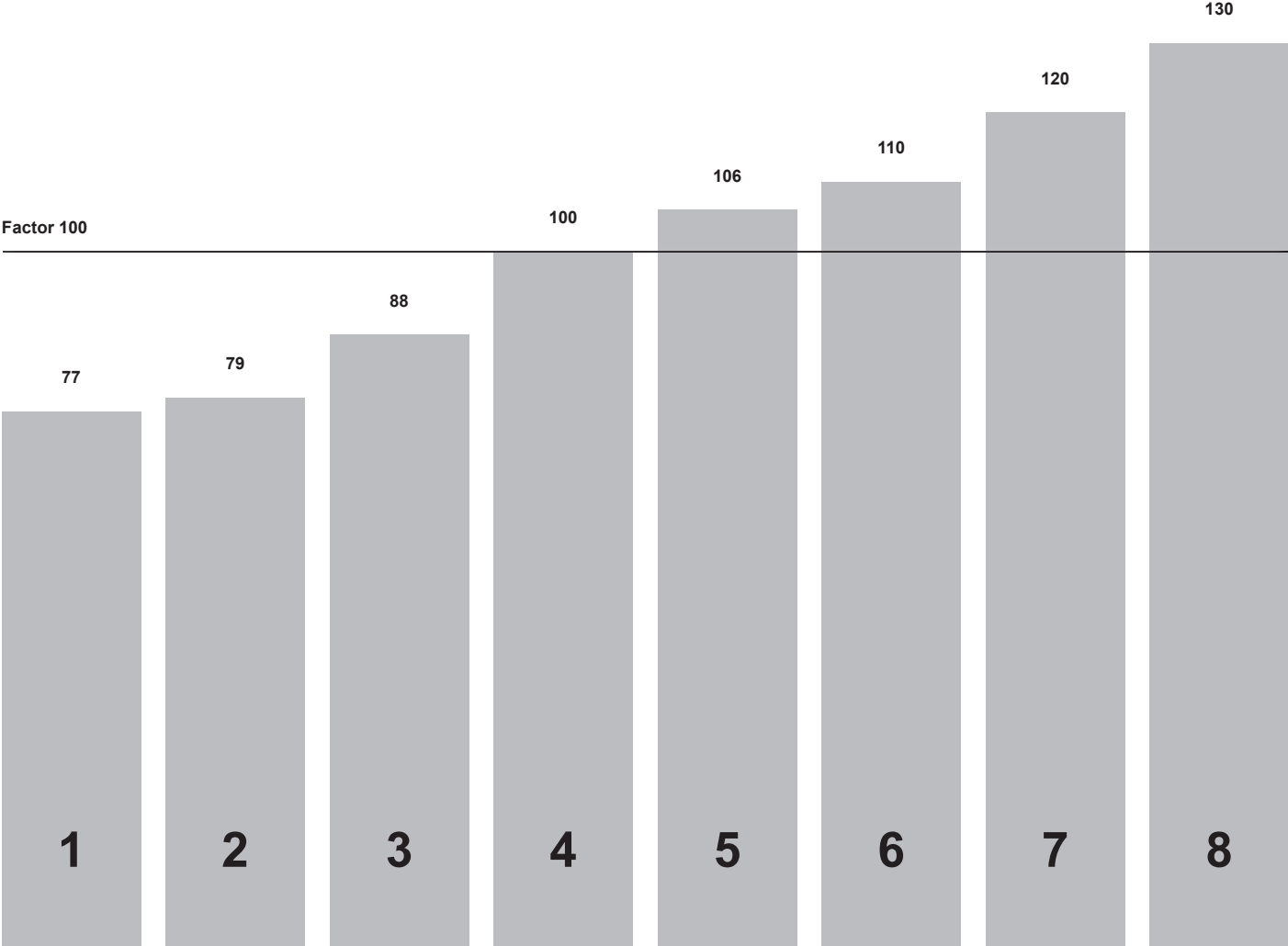
Control panel: \_\_\_\_\_

Freezer: \_\_\_\_\_

Company: \_\_\_\_\_ Date, planner: \_\_\_\_\_

# Price index

A functional L kitchen with 20 different unit models manufactured in serial production is taken as the basis for this comparison of the various price groups. The additional equipment available for an exclusive kitchen design in accordance with individual customer wishes such as veneer plinth panels, veneer visible unit sides, light pelmets and cornices etc. must be additionally calculated at an extra charge. Starting from price group 4 with a price index 100, the relationship with the other price groups can be seen. The multipliers are non-binding, but are helpful values for rapid offer comparisons.
















## Price group








# 1

## Model overview

### Product advantages:

-  **Soft Touch**
-  **Easy to clean**
-  **Impact-resistant**
-  **heat-proof**
-  **antibacterial**
-  **durable**
-  **micro-scratch resistant**
-  **Can be written on**
-  **easy-care**
-  **Anti-fingerprint**
-  **resistant to staining**
-  **extremely glossy**
-  **light resistant**

### Legend:

-  **Not available for carcass heights 71.5 cm and 84.5 cm.**
-  **This symbol indicates which models are available**
-  **This symbol indicates which models are available**
-  **This symbol indicates which series is not available**
-  **This symbol indicates which series is not available**

# Special lacquer colour



Custom lacquer finish to RAL or SIKKENS:

Custom lacquer finish from the RALClassic, RAL-DESIGN or SIKKENS colour systems are available in the same surface texture at an extra charge per order and colour. The additional price is charged independently of order volume, as from the first item on units and surrounding elements. If several colours are requested in one and the same order, the additional price for each colour must be taken into account:



RAL colour systems:

colours may only be specified from the RAL Classic or Design colour systems with the exception of the pearl, metallic and luminous colours.

SIKKENS colour system:

only from the SIKKENS 5051 Color Concept with the exception of pearl, metallic and luminous colours.

Colour specification:

please specify colour(s) when ordering,  
e.g. RAL 210 70 20

Note:

When ordering replacement items, slight colour variations from the RAL or SIKKENS colour swatches cannot be ruled out. Colour swatches are subject to a process of aging when exposed to light and no longer reflect a true rendition.

Colour swatches:

for colour swatches for RAL or SIKKENS, see:  
[www.RAL-Farben.de](http://www.RAL-Farben.de)  
[www.sikkens-shop.de](http://www.sikkens-shop.de)



Special lacquering COLOR NETWORK

Special lacquering from the COLOR NETWORK colour system are available in the same surface structure at an extra charge per order and colour. The extra charge is calculated independently of the scope of the order, from the first article on units and accessory elements. If several colours are desired in one order, the extra charge must be applied per each colour:

Colour info:

Please specify the colour(s) when ordering e.g. No.6 dive deep!

Note:

Minor colour variations in subsequent deliveries cannot be ruled out.  
You will find further information on the Color Network at [www.colornetwork.org](http://www.colornetwork.org)

Colour charts:

Colour samples available on request.



No. 1  
be rooted!

No. 2  
stay together!

No. 3  
give warmth!

No. 4  
pay attention!

No. 5  
feel jade!

No. 6  
dive deep!

No. 7  
come closer!

No. 8  
live simple!

## Ballerina colour concept - no extra charge



Sealbrown  
RAL 8019

Cristal red  
SIKKENS  
C0.60.30

Savona green  
SIKKENS  
K0.05.47

Victoria green  
RAL 180 30 10

Night Red  
SIKKENS  
C0.20.20

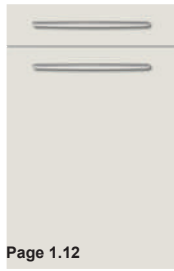
Blackblue  
SIKKENS  
U0.10.20

Jade, pastel  
RAL 7032

No. 8  
live simple!

# Overview - Fronts

**PG 1**



Page 1.12  
**TOP**  
**XL 1421-1424**  
 white agate matt



Page 1.13  
**TOP**  
**XL 1011-1014**  
 premium white



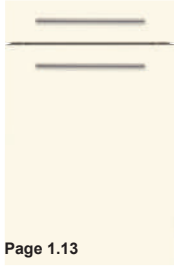
Page 1.13  
**TOP**  
**XL 1026-1029**  
 light grey



Page 1.13  
**TOP**  
**XL 1051-1054**  
 magic grey



Page 1.13  
**TOP**  
**XL 1056-1059**  
 graphite black



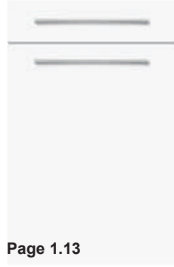
Page 1.13  
**TOP**  
**XL 1116-1119**  
 Macaron



Page 1.13  
**TOP**  
**XL 1181-1184**  
 stainless steel-coloured  
 (vertical grain pattern)



Page 1.13  
**TOP**  
**XL 1301-1304**  
 premium white matt



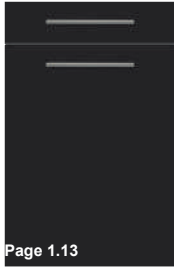
Page 1.13  
**TOP**  
**XL 1351-1354**  
 snow white matt



Page 1.15  
**TOP**  
**XL 1466-1469**  
 opal concrete effect



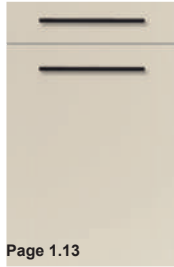
Page 1.15  
**TOP**  
**XL 1471-1474**  
 pearl grey concrete  
 effect



Page 1.13  
**TOP**  
**XL 1486-1489**  
 black



Page 1.15  
**TOP**  
**XL 1506-1509**  
 graphite concrete  
 effect



Page 1.13  
**TOP**  
**XL 1586-1589**  
 Light Pepper



Page 1.15  
**TOP**  
**XL 1616-1619**  
 brown concrete effect



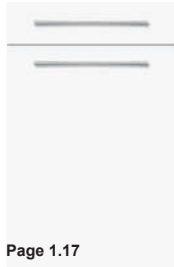
Page 1.13  
**TOP**  
**XL 1621-1624**  
 Art Pepper



Page 1.15  
**TOP**  
**XL 1626-1629**  
 Titan Steel



Page 1.13  
**TOP**  
**XL 1661-1664**  
 Light Nude



Page 1.17  
**TOP**  
**XL 1346-1349**  
 Snow White Gloss



Page 1.16  
**TOP**  
**XL 1251-1354**  
 gloss premium white



Page 1.13  
**TOP**  
**XL 1721-1724**  
 Fango



Page 1.14  
**TOP**  
**XL 1761-1764**  
 Natural sandstone  
 effect



Page 1.13  
**TOP**  
**XL 1771-1774**  
 Jade, pastel

# Overview - Fronts

PG 1



Page 1.19  
**TOP**  
**XL 1211-1214**  
 Castell oak effect



Page 1.19  
**TOP**  
**XL 1481-1484**  
 natural mammoth oak effect



Page 1.18  
**TOP**  
**XL 1606-1609**  
 Classic Oak effect



Page 1.19  
**TOP**  
**XL 1496-1499**  
 Piemont oak effect



Page 1.19  
**TOP**  
**XL 1556-1559**  
 natural mountain oak effect



Page 1.19  
**TOP**  
**XL 1641-1644**  
 Diamond Oak effect



Page 1.19  
**TOP**  
**XL 1651-1654**  
 Dark Maron effect



Page 1.19  
**TOP**  
**XL 1671-1674**  
 Black Oak effect



Page 1.19  
**TOP**  
**XL 1681-1684**  
 Seal Oak effect



Page 1.19  
**TOP**  
**XL 1691-1694**  
 Light oak, grooved look



Page 1.19  
**TOP**  
**XL 1701-1704**  
 Dark oak, grooved look



Page 1.19  
**TOP**  
**XL 1711-1714**  
 Royal Oak effect



Page 1.19  
**TOP**  
**XL 1731-1734**  
 Mountain Wood



Page 1.19  
**TOP**  
**XL 1741-1744**  
 Elegant walnut effect



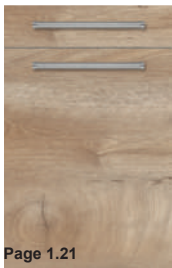
Page 1.20  
**TREND**  
**XL 1646-1649**  
 Diamond Oak effect



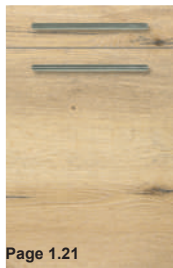
Page 1.21  
**TREND**  
**XL 1501-1504**  
 Piemont oak effect



Page 1.21  
**TREND**  
**XL 1521-1524**  
 Castell oak effect



Page 1.21  
**TREND**  
**XL 1526-1529**  
 mammoth oak effect



Page 1.21  
**TREND**  
**XL 1561-1564**  
 natural mountain oak effect



Page 1.21  
**TREND**  
**XL 1611-1614**  
 Classic Oak effect



Page 1.21  
**TREND**  
**XL 1656-1659**  
 Dark Maron effect



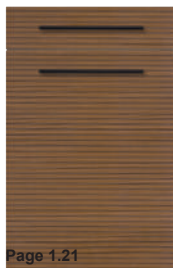
Page 1.21  
**TREND**  
**XL 1676-1679**  
 Black Oak effect



Page 1.21  
**TREND**  
**XL 1686-1689**  
 Seal Oak effect



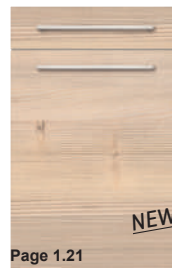
Page 1.21  
**TREND**  
**XL 1696-1699**  
 Light oak, grooved look



Page 1.21  
**TREND**  
**XL 1706-1709**  
 Dark oak, grooved look



Page 1.21  
**TREND**  
**XL 1716-1719**  
 Royal Oak effect



Page 1.21  
**TREND**  
**XL 1736-1739**  
 Mountain Wood



Page 1.21  
**TREND**  
**XL 1746-1749**  
 Elegant walnut effect

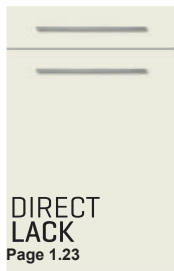
# Overview - Fronts

## PG 2



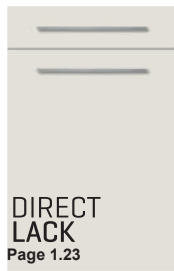
**DIRECT LACK**  
Page 1.22

**PUR**  
**XL 2621-2624**  
DIRECTLACK snow white matt lacquered



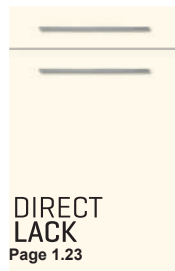
**DIRECT LACK**  
Page 1.23

**PUR**  
**XL 2626-2629**  
DIRECTLACK premium white matt



**DIRECT LACK**  
Page 1.23

**PUR**  
**XL 2631-2634**  
DIRECTLACK white agate matt



**DIRECT LACK**  
Page 1.23

**PUR**  
**XL 2636-2639**  
DIRECTLACK Macaron matt



**DIRECT LACK**  
Page 1.23

**PUR**  
**XL 2641-2644**  
DIRECTLACK black matt



**DIRECT LACK**  
Page 1.23

**PUR**  
**XL 2646-2649**  
DIRECTLACK graphite black matt



**DIRECT LACK**  
Page 1.23

**PUR**  
**XL 2656-2659**  
DIRECTLACK light pepper matt



**DIRECT LACK**  
Page 1.23

**PUR**  
**XL 2661-2664**  
DIRECTLACK art pepper matt



**DIRECT LACK**  
Page 1.23

**PUR**  
**XL 2676-2679**  
Light Nude DIRECT-LACK matt lacquered



**DIRECT LACK**  
Page 1.23

**PUR**  
**XL 2681-2684**  
DIRECTLACK Fango matt lacquered



**DIRECT LACK**  
Page 1.24

**EDITION**  
**XL 2701-2704**  
DIRECTLACK high-gloss snow white



**DIRECT LACK**  
Page 1.25

**EDITION**  
**XL 2706-2709**  
DIRECTLACK high-gloss premium white



**DIRECT LACK**  
Page 1.25

**EDITION**  
**XL 2711-2714**  
DIRECTLACK high-gloss white agate



**DIRECT LACK**  
Page 1.25

**EDITION**  
**XL 2721-2724**  
DIRECTLACK high-gloss Macaron



**DIRECT LACK**  
Page 1.25

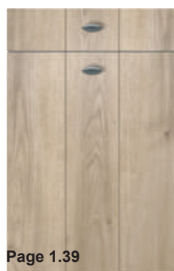
**EDITION**  
**XL 2746-2749**  
DIRECTLACK high-gloss light pepper



**DIRECT LACK**  
Page 1.25

**EDITION**  
**XL 2751-2754**  
Light Nude DIRECT-LACK high-gloss

## PG 3



Page 1.39

**GENT**  
**XL 3640**  
Diamond Oak effect



Page 1.38

**GENT**  
**XL 3625**  
Royal Oak effect



Page 1.32

**SHERWOOD**  
**XL 3036**  
Sherwood oak effect black



Page 1.33

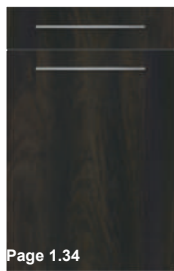
**SHERWOOD**  
**XL 3041**  
Sherwood oak effect sepia grey

## PG 3



Page 1.34

**RIVA**  
**XL 3101**  
Bordeaux oak effect



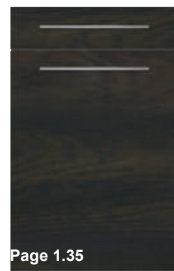
Page 1.34

**RIVA**  
**XL 3111**  
Burnt Wood effect



Page 1.35

**GARDA**  
**XL 3801**  
Bordeaux oak effect



Page 1.35

**GARDA**  
**XL 3806**  
Burnt Wood effect

# Overview - Fronts

PG 3



Page 1.36

**FRAME  
XL 3310**

Castell oak effect



Page 1.37

**FRAME  
XL 3344**

Sherwood oak effect  
black



Page 1.37

**FRAME  
XL 3345**

Sherwood oak effect  
sepia grey



Page 1.37

**FRAME  
XL 3347**

Bordeaux oak effect



Page 1.37

**FRAME  
XL 3357**

Royal Oak effect



Page 1.37

**FRAME  
XL 3359**

Classic Oak effect



Page 1.37

**FRAME  
XL 3361**

Diamond Oak effect



Page 1.37

**FRAME  
XL 3363**

natural mountain oak  
effect



Page 1.37

**FRAME  
XL 3368**

Piemont oak effect

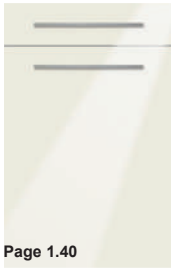


Page 1.37

**FRAME  
XL 3369**

natural mammoth oak  
effect

PG 3



Page 1.40

**MIAMI  
XL 3050**

Premium White High  
Gloss Lacq.

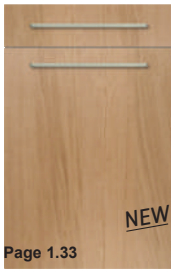


Page 1.41

**VIVA  
XL 3550**

premium white

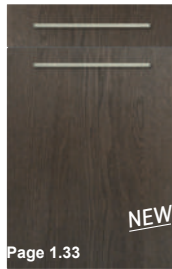
PG 3



Page 1.33

**PRIMEWOOD TOP  
XL 3526**

Gavi Oak Basic  
stained

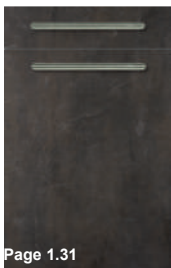


Page 1.33

**PRIMEWOOD TOP  
XL 3531**

Dark oak stained basic

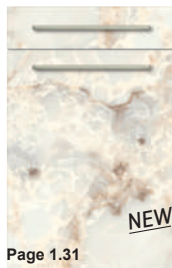
PG 3



Page 1.31

**HPL PRO  
XL 3001-3004**

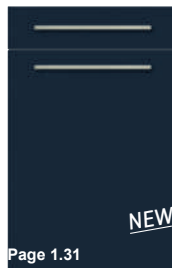
ferro black gold



Page 1.31

**HPL PRO  
XL 3011-3014**

Natural onyx effect



Page 1.31

**HPL PRO  
XL 3016-3019**

Navyblue



Page 1.31

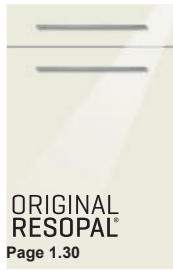
**HPL PRO  
XL 3191-3194**

Smoke Powder



# Overview - Fronts

**PG 3**



ORIGINAL  
RESOPAL®

Page 1.30

**RESOPAL  
XL 3211-3214**  
high-gloss premium  
white



ORIGINAL  
RESOPAL®

Page 1.26

**RESOPAL PRO  
XL 31006-31009**  
black super matt



ORIGINAL  
RESOPAL®

Page 1.27

**RESOPAL PRO  
XL 31001-31004**  
Jura Grey super matt



ORIGINAL  
RESOPAL®

Page 1.27

**RESOPAL PRO  
XL 31011-31014**  
Anthracite super matt



ORIGINAL  
RESOPAL®

Page 1.27

**RESOPAL PRO  
XL 31016-31019**  
Titanium grey super  
matt



ORIGINAL  
RESOPAL®

Page 1.27

**RESOPAL PRO  
XL 31021-31024**  
cool white super matt



ORIGINAL  
RESOPAL®

Page 1.27

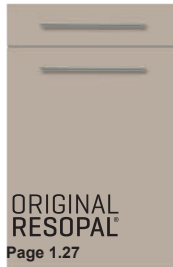
**RESOPAL PRO  
XL 31026-31029**  
Premium white super  
matt



ORIGINAL  
RESOPAL®

Page 1.27

**RESOPAL PRO  
XL 31031-31034**  
Light Powder super  
matt



ORIGINAL  
RESOPAL®

Page 1.27

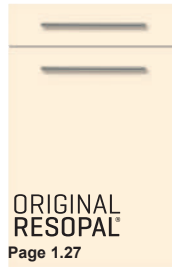
**RESOPAL PRO  
XL 31036-31039**  
Dark Powder super  
matt



ORIGINAL  
RESOPAL®

Page 1.27

**RESOPAL PRO  
XL 32001-32004**  
Moonlight Green  
super matt



ORIGINAL  
RESOPAL®

Page 1.27

**RESOPAL PRO  
XL 32011-32014**  
Macaron Powder  
super matt



ORIGINAL  
RESOPAL®

Page 1.27

**RESOPAL PRO  
XL 32016-32019**  
Brown Powder super  
matt



ORIGINAL  
RESOPAL®

Page 1.27

**RESOPAL PRO  
XL 32021-32024**  
Nature Powder super  
matt



ORIGINAL  
RESOPAL®

Page 1.28

**RESOPAL PRO EDGE  
XL 33000**  
Jura Grey super matt



ORIGINAL  
RESOPAL®

Page 1.29

**RESOPAL PRO EDGE  
XL 33005**  
black super matt



ORIGINAL  
RESOPAL®

Page 1.29

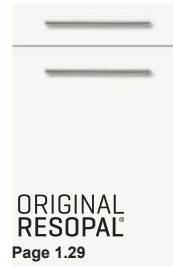
**RESOPAL PRO EDGE  
XL 33010**  
Anthracite super matt



ORIGINAL  
RESOPAL®

Page 1.29

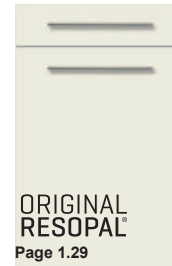
**RESOPAL PRO EDGE  
XL 33015**  
Titanium grey super  
matt



ORIGINAL  
RESOPAL®

Page 1.29

**RESOPAL PRO EDGE  
XL 33020**  
cool white super matt



ORIGINAL  
RESOPAL®

Page 1.29

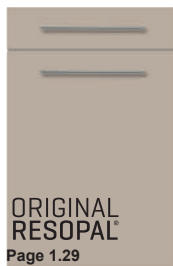
**RESOPAL PRO EDGE  
XL 33025**  
Premium white super  
matt



ORIGINAL  
RESOPAL®

Page 1.29

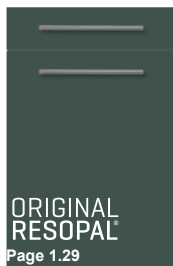
**RESOPAL PRO EDGE  
XL 33030**  
Light Powder super  
matt



ORIGINAL  
RESOPAL®

Page 1.29

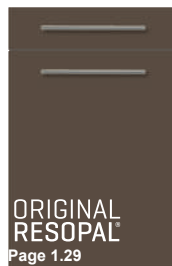
**RESOPAL PRO EDGE  
XL 33035**  
Dark Powder super  
matt



ORIGINAL  
RESOPAL®

Page 1.29

**RESOPAL PRO EDGE  
XL 33050**  
Moonlight Green  
super matt



ORIGINAL  
RESOPAL®

Page 1.29

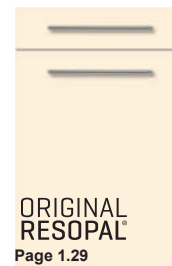
**RESOPAL PRO EDGE  
XL 33055**  
Brown Powder super  
matt



ORIGINAL  
RESOPAL®

Page 1.29

**RESOPAL PRO EDGE  
XL 33060**  
Nature Powder super  
matt



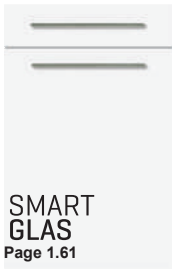
ORIGINAL  
RESOPAL®

Page 1.29

**RESOPAL PRO EDGE  
XL 33065**  
Macaron Powder  
super matt

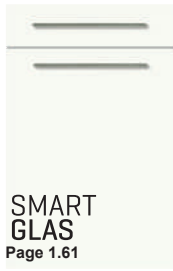
# Overview - Fronts

**PG 4**



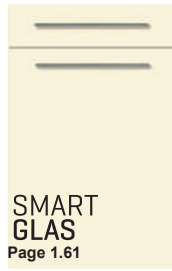
**SMART GLAS**  
Page 1.61

**SMART-M XL 4621**  
SMARTGLAS, satin-finish snow white



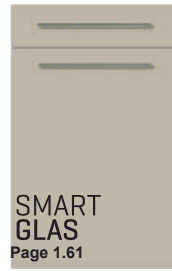
**SMART GLAS**  
Page 1.61

**SMART-M XL 4601**  
SMARTGLAS, satin-finish Carrara white



**SMART GLAS**  
Page 1.61

**SMART-M XL 4606**  
SMARTGLAS, satin-finish cream



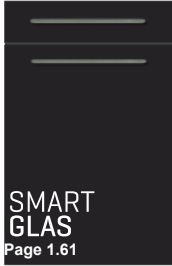
**SMART GLAS**  
Page 1.61

**SMART-M XL 4611**  
SMARTGLAS satin-finish sand grey



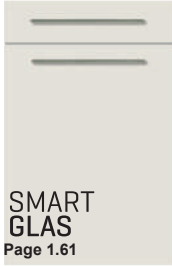
**SMART GLAS**  
Page 1.61

**SMART-M XL 4616**  
SMARTGLAS, satin-finish taupe



**SMART GLAS**  
Page 1.61

**SMART-M XL 4626**  
SMARTGLAS, satin-finish black



**SMART GLAS**  
Page 1.61

**SMART-M XL 4631**  
SMARTGLAS, satin-finish agate white



**SMART GLAS**  
Page 1.61

**SMART-M XL 4641**  
SMARTGLAS, satin-finish carbon metallic



**SMART GLAS**  
Page 1.61

**SMART-M XL 4666**  
SMARTGLAS, satin-finish, Aqua



**SMART GLAS**  
Page 1.61

**SMART-M XL 4671**  
SMARTGLAS satin-finish black metallic



**SMART GLAS**  
Page 1.61

**SMART-M XL 4676**  
SMARTGLAS satin-finish champagne metallic



**SMART GLAS**  
Page 1.61

**SMART-M XL 4681**  
SMARTGLAS satin-finish grey metallic



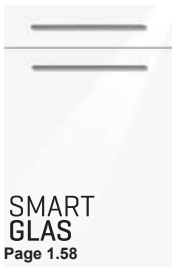
**SMART GLAS**  
Page 1.61

**SMART-M XL 4686**  
SMARTGLAS satin-finish silk metallic



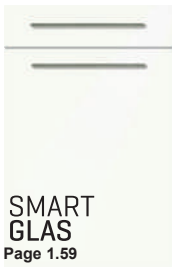
**SMART GLAS**  
Page 1.60

**SMART-M XL 4691**  
SMARTGLAS satin-finish bronze metallic



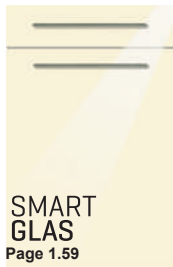
**SMART GLAS**  
Page 1.58

**SMART XL 4031**  
SMARTGLAS, high-gloss snow white



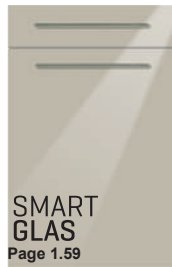
**SMART GLAS**  
Page 1.59

**SMART XL 4011**  
SMARTGLAS high-gloss Carrara white



**SMART GLAS**  
Page 1.59

**SMART XL 4016**  
SMARTGLAS high-gloss cream



**SMART GLAS**  
Page 1.59

**SMART XL 4021**  
SMARTGLAS high-gloss sand grey



**SMART GLAS**  
Page 1.59

**SMART XL 4036**  
SMARTGLAS, high-gloss black



**SMART GLAS**  
Page 1.59

**SMART XL 4041**  
SMARTGLAS, high-gloss white agate



Page 1.76

**PALAZZO XL 4370**  
Bronze Metallic



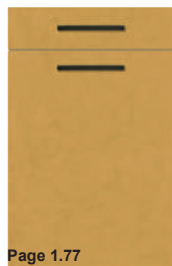
Page 1.77

**PALAZZO XL 4372**  
Basalt Metallic



Page 1.77

**PALAZZO XL 4374**  
Silver Metallic



Page 1.77

**PALAZZO XL 4376**  
Gold Metallic



Page 1.77

**PALAZZO XL 4378**  
Copper Metallic



Page 1.77

**PALAZZO XL 4380**  
Titan Metallic



# Overview - Fronts

PG 5



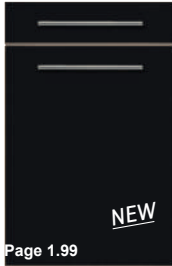
**FENIX**

Page 1.98

**FENIX INOX  
XL 5011**

metal facing stainless  
steel look super matt

PG 6



Page 1.99

**MULTIPLEX  
XL 6575**

black



Page 1.99

**MULTIPLEX  
XL 6580**

premium white

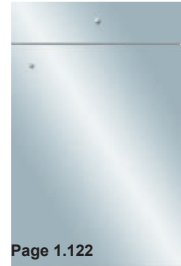


Page 1.99

**MULTIPLEX  
XL 6585**

Dark Powder

PG 6



Page 1.122

**SMART MIRROR  
XL 6860**

SMARTGLAS, mirror

PG 6



Page 1.112

**FLORENZ  
XL 6810**

walnut stained



Page 1.113

**MODENA  
XL 6815**

walnut stained



Page 1.114

**TIM  
XL 6100**

Dark oak stained,  
brushed

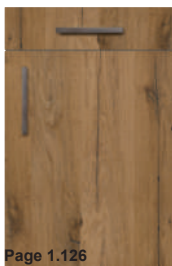


Page 1.115

**TIM 15  
XL 6700**

Dark oak stained,  
brushed

PG 7



Page 1.126

**MONTANA  
XL 7701**

mature oak wood  
vener vertical



Page 1.127

**MONTANA  
XL 7710**

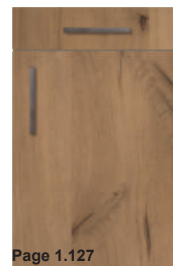
Spessart oak light



Page 1.127

**MONTANA  
XL 7750**

larch veneer vertical



Page 1.127

**MONTANA  
XL 7770**

Spessart oak leached  
vener vertical



Page 1.127

**MONTANA  
XL 7780**

Spessart oak Honey  
vener vertical

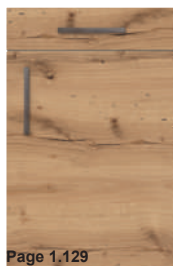
PG 7



Page 1.128

**NEVADA  
XL 7700**

mature oak veneer  
horizontal



Page 1.129

**NEVADA  
XL 7715**

Spessart oak light  
vener Horizontal



Page 1.129

**NEVADA  
XL 7755**

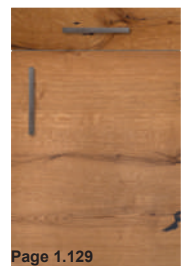
larch veneer horizontal



Page 1.129

**NEVADA  
XL 7775**

Spessart oak leached  
vener horizontal



Page 1.129

**NEVADA  
XL 7785**

Spessart oak honey  
vener horizontal

# Overview - Fronts

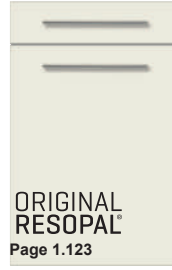
PG 7



Page 1.131  
**CASTELLO**  
**XL 7050**  
 premium white



**ORIGINAL**  
**RESOPAL**  
 Page 1.123  
**ALU TEC RP**  
**XL 7900**  
 black super matt



**ORIGINAL**  
**RESOPAL**  
 Page 1.123  
**ALU TEC RP**  
**XL 7905**  
 Premium white super matt



**ORIGINAL**  
**RESOPAL**  
 Page 1.123  
**ALU TEC RP**  
**XL 7910**  
 Dark Powder super matt

PG 7



Page 1.130  
**RUSTY OAK**  
**XL 7500**  
 Rusty Oak

PG 8



Page 1.134  
**INTARSIA**  
**XL 8200**  
 Gavi oak veneer

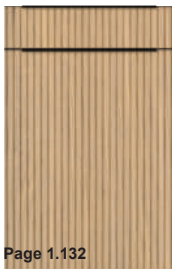


Page 1.134  
**INTARSIA**  
**XL 8205**  
 Rosso walnut veneer

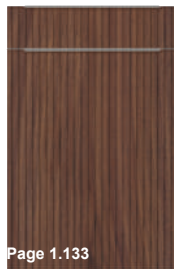


Page 1.134  
**INTARSIA**  
**XL 8210**  
 Dark oak stained

PG 8



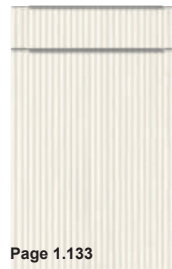
Page 1.132  
**TALEA**  
**XL 8060**  
 Gavi oak veneer



Page 1.133  
**TALEA**  
**XL 8065**  
 Rosso walnut veneer



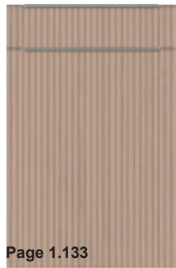
Page 1.133  
**TALEA**  
**XL 8070**  
 Dark oak stained



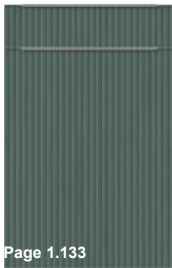
Page 1.133  
**TALEA**  
**XL 8120**  
 Premium white lacquered oak



Page 1.133  
**TALEA**  
**XL 8125**  
 black lacquered oak



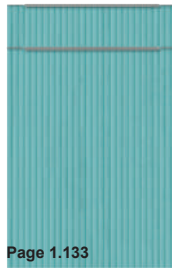
Page 1.133  
**TALEA**  
**XL 8126**  
 Eiche Light Nude lacquered



Page 1.133  
**TALEA**  
**XL 8129**  
 Oak Night Green lacquered



Page 1.133  
**TALEA**  
**XL 8140**  
 oak Art Pepper lacquered



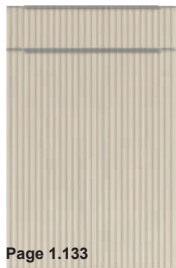
Page 1.133  
**TALEA**  
**XL 8149**  
 Special colour oak veneer



Page 1.133  
**TALEA**  
**XL 8165**  
 Macaron oak lacquered



Page 1.133  
**TALEA**  
**XL 8167**  
 Fango oak, lacquered



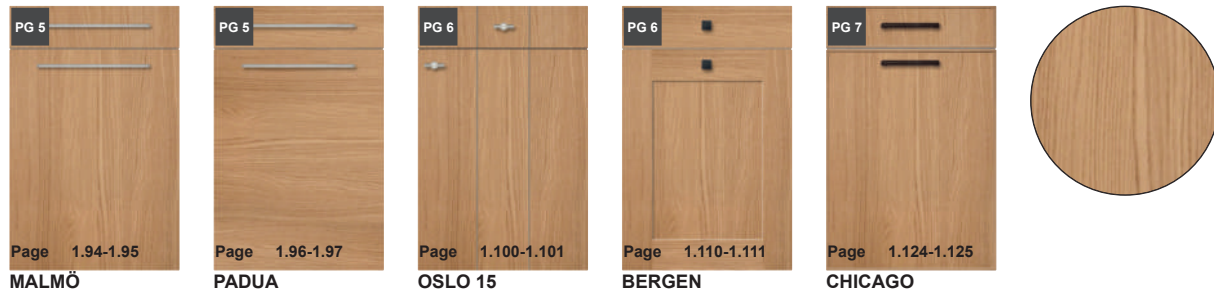
Page 1.133  
**TALEA**  
**XL 8169**  
 oak Light Pepper lacquered



Page 1.133  
**TALEA**  
**XL 8195**  
 graphite black oak lacquered

# All veneer fronts at a glance

## Overview veneer - oak veneer fronts



## Overview veneer - Bavaria oak veneer fronts



## All veneer colours at a glance



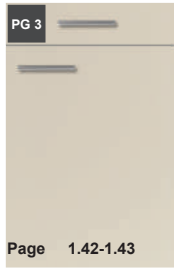
Special paint finishes according to RAL, SIKKENS or COLOR NETWORK:  
 Special finishes from the RALClassic, RAL-DESIGN, SIKKENS or COLOR NETWORK colour systems are available for an additional charge per order and colour.  
 The surcharge is calculated from the first article, irrespective of the order volume.  
 If several colours are required in one order, the surcharge must be taken into account for each colour.  
 Minor color deviations in subsequent deliveries cannot be ruled out.  
 Older sample charts will change when exposed to light.

### Special finish oak veneer



# All lacquer fronts at a glance Overview

## Overview - micro textured lacquer fronts



Page 1.42-1.43

ARTE-S



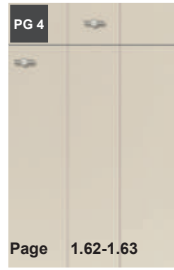
Page 1.50-1.51

ROMA-S



Page 1.46-1.47

PALERMO-S



Page 1.62-1.63

VILLAGE 15-S



Page 1.66-1.67

NOBEL-S



Page 1.70-1.71

SOFIE-S



Page 1.82-1.83

YORK-S



Page 1.86-1.87

CHALET-S



Page 1.78-1.79

ATLANTA-S



Page 1.118-1.119

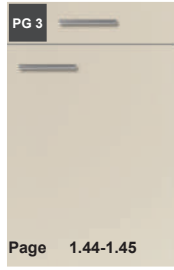
ORLANDO-S

## Overview - velvet lacquer fronts



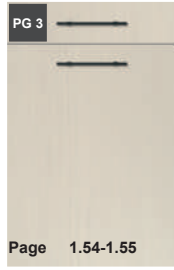
Page 1.48-1.49

PALERMO-B



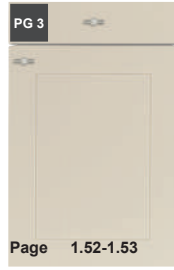
Page 1.44-1.45

ARTE-B



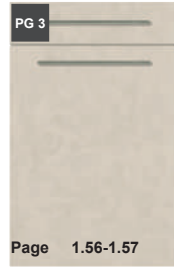
Page 1.54-1.55

SIGNUM-B



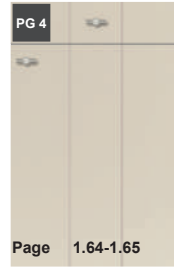
Page 1.52-1.53

ROMA-B



Page 1.56-1.57

CASA-B



Page 1.64-1.65

VILLAGE 15-B



Page 1.68-1.69

NOBEL-B



Page 1.74-1.75

LUX-B



Page 1.72-1.73

SOFIE-B



Page 1.84-1.85

YORK-B



Page 1.88-1.89

CHALET-B



Page 1.80-1.81

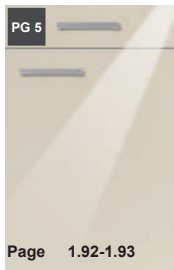
ATLANTA-B



Page 1.120-1.121

ORLANDO-B

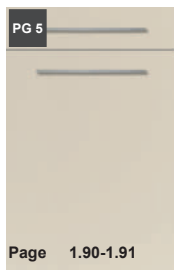
## Overview - high-gloss lacquer fronts



Page 1.92-1.93

OPAL-H

## Overview - Premium matt lacquer fronts



Page 1.90-1.91

NEW OPAL-M

## Overview - Soft lacquer fronts



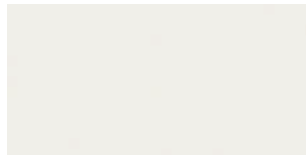
Page 1.116-1.117

VINO

# All lacquer colours at a glance



Light Grey



Premium white



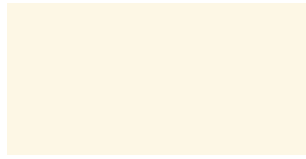
Graphite Black



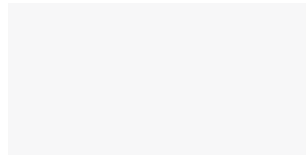
Magic-grey



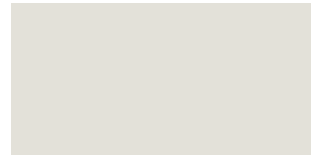
Black



Macaron



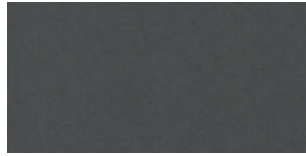
Snow White



White Agate



Light Pepper



Art Pepper



Night Green



Light Nude



Fango



Special colours

Special paint finishes according to RAL, SIKKENS or COLOR NETWORK:

Special finishes from the RALClassic, RAL-DESIGN, SIKKENS or COLOR NETWORK colour systems are available for an additional charge per order and colour.

The surcharge is calculated from the first article, irrespective of the order volume.

If several colours are required in one order, the surcharge must be taken into account for each colour.

Minor color deviations in subsequent deliveries cannot be ruled out.

Older sample charts will change when exposed to light.

## Colour concept at no extra charge



Sealbrown  
RAL 8019



cristal red  
SIKKENS  
C0.60.30



Savona green  
SIKKENS  
K0.05.47



Victoria green  
RAL 180 30 10



Night Red  
SIKKENS  
C0.20.20



Blackblue  
SIKKENS  
U0.10.20

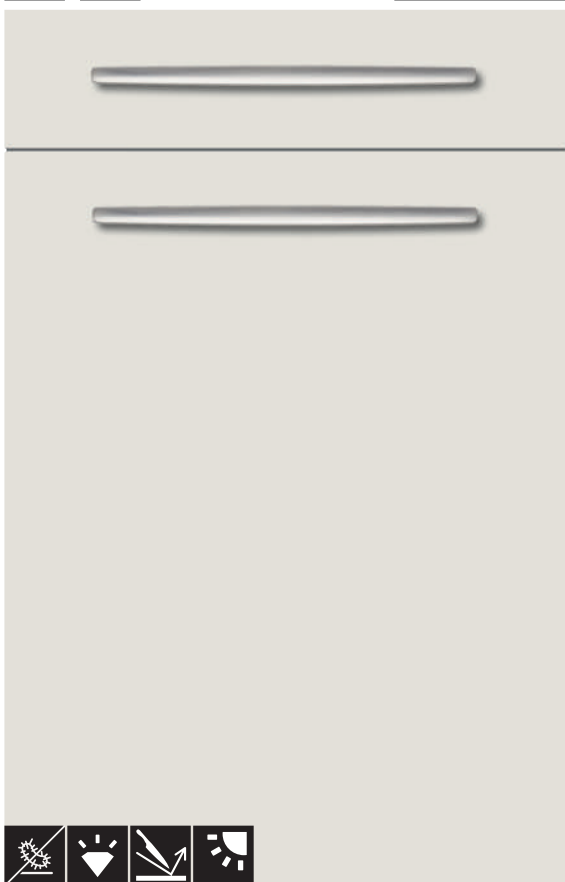


Jade, pastel  
RAL 7032



live simple!  
No. 8

**XL** **GL** << 31-119 cm >>

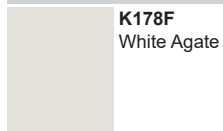


**Front decor** white agate matt  
(rear in same colour)  
**Surface** Smooth  
**Front thickness** 19 mm  
**Door shape** 12,403 kg/sqm excluding handle weight (see handles)  
straight, 4 sides with contoured PP edge,  
1.3 mm PUR edge gluing  
**Front material** multi-layer particle board, coated with melamine resin

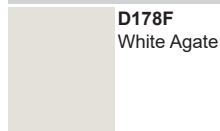
**Available glass doors for specific models**



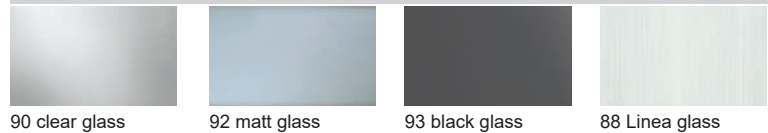
**Reference carcass**



**Visible sides**



**Available glass versions**



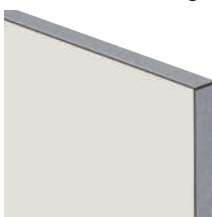
**Contoured PP edge**

same decor



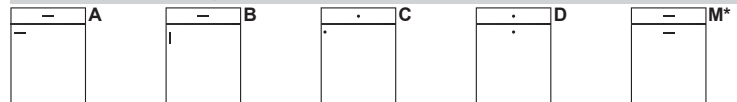
XL 1421

stainless steel facing



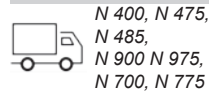
XL 1424

**Available handle arrangements**



\* = Standard finish





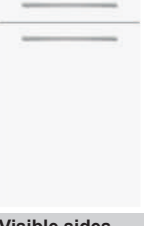

**Grip ledges**



**Handles**

**cornices / light pelmets**

Dual

<p><b>Front decor</b> premium white</p> <p><b>Surface</b> minipearl texture</p>  <table border="1"> <tr><td><b>Contoured PP edge</b></td><td></td></tr> <tr><td>same decor</td><td>XL 1011</td></tr> <tr><td>Dual</td><td>XL 1012</td></tr> <tr><td>stainless steel facing</td><td>XL 1014</td></tr> </table> <p><b>Reference carcass</b> K039P Premium white</p> <p><b>Visible sides</b> K039P Premium white</p>	<b>Contoured PP edge</b>		same decor	XL 1011	Dual	XL 1012	stainless steel facing	XL 1014	<p><b>Front decor</b> light grey</p> <p><b>Surface</b> minipearl texture</p>  <table border="1"> <tr><td><b>Contoured PP edge</b></td><td></td></tr> <tr><td>same decor</td><td>XL 1026</td></tr> <tr><td>Dual</td><td></td></tr> <tr><td>stainless steel facing</td><td>XL 1029</td></tr> </table> <p><b>Reference carcass</b> K006P Light Grey</p> <p><b>Visible sides</b> K006P Light Grey</p>	<b>Contoured PP edge</b>		same decor	XL 1026	Dual		stainless steel facing	XL 1029	<p><b>Front decor</b> magic grey</p> <p><b>Surface</b> minipearl texture</p>  <table border="1"> <tr><td><b>Contoured PP edge</b></td><td></td></tr> <tr><td>same decor</td><td>XL 1051</td></tr> <tr><td>Dual</td><td></td></tr> <tr><td>stainless steel facing</td><td>XL 1054</td></tr> </table> <p><b>Reference carcass</b> K058P Magic-grey</p> <p><b>Visible sides</b> K058P Magic-grey</p>	<b>Contoured PP edge</b>		same decor	XL 1051	Dual		stainless steel facing	XL 1054
<b>Contoured PP edge</b>																										
same decor	XL 1011																									
Dual	XL 1012																									
stainless steel facing	XL 1014																									
<b>Contoured PP edge</b>																										
same decor	XL 1026																									
Dual																										
stainless steel facing	XL 1029																									
<b>Contoured PP edge</b>																										
same decor	XL 1051																									
Dual																										
stainless steel facing	XL 1054																									
<p><b>Front decor</b> graphite black</p> <p><b>Surface</b> Soft Pearl</p>  <table border="1"> <tr><td><b>Contoured PP edge</b></td><td></td></tr> <tr><td>same decor</td><td>XL 1056</td></tr> <tr><td>Dual</td><td></td></tr> <tr><td>stainless steel facing</td><td>XL 1059</td></tr> </table> <p><b>Reference carcass</b> K043P Graphite Black</p> <p><b>Visible sides</b> K043P Graphite Black</p>	<b>Contoured PP edge</b>		same decor	XL 1056	Dual		stainless steel facing	XL 1059	<p><b>Front decor</b> Macaron</p> <p><b>Surface</b> Soft Pearl</p>  <table border="1"> <tr><td><b>Contoured PP edge</b></td><td></td></tr> <tr><td>same decor</td><td>XL 1116</td></tr> <tr><td>Dual</td><td>XL 1117</td></tr> <tr><td>stainless steel facing</td><td>XL 1119</td></tr> </table> <p><b>Reference carcass</b> K076P Macaron</p> <p><b>Visible sides</b> K076P Macaron</p>	<b>Contoured PP edge</b>		same decor	XL 1116	Dual	XL 1117	stainless steel facing	XL 1119	<p><b>Front decor</b> stainless steel-coloured (vertical grain pattern)</p> <p><b>Surface</b> Soft Pearl</p>  <table border="1"> <tr><td><b>Contoured PP edge</b></td><td></td></tr> <tr><td>same decor</td><td>XL 1181</td></tr> <tr><td>Dual</td><td></td></tr> <tr><td>stainless steel facing</td><td>XL 1184</td></tr> </table> <p><b>Reference carcass</b> K023P Stainless Steel Colour</p> <p><b>Visible sides</b> K023P Stainless Steel Colour</p>	<b>Contoured PP edge</b>		same decor	XL 1181	Dual		stainless steel facing	XL 1184
<b>Contoured PP edge</b>																										
same decor	XL 1056																									
Dual																										
stainless steel facing	XL 1059																									
<b>Contoured PP edge</b>																										
same decor	XL 1116																									
Dual	XL 1117																									
stainless steel facing	XL 1119																									
<b>Contoured PP edge</b>																										
same decor	XL 1181																									
Dual																										
stainless steel facing	XL 1184																									
<p><b>Front decor</b> premium white matt</p> <p><b>Surface</b> Smooth</p>  <table border="1"> <tr><td><b>Contoured PP edge</b></td><td></td></tr> <tr><td>same decor</td><td>XL 1301</td></tr> <tr><td>Dual</td><td>XL 1302</td></tr> <tr><td>stainless steel facing</td><td>XL 1304</td></tr> </table> <p><b>Reference carcass</b> K039P Premium white</p> <p><b>Visible sides</b> D039F Premium white matt</p>	<b>Contoured PP edge</b>		same decor	XL 1301	Dual	XL 1302	stainless steel facing	XL 1304	<p><b>Front decor</b> snow white matt</p> <p><b>Surface</b> Smooth</p>  <table border="1"> <tr><td><b>Contoured PP edge</b></td><td></td></tr> <tr><td>same decor</td><td>XL 1351</td></tr> <tr><td>Dual</td><td>XL 1352</td></tr> <tr><td>stainless steel facing</td><td>XL 1354</td></tr> </table> <p><b>Reference carcass</b> K160F Snow white</p> <p><b>Visible sides</b> D160F Snow white matt</p>	<b>Contoured PP edge</b>		same decor	XL 1351	Dual	XL 1352	stainless steel facing	XL 1354	<p><b>Front decor</b> black</p> <p><b>Surface</b> Soft Pearl</p>  <table border="1"> <tr><td><b>Contoured PP edge</b></td><td></td></tr> <tr><td>same decor</td><td>XL 1486</td></tr> <tr><td>Dual</td><td></td></tr> <tr><td>stainless steel facing</td><td>XL 1489</td></tr> </table> <p><b>Reference carcass</b> K075P Black</p> <p><b>Visible sides</b> K075P Black</p>	<b>Contoured PP edge</b>		same decor	XL 1486	Dual		stainless steel facing	XL 1489
<b>Contoured PP edge</b>																										
same decor	XL 1301																									
Dual	XL 1302																									
stainless steel facing	XL 1304																									
<b>Contoured PP edge</b>																										
same decor	XL 1351																									
Dual	XL 1352																									
stainless steel facing	XL 1354																									
<b>Contoured PP edge</b>																										
same decor	XL 1486																									
Dual																										
stainless steel facing	XL 1489																									
<p><b>Front decor</b> Light Pepper</p> <p><b>Surface</b> Soft Pearl</p>  <table border="1"> <tr><td><b>Contoured PP edge</b></td><td></td></tr> <tr><td>same decor</td><td>XL 1586</td></tr> <tr><td>Dual</td><td></td></tr> <tr><td>stainless steel facing</td><td>XL 1589</td></tr> </table> <p><b>Reference carcass</b> K218P Light Pepper</p> <p><b>Visible sides</b> K218P Light Pepper</p>	<b>Contoured PP edge</b>		same decor	XL 1586	Dual		stainless steel facing	XL 1589	<p><b>Front decor</b> Art Pepper</p> <p><b>Surface</b> Soft Pearl</p>  <table border="1"> <tr><td><b>Contoured PP edge</b></td><td></td></tr> <tr><td>same decor</td><td>XL 1621</td></tr> <tr><td>Dual</td><td></td></tr> <tr><td>stainless steel facing</td><td>XL 1624</td></tr> </table> <p><b>Reference carcass</b> K230P Art Pepper</p> <p><b>Visible sides</b> K230P Art Pepper</p>	<b>Contoured PP edge</b>		same decor	XL 1621	Dual		stainless steel facing	XL 1624	<p><b>Front decor</b> Light Nude</p> <p><b>Surface</b> Soft Pearl</p>  <table border="1"> <tr><td><b>Contoured PP edge</b></td><td></td></tr> <tr><td>same decor</td><td>XL 1661</td></tr> <tr><td>Dual</td><td></td></tr> <tr><td>stainless steel facing</td><td>XL 1664</td></tr> </table> <p><b>Reference carcass</b> K248P Light Nude</p> <p><b>Visible sides</b> K248P Light Nude</p>	<b>Contoured PP edge</b>		same decor	XL 1661	Dual		stainless steel facing	XL 1664
<b>Contoured PP edge</b>																										
same decor	XL 1586																									
Dual																										
stainless steel facing	XL 1589																									
<b>Contoured PP edge</b>																										
same decor	XL 1621																									
Dual																										
stainless steel facing	XL 1624																									
<b>Contoured PP edge</b>																										
same decor	XL 1661																									
Dual																										
stainless steel facing	XL 1664																									
<p><b>Front decor</b> Fango</p> <p><b>Surface</b> minipearl texture</p>  <table border="1"> <tr><td><b>Contoured PP edge</b></td><td></td></tr> <tr><td>same decor</td><td>XL 1721</td></tr> <tr><td>Dual</td><td></td></tr> <tr><td>stainless steel facing</td><td>XL 1724</td></tr> </table> <p><b>Reference carcass</b> K263P Fango</p> <p><b>Visible sides</b> K263P Fango</p>	<b>Contoured PP edge</b>		same decor	XL 1721	Dual		stainless steel facing	XL 1724	<p><b>Front decor</b> Jade, pastel</p> <p><b>Surface</b> Smooth</p>  <table border="1"> <tr><td><b>Contoured PP edge</b></td><td></td></tr> <tr><td>same decor</td><td>XL 1771</td></tr> <tr><td>Dual</td><td></td></tr> <tr><td>stainless steel facing</td><td>XL 1774</td></tr> </table> <p><b>Reference carcass</b> K218P Light Pepper</p> <p><b>Visible sides</b> D272F Jade, pastel</p>	<b>Contoured PP edge</b>		same decor	XL 1771	Dual		stainless steel facing	XL 1774									
<b>Contoured PP edge</b>																										
same decor	XL 1721																									
Dual																										
stainless steel facing	XL 1724																									
<b>Contoured PP edge</b>																										
same decor	XL 1771																									
Dual																										
stainless steel facing	XL 1774																									



**XL** **GL** << 31-119 cm >>



**Front decor** Natural sandstone effect  
(rear in same colour)

**Surface** Smooth

**Front thickness** 19 mm

**Door shape** 12,403 kg/sqm excluding handle weight (see handles)  
straight, 4 sides with contoured PP edge,  
1.3 mm PUR edge gluing

**Front material** multi-layer particle board, coated with melamine resin

**NEW**

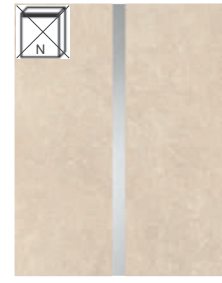
**Available glass doors for specific models**



**Segment glass door**  
e.g. HG 50 78 34 SE

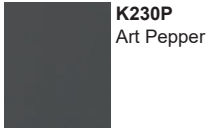


**Semi-frameless glass door...**  
e.g. HG 50 78 34 LS



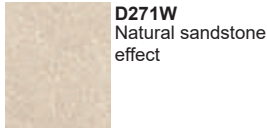
**Semi-frameless glass door / glass width 5 cm...**  
e.g. HG 50 78 34 LB

**Reference carcass**



**K230P**  
Art Pepper

**Visible sides**

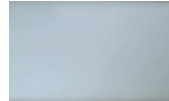


**D271W**  
Natural sandstone effect

**Available glass versions**



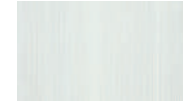
90 clear glass



92 matt glass



93 black glass



88 Linea glass

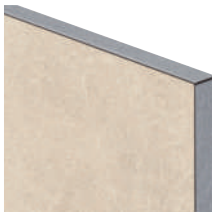
**Contoured PP edge**

same decor



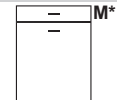
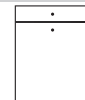
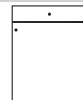
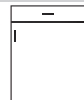
XL 1761

stainless steel facing



XL 1764

**Available handle arrangements**



\* = Standard finish

**Grip ledges**




N 400, N 475,  
N 485,  
N 900 N 975,  
N 700, N 775


**Handles**

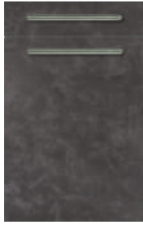
**cornices / light pelmets**


Dual




<b>Front decor</b>	opal concrete effect
<b>Surface</b>	concrete texture
	<b>Contoured PP edge</b>
	same decor <b>XL 1466</b>
	Dual
	stainless steel facing <b>XL 1469</b>
<b>Reference carcass</b>	
K178F White Agate	
<b>Visible sides</b>	
D187W Concrete effect opal	

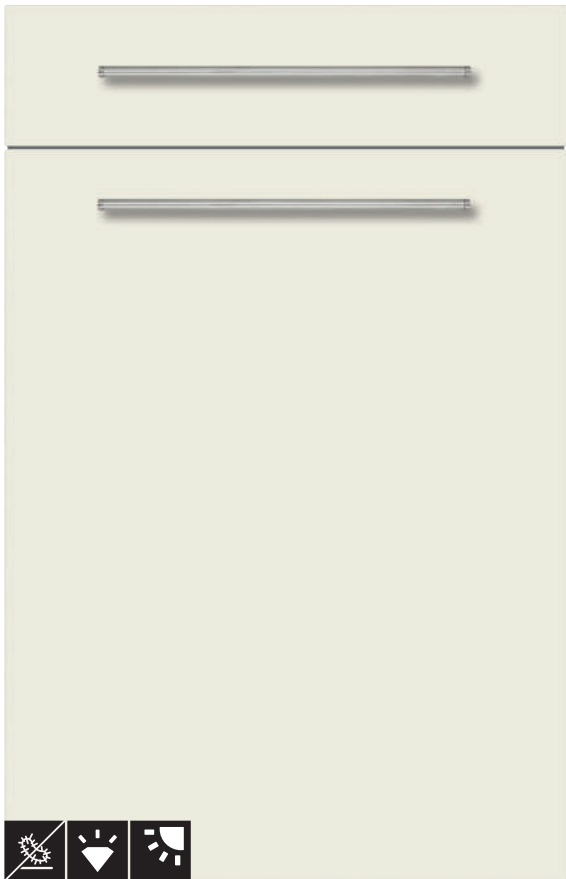
<b>Front decor</b>	pearl grey concrete effect
<b>Surface</b>	concrete texture
	<b>Contoured PP edge</b>
	same decor <b>XL 1471</b>
	Dual
	stainless steel facing <b>XL 1474</b>
<b>Reference carcass</b>	
K043P Graphite Black	
<b>Visible sides</b>	
D188W Concrete effect pearl grey	

<b>Front decor</b>	graphite concrete effect
<b>Surface</b>	concrete texture
	<b>Contoured PP edge</b>
	same decor <b>XL 1506</b>
	Dual
	stainless steel facing <b>XL 1509</b>
<b>Reference carcass</b>	
K043P Graphite Black	
<b>Visible sides</b>	
D212W graphite concrete effect	

<b>Front decor</b>	brown concrete effect
<b>Surface</b>	concrete texture
	<b>Contoured PP edge</b>
	same decor <b>XL 1616</b>
	Dual
	stainless steel facing <b>XL 1619</b>
<b>Reference carcass</b>	
K075P Black	
<b>Visible sides</b>	
D149W brown concrete effect	

<b>Front decor</b>	Titan Steel
<b>Surface</b>	Smooth
	<b>Contoured PP edge</b>
	same decor <b>XL 1626</b>
	Dual
	stainless steel facing <b>XL 1629</b>
<b>Reference carcass</b>	
K235P Titan Steel	
<b>Visible sides</b>	
K235P Titan Steel	

**XL** **GL** << 31-119 cm >>



**Front decor** gloss premium white (rear in same colour)  
**Surface** smooth (gloss)  
**Front thickness** 19 mm  
**Door shape** 12,403 kg/sqm excluding handle weight (see handles)  
 straight, 4 sides with contoured PP edge,  
 1.3 mm PUR edge gluing  
**Front material** MDF substrate, coated with melamine resin

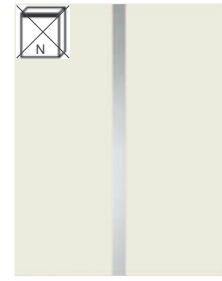
**Available glass doors for specific models**



**Segment glass door**  
 e.g. HG 50 78 34 SE

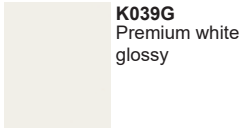


**Semi-frameless glass door...**  
 e.g. HG 50 78 34 LS



**Semi-frameless glass door / glass width 5 cm...**  
 e.g. HG 50 78 34 LB

**Reference carcass**



**K039G**  
 Premium white glossy

**Visible sides**

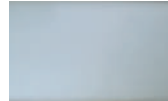


**K039G**  
 Premium white glossy

**Available glass versions**



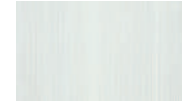
90 clear glass



92 matt glass



93 black glass



88 Linea glass

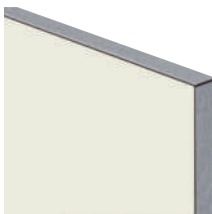
**Contoured PP edge**

same decor



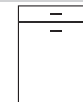
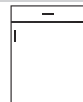
XL 1251

stainless steel facing



XL 1254

**Available handle arrangements**



\* = Standard finish

**Grip ledges**

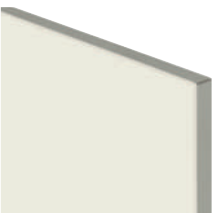


N 400, N 475,  
 N 485,  
 N 900 N 975,  
 N 700, N 775

**Handles**

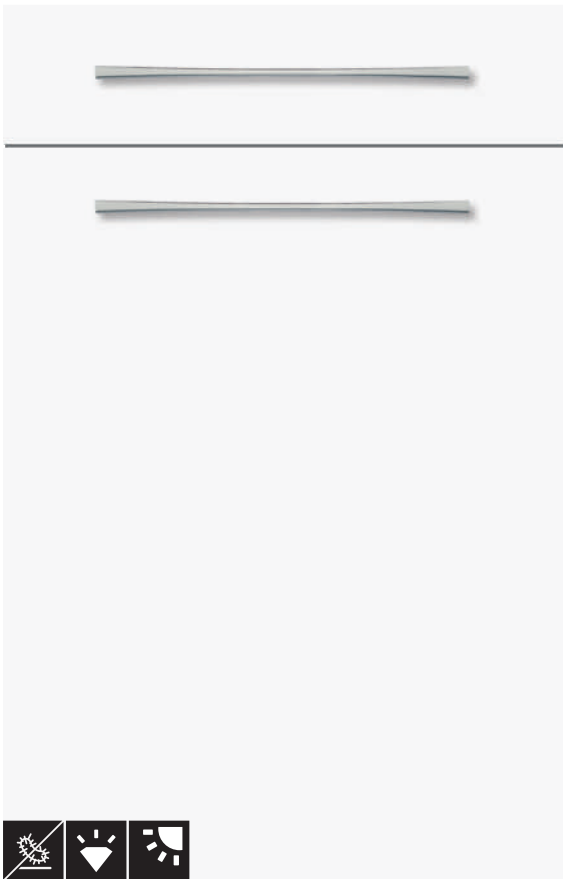
**cornices / light pelmets**

Dual



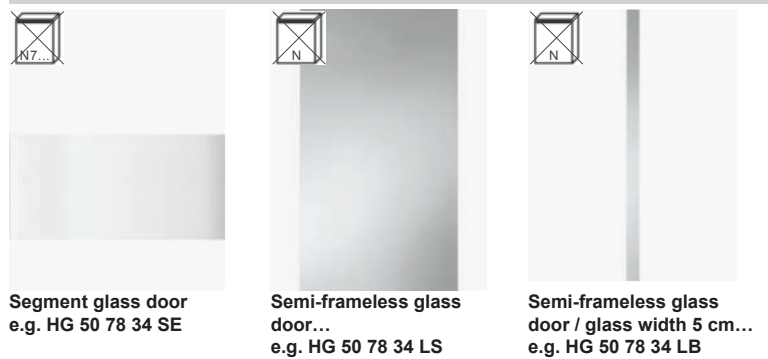
XL 1252

**XL** **GL** << 31-119 cm >>



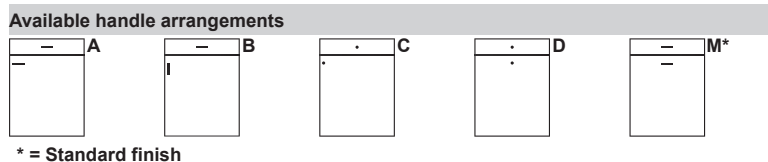
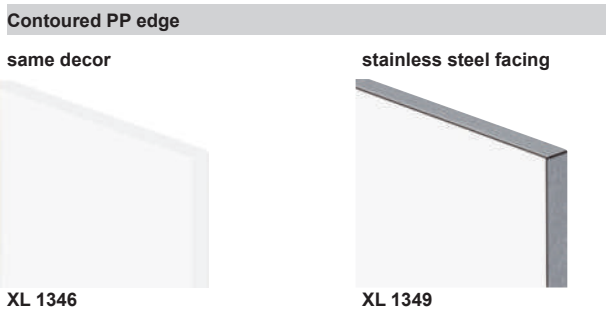
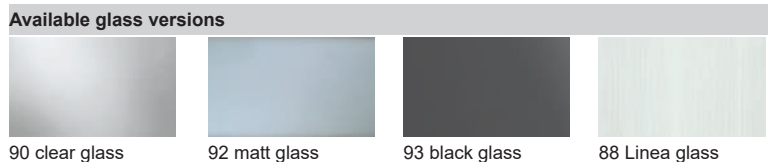
**Front decor** Snow White Gloss  
(rear gloss snow white)  
**Surface** smooth (gloss)  
**Front thickness** 19 mm  
12,403 kg/sqm excluding handle weight (see handles)  
**Door shape** straight, 4 sides with contoured PP edge,  
1.3 mm PUR edge gluing  
**Front material** MDF substrate, coated with melamine resin

**Available glass doors for specific models**



**Reference carcass**  
**K160G**  
Snow White Gloss

**Visible sides**  
**K160G**  
Snow White Gloss



**Grip ledges** **Handles** **cornices / light pelmets**

N 400, N 475,  
N 485,  
N 700, N 775  
N 900 N 975,

**XL** **GL** << 31-119 cm >>

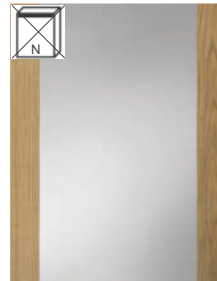


**Front decor** Classic Oak effect  
(rear in same colour)  
**Surface** Synchronised grain structure  
**Front thickness** 19 mm  
**Door shape** 12,403 kg/sqm excluding handle weight (see handles)  
straight, 4 sides with contoured PP edge,  
1.3 mm PUR edge gluing  
**Front material** multi-layer particle board, coated with melamine resin

**Available glass doors for specific models**



**Segment glass door**  
e.g. HG 50 78 34 SE

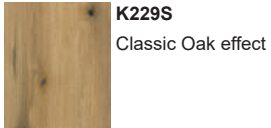


**Semi-frameless glass door...**  
e.g. HG 50 78 34 LS

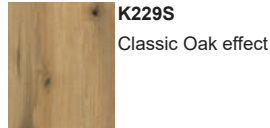


**Semi-frameless glass door / glass width 5 cm...**  
e.g. HG 50 78 34 LB

**Reference carcass**



**Visible sides**



**Available glass versions**



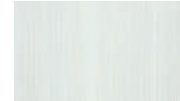
90 clear glass



92 matt glass



93 black glass



88 Linea glass

**Contoured PP edge**

same decor



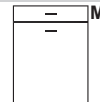
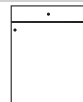
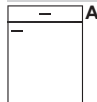
XL 1606

stainless steel facing



XL 1609

**Available handle arrangements**



\* = Standard finish

**Grip ledges**



N 400, N 475,  
N 485,  
N 700, N 775  
N 900 N 975,


**Handles**

**cornices / light pelmets**

Dual

**Front decor** Castell oak effect

**Surface** wood texture



<b>Contoured PP edge</b>	
same decor	XL 1211
Dual	
stainless steel facing	XL 1214

**Reference carcass**


**K005S**  
Castell Oak Effect

**Visible sides**

**K005S**  
Castell Oak Effect

**Front decor** natural mammoth oak effect

**Surface** wood texture



<b>Contoured PP edge</b>	
same decor	XL 1481
Dual	
stainless steel facing	XL 1484

**Reference carcass**


**K190S**  
Mammoth oak repro. natural

**Visible sides**

**K190S**  
Mammoth oak repro. natural

**Front decor** Piemont oak effect

**Surface** Deepskin



<b>Contoured PP edge</b>	
same decor	XL 1496
Dual	
stainless steel facing	XL 1499

**Reference carcass**


**K199S**  
Piemont Oak Repro

**Visible sides**

**K199S**  
Piemont Oak Repro

**Front decor** natural mountain oak effect

**Surface** Synchronised grain structure



<b>Contoured PP edge</b>	
same decor	XL 1556
Dual	
stainless steel facing	XL 1559

**Reference carcass**


**K216S**  
natural mountain oak effect

**Visible sides**

**K216S**  
natural mountain oak effect

**Front decor** Diamond Oak effect

**Surface** wood texture



<b>Contoured PP edge</b>	
same decor	XL 1641
Dual	
stainless steel facing	XL 1644

**Reference carcass**


**K236S**  
Diamond oak effect

**Visible sides**

**K236S**  
Diamond oak effect

**Front decor** Dark Maron effect

**Surface** wood texture



<b>Contoured PP edge</b>	
same decor	XL 1651
Dual	
stainless steel facing	XL 1654

**Reference carcass**


**K247S**  
Dark Maron effect

**Visible sides**

**K247S**  
Dark Maron effect

**Front decor** Black Oak effect

**Surface** wood texture



<b>Contoured PP edge</b>	
same decor	XL 1671
Dual	
stainless steel facing	XL 1674

**Reference carcass**


**K075P**  
Black

**Visible sides**

**D250S**  
Black Oak effect

**Front decor** Seal Oak effect

**Surface** Wood texture/synchronised grain structure



<b>Contoured PP edge</b>	
same decor	XL 1681
Dual	
stainless steel facing	XL 1684

**Reference carcass**

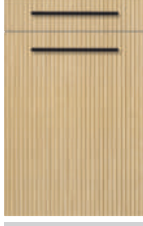
**K235P**  
Titan Steel

**Visible sides**

**D251S**  
Seal Oak effect

**Front decor** Light oak, grooved look

**Surface** wood texture with grooved look



<b>Contoured PP edge</b>	
same decor	XL 1691
Dual	
stainless steel facing	XL 1694

**Reference carcass**


**K230P**  
Art Pepper

**Visible sides**

**D264S**  
Light oak, grooved look

**Front decor** Dark oak, grooved look

**Surface** wood texture with grooved look



<b>Contoured PP edge</b>	
same decor	XL 1701
Dual	
stainless steel facing	XL 1704

**Reference carcass**


**K043P**  
Graphite Black

**Visible sides**

**D265S**  
Dark oak, grooved look

**Front decor** Royal Oak effect

**Surface** Synchronised grain structure



<b>Contoured PP edge</b>	
same decor	XL 1711
Dual	
stainless steel facing	XL 1714

**Reference carcass**


**K262S**  
Royal Oak effect

**Visible sides**

**K262S**  
Royal Oak effect

**Front decor** Mountain Wood

**Surface** wood texture



<b>Contoured PP edge</b>	
same decor	XL 1731
Dual	
stainless steel facing	XL 1734

**Reference carcass**


**K269S**  
Mountain Wood

**Visible sides**

**K269S**  
Mountain Wood

**Front decor** Elegant walnut effect

**Surface** wood texture



<b>Contoured PP edge</b>	
same decor	XL 1741
Dual	
stainless steel facing	XL 1744

**Reference carcass**

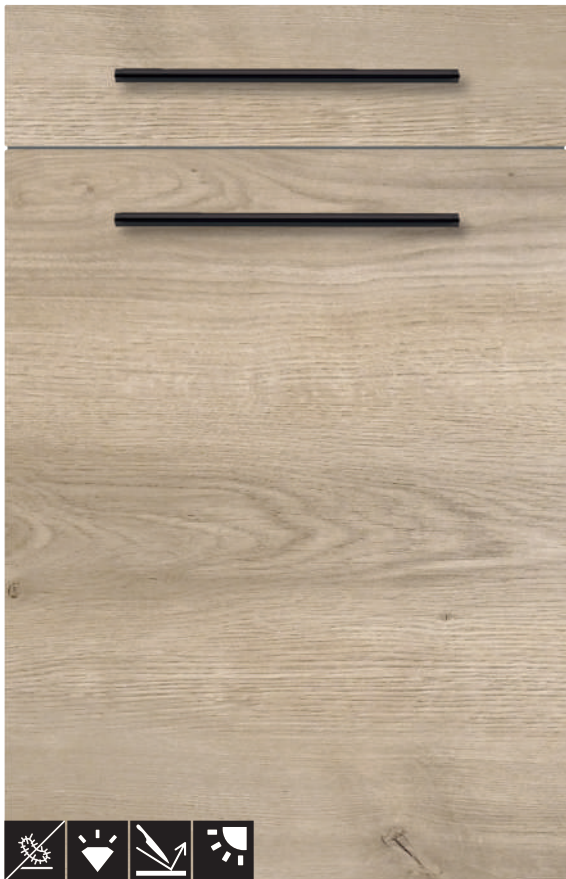
**K270S**  
Elegant walnut effect

**Visible sides**

**K270S**  
Elegant walnut effect



**XL** **GL** << 31-119 cm >>



**Front decor** Diamond Oak effect  
(rear in same colour)  
**Surface** wood texture  
**Front thickness** 19 mm  
**Door shape** 12,403 kg/sqm excluding handle weight (see handles)  
straight, 4 sides with contoured PP edge,  
1.3 mm PUR edge gluing  
**Front material** multi-layer particle board, coated with melamine resin

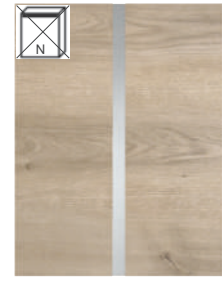
Available glass doors for specific models



Segment glass door  
e.g. HG 50 78 34 SE

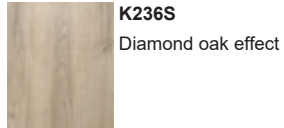


Semi-frameless glass  
door...  
e.g. HG 50 78 34 LS

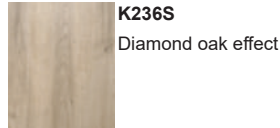


Semi-frameless glass  
door / glass width 5 cm...  
e.g. HG 50 78 34 LB

Reference carcass



Visible sides



Available glass versions



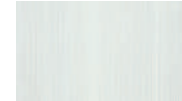
90 clear glass



92 matt glass



93 black glass



88 Linea glass

Contoured PP edge

same decor



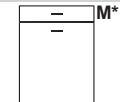
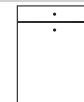
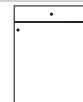
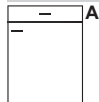
XL 1646

stainless steel facing



XL 1649

Available handle arrangements



\* = Standard finish

Grip ledges



N 400, N 475,  
N 485,  
N 700, N 775  
N 900 N 975,


Handles

cornices / light pelmets

Dual

**Front decor** Piemont oak effect

**Surface** Deepskin




<b>Contoured PP edge</b>	
same decor	XL 1501
Dual	
stainless steel facing	XL 1504
<b>Reference carcass</b>	
<b>K199S</b>	Piemont Oak Repro

**Visible sides**  
**K199S**  
Piemont Oak Repro

**Front decor** Castell oak effect

**Surface** wood texture




<b>Contoured PP edge</b>	
same decor	XL 1521
Dual	
stainless steel facing	XL 1524
<b>Reference carcass</b>	
<b>K005S</b>	Castell Oak Effect

**Visible sides**  
**K005S**  
Castell Oak Effect

**Front decor** mammoth oak effect

**Surface** wood texture

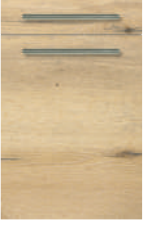


<b>Contoured PP edge</b>	
same decor	XL 1526
Dual	
stainless steel facing	XL 1529
<b>Reference carcass</b>	
<b>K190S</b>	Mammoth oak repro. natural

**Visible sides**  
**K190S**  
Mammoth oak repro. natural

**Front decor** natural mountain oak effect

**Surface** Synchronised grain structure




<b>Contoured PP edge</b>	
same decor	XL 1561
Dual	
stainless steel facing	XL 1564
<b>Reference carcass</b>	
<b>K216S</b>	natural mountain oak effect

**Visible sides**  
**K216S**  
natural mountain oak effect

**Front decor** Classic Oak effect

**Surface** Synchronised grain structure

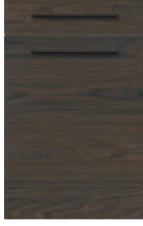


<b>Contoured PP edge</b>	
same decor	XL 1611
Dual	
stainless steel facing	XL 1614
<b>Reference carcass</b>	
<b>K229S</b>	Classic Oak effect

**Visible sides**  
**K229S**  
Classic Oak effect

**Front decor** Dark Maron effect

**Surface** wood texture




<b>Contoured PP edge</b>	
same decor	XL 1656
Dual	
stainless steel facing	XL 1659
<b>Reference carcass</b>	
<b>K247S</b>	Dark Maron effect

**Visible sides**  
**K247S**  
Dark Maron effect

**Front decor** Black Oak effect

**Surface** wood texture




<b>Contoured PP edge</b>	
same decor	XL 1676
Dual	
stainless steel facing	XL 1679
<b>Reference carcass</b>	
<b>K075P</b>	Black

**Visible sides**  
**D250S**  
Black Oak effect

**Front decor** Seal Oak effect

**Surface** Wood texture/synchronised grain structure




<b>Contoured PP edge</b>	
same decor	XL 1686
Dual	
stainless steel facing	XL 1689
<b>Reference carcass</b>	
<b>K235P</b>	Titan Steel

**Visible sides**  
**D251S**  
Seal Oak effect

**Front decor** Light oak, grooved look

**Surface** wood texture with grooved look




<b>Contoured PP edge</b>	
same decor	XL 1696
Dual	
stainless steel facing	XL 1699
<b>Reference carcass</b>	
<b>K230P</b>	Art Pepper

**Visible sides**  
**D264S**  
Light oak, grooved look

**Front decor** Dark oak, grooved look

**Surface** wood texture with grooved look




<b>Contoured PP edge</b>	
same decor	XL 1706
Dual	
stainless steel facing	XL 1709
<b>Reference carcass</b>	
<b>K043P</b>	Graphite Black

**Visible sides**  
**D265S**  
dark oak

**Front decor** Royal Oak effect

**Surface** Synchronised grain structure

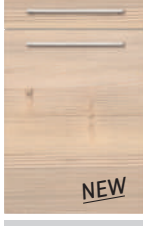


<b>Contoured PP edge</b>	
same decor	XL 1716
Dual	
stainless steel facing	XL 1719
<b>Reference carcass</b>	
<b>K262S</b>	Royal Oak effect

**Visible sides**  
**K262S**  
Royal Oak effect

**Front decor** Mountain Wood

**Surface** wood texture




<b>Contoured PP edge</b>	
same decor	XL 1736
Dual	
stainless steel facing	XL 1739
<b>Reference carcass</b>	
<b>K269S</b>	Mountain Wood

**Visible sides**  
**K269S**  
Mountain Wood

**Front decor** Elegant walnut effect

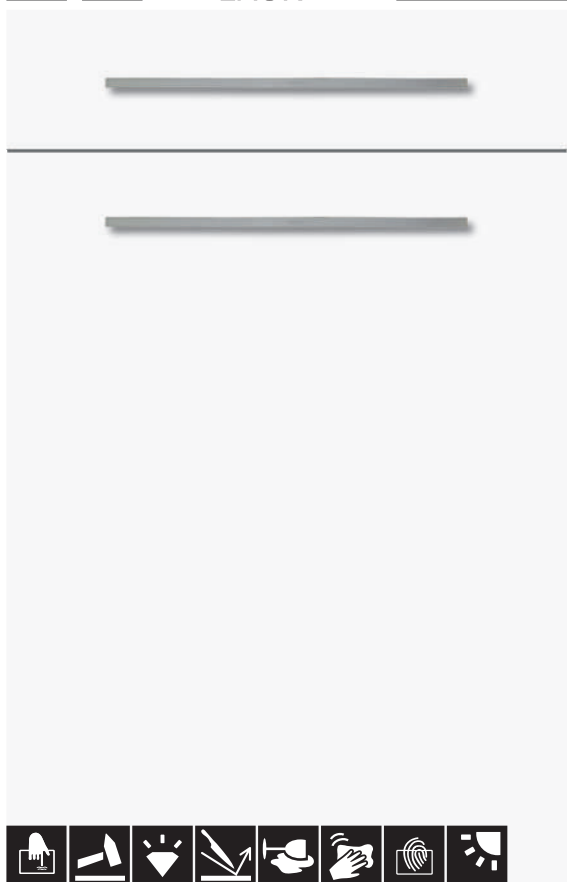
**Surface** wood texture



<b>Contoured PP edge</b>	
same decor	XL 1746
Dual	
stainless steel facing	XL 1749
<b>Reference carcass</b>	
<b>K270S</b>	Elegant walnut effect

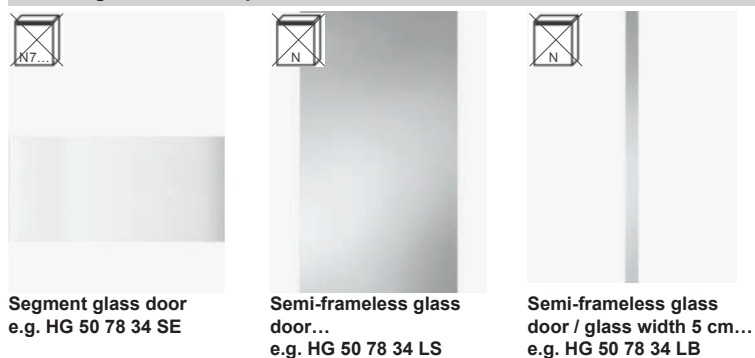
**Visible sides**  
**K270S**  
Elegant walnut effect

**XL** **GL** **DIRECT LACK** << 31-119 cm >>



**Front decor** DIRECTLACK snow white matt lacquered (rear in same colour)  
**Surface** smooth (matt)  
**Front thickness** 19 mm  
**Door shape** 14,240 kg/sqm excluding handle weight (see handles) straight, 4 sides with contoured PP edge, 1.3 mm PUR edge gluing  
**Front material** MDF substrate, coated with melamine resin, with high-quality lacquered surface

Available glass doors for specific models



Segment glass door e.g. HG 50 78 34 SE

Semi-frameless glass door... e.g. HG 50 78 34 LS

Semi-frameless glass door / glass width 5 cm... e.g. HG 50 78 34 LB

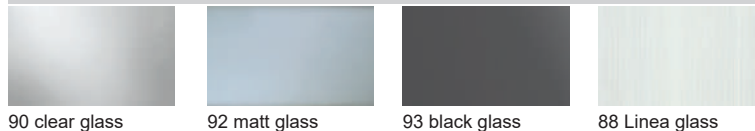
Reference carcass

**K160F**  
Snow white

Visible sides

**A160M**  
Snow White

Available glass versions



90 clear glass

92 matt glass

93 black glass

88 Linea glass

Contoured PP edge

same decor



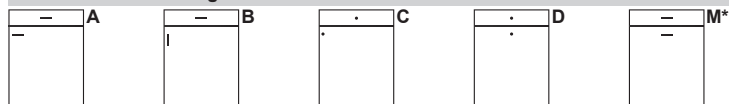
XL 2621

stainless steel facing



XL 2624

Available handle arrangements



\* = Standard finish

Grip ledges



N 400, N 475,  
N 485,  
N 700, N 775  
N 900 N 975,





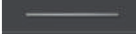

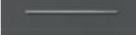


Handles

cornices / light pelmets

Dual



XL 2622

<p><b>Front decor</b> DIRECTLACK premium white matt</p> <p><b>Surface</b> smooth (matt)</p>  <table border="1"> <tr><td><b>Contoured PP edge</b></td><td></td></tr> <tr><td>same decor</td><td>XL 2626</td></tr> <tr><td>Dual</td><td>XL 2627</td></tr> <tr><td>stainless steel facing</td><td>XL 2629</td></tr> </table> <p><b>Reference carcass</b> K039P Premium white</p> <p><b>Visible sides</b> A039M Premium white</p>	<b>Contoured PP edge</b>		same decor	XL 2626	Dual	XL 2627	stainless steel facing	XL 2629	<p><b>Front decor</b> DIRECTLACK white agate matt</p> <p><b>Surface</b> smooth (matt)</p>  <table border="1"> <tr><td><b>Contoured PP edge</b></td><td></td></tr> <tr><td>same decor</td><td>XL 2631</td></tr> <tr><td>Dual</td><td></td></tr> <tr><td>stainless steel facing</td><td>XL 2634</td></tr> </table> <p><b>Reference carcass</b> K178F White Agate</p> <p><b>Visible sides</b> A178M White Agate</p>	<b>Contoured PP edge</b>		same decor	XL 2631	Dual		stainless steel facing	XL 2634	<p><b>Front decor</b> DIRECTLACK Macaron matt</p> <p><b>Surface</b> smooth (matt)</p>  <table border="1"> <tr><td><b>Contoured PP edge</b></td><td></td></tr> <tr><td>same decor</td><td>XL 2636</td></tr> <tr><td>Dual</td><td>XL 2637</td></tr> <tr><td>stainless steel facing</td><td>XL 2639</td></tr> </table> <p><b>Reference carcass</b> K076P Macaron</p> <p><b>Visible sides</b> A076M Macaron</p>	<b>Contoured PP edge</b>		same decor	XL 2636	Dual	XL 2637	stainless steel facing	XL 2639
<b>Contoured PP edge</b>																										
same decor	XL 2626																									
Dual	XL 2627																									
stainless steel facing	XL 2629																									
<b>Contoured PP edge</b>																										
same decor	XL 2631																									
Dual																										
stainless steel facing	XL 2634																									
<b>Contoured PP edge</b>																										
same decor	XL 2636																									
Dual	XL 2637																									
stainless steel facing	XL 2639																									
<p><b>Front decor</b> DIRECTLACK black matt</p> <p><b>Surface</b> smooth (matt)</p>  <table border="1"> <tr><td><b>Contoured PP edge</b></td><td></td></tr> <tr><td>same decor</td><td>XL 2641</td></tr> <tr><td>Dual</td><td></td></tr> <tr><td>stainless steel facing</td><td>XL 2644</td></tr> </table> <p><b>Reference carcass</b> K075P Black</p> <p><b>Visible sides</b> A075M Black</p>	<b>Contoured PP edge</b>		same decor	XL 2641	Dual		stainless steel facing	XL 2644	<p><b>Front decor</b> DIRECTLACK graphite black matt</p> <p><b>Surface</b> smooth (matt)</p>  <table border="1"> <tr><td><b>Contoured PP edge</b></td><td></td></tr> <tr><td>same decor</td><td>XL 2646</td></tr> <tr><td>Dual</td><td></td></tr> <tr><td>stainless steel facing</td><td>XL 2649</td></tr> </table> <p><b>Reference carcass</b> K043P Graphite Black</p> <p><b>Visible sides</b> A043M Graphite Black</p>	<b>Contoured PP edge</b>		same decor	XL 2646	Dual		stainless steel facing	XL 2649	<p><b>Front decor</b> DIRECTLACK light pepper matt</p> <p><b>Surface</b> smooth (matt)</p>  <table border="1"> <tr><td><b>Contoured PP edge</b></td><td></td></tr> <tr><td>same decor</td><td>XL 2656</td></tr> <tr><td>Dual</td><td></td></tr> <tr><td>stainless steel facing</td><td>XL 2659</td></tr> </table> <p><b>Reference carcass</b> K218P Light Pepper</p> <p><b>Visible sides</b> A218M Light Pepper</p>	<b>Contoured PP edge</b>		same decor	XL 2656	Dual		stainless steel facing	XL 2659
<b>Contoured PP edge</b>																										
same decor	XL 2641																									
Dual																										
stainless steel facing	XL 2644																									
<b>Contoured PP edge</b>																										
same decor	XL 2646																									
Dual																										
stainless steel facing	XL 2649																									
<b>Contoured PP edge</b>																										
same decor	XL 2656																									
Dual																										
stainless steel facing	XL 2659																									
<p><b>Front decor</b> DIRECTLACK art pepper matt</p> <p><b>Surface</b> smooth (matt)</p>  <table border="1"> <tr><td><b>Contoured PP edge</b></td><td></td></tr> <tr><td>same decor</td><td>XL 2661</td></tr> <tr><td>Dual</td><td></td></tr> <tr><td>stainless steel facing</td><td>XL 2664</td></tr> </table> <p><b>Reference carcass</b> K230P Art Pepper</p> <p><b>Visible sides</b> A230M Art Pepper</p>	<b>Contoured PP edge</b>		same decor	XL 2661	Dual		stainless steel facing	XL 2664	<p><b>Front decor</b> Light Nude DIRECTLACK matt lacquered</p> <p><b>Surface</b> smooth (matt)</p>  <table border="1"> <tr><td><b>Contoured PP edge</b></td><td></td></tr> <tr><td>same decor</td><td>XL 2676</td></tr> <tr><td>Dual</td><td></td></tr> <tr><td>stainless steel facing</td><td>XL 2679</td></tr> </table> <p><b>Reference carcass</b> K248P Light Nude</p> <p><b>Visible sides</b> A248M Light Nude</p>	<b>Contoured PP edge</b>		same decor	XL 2676	Dual		stainless steel facing	XL 2679	<p><b>Front decor</b> DIRECTLACK Fango matt lacquered</p> <p><b>Surface</b> smooth (matt)</p>  <table border="1"> <tr><td><b>Contoured PP edge</b></td><td></td></tr> <tr><td>same decor</td><td>XL 2681</td></tr> <tr><td>Dual</td><td></td></tr> <tr><td>stainless steel facing</td><td>XL 2684</td></tr> </table> <p><b>Reference carcass</b> K263P Fango</p> <p><b>Visible sides</b> A263M Fango</p>	<b>Contoured PP edge</b>		same decor	XL 2681	Dual		stainless steel facing	XL 2684
<b>Contoured PP edge</b>																										
same decor	XL 2661																									
Dual																										
stainless steel facing	XL 2664																									
<b>Contoured PP edge</b>																										
same decor	XL 2676																									
Dual																										
stainless steel facing	XL 2679																									
<b>Contoured PP edge</b>																										
same decor	XL 2681																									
Dual																										
stainless steel facing	XL 2684																									

**XL** **GL** **DIRECT LACK** << 31-119 cm >>



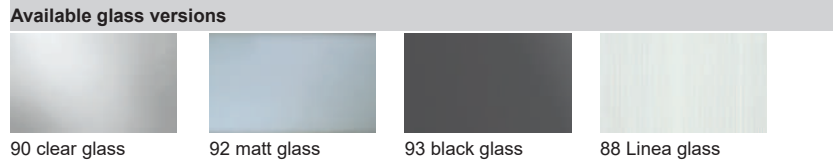
**Front decor** DIRECTLACK high-gloss snow white (rear in same colour)  
**Surface** smooth (high-gloss)  
**Front thickness** 19 mm  
**Door shape** 14,200 kg/sqm excluding handle weight (see handles) 14,394 straight, 4 sides with contoured PP edge 1.3 mm, PUR edge gluing  
**Front material** MDF substrate, coated with melamine resin, with high-quality lacquered surface

Available glass doors for specific models



**Reference carcass**  
**K160G**  
 Snow White Gloss

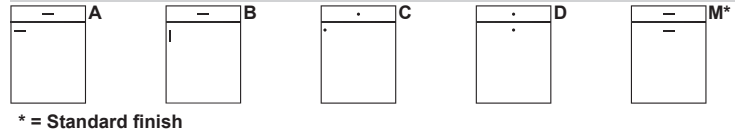
**Visible sides**  
**L160H**  
 Snow White



Contoured PP edge




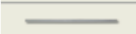
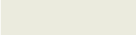
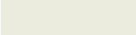
Available handle arrangements











**Grip ledges** **Handles** **cornices / light pelmets**





N 400, N 475, N 485, N 700, N 775, N 900 N 975,







<b>Front decor</b>	DIRECTLACK high-gloss premium white
<b>Surface</b>	smooth (high-gloss)
	<b>Contoured PP edge</b>
	same decor <b>XL 2706</b>
	Dual <b>XL 2707</b>
	stainless steel facing <b>XL 2709</b>
<b>Reference carcass</b>	
<b>K039G</b> Premium white glossy	
<b>Visible sides</b>	
<b>L039H</b> Premium white	

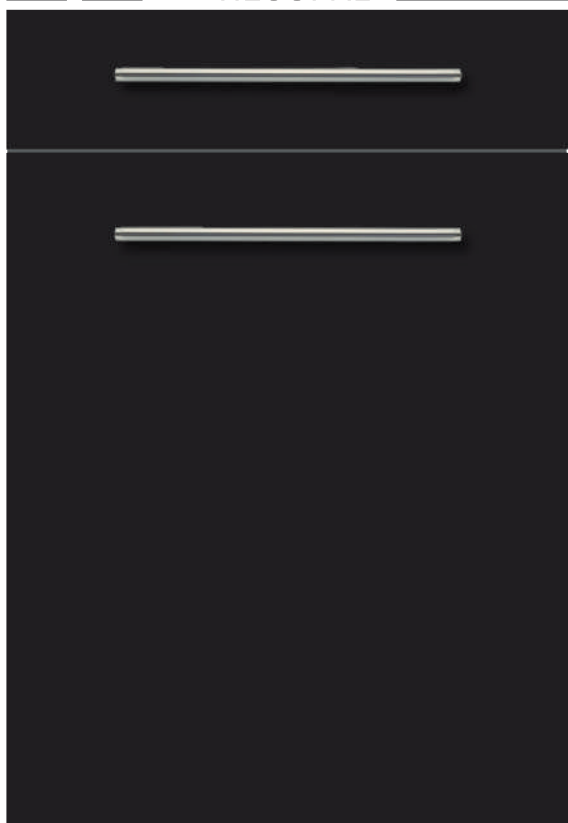
<b>Front decor</b>	DIRECTLACK high-gloss white agate
<b>Surface</b>	smooth (high-gloss)
	<b>Contoured PP edge</b>
	same decor <b>XL 2711</b>
	Dual <b>XL 2714</b>
	stainless steel facing <b>XL 2714</b>
<b>Reference carcass</b>	
<b>K178F</b> White Agate	
<b>Visible sides</b>	
<b>L178H</b> White Agate	

<b>Front decor</b>	DIRECTLACK high-gloss Macaron
<b>Surface</b>	smooth (high-gloss)
	<b>Contoured PP edge</b>
	same decor <b>XL 2721</b>
	Dual <b>XL 2722</b>
	stainless steel facing <b>XL 2724</b>
<b>Reference carcass</b>	
<b>K076P</b> Macaron	
<b>Visible sides</b>	
<b>L076H</b> Macaron	

<b>Front decor</b>	DIRECTLACK high-gloss light pepper
<b>Surface</b>	smooth (high-gloss)
	<b>Contoured PP edge</b>
	same decor <b>XL 2746</b>
	Dual <b>XL 2749</b>
	stainless steel facing <b>XL 2749</b>
<b>Reference carcass</b>	
<b>K218P</b> Light Pepper	
<b>Visible sides</b>	
<b>L218H</b> Light Pepper	

<b>Front decor</b>	Light Nude DIRECTLACK high-gloss
<b>Surface</b>	smooth (high-gloss)
	<b>Contoured PP edge</b>
	same decor <b>XL 2751</b>
	Dual <b>XL 2754</b>
	stainless steel facing <b>XL 2754</b>
<b>Reference carcass</b>	
<b>K248P</b> Light Nude	
<b>Visible sides</b>	
<b>L248H</b> Light Nude	

**XL** **GL** ORIGINAL RESOPAL® << 31-119 cm >>

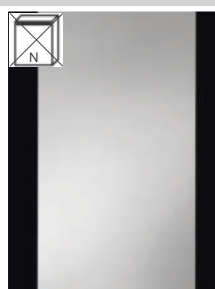


**Front decor** black super matt  
(rear texture in same colour)  
**Surface** smooth (matt)  
**Front thickness** 20 mm  
**Door shape** 14,200 kg/sqm excluding handle weight (see handles)  
straight, 4 sides with contoured PP edge 1.3 mm,  
PUR edge gluing  
**Front material** Multi-layer particle board, both sides with laminate "RESOPAL" 0.8 mm

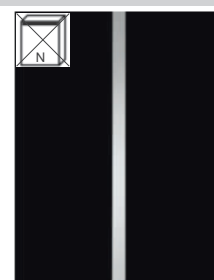
Available glass doors for specific models



Segment glass door  
e.g. HG 50 78 34 SE

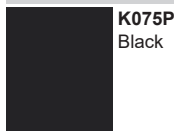


Semi-frameless glass  
door...  
e.g. HG 50 78 34 LS



Semi-frameless glass  
door / glass width 5 cm...  
e.g. HG 50 78 34 LB

Reference carcass



**K075P**  
Black

Visible sides



**I075M**  
Black super matt

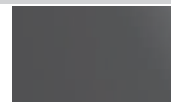
Available glass versions



90 clear glass



92 matt glass



93 black glass



88 Linea glass

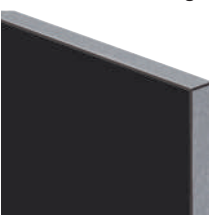
Contoured PP edge

same decor



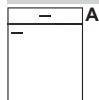
XL 31006

stainless steel facing

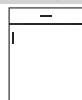


XL 31009

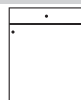
Available handle arrangements



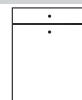
A



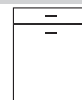
B



C



D



M\*

\* = Standard finish

Grip ledges



N 400, N 475,  
N 485,  
N 700, N 775  
N 900 N 975,

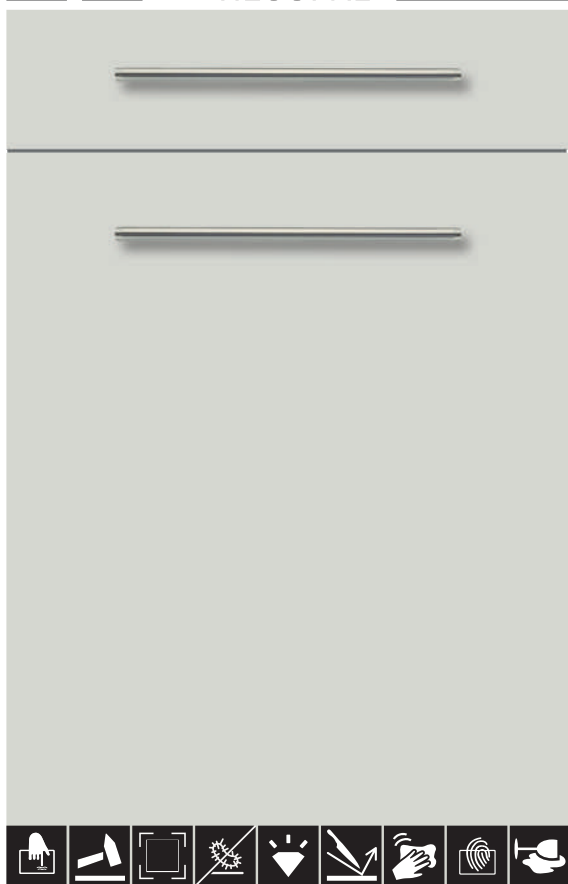
Handles

cornices / light pelmets

Dual

<p><b>Front decor</b> Jura Grey super matt</p> <p><b>Surface</b> smooth (matt)</p> <table border="1"> <tr><td></td><td><b>Contoured PP edge</b></td></tr> <tr><td></td><td>same decor <b>XL 31001</b></td></tr> <tr><td></td><td>Dual</td></tr> <tr><td></td><td>stainless steel facing <b>XL 31004</b></td></tr> <tr><td colspan="2"><b>Reference carcass</b></td></tr> <tr><td colspan="2"><b>K006P</b> Light Grey</td></tr> </table> <p><b>Visible sides</b> <b>I139M</b> Jura Grey super matt</p>		<b>Contoured PP edge</b>		same decor <b>XL 31001</b>		Dual		stainless steel facing <b>XL 31004</b>	<b>Reference carcass</b>		<b>K006P</b> Light Grey		<p><b>Front decor</b> Anthracite super matt</p> <p><b>Surface</b> smooth (matt)</p> <table border="1"> <tr><td></td><td><b>Contoured PP edge</b></td></tr> <tr><td></td><td>same decor <b>XL 31011</b></td></tr> <tr><td></td><td>Dual</td></tr> <tr><td></td><td>stainless steel facing <b>XL 31014</b></td></tr> <tr><td colspan="2"><b>Reference carcass</b></td></tr> <tr><td colspan="2"><b>K043P</b> Graphite Black</td></tr> </table> <p><b>Visible sides</b> <b>I140M</b> Anthracite super matt</p>		<b>Contoured PP edge</b>		same decor <b>XL 31011</b>		Dual		stainless steel facing <b>XL 31014</b>	<b>Reference carcass</b>		<b>K043P</b> Graphite Black		<p><b>Front decor</b> Titanium grey super matt</p> <p><b>Surface</b> smooth (matt)</p> <table border="1"> <tr><td></td><td><b>Contoured PP edge</b></td></tr> <tr><td></td><td>same decor <b>XL 31016</b></td></tr> <tr><td></td><td>Dual</td></tr> <tr><td></td><td>stainless steel facing <b>XL 31019</b></td></tr> <tr><td colspan="2"><b>Reference carcass</b></td></tr> <tr><td colspan="2"><b>K075P</b> Black</td></tr> </table> <p><b>Visible sides</b> <b>I138M</b> Titanium grey super matt</p>		<b>Contoured PP edge</b>		same decor <b>XL 31016</b>		Dual		stainless steel facing <b>XL 31019</b>	<b>Reference carcass</b>		<b>K075P</b> Black	
	<b>Contoured PP edge</b>																																					
	same decor <b>XL 31001</b>																																					
	Dual																																					
	stainless steel facing <b>XL 31004</b>																																					
<b>Reference carcass</b>																																						
<b>K006P</b> Light Grey																																						
	<b>Contoured PP edge</b>																																					
	same decor <b>XL 31011</b>																																					
	Dual																																					
	stainless steel facing <b>XL 31014</b>																																					
<b>Reference carcass</b>																																						
<b>K043P</b> Graphite Black																																						
	<b>Contoured PP edge</b>																																					
	same decor <b>XL 31016</b>																																					
	Dual																																					
	stainless steel facing <b>XL 31019</b>																																					
<b>Reference carcass</b>																																						
<b>K075P</b> Black																																						
<p><b>Front decor</b> cool white super matt</p> <p><b>Surface</b> smooth (matt)</p> <table border="1"> <tr><td></td><td><b>Contoured PP edge</b></td></tr> <tr><td></td><td>same decor <b>XL 31021</b></td></tr> <tr><td></td><td>Dual <b>XL 31022</b></td></tr> <tr><td></td><td>stainless steel facing <b>XL 31024</b></td></tr> <tr><td colspan="2"><b>Reference carcass</b></td></tr> <tr><td colspan="2"><b>K160F</b> Snow white</td></tr> </table> <p><b>Visible sides</b> <b>I141M</b> cool white super matt</p>		<b>Contoured PP edge</b>		same decor <b>XL 31021</b>		Dual <b>XL 31022</b>		stainless steel facing <b>XL 31024</b>	<b>Reference carcass</b>		<b>K160F</b> Snow white		<p><b>Front decor</b> Premium white super matt</p> <p><b>Surface</b> smooth (matt)</p> <table border="1"> <tr><td></td><td><b>Contoured PP edge</b></td></tr> <tr><td></td><td>same decor <b>XL 31026</b></td></tr> <tr><td></td><td>Dual <b>XL 31027</b></td></tr> <tr><td></td><td>stainless steel facing <b>XL 31029</b></td></tr> <tr><td colspan="2"><b>Reference carcass</b></td></tr> <tr><td colspan="2"><b>K039P</b> Premium white</td></tr> </table> <p><b>Visible sides</b> <b>I039M</b> Premium white super matt</p>		<b>Contoured PP edge</b>		same decor <b>XL 31026</b>		Dual <b>XL 31027</b>		stainless steel facing <b>XL 31029</b>	<b>Reference carcass</b>		<b>K039P</b> Premium white		<p><b>Front decor</b> Light Powder super matt</p> <p><b>Surface</b> smooth (matt)</p> <table border="1"> <tr><td></td><td><b>Contoured PP edge</b></td></tr> <tr><td></td><td>same decor <b>XL 31031</b></td></tr> <tr><td></td><td>Dual</td></tr> <tr><td></td><td>stainless steel facing <b>XL 31034</b></td></tr> <tr><td colspan="2"><b>Reference carcass</b></td></tr> <tr><td colspan="2"><b>K075P</b> Black</td></tr> </table> <p><b>Visible sides</b> <b>I240M</b> Light Powder super matt</p>		<b>Contoured PP edge</b>		same decor <b>XL 31031</b>		Dual		stainless steel facing <b>XL 31034</b>	<b>Reference carcass</b>		<b>K075P</b> Black	
	<b>Contoured PP edge</b>																																					
	same decor <b>XL 31021</b>																																					
	Dual <b>XL 31022</b>																																					
	stainless steel facing <b>XL 31024</b>																																					
<b>Reference carcass</b>																																						
<b>K160F</b> Snow white																																						
	<b>Contoured PP edge</b>																																					
	same decor <b>XL 31026</b>																																					
	Dual <b>XL 31027</b>																																					
	stainless steel facing <b>XL 31029</b>																																					
<b>Reference carcass</b>																																						
<b>K039P</b> Premium white																																						
	<b>Contoured PP edge</b>																																					
	same decor <b>XL 31031</b>																																					
	Dual																																					
	stainless steel facing <b>XL 31034</b>																																					
<b>Reference carcass</b>																																						
<b>K075P</b> Black																																						
<p><b>Front decor</b> Dark Powder super matt</p> <p><b>Surface</b> smooth (matt)</p> <table border="1"> <tr><td></td><td><b>Contoured PP edge</b></td></tr> <tr><td></td><td>same decor <b>XL 31036</b></td></tr> <tr><td></td><td>Dual</td></tr> <tr><td></td><td>stainless steel facing <b>XL 31039</b></td></tr> <tr><td colspan="2"><b>Reference carcass</b></td></tr> <tr><td colspan="2"><b>K075P</b> Black</td></tr> </table> <p><b>Visible sides</b> <b>I241M</b> Dark Powder super matt</p>		<b>Contoured PP edge</b>		same decor <b>XL 31036</b>		Dual		stainless steel facing <b>XL 31039</b>	<b>Reference carcass</b>		<b>K075P</b> Black		<p><b>Front decor</b> Moonlight Green super matt</p> <p><b>Surface</b> smooth (matt)</p> <table border="1"> <tr><td></td><td><b>Contoured PP edge</b></td></tr> <tr><td></td><td>same decor <b>XL 32001</b></td></tr> <tr><td></td><td>Dual</td></tr> <tr><td></td><td>stainless steel facing <b>XL 32004</b></td></tr> <tr><td colspan="2"><b>Reference carcass</b></td></tr> <tr><td colspan="2"><b>K235P</b> Titan Steel</td></tr> </table> <p><b>Visible sides</b> <b>I253M</b> Moonlight Green super matt</p>		<b>Contoured PP edge</b>		same decor <b>XL 32001</b>		Dual		stainless steel facing <b>XL 32004</b>	<b>Reference carcass</b>		<b>K235P</b> Titan Steel		<p><b>Front decor</b> Macaron Powder super matt</p> <p><b>Surface</b> smooth (matt)</p> <table border="1"> <tr><td></td><td><b>Contoured PP edge</b></td></tr> <tr><td></td><td>same decor <b>XL 32011</b></td></tr> <tr><td></td><td>Dual</td></tr> <tr><td></td><td>stainless steel facing <b>XL 32014</b></td></tr> <tr><td colspan="2"><b>Reference carcass</b></td></tr> <tr><td colspan="2"><b>K076P</b> Macaron</td></tr> </table> <p><b>Visible sides</b> <b>I076M</b> Macaron powder</p>		<b>Contoured PP edge</b>		same decor <b>XL 32011</b>		Dual		stainless steel facing <b>XL 32014</b>	<b>Reference carcass</b>		<b>K076P</b> Macaron	
	<b>Contoured PP edge</b>																																					
	same decor <b>XL 31036</b>																																					
	Dual																																					
	stainless steel facing <b>XL 31039</b>																																					
<b>Reference carcass</b>																																						
<b>K075P</b> Black																																						
	<b>Contoured PP edge</b>																																					
	same decor <b>XL 32001</b>																																					
	Dual																																					
	stainless steel facing <b>XL 32004</b>																																					
<b>Reference carcass</b>																																						
<b>K235P</b> Titan Steel																																						
	<b>Contoured PP edge</b>																																					
	same decor <b>XL 32011</b>																																					
	Dual																																					
	stainless steel facing <b>XL 32014</b>																																					
<b>Reference carcass</b>																																						
<b>K076P</b> Macaron																																						
<p><b>Front decor</b> Brown Powder super matt</p> <p><b>Surface</b> smooth (matt)</p> <table border="1"> <tr><td></td><td><b>Contoured PP edge</b></td></tr> <tr><td></td><td>same decor <b>XL 32016</b></td></tr> <tr><td></td><td>Dual</td></tr> <tr><td></td><td>stainless steel facing <b>XL 32019</b></td></tr> <tr><td colspan="2"><b>Reference carcass</b></td></tr> <tr><td colspan="2"><b>K075P</b> Black</td></tr> </table> <p><b>Visible sides</b> <b>I267M</b> Brown Powder super matt</p>		<b>Contoured PP edge</b>		same decor <b>XL 32016</b>		Dual		stainless steel facing <b>XL 32019</b>	<b>Reference carcass</b>		<b>K075P</b> Black		<p><b>Front decor</b> Nature Powder super matt</p> <p><b>Surface</b> smooth (matt)</p> <table border="1"> <tr><td></td><td><b>Contoured PP edge</b></td></tr> <tr><td></td><td>same decor <b>XL 32021</b></td></tr> <tr><td></td><td>Dual</td></tr> <tr><td></td><td>stainless steel facing <b>XL 32024</b></td></tr> <tr><td colspan="2"><b>Reference carcass</b></td></tr> <tr><td colspan="2"><b>K230P</b> Art Pepper</td></tr> </table> <p><b>Visible sides</b> <b>I268M</b> Nature Powder super matt</p>		<b>Contoured PP edge</b>		same decor <b>XL 32021</b>		Dual		stainless steel facing <b>XL 32024</b>	<b>Reference carcass</b>		<b>K230P</b> Art Pepper														
	<b>Contoured PP edge</b>																																					
	same decor <b>XL 32016</b>																																					
	Dual																																					
	stainless steel facing <b>XL 32019</b>																																					
<b>Reference carcass</b>																																						
<b>K075P</b> Black																																						
	<b>Contoured PP edge</b>																																					
	same decor <b>XL 32021</b>																																					
	Dual																																					
	stainless steel facing <b>XL 32024</b>																																					
<b>Reference carcass</b>																																						
<b>K230P</b> Art Pepper																																						

**XL** **GL** ORIGINAL RESOPAL® << 31-119 cm >>



**Front decor** Jura Grey super matt  
(rear texture in same colour)  
**Surface** smooth (matt)  
**Front thickness** 20 mm  
**Door shape** 14,200 kg/sqm excluding handle weight (see handles)  
straight, 4 sides with contoured PP edge 1.3 mm,  
PUR edge gluing  
**Front material** Multi-layer particle board, both sides with laminate "RESOPAL" 0.8 mm

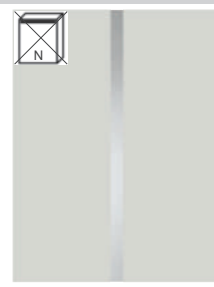
### Available glass doors for specific models



**Segment glass door**  
e.g. HG 50 78 34 SE



**Semi-frameless glass door...**  
e.g. HG 50 78 34 LS



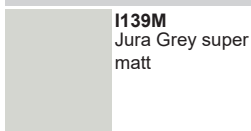
**Semi-frameless glass door / glass width 5 cm...**  
e.g. HG 50 78 34 LB

### Reference carcass



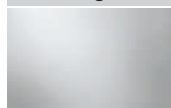
**K006P**  
Light Grey

### Visible sides

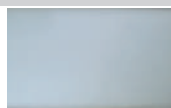


**I139M**  
Jura Grey super matt

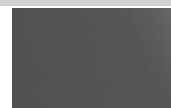
### Available glass versions



90 clear glass



92 matt glass



93 black glass



88 Linea glass

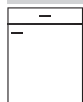
### Contoured PP edge

wood decorative edge

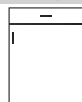


XL 33000

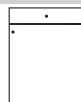
### Available handle arrangements



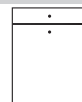
A



B



C



D



M\*

\* = Standard finish

### Grip ledges



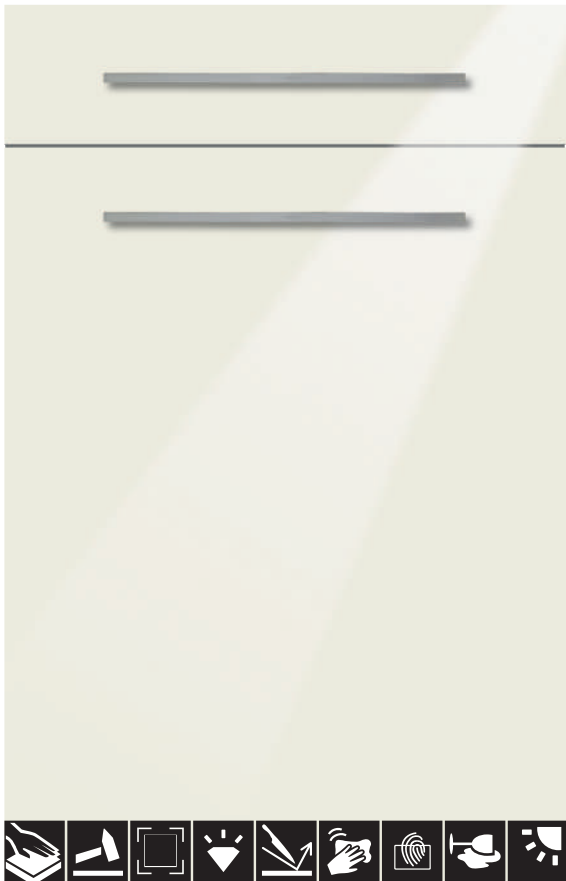
N 400, N 475,  
N 485,  
N 700, N 775  
N 900 N 975,

### Handles

### cornices / light pelmets

<p><b>Front decor</b> black super matt</p> <p><b>Surface</b> smooth (matt)</p>  <p><b>Contoured PP edge</b> wood decorative edge XL 33005</p> <p><b>Reference carcass</b> K075P Black</p> <p><b>Visible sides</b> I075M Black super matt</p>	<p><b>Front decor</b> Anthracite super matt</p> <p><b>Surface</b> smooth (matt)</p>  <p><b>Contoured PP edge</b> wood decorative edge XL 33010</p> <p><b>Reference carcass</b> K043P Graphite Black</p> <p><b>Visible sides</b> I140M Anthracite super matt</p>	<p><b>Front decor</b> Titanium grey super matt</p> <p><b>Surface</b> smooth (matt)</p>  <p><b>Contoured PP edge</b> wood decorative edge XL 33015</p> <p><b>Reference carcass</b> K075P Black</p> <p><b>Visible sides</b> I138M Titanium grey super matt</p>
<p><b>Front decor</b> cool white super matt</p> <p><b>Surface</b> smooth (matt)</p>  <p><b>Contoured PP edge</b> wood decorative edge XL 33020</p> <p><b>Reference carcass</b> K160F Snow white</p> <p><b>Visible sides</b> I141M cool white super matt</p>	<p><b>Front decor</b> Premium white super matt</p> <p><b>Surface</b> smooth (matt)</p>  <p><b>Contoured PP edge</b> wood decorative edge XL 33025</p> <p><b>Reference carcass</b> K039P Premium white</p> <p><b>Visible sides</b> I039M Premium white super matt</p>	<p><b>Front decor</b> Light Powder super matt</p> <p><b>Surface</b> smooth (matt)</p>  <p><b>Contoured PP edge</b> wood decorative edge XL 33030</p> <p><b>Reference carcass</b> K075P Black</p> <p><b>Visible sides</b> I240M Light Powder super matt</p>
<p><b>Front decor</b> Dark Powder super matt</p> <p><b>Surface</b> smooth (matt)</p>  <p><b>Contoured PP edge</b> wood decorative edge XL 33035</p> <p><b>Reference carcass</b> K075P Black</p> <p><b>Visible sides</b> I241M Dark Powder super matt</p>	<p><b>Front decor</b> Moonlight Green super matt</p> <p><b>Surface</b> smooth (matt)</p>  <p><b>Contoured PP edge</b> wood decorative edge XL 33050</p> <p><b>Reference carcass</b> K235P Titan Steel</p> <p><b>Visible sides</b> I253M Moonlight Green super matt</p>	<p><b>Front decor</b> Brown Powder super matt</p> <p><b>Surface</b> smooth (matt)</p>  <p><b>Contoured PP edge</b> wood decorative edge XL 33055</p> <p><b>Reference carcass</b> K075P Black</p> <p><b>Visible sides</b> I267M Brown Powder super matt</p>
<p><b>Front decor</b> Nature Powder super matt</p> <p><b>Surface</b> smooth (matt)</p>  <p><b>Contoured PP edge</b> wood decorative edge XL 33060</p> <p><b>Reference carcass</b> K230P Art Pepper</p> <p><b>Visible sides</b> I268M Nature Powder super matt</p>	<p><b>Front decor</b> Macaron Powder super matt</p> <p><b>Surface</b> smooth (matt)</p>  <p><b>Contoured PP edge</b> wood decorative edge XL 33065</p> <p><b>Reference carcass</b> K076P Macaron</p> <p><b>Visible sides</b> I076M Macaron Powder super matt</p>	

**XL** **GL** ORIGINAL RESOPAL® << 31-119 cm >>



**Front decor** high-gloss premium white (rear in premium white with „ORIGINALRESOPAL“ lettering)

**Surface** smooth (high-gloss)

**Front thickness** 20 mm

**Door shape** 14,977 kg/sqm excluding handle weight (see handles) straight, 4 sides with contoured PP edge 1.3 mm, PUR edge gluing

**Front material** Multi-layer particle board, both sides with laminate “RESOPAL” 0.8 mm

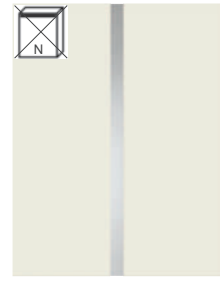
**Available glass doors for specific models**



**Segment glass door**  
e.g. HG 50 78 34 SE



**Semi-frameless glass door...**  
e.g. HG 50 78 34 LS



**Semi-frameless glass door / glass width 5 cm...**  
e.g. HG 50 78 34 LB

**Reference carcass**

**K039G**  
Premium white glossy

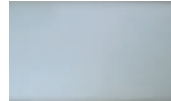
**Visible sides**

**K039G**  
Premium white glossy

**Available glass versions**



90 clear glass



92 matt glass



93 black glass



88 Linea glass

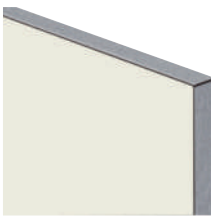
**Contoured PP edge**

same decor



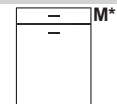
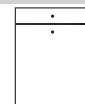
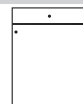
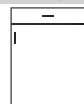
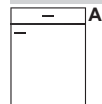
XL 3211

stainless steel facing



XL 3214

**Available handle arrangements**



\* = Standard finish

**Grip ledges**

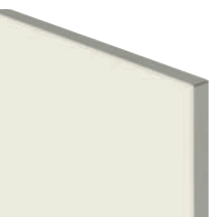


N 400, N 475,  
N 485,  
N 700, N 775  
N 900 N 975,

**Handles**

**cornices / light pelmets**

Dual



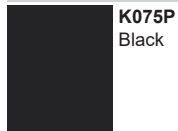
XL 3212



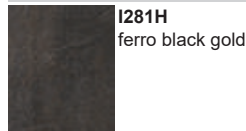
**XL** **GL** << 31-119 cm >>



**Reference carcass**



**Visible sides**



**Contoured PP edge**

same decor



XL 3001

stainless steel facing



XL 3004

**XL 3001-3004**

**Front decor** ferro black gold  
(rear in same colour)  
**Surface** Smooth  
**Front thickness** 19 mm  
13,860 kg/sqm excluding handle weight (see handles)  
**Door shape** straight, 4 sides with contoured PP edge 1.3 mm,  
PUR edge gluing  
**Front material** Multi-layer particle board both sides with laminate

**Available glass doors for specific models**



Segment glass door  
e.g. HG 50 78 34 SE



Semi-frameless glass  
door...  
e.g. HG 50 78 34 LS



Semi-frameless glass  
door / glass width 5 cm...  
e.g. HG 50 78 34 LB

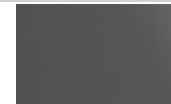
**Available glass versions**



90 clear glass



92 matt glass

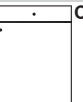
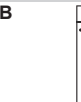
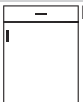
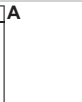


93 black glass



88 Linea glass

**Available handle arrangements**



\* = Standard finish

**Grip ledges**



N 400, N 475,  
N 485,  
N 700, N 775  
N 900 N 975,

**Handles**

**cornices / light pelmets**

**Front decor** Natural onyx effect

**Surface** Smooth



**Contoured PP edge**

same decor **XL 3011**  
Dual  
stainless steel facing **XL 3014**

**Reference carcass**

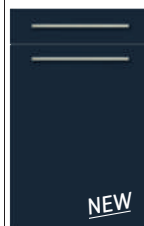
**K058P**  
Magic-grey

**Visible sides**

**I273H**  
Natural onyx effect

**Front decor** Navyblue

**Surface** Smooth



**Contoured PP edge**

same decor **XL 3016**  
Dual  
stainless steel facing **XL 3019**

**Reference carcass**

**K235P**  
Titan Steel

**Visible sides**

**I274H**  
Navyblue

**Front decor** Smoke Powder

**Surface** Smooth



**Contoured PP edge**

same decor **XL 3191**  
Dual  
stainless steel facing **XL 3194**

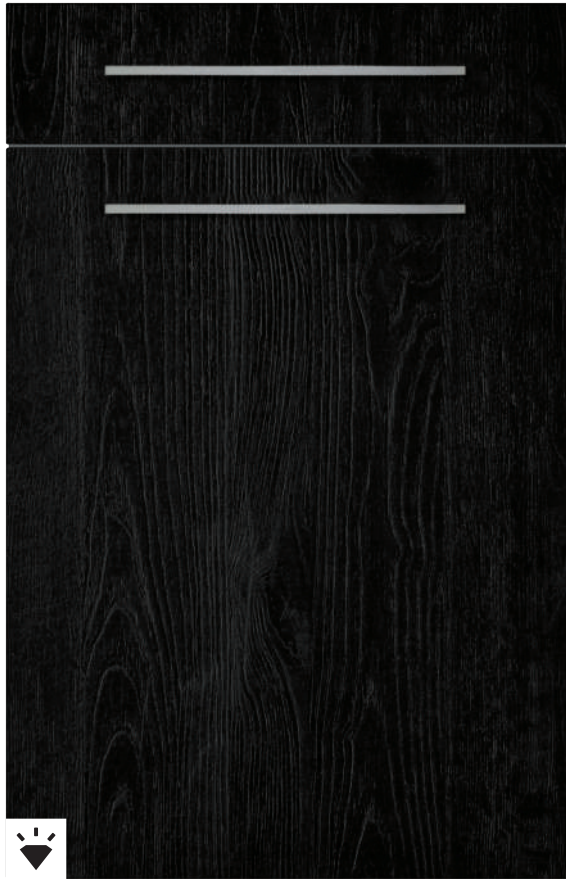
**Reference carcass**

**K075P**  
Black

**Visible sides**

**I280H**  
Smoke Powder

**XL** **GL** << 31-119 cm >>



**XL 3036**

**Front decor** Sherwood oak effect black  
(rear in same colour)  
**Surface** wood texture  
**Front thickness** 19 mm  
 12,403 kg/sqm excluding handle weight (see handles)  
**Door shape** straight, 4 sides with contoured PP edge,  
 1.3 mm PUR edge gluing  
**Front material** Multi-layer particle board, coated with melamine resin in multiple-ply design

**Available glass doors for specific models**



**Segment glass door**  
e.g. HG 50 78 34 SE



**Semi-frameless glass door...**  
e.g. HG 50 78 34 LS



**Semi-frameless glass door / glass width 5 cm...**  
e.g. HG 50 78 34 LB

**Reference carcass**



**K075P**  
Black

**Visible sides**

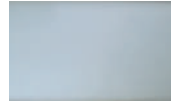


**D176S**  
Sherwood Oak  
Repro. Black

**Available glass versions**



90 clear glass



92 matt glass

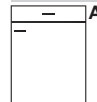


93 black glass



88 Linea glass

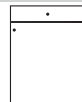
**Available handle arrangements**



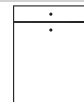
**A**



**B**



**C**



**D**



**M\***

\* = Standard finish

**Grip ledges**



N 400, N 475,  
N 485,  
N 900 N 975,  
N 700, N 775

**Handles**

**cornices / light pelmets**

**Front decor** Sherwood oak effect sepia grey

**Surface** wood texture



**XL 3041**

**Reference carcass**

**K075P**  
Black

**Visible sides**

**D202S**  
Sherwood Oak Repro Sepia Grey

**XL** **GL** << 31-119 cm >>



**XL 3526**

**Front decor** Gavi Oak Basic stained (rear texture in same colour)  
**Surface** Veneer sealed with high-quality lacquer  
**Front thickness** 19 mm  
 13.500 kg/sqm excluding handle weight (see handles)  
**Door shape** straight, 4 sides with veneer-fitted contoured PP edge  
**Front material** multi-layer particle board, veneered on both sides

**NEW**

**Available glass doors for specific models**



**Segment glass door**  
e.g. HG 50 78 34 SE



**Semi-frameless glass door...**  
e.g. HG 50 78 34 LS



**Semi-frameless glass door / glass width 5 cm...**  
e.g. HG 50 78 34 LB

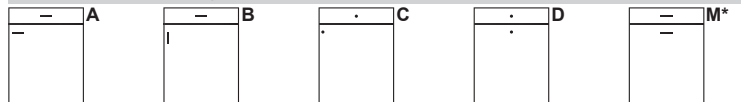
**Reference carcass**  
**K230P**  
Art Pepper

**Visible sides**  
**PW258**  
Gavi oak Basic veneer

**Available glass versions**

90 clear glass	92 matt glass	93 black glass	88 Linea glass

**Available handle arrangements**



\* = Standard finish

**Grip ledges** **Handles** **cornices / light pelmets**

N 400, N 475, N 485, N 900 N 975,

**Front decor** Dark oak stained basic  
**Surface** Smooth

**XL 3531**

**Reference carcass**  
**K075P**  
Black

**Visible sides**  
**PW259**  
Dark oak basic veneer

**NEW**



**XL 3101**

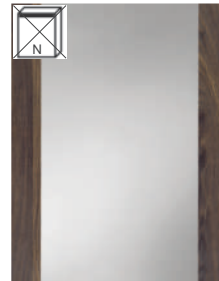
- Front decor** Bordeaux oak effect (rear in same colour)
- Surface** wood texture
- Front thickness** 19 mm
- Door shape** 12,403 kg/sqm excluding handle weight (see handles)  
straight, 4 sides with contoured PP edge,  
1.3 mm PUR edge gluing
- Front material** Multi-layer particle board, coated with melamine resin in multiple-ply design

**Note:**  
Range always without tightening fitting!

**Available glass doors for specific models**



**Segment glass door**  
e.g. HG 50 78 34 SE

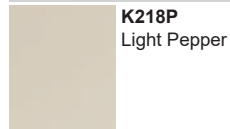


**Semi-frameless glass door...**  
e.g. HG 50 78 34 LS



**Semi-frameless glass door / glass width 5 cm...**  
e.g. HG 50 78 34 LB

**Reference carcass**



**K218P**  
Light Pepper

**Visible sides**



**D224S**  
Bordeaux oak effect

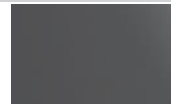
**Available glass versions**



90 clear glass



92 matt glass



93 black glass



88 Linea glass

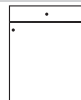
**Available handle arrangements**



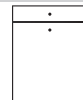
**A**



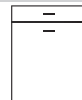
**B**



**C**



**D**



**M\***

\* = Standard finish

**Grip ledges**



- N 400, N 475,
- N 485,
- N 700, N 775
- N 900 N 975,

**Handles**

**cornices / light pelmets**

**Front decor** Burnt Wood effect

**Surface** wood texture



**XL 3111**

**Note:**  
Range always without tightening fitting!

**Reference carcass**

**K075P**  
Black

**Visible sides**

**D147S**  
Burnt Wood effect



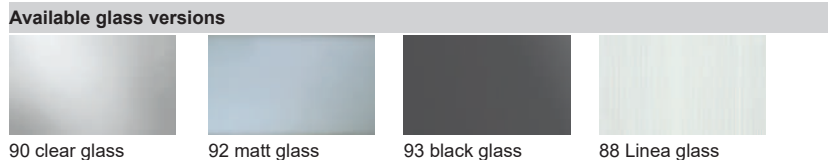
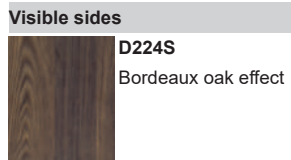
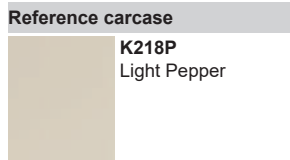
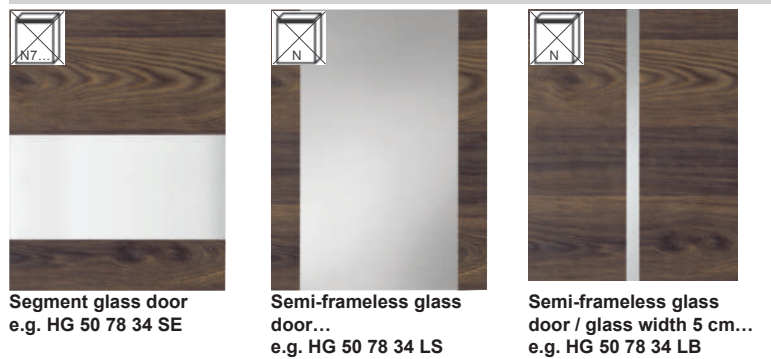


**XL 3801**

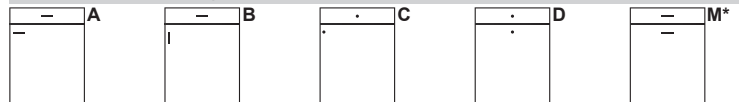
**Front decor** Bordeaux oak effect (rear in same colour)  
**Surface** wood texture  
**Front thickness** 19 mm  
 12,403 kg/sqm excluding handle weight (see handles)  
**Door shape** straight, 4 sides with contoured PP edge, 1.3 mm PUR edge gluing  
**Front material** Multi-layer particle board, coated with melamine resin in multiple-ply design

**Note:**  
 Range always without tightening fitting!

**Available glass doors for specific models**



**Available handle arrangements**



\* = Standard finish

Grip ledges	Handles	cornices / light pelmets
	N 400, N 475, N 485, N 700, N 775 N 900 N 975,	

**Front decor** Burnt Wood effect  
**Surface** wood texture

**XL 3806**

**Note:**  
 Range always without tightening fitting!

**Reference carcass**  
**K075P**  
 Black

**Visible sides**  
**D147S**  
 Burnt Wood effect

**XL** **GL** << 31-119 cm >>



**XL 3310**

- Front decor** Castell oak effect (rear in same colour)
- Surface** wood texture
- Front thickness** 19 mm
- Door shape** 9,567 kg/sqm excluding handle weight (see handles)  
modern coffered front, 4 sides with contoured PP edge 1.3 mm frame width 80 mm
- Front material** multi-layer particle board, coated with melamine resin

**Note:**  
Width 15 cm is supplied with smooth fronts  
**Note:** Widths 20 cm and 25 cm are supplied with smooth fronts

**Available glass doors for specific models**



Framed glass door...  
e.g. HG 50 78 34 RA



**Reference carcase**

**K005S**  
Castell Oak Effect

**Visible sides**

**K005S**  
Castell Oak Effect

**Available glass versions**

90 clear glass	92 matt glass	93 black glass	88 Linea glass

**Available handle arrangements**

A	B	C	D	M*

\* = Standard finish

<b>Grip ledges</b>	<b>Handles</b>	<b>cornices / light pelmets</b>
N 400, N 475, N 485, N 900 N 975, N 700, N 775	M330 M340	



**Front decor** Sherwood oak effect black

**Surface** wood texture



**XL 3344**

**Reference carcass**  
K075P  
Black

**Visible sides**

D176S  
Sherwood Oak Repro. Black

**Front decor** Sherwood oak effect sepia grey

**Surface** wood texture



**XL 3345**

**Reference carcass**  
K075P  
Black

**Visible sides**

D202S  
Sherwood Oak Repro Sepia Grey

**Front decor** Bordeaux oak effect

**Surface** wood texture



**XL 3347**

**Reference carcass**  
K218P  
Light Pepper

**Visible sides**

D224S  
Bordeaux oak effect

**Front decor** Royal Oak effect

**Surface** Synchronised grain structure



**XL 3357**

**Reference carcass**  
K262S  
Royal Oak effect

**Visible sides**

K262S  
Royal Oak effect

**Front decor** Classic Oak effect

**Surface** Synchronised grain structure



**XL 3359**

**Reference carcass**  
K229S  
Classic Oak effect

**Visible sides**

K229S  
Classic Oak effect

**Front decor** Diamond Oak effect

**Surface** wood texture



**XL 3361**

**Reference carcass**  
K236S  
Diamond oak effect

**Visible sides**

K236S  
Diamond oak effect

**Front decor** natural mountain oak effect

**Surface** Synchronised grain structure



**XL 3363**

**Reference carcass**  
K216S  
natural mountain oak effect

**Visible sides**

K216S  
natural mountain oak effect

**Front decor** Piemont oak effect

**Surface** Deepskin



**XL 3368**

**Reference carcass**  
K199S  
Piemont Oak Repro

**Visible sides**

K199S  
Piemont Oak Repro

**Front decor** natural mammoth oak effect

**Surface** wood texture



**XL 3369**

**Reference carcass**  
K190S  
Mammoth oak repro. natural

**Visible sides**

K190S  
Mammoth oak repro. natural

**XL** **GL**



**XL 3625**

- Front decor** Royal Oak effect (rear in same colour)
- Surface** wood texture
- Front thickness** 19 mm
- Door shape** straight, with inset strip, 4 sides with contoured PP edge 1.3 mm, distance between strips 150 mm
- Front material** multi-layer particle board, coated with melamine resin

**NEW**

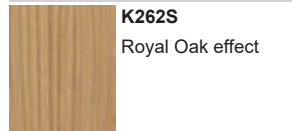
**Note:**  
Please avoid combining different front widths on the same single cabinet type!

**Available glass doors for specific models**



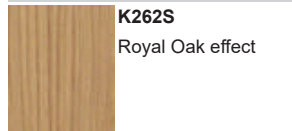
**Semi-frameless glass door...**  
e.g. HG 50 78 34 LS

**Reference carcase**



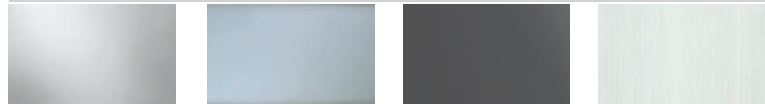
**K262S**  
Royal Oak effect

**Visible sides**



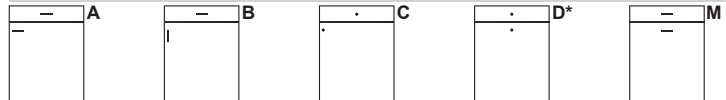
**K262S**  
Royal Oak effect

**Available glass versions**



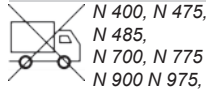
90 clear glass    92 matt glass    93 black glass    88 Linea glass

**Available handle arrangements**



\* = Standard finish

**Grip ledges      Handles      cornices / light pelmets**



~~N 400, N 475,  
N 485,  
N 700, N 775  
N 900 N 975,~~



~~M330 M340~~

XL

GL



**XL 3640**

<b>Front decor</b>	Diamond Oak effect
<b>Surface</b>	wood texture
<b>Front thickness</b>	19 mm
<b>Door shape</b>	12,403 kg/sqm excluding handle weight (see handles) straight, with inset strip, 4 sides with contoured PP edge 1.3 mm, distance between strips 150 mm
<b>Front material</b>	multi-layer particle board, coated with melamine resin

**Note:**  
Please avoid combining different front widths on the same single cabinet type!

**Available glass doors for specific models**



**Semi-frameless glass door...**  
e.g. HG 50 78 34 LS

**Reference carcass**



**K236S**  
Diamond oak effect

**Visible sides**



**K236S**  
Diamond oak effect

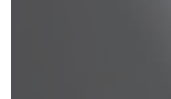
**Available glass versions**



90 clear glass



92 matt glass

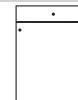
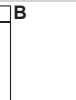
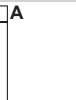


93 black glass



88 Linea glass

**Available handle arrangements**



\* = Standard finish

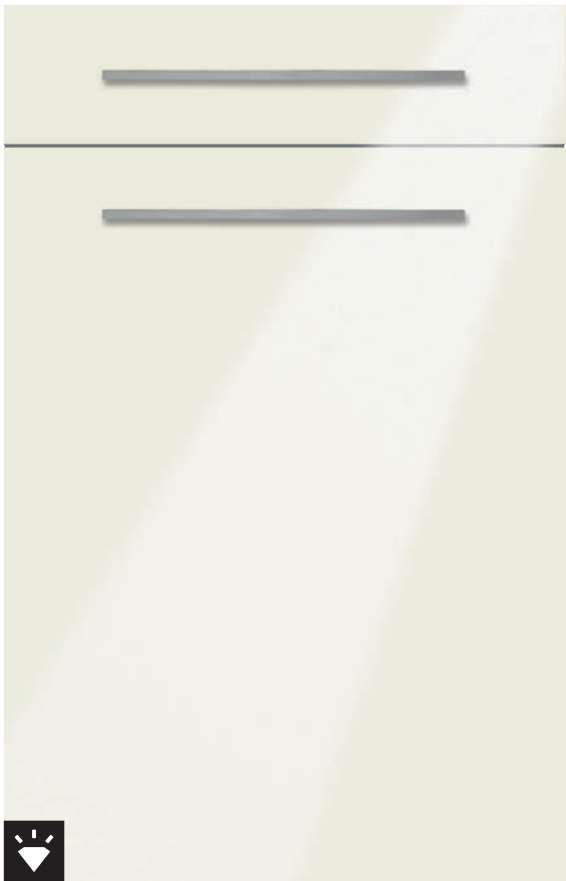
**Grip ledges    Handles    cornices / light pelmets**



N 400, N 475,  
N 485,  
N 700, N 775  
N 900 N 975,



M330  
M340



**XL 3050**

- Front decor** Premium White High Gloss Lacq. (rear in same matt colour)
- Surface** High-gloss lacquer
- Front thickness** 19 mm
- Door shape** 14,729 kg/sqm excluding handle weight (see handles)  
Coffered door, rounded on all sides, radius 3 mm
- Front material** MDF substrate with high-quality lacquered surface

**Limited range of types:**  
Not available in width 70 cm.

**Available glass doors for specific models**



Framed glass door...  
e.g. HG 50 78 34 RA

**Reference carcass**

**K039G**  
Premium white glossy

**Visible sides**

**H039H**  
Premium white

**Available glass versions**

90 clear glass	92 matt glass	93 black glass	88 Linea glass

**Available handle arrangements**

A	B	C	D	M*

\* = Standard finish

<b>Grip ledges</b>	<b>Handles</b>	<b>cornices / light pelmets</b>
	N 400, N 475, N 485, N 900 N 975,	



**XL 3550**

- Front decor** premium white (rear in same colour)
- Surface** Soft lacquer
- Front thickness** 19 mm
- Door shape** 14,669 kg/sqm excluding handle weight (see handles) modern frame front, frame width 80 mm
- Front material** MDF substrate with high-quality lacquered surface

**Note:**  
 Width 15 cm is supplied with smooth fronts  
 Width 20 cm is supplied with smooth fronts  
**Limited range of types:**  
 Not available in width 70 cm.



**Available glass doors for specific models**



Framed glass door...  
 e.g. HG 50 78 34 RA

**Reference carcass**

**K039P**  
 Premium white

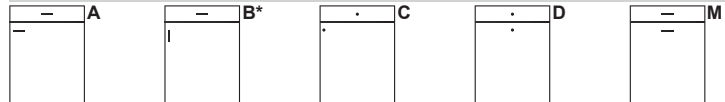
**Visible sides**

**P039M**  
 Premium white

**Available glass versions**

90 clear glass	92 matt glass	93 black glass	88 Linea glass

**Available handle arrangements**

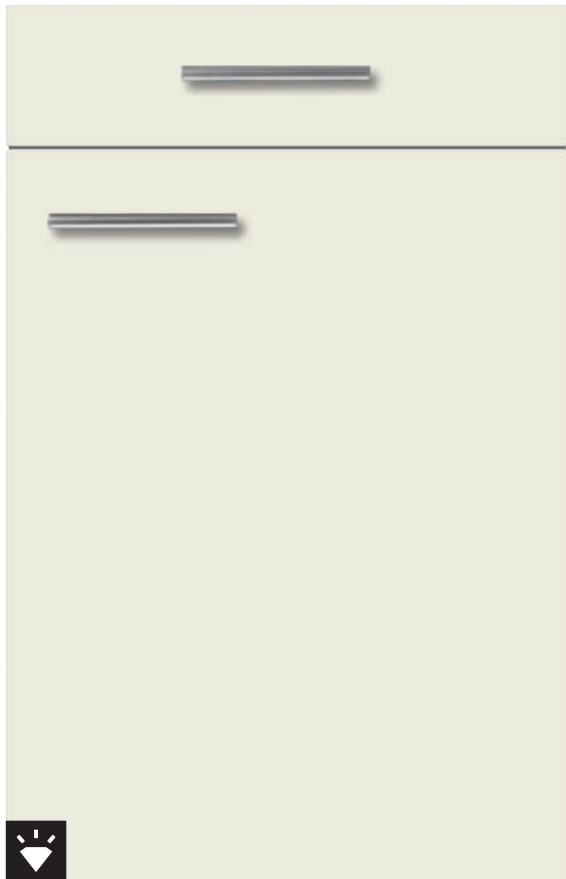


\* = Standard finish

**Grip ledges                      Handles                      cornices / light pelmets**

<del>N 400, N 475, N 485, N 700, N 775, N 900 N 975,</del>	<del>M330 M340</del>	
--	----------------------	--

**XL** **GL** << 31-119 cm >>



**XL 3250**

**Front decor** premium white  
(rear in same colour)  
**Surface** Micro textured lacquer  
**Front thickness** 19 mm  
**Door shape** 14,054 kg/sqm excluding handle weight (see handles)  
Coffered door, rounded on all sides, radius 2 mm  
**Front material** MDF substrate with high-quality lacquered surface

**Available glass doors for specific models**



**Framed glass door...**  
e.g. HG 50 78 34 RA



**Framed glass door...**  
e.g. HGS 50 78 34



**Framed glass door.../ crossbar**  
e.g. HGKS 50 78 34

**Reference carcase**

**K039P**  
Premium white

**Visible sides**

**S039P**  
Premium white

**Available glass versions**



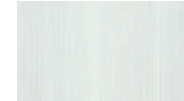
90 clear glass



92 matt glass

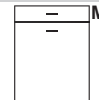
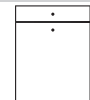
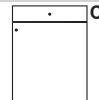
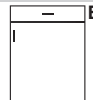
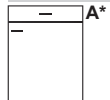


93 black glass



88 Linea glass

**Available handle arrangements**



\* = Standard finish

**Grip ledges**

**Handles**

**cornices / light pelmets**

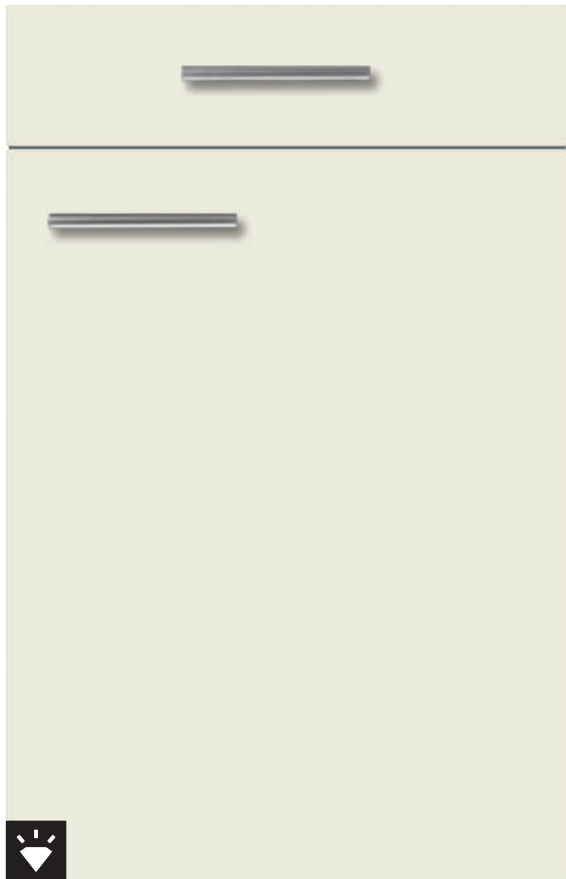


N 400, N 475,  
N 485,  
N 900 N 975,



<p><b>Front decor</b> snow white</p> <p><b>Surface</b> Micro textured lacquer</p>  <p><b>XL 3246</b></p> <p><b>Reference carcass</b> K160F Snow white</p> <p><b>Visible sides</b> S160P Snow White</p>	<p><b>Front decor</b> Light Pepper</p> <p><b>Surface</b> Micro textured lacquer</p>  <p><b>XL 3249</b></p> <p><b>Reference carcass</b> K218P Light Pepper</p> <p><b>Visible sides</b> S218P Light Pepper</p>	<p><b>Front decor</b> White Agate</p> <p><b>Surface</b> Micro textured lacquer</p>  <p><b>XL 3256</b></p> <p><b>Reference carcass</b> K178F White Agate</p> <p><b>Visible sides</b> S178P White Agate</p>								
<p><b>Front decor</b> Night Green</p> <p><b>Surface</b> Micro textured lacquer</p>  <p><b>XL 3259</b></p> <p><b>Reference carcass</b> K075P Black</p> <p><b>Visible sides</b> S245P Night Green</p>	<p><b>Front decor</b> light grey</p> <p><b>Surface</b> Micro textured lacquer</p>  <p><b>XL 3260</b></p> <p><b>Reference carcass</b> K006P Light Grey</p> <p><b>Visible sides</b> S006P Light Grey</p>	<p><b>Front decor</b> Art Pepper</p> <p><b>Surface</b> Micro textured lacquer</p>  <p><b>XL 3261</b></p> <p><b>Reference carcass</b> K230P Art Pepper</p> <p><b>Visible sides</b> S230P Art Pepper</p>								
<p><b>Front decor</b> Macaron</p> <p><b>Surface</b> Micro textured lacquer</p>  <p><b>XL 3265</b></p> <p><b>Reference carcass</b> K076P Macaron</p> <p><b>Visible sides</b> S076P Macaron</p>	<p><b>Front decor</b> Light Nude</p> <p><b>Surface</b> Micro textured lacquer</p>  <p><b>XL 3266</b></p> <p><b>Reference carcass</b> K248P Light Nude</p> <p><b>Visible sides</b> S248P Light Nude</p>	<p><b>Front decor</b> Fango</p> <p><b>Surface</b> Micro textured lacquer</p>  <p><b>XL 3267</b></p> <p><b>Reference carcass</b> K263P Fango</p> <p><b>Visible sides</b> S263P Fango</p>								
<p><b>Front decor</b> magic grey</p> <p><b>Surface</b> Micro textured lacquer</p>  <p><b>XL 3284</b></p> <p><b>Reference carcass</b> K058P Magic-grey</p> <p><b>Visible sides</b> S058P Magic-grey</p>	<p><b>Front decor</b> graphite black</p> <p><b>Surface</b> Micro textured lacquer</p>  <p><b>XL 3295</b></p> <p><b>Reference carcass</b> K043P Graphite Black</p> <p><b>Visible sides</b> S043P Graphite Black</p>	<p><b>Front decor</b> black</p> <p><b>Surface</b> Micro textured lacquer</p>  <p><b>XL 3298</b></p> <p><b>Reference carcass</b> K075P Black</p> <p><b>Visible sides</b> S075P Black</p>								
<p><b>Front decor</b> special colour</p> <p><b>Surface</b> Micro textured lacquer</p>  <p><b>XL 3299</b></p> <p><b>Reference carcass</b> K023P Stainless Steel Colour</p> <p><b>Visible sides</b> S099P special colour</p>	<p style="text-align: center;"><b>Colour concept at no extra charge</b></p> <table border="1"> <tbody> <tr> <td data-bbox="587 1749 826 1839">  <p>Sealbrown RAL 8019</p> </td> <td data-bbox="826 1749 1061 1839">  <p>Cristal red SIKKENS C0.60.30</p> </td> </tr> <tr> <td data-bbox="587 1839 826 1928">  <p>Savona green SIKKENS K0.05.47</p> </td> <td data-bbox="826 1839 1061 1928">  <p>Victoria green RAL 180 30 10</p> </td> </tr> <tr> <td data-bbox="587 1928 826 2018">  <p>Night Red SIKKENS C0.20.20</p> </td> <td data-bbox="826 1928 1061 2018">  <p>Blackblue SIKKENS U0.10.20</p> </td> </tr> <tr> <td data-bbox="587 2018 826 2096">  <p>Jade, pastel RAL 7032</p> <p style="text-align: right;"><small>NEW</small></p> </td> <td data-bbox="826 2018 1061 2096">  <p>live simple! No. 8</p> <p style="text-align: right;"><small>NEW</small></p> </td> </tr> </tbody> </table>		 <p>Sealbrown RAL 8019</p>	 <p>Cristal red SIKKENS C0.60.30</p>	 <p>Savona green SIKKENS K0.05.47</p>	 <p>Victoria green RAL 180 30 10</p>	 <p>Night Red SIKKENS C0.20.20</p>	 <p>Blackblue SIKKENS U0.10.20</p>	 <p>Jade, pastel RAL 7032</p> <p style="text-align: right;"><small>NEW</small></p>	 <p>live simple! No. 8</p> <p style="text-align: right;"><small>NEW</small></p>
 <p>Sealbrown RAL 8019</p>	 <p>Cristal red SIKKENS C0.60.30</p>									
 <p>Savona green SIKKENS K0.05.47</p>	 <p>Victoria green RAL 180 30 10</p>									
 <p>Night Red SIKKENS C0.20.20</p>	 <p>Blackblue SIKKENS U0.10.20</p>									
 <p>Jade, pastel RAL 7032</p> <p style="text-align: right;"><small>NEW</small></p>	 <p>live simple! No. 8</p> <p style="text-align: right;"><small>NEW</small></p>									

**XL** **GL** << 31-119 cm >>



**XL 3382**

- Front decor** premium white (rear in same colour)
- Surface** Velvet lacquer
- Front thickness** 19 mm
- Door shape** 14,054 kg/sqm excluding handle weight (see handles)  
Coffered door, rounded on all sides, radius 2 mm
- Front material** MDF substrate with high-quality lacquered surface

**Available glass doors for specific models**



**Framed glass door...**  
e.g. HG 50 78 34 RA



**Framed glass door...**  
e.g. HGS 50 78 34



**Framed glass door.../ crossbar**  
e.g. HGKS 50 78 34

**Reference carcass**

**K039P**  
Premium white

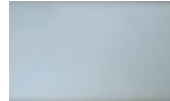
**Visible sides**

**B039F**  
Premium white

**Available glass versions**



90 clear glass



92 matt glass

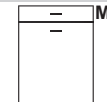
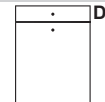
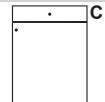
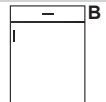
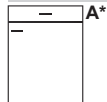


93 black glass



88 Linea glass

**Available handle arrangements**



\* = Standard finish

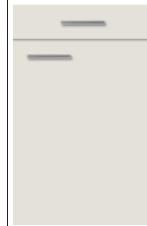



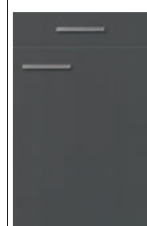
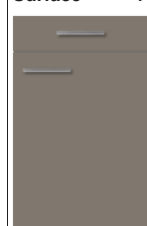

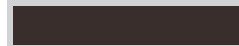
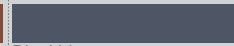

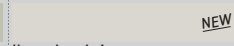
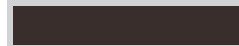
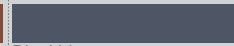

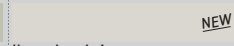
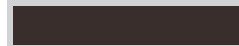
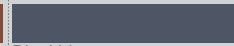

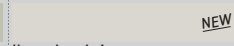
**Grip ledges**

**Handles**

**cornices / light pelmets**



N 400, N 475,  
N 485,  
N 900 N 975,

<p><b>Front decor</b> snow white</p> <p><b>Surface</b> Velvet lacquer</p>  <p><b>XL 3380</b></p> <p><b>Reference carcass</b> K160F Snow white</p> <p><b>Visible sides</b> B160F Snow White</p>	<p><b>Front decor</b> White Agate</p> <p><b>Surface</b> Velvet lacquer</p>  <p><b>XL 3384</b></p> <p><b>Reference carcass</b> K178F White Agate</p> <p><b>Visible sides</b> B178F White Agate</p>	<p><b>Front decor</b> light grey</p> <p><b>Surface</b> Velvet lacquer</p>  <p><b>XL 3385</b></p> <p><b>Reference carcass</b> K006P Light Grey</p> <p><b>Visible sides</b> B006F Light Grey</p>								
<p><b>Front decor</b> Macaron</p> <p><b>Surface</b> Velvet lacquer</p>  <p><b>XL 3386</b></p> <p><b>Reference carcass</b> K076P Macaron</p> <p><b>Visible sides</b> B076F Macaron</p>	<p><b>Front decor</b> Light Pepper</p> <p><b>Surface</b> Velvet lacquer</p>  <p><b>XL 3387</b></p> <p><b>Reference carcass</b> K218P Light Pepper</p> <p><b>Visible sides</b> B218F Light Pepper</p>	<p><b>Front decor</b> magic grey</p> <p><b>Surface</b> Velvet lacquer</p>  <p><b>XL 3388</b></p> <p><b>Reference carcass</b> K058P Magic-grey</p> <p><b>Visible sides</b> B058F Magic-grey</p>								
<p><b>Front decor</b> Night Green</p> <p><b>Surface</b> Velvet lacquer</p>  <p><b>XL 3391</b></p> <p><b>Reference carcass</b> K075P Black</p> <p><b>Visible sides</b> B245F Night Green</p>	<p><b>Front decor</b> Art Pepper</p> <p><b>Surface</b> Velvet lacquer</p>  <p><b>XL 3394</b></p> <p><b>Reference carcass</b> K230P Art Pepper</p> <p><b>Visible sides</b> B230F Art Pepper</p>	<p><b>Front decor</b> graphite black</p> <p><b>Surface</b> Velvet lacquer</p>  <p><b>XL 3395</b></p> <p><b>Reference carcass</b> K043P Graphite Black</p> <p><b>Visible sides</b> B043F Graphite Black</p>								
<p><b>Front decor</b> Light Nude</p> <p><b>Surface</b> Velvet lacquer</p>  <p><b>XL 3396</b></p> <p><b>Reference carcass</b> K248P Light Nude</p> <p><b>Visible sides</b> B248F Light Nude</p>	<p><b>Front decor</b> Fango</p> <p><b>Surface</b> Velvet lacquer</p>  <p><b>XL 3397</b></p> <p><b>Reference carcass</b> K263P Fango</p> <p><b>Visible sides</b> B263F Fango</p>	<p><b>Front decor</b> black</p> <p><b>Surface</b> Velvet lacquer</p>  <p><b>XL 3398</b></p> <p><b>Reference carcass</b> K075P Black</p> <p><b>Visible sides</b> B075F Black</p>								
<p><b>Front decor</b> special colour</p> <p><b>Surface</b> Velvet lacquer</p>  <p><b>XL 3399</b></p> <p><b>Reference carcass</b> K023P Stainless Steel Colour</p> <p><b>Visible sides</b> B099F special colour</p>	<p style="text-align: center;"><b>Colour concept at no extra charge</b></p> <table border="1"> <tbody> <tr> <td data-bbox="587 1749 826 1839">  Sealbrown RAL 8019                 </td> <td data-bbox="826 1749 1061 1839">  Cristal red SIKKENS C0.60.30                 </td> </tr> <tr> <td data-bbox="587 1839 826 1928">  Savona green SIKKENS K0.05.47                 </td> <td data-bbox="826 1839 1061 1928">  Victoria green RAL 180 30 10                 </td> </tr> <tr> <td data-bbox="587 1928 826 2018">  Night Red SIKKENS C0.20.20                 </td> <td data-bbox="826 1928 1061 2018">  Blackblue SIKKENS U0.10.20                 </td> </tr> <tr> <td data-bbox="587 2018 826 2096">  Jade, pastel RAL 7032                 </td> <td data-bbox="826 2018 1061 2096">  live simple! No. 8                 </td> </tr> </tbody> </table>		 Sealbrown RAL 8019	 Cristal red SIKKENS C0.60.30	 Savona green SIKKENS K0.05.47	 Victoria green RAL 180 30 10	 Night Red SIKKENS C0.20.20	 Blackblue SIKKENS U0.10.20	 Jade, pastel RAL 7032	 live simple! No. 8
 Sealbrown RAL 8019	 Cristal red SIKKENS C0.60.30									
 Savona green SIKKENS K0.05.47	 Victoria green RAL 180 30 10									
 Night Red SIKKENS C0.20.20	 Blackblue SIKKENS U0.10.20									
 Jade, pastel RAL 7032	 live simple! No. 8									



**XL 32046**

- Front decor** snow white  
(rear in same colour)
- Surface** Micro textured lacquer
- Front thickness** 19 mm
- Door shape** 14,105 kg/sqm excluding handle weight (see handles)  
modern frame front, frame width 20 mm, approx. 4 mm groove milled on all sides
- Front material** MDF substrate with high-quality lacquered surface

**Available glass doors for specific models**



**Framed glass door...**  
e.g. HG 50 78 34 RA



**Framed glass door...**  
e.g. HGS 50 78 34



**Framed glass door.../ crossbar**  
e.g. HGKS 50 78 34

**Reference carcase**

**K160F**  
Snow white

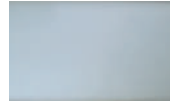
**Visible sides**

**S160P**  
Snow White

**Available glass versions**



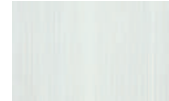
90 clear glass



92 matt glass

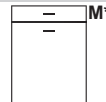
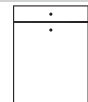
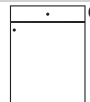
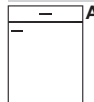


93 black glass



88 Linea glass

**Available handle arrangements**



\* = Standard finish

**Grip ledges**



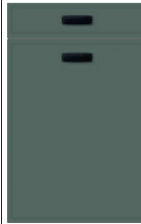
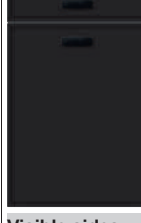
N 400, N 475,  
N 485,  
N 900 N 975,

**Handles**



G 320 G 321  
G 370 G 371  
M330 M340

**cornices / light pelmets**

<p><b>Front decor</b> premium white</p> <p><b>Surface</b> Micro textured lacquer</p>  <p><b>XL 32050</b></p> <p><b>Reference carcass</b> K039P Premium white</p> <p><b>Visible sides</b> S039P Premium white</p>	<p><b>Front decor</b> White Agate</p> <p><b>Surface</b> Micro textured lacquer</p>  <p><b>XL 32056</b></p> <p><b>Reference carcass</b> K178F White Agate</p> <p><b>Visible sides</b> S178P White Agate</p>	<p><b>Front decor</b> Night Green</p> <p><b>Surface</b> Micro textured lacquer</p>  <p><b>XL 32059</b></p> <p><b>Reference carcass</b> K075P Black</p> <p><b>Visible sides</b> S245P Night Green</p>								
<p><b>Front decor</b> light grey</p> <p><b>Surface</b> Micro textured lacquer</p>  <p><b>XL 32060</b></p> <p><b>Reference carcass</b> K006P Light Grey</p> <p><b>Visible sides</b> S006P Light Grey</p>	<p><b>Front decor</b> Art Pepper</p> <p><b>Surface</b> Micro textured lacquer</p>  <p><b>XL 32062</b></p> <p><b>Reference carcass</b> K230P Art Pepper</p> <p><b>Visible sides</b> S230P Art Pepper</p>	<p><b>Front decor</b> Macaron</p> <p><b>Surface</b> Micro textured lacquer</p>  <p><b>XL 32065</b></p> <p><b>Reference carcass</b> K076P Macaron</p> <p><b>Visible sides</b> S076P Macaron</p>								
<p><b>Front decor</b> Light Nude</p> <p><b>Surface</b> Micro textured lacquer</p>  <p><b>XL 32066</b></p> <p><b>Reference carcass</b> K248P Light Nude</p> <p><b>Visible sides</b> S248P Light Nude</p>	<p><b>Front decor</b> Fango</p> <p><b>Surface</b> Micro textured lacquer</p>  <p><b>XL 32067</b></p> <p><b>Reference carcass</b> K263P Fango</p> <p><b>Visible sides</b> S263P Fango</p>	<p><b>Front decor</b> Light Pepper</p> <p><b>Surface</b> Micro textured lacquer</p>  <p><b>XL 32069</b></p> <p><b>Reference carcass</b> K218P Light Pepper</p> <p><b>Visible sides</b> S218P Light Pepper</p>								
<p><b>Front decor</b> magic grey</p> <p><b>Surface</b> Micro textured lacquer</p>  <p><b>XL 32084</b></p> <p><b>Reference carcass</b> K058P Magic-grey</p> <p><b>Visible sides</b> S058P Magic-grey</p>	<p><b>Front decor</b> graphite black</p> <p><b>Surface</b> Micro textured lacquer</p>  <p><b>XL 32095</b></p> <p><b>Reference carcass</b> K043P Graphite Black</p> <p><b>Visible sides</b> S043P Graphite Black</p>	<p><b>Front decor</b> black</p> <p><b>Surface</b> Micro textured lacquer</p>  <p><b>XL 32098</b></p> <p><b>Reference carcass</b> K075P Black</p> <p><b>Visible sides</b> S075P Black</p>								
<p><b>Front decor</b> special colour</p> <p><b>Surface</b> Micro textured lacquer</p>  <p><b>XL 32099</b></p> <p><b>Reference carcass</b> K023P Stainless Steel Colour</p> <p><b>Visible sides</b> S099P special colour</p>	<p style="text-align: center;"><b>Colour concept at no extra charge</b></p> <table border="1"> <tbody> <tr> <td data-bbox="596 1753 831 1839">  Sealbrown RAL 8019                 </td> <td data-bbox="836 1753 1064 1839">  Cristal red SIKKENS C0.60.30                 </td> </tr> <tr> <td data-bbox="596 1845 831 1930">  Savona green SIKKENS K0.05.47                 </td> <td data-bbox="836 1845 1064 1930">  Victoria green RAL 180 30 10                 </td> </tr> <tr> <td data-bbox="596 1937 831 2022">  Night Red SIKKENS C0.20.20                 </td> <td data-bbox="836 1937 1064 2022">  Blackblue SIKKENS U0.10.20                 </td> </tr> <tr> <td data-bbox="596 2029 831 2096">  Jade, pastel RAL 7032                 </td> <td data-bbox="836 2029 1064 2096">  live simple! No. 8                 </td> </tr> </tbody> </table>		 Sealbrown RAL 8019	 Cristal red SIKKENS C0.60.30	 Savona green SIKKENS K0.05.47	 Victoria green RAL 180 30 10	 Night Red SIKKENS C0.20.20	 Blackblue SIKKENS U0.10.20	 Jade, pastel RAL 7032	 live simple! No. 8
 Sealbrown RAL 8019	 Cristal red SIKKENS C0.60.30									
 Savona green SIKKENS K0.05.47	 Victoria green RAL 180 30 10									
 Night Red SIKKENS C0.20.20	 Blackblue SIKKENS U0.10.20									
 Jade, pastel RAL 7032	 live simple! No. 8									



**XL 34046**

- Front decor** snow white  
(rear in same colour)
- Surface** Velvet lacquer
- Front thickness** 19 mm
- Door shape** 14,105 kg/sqm excluding handle weight (see handles)  
modern frame front, frame width 20 mm, approx. 4 mm groove milled on all sides
- Front material** MDF substrate with high-quality lacquered surface

**Available glass doors for specific models**



**Framed glass door...**  
e.g. HG 50 78 34 RA



**Framed glass door...**  
e.g. HGS 50 78 34



**Framed glass door.../ crossbar**  
e.g. HGKS 50 78 34

**Reference carcass**

**K160F**  
Snow white

**Visible sides**

**B160F**  
Snow White

**Available glass versions**



90 clear glass



92 matt glass

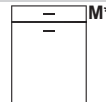
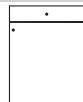
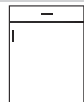
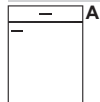


93 black glass



88 Linea glass

**Available handle arrangements**



\* = Standard finish

**Grip ledges**



N 400, N 475,  
N 485,  
N 900 N 975,










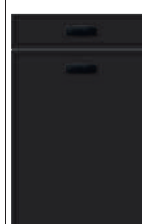

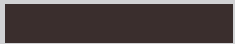

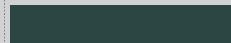



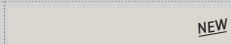
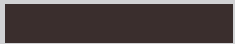

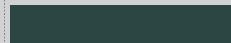



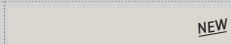
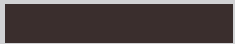

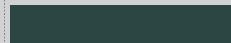



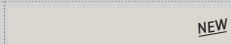
**Handles**

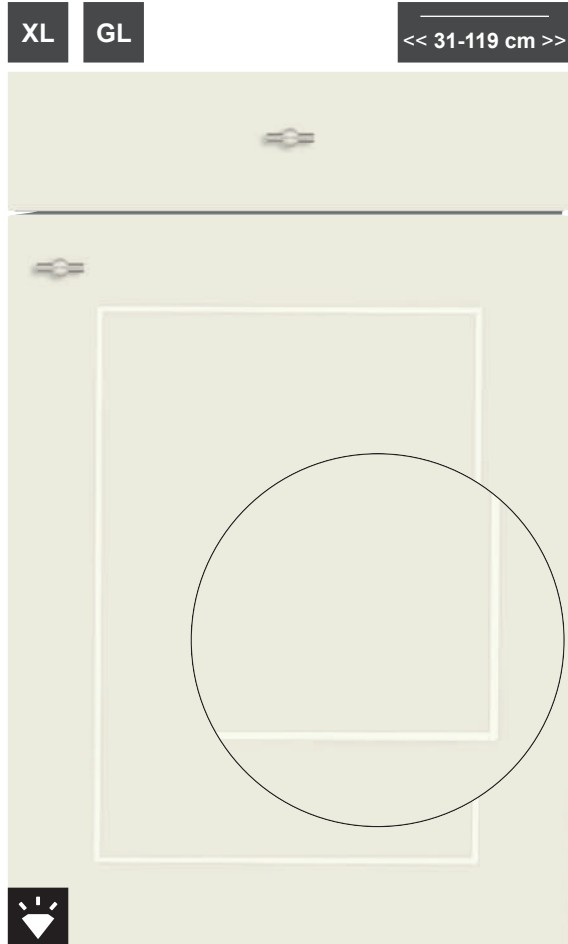


G 320 G 321  
G 370 G 371  
M330 M340

**cornices / light pelmets**



<p><b>Front decor</b> premium white</p> <p><b>Surface</b> Velvet lacquer</p>  <p><b>XL 34050</b></p> <p><b>Reference carcass</b> K039P Premium white</p> <p><b>Visible sides</b> B039F Premium white</p>	<p><b>Front decor</b> White Agate</p> <p><b>Surface</b> Velvet lacquer</p>  <p><b>XL 34056</b></p> <p><b>Reference carcass</b> K178F White Agate</p> <p><b>Visible sides</b> B178F White Agate</p>	<p><b>Front decor</b> Night Green</p> <p><b>Surface</b> Velvet lacquer</p>  <p><b>XL 34059</b></p> <p><b>Reference carcass</b> K075P Black</p> <p><b>Visible sides</b> B245F Night Green</p>								
<p><b>Front decor</b> light grey</p> <p><b>Surface</b> Velvet lacquer</p>  <p><b>XL 34060</b></p> <p><b>Reference carcass</b> K006P Light Grey</p> <p><b>Visible sides</b> B006F Light Grey</p>	<p><b>Front decor</b> Art Pepper</p> <p><b>Surface</b> Velvet lacquer</p>  <p><b>XL 34062</b></p> <p><b>Reference carcass</b> K230P Art Pepper</p> <p><b>Visible sides</b> B230F Art Pepper</p>	<p><b>Front decor</b> Macaron</p> <p><b>Surface</b> Velvet lacquer</p>  <p><b>XL 34065</b></p> <p><b>Reference carcass</b> K076P Macaron</p> <p><b>Visible sides</b> B076F Macaron</p>								
<p><b>Front decor</b> Light Nude</p> <p><b>Surface</b> Velvet lacquer</p>  <p><b>XL 34066</b></p> <p><b>Reference carcass</b> K248P Light Nude</p> <p><b>Visible sides</b> B248F Light Nude</p>	<p><b>Front decor</b> Fango</p> <p><b>Surface</b> Velvet lacquer</p>  <p><b>XL 34067</b></p> <p><b>Reference carcass</b> K263P Fango</p> <p><b>Visible sides</b> B263F Fango</p>	<p><b>Front decor</b> Light Pepper</p> <p><b>Surface</b> Velvet lacquer</p>  <p><b>XL 34069</b></p> <p><b>Reference carcass</b> K218P Light Pepper</p> <p><b>Visible sides</b> B218F Light Pepper</p>								
<p><b>Front decor</b> magic grey</p> <p><b>Surface</b> Velvet lacquer</p>  <p><b>XL 34084</b></p> <p><b>Reference carcass</b> K058P Magic-grey</p> <p><b>Visible sides</b> B058F Magic-grey</p>	<p><b>Front decor</b> graphite black</p> <p><b>Surface</b> Velvet lacquer</p>  <p><b>XL 34095</b></p> <p><b>Reference carcass</b> K043P Graphite Black</p> <p><b>Visible sides</b> B043F Graphite Black</p>	<p><b>Front decor</b> black</p> <p><b>Surface</b> Velvet lacquer</p>  <p><b>XL 34098</b></p> <p><b>Reference carcass</b> K075P Black</p> <p><b>Visible sides</b> B075F Black</p>								
<p><b>Front decor</b> special colour</p> <p><b>Surface</b> Velvet lacquer</p>  <p><b>XL 34099</b></p> <p><b>Reference carcass</b> K023P Stainless Steel Colour</p> <p><b>Visible sides</b> B099F special colour</p>	<p style="text-align: center;"><b>Colour concept at no extra charge</b></p> <table border="1"> <tbody> <tr> <td data-bbox="595 1751 831 1839">  Sealbrown RAL 8019                 </td> <td data-bbox="831 1751 1062 1839">  Cristal red SIKKENS C0.60.30                 </td> </tr> <tr> <td data-bbox="595 1839 831 1926">  Savona green SIKKENS K0.05.47                 </td> <td data-bbox="831 1839 1062 1926">  Victoria green RAL 180 30 10                 </td> </tr> <tr> <td data-bbox="595 1926 831 2013">  Night Red SIKKENS C0.20.20                 </td> <td data-bbox="831 1926 1062 2013">  Blackblue SIKKENS U0.10.20                 </td> </tr> <tr> <td data-bbox="595 2013 831 2096">  Jade, pastel RAL 7032                 </td> <td data-bbox="831 2013 1062 2096">  live simple! No. 8                 </td> </tr> </tbody> </table>		 Sealbrown RAL 8019	 Cristal red SIKKENS C0.60.30	 Savona green SIKKENS K0.05.47	 Victoria green RAL 180 30 10	 Night Red SIKKENS C0.20.20	 Blackblue SIKKENS U0.10.20	 Jade, pastel RAL 7032	 live simple! No. 8
 Sealbrown RAL 8019	 Cristal red SIKKENS C0.60.30									
 Savona green SIKKENS K0.05.47	 Victoria green RAL 180 30 10									
 Night Red SIKKENS C0.20.20	 Blackblue SIKKENS U0.10.20									
 Jade, pastel RAL 7032	 live simple! No. 8									



**XL 3720**

- Front decor** premium white (rear in same colour)
- Surface** Micro textured lacquer
- Front thickness** 19 mm
- Door shape** 14,054 kg/sqm excluding handle weight (see handles)  
Coffered door, rounded on all sides, radius 2 mm, with 80 mm frame moulding
- Front material** MDF substrate with high-quality lacquered surface

**Note:**  
Width 15 cm is supplied with smooth fronts

**Available glass doors for specific models**



**Framed glass door...**  
e.g. HG 50 78 34 RA



**Framed glass door...**  
e.g. HGS 50 78 34



**Framed glass door.../ crossbar**  
e.g. HGKS 50 78 34

**Reference carcass**  
K039P  
Premium white

**Visible sides**  
S039P  
Premium white

**Available glass versions**






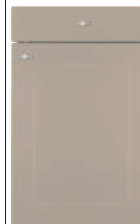
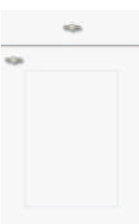
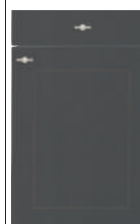


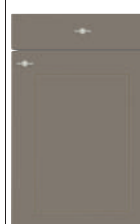

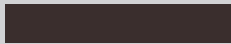

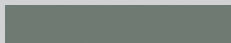
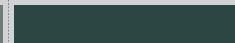


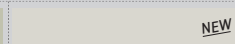
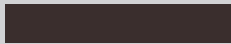

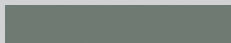
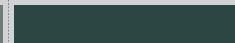


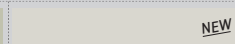
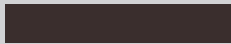

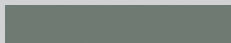
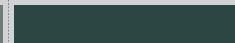


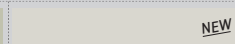
90 clear glass	92 matt glass	93 black glass	88 Linea glass

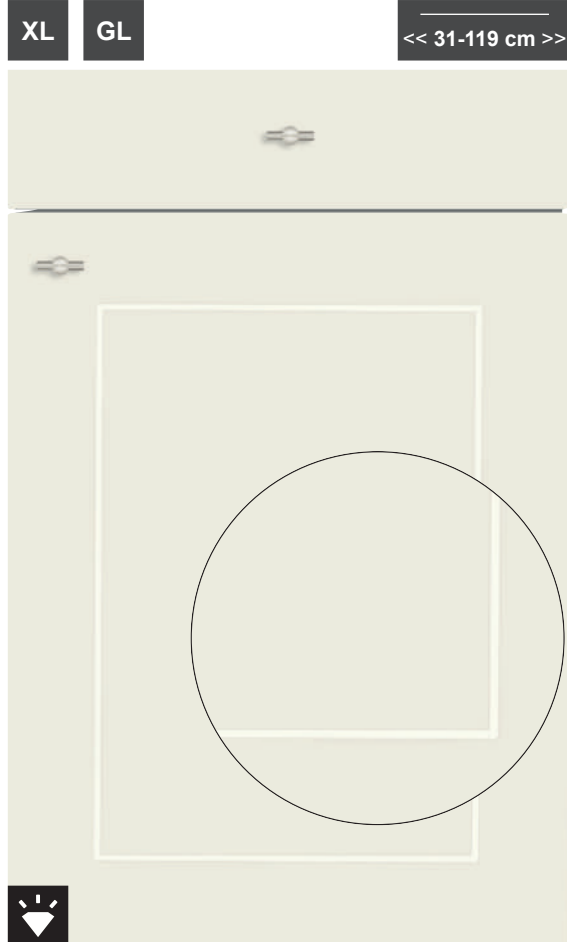
**Available handle arrangements**

A	B	C*	D	M

\* = Standard finish

<b>Grip ledges</b>	<b>Handles</b>	<b>cornices / light pelmets</b>
N 400, N 475, N 485, N 900 N 975,	M330 M340	

<p><b>Front decor</b> light grey</p> <p><b>Surface</b> Micro textured lacquer</p>  <p><b>XL 3722</b></p> <p><b>Reference carcass</b> K006P Light Grey</p> <p><b>Visible sides</b> S006P Light Grey</p>	<p><b>Front decor</b> Macaron</p> <p><b>Surface</b> Micro textured lacquer</p>  <p><b>XL 3724</b></p> <p><b>Reference carcass</b> K076P Macaron</p> <p><b>Visible sides</b> S076P Macaron</p>	<p><b>Front decor</b> Light Pepper</p> <p><b>Surface</b> Micro textured lacquer</p>  <p><b>XL 3729</b></p> <p><b>Reference carcass</b> K218P Light Pepper</p> <p><b>Visible sides</b> S218P Light Pepper</p>								
<p><b>Front decor</b> graphite black</p> <p><b>Surface</b> Micro textured lacquer</p>  <p><b>XL 3732</b></p> <p><b>Reference carcass</b> K043P Graphite Black</p> <p><b>Visible sides</b> S043P Graphite Black</p>	<p><b>Front decor</b> black</p> <p><b>Surface</b> Micro textured lacquer</p>  <p><b>XL 3734</b></p> <p><b>Reference carcass</b> K075P Black</p> <p><b>Visible sides</b> S075P Black</p>	<p><b>Front decor</b> magic grey</p> <p><b>Surface</b> Micro textured lacquer</p>  <p><b>XL 3738</b></p> <p><b>Reference carcass</b> K058P Magic-grey</p> <p><b>Visible sides</b> S058P Magic-grey</p>								
<p><b>Front decor</b> snow white</p> <p><b>Surface</b> Micro textured lacquer</p>  <p><b>XL 3746</b></p> <p><b>Reference carcass</b> K160F Snow white</p> <p><b>Visible sides</b> S160P Snow White</p>	<p><b>Front decor</b> White Agate</p> <p><b>Surface</b> Micro textured lacquer</p>  <p><b>XL 3756</b></p> <p><b>Reference carcass</b> K178F White Agate</p> <p><b>Visible sides</b> S178P White Agate</p>	<p><b>Front decor</b> Art Pepper</p> <p><b>Surface</b> Micro textured lacquer</p>  <p><b>XL 3758</b></p> <p><b>Reference carcass</b> K230P Art Pepper</p> <p><b>Visible sides</b> S230P Art Pepper</p>								
<p><b>Front decor</b> Night Green</p> <p><b>Surface</b> Micro textured lacquer</p>  <p><b>XL 3759</b></p> <p><b>Reference carcass</b> K075P Black</p> <p><b>Visible sides</b> S245P Night Green</p>	<p><b>Front decor</b> Light Nude</p> <p><b>Surface</b> Micro textured lacquer</p>  <p><b>XL 3766</b></p> <p><b>Reference carcass</b> K248P Light Nude</p> <p><b>Visible sides</b> S248P Light Nude</p>	<p><b>Front decor</b> Fango</p> <p><b>Surface</b> Micro textured lacquer</p>  <p><b>XL 3767</b></p> <p><b>Reference carcass</b> K263P Fango</p> <p><b>Visible sides</b> S263P Fango</p>								
<p><b>Front decor</b> special colour</p> <p><b>Surface</b> Micro textured lacquer</p>  <p><b>XL 3749</b></p> <p><b>Reference carcass</b> K023P Stainless Steel Colour</p> <p><b>Visible sides</b> S099P special colour</p>	<p style="text-align: center;"><b>Colour concept at no extra charge</b></p> <table border="1"> <tbody> <tr> <td data-bbox="595 1751 826 1839">  Sealbrown RAL 8019                 </td> <td data-bbox="826 1751 1062 1839">  Cristal red SIKKENS C0.60.30                 </td> </tr> <tr> <td data-bbox="595 1839 826 1926">  Savona green SIKKENS K0.05.47                 </td> <td data-bbox="826 1839 1062 1926">  Victoria green RAL 180 30 10                 </td> </tr> <tr> <td data-bbox="595 1926 826 2013">  Night Red SIKKENS C0.20.20                 </td> <td data-bbox="826 1926 1062 2013">  Blackblue SIKKENS U0.10.20                 </td> </tr> <tr> <td data-bbox="595 2013 826 2096">  Jade, pastel RAL 7032                 </td> <td data-bbox="826 2013 1062 2096">  live simple! No. 8                 </td> </tr> </tbody> </table>		 Sealbrown RAL 8019	 Cristal red SIKKENS C0.60.30	 Savona green SIKKENS K0.05.47	 Victoria green RAL 180 30 10	 Night Red SIKKENS C0.20.20	 Blackblue SIKKENS U0.10.20	 Jade, pastel RAL 7032	 live simple! No. 8
 Sealbrown RAL 8019	 Cristal red SIKKENS C0.60.30									
 Savona green SIKKENS K0.05.47	 Victoria green RAL 180 30 10									
 Night Red SIKKENS C0.20.20	 Blackblue SIKKENS U0.10.20									
 Jade, pastel RAL 7032	 live simple! No. 8									



**XL 3782**

- Front decor** premium white (rear in same colour)
- Surface** Velvet lacquer
- Front thickness** 19 mm
- Door shape** 14,054 kg/sqm excluding handle weight (see handles)  
Coffered door, rounded on all sides, radius 2 mm, with 80 mm frame moulding
- Front material** MDF substrate with high-quality lacquered surface

**Note:**  
Width 15 cm is supplied with smooth fronts

**Available glass doors for specific models**



**Framed glass door...**  
e.g. HG 50 78 34 RA



**Framed glass door...**  
e.g. HGS 50 78 34



**Framed glass door.../ crossbar**  
e.g. HGKS 50 78 34

**Reference carcass**

**K039P**  
Premium white

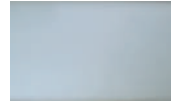
**Visible sides**

**B039F**  
Premium white

**Available glass versions**



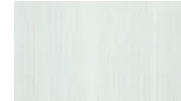
90 clear glass



92 matt glass

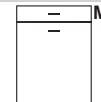
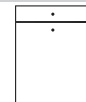
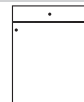


93 black glass



88 Linea glass

**Available handle arrangements**



\* = Standard finish

**Grip ledges**



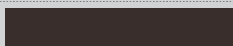
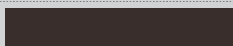
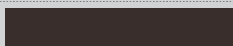
N 400, N 475,  
N 485,  
N 900 N 975,

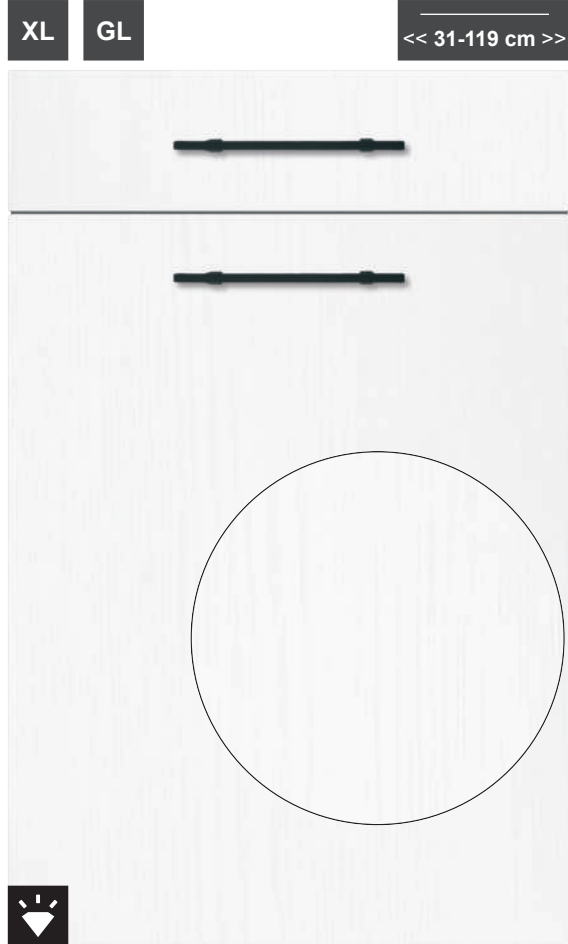
**Handles**



M330 M340

**cornices / light pelmets**

<p><b>Front decor</b> snow white</p> <p><b>Surface</b> Velvet lacquer</p>  <p><b>XL 3780</b></p> <p><b>Reference carcass</b> K160F Snow white</p> <p><b>Visible sides</b> B160F Snow White</p>	<p><b>Front decor</b> White Agate</p> <p><b>Surface</b> Velvet lacquer</p>  <p><b>XL 3784</b></p> <p><b>Reference carcass</b> K178F White Agate</p> <p><b>Visible sides</b> B178F White Agate</p>	<p><b>Front decor</b> light grey</p> <p><b>Surface</b> Velvet lacquer</p>  <p><b>XL 3785</b></p> <p><b>Reference carcass</b> K006P Light Grey</p> <p><b>Visible sides</b> B006F Light Grey</p>								
<p><b>Front decor</b> Macaron</p> <p><b>Surface</b> Velvet lacquer</p>  <p><b>XL 3786</b></p> <p><b>Reference carcass</b> K076P Macaron</p> <p><b>Visible sides</b> B076F Macaron</p>	<p><b>Front decor</b> Light Pepper</p> <p><b>Surface</b> Velvet lacquer</p>  <p><b>XL 3787</b></p> <p><b>Reference carcass</b> K218P Light Pepper</p> <p><b>Visible sides</b> B218F Light Pepper</p>	<p><b>Front decor</b> magic grey</p> <p><b>Surface</b> Velvet lacquer</p>  <p><b>XL 3788</b></p> <p><b>Reference carcass</b> K058P Magic-grey</p> <p><b>Visible sides</b> B058F Magic-grey</p>								
<p><b>Front decor</b> Art Pepper</p> <p><b>Surface</b> Velvet lacquer</p>  <p><b>XL 3791</b></p> <p><b>Reference carcass</b> K230P Art Pepper</p> <p><b>Visible sides</b> B230F Art Pepper</p>	<p><b>Front decor</b> Night Green</p> <p><b>Surface</b> Velvet lacquer</p>  <p><b>XL 3793</b></p> <p><b>Reference carcass</b> K075P Black</p> <p><b>Visible sides</b> B245F Night Green</p>	<p><b>Front decor</b> graphite black</p> <p><b>Surface</b> Velvet lacquer</p>  <p><b>XL 3795</b></p> <p><b>Reference carcass</b> K043P Graphite Black</p> <p><b>Visible sides</b> B043F Graphite Black</p>								
<p><b>Front decor</b> Light Nude</p> <p><b>Surface</b> Velvet lacquer</p>  <p><b>XL 3796</b></p> <p><b>Reference carcass</b> K248P Light Nude</p> <p><b>Visible sides</b> B248F Light Nude</p>	<p><b>Front decor</b> Fango</p> <p><b>Surface</b> Velvet lacquer</p>  <p><b>XL 3797</b></p> <p><b>Reference carcass</b> K263P Fango</p> <p><b>Visible sides</b> B263F Fango</p>	<p><b>Front decor</b> black</p> <p><b>Surface</b> Velvet lacquer</p>  <p><b>XL 3798</b></p> <p><b>Reference carcass</b> K075P Black</p> <p><b>Visible sides</b> B075F Black</p>								
<p><b>Front decor</b> special colour</p> <p><b>Surface</b> Velvet lacquer</p>  <p><b>XL 3799</b></p> <p><b>Reference carcass</b> K023P Stainless Steel Colour</p> <p><b>Visible sides</b> B099F special colour</p>	<p style="text-align: center;"><b>Colour concept at no extra charge</b></p> <table border="1"> <tbody> <tr> <td data-bbox="595 1747 829 1836">  Sealbrown RAL 8019                 </td> <td data-bbox="829 1747 1062 1836">  Cristal red SIKKENS C0.60.30                 </td> </tr> <tr> <td data-bbox="595 1836 829 1926">  Savona green SIKKENS K0.05.47                 </td> <td data-bbox="829 1836 1062 1926">  Victoria green RAL 180 30 10                 </td> </tr> <tr> <td data-bbox="595 1926 829 2016">  Night Red SIKKENS C0.20.20                 </td> <td data-bbox="829 1926 1062 2016">  Blackblue SIKKENS U0.10.20                 </td> </tr> <tr> <td data-bbox="595 2016 829 2096">  Jade, pastel RAL 7032                 </td> <td data-bbox="829 2016 1062 2096">  live simple! No. 8                 </td> </tr> </tbody> </table>		 Sealbrown RAL 8019	 Cristal red SIKKENS C0.60.30	 Savona green SIKKENS K0.05.47	 Victoria green RAL 180 30 10	 Night Red SIKKENS C0.20.20	 Blackblue SIKKENS U0.10.20	 Jade, pastel RAL 7032	 live simple! No. 8
 Sealbrown RAL 8019	 Cristal red SIKKENS C0.60.30									
 Savona green SIKKENS K0.05.47	 Victoria green RAL 180 30 10									
 Night Red SIKKENS C0.20.20	 Blackblue SIKKENS U0.10.20									
 Jade, pastel RAL 7032	 live simple! No. 8									



**XL 31046**

- Front decor** snow white  
(rear in same colour)
- Surface** velvet lacquer with wood texture
- Front thickness** 19 mm
- Door shape** 14,054 kg/sqm excluding handle weight (see handles)  
Coffered door, rounded on all sides, radius 2 mm
- Front material** MDF substrate with high-quality lacquered surface

**Available glass doors for specific models**



**Framed glass door...**  
e.g. HG 50 78 34 RA

**Reference carcase**

**K160F**  
Snow white

**Visible sides**

**R160H**  
Snow White

**Available glass versions**



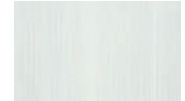
90 clear glass



92 matt glass

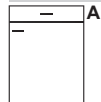


93 black glass



88 Linea glass

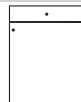
**Available handle arrangements**



**A**



**B**



**C**



**D**



**M\***

\* = Standard finish

**Grip ledges**


**Handles**

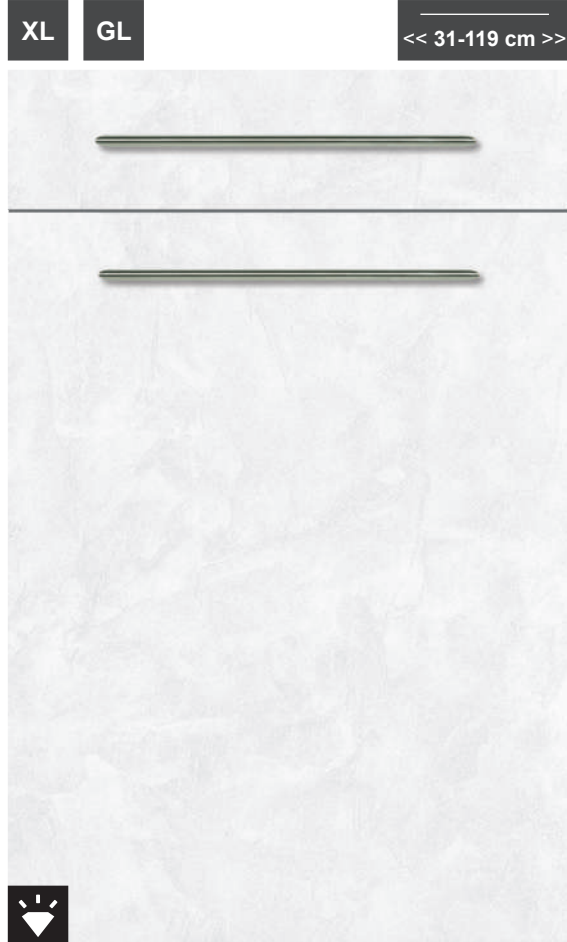
**cornices / light pelmets**



N 400, N 475,  
N 485,  
N 900 N 975,



<p><b>Front decor</b> premium white</p> <p><b>Surface</b> velvet lacquer with wood texture</p>  <p><b>XL 31050</b></p> <p><b>Reference carcass</b> K039P Premium white</p> <p><b>Visible sides</b> R039H Premium white</p>	<p><b>Front decor</b> White Agate</p> <p><b>Surface</b> velvet lacquer with wood texture</p>  <p><b>XL 31056</b></p> <p><b>Reference carcass</b> K178F White Agate</p> <p><b>Visible sides</b> R178H White Agate</p>	<p><b>Front decor</b> Night Green</p> <p><b>Surface</b> velvet lacquer with wood texture</p>  <p><b>XL 31059</b></p> <p><b>Reference carcass</b> K075P Black</p> <p><b>Visible sides</b> R245H Night Green</p>								
<p><b>Front decor</b> light grey</p> <p><b>Surface</b> velvet lacquer with wood texture</p>  <p><b>XL 31060</b></p> <p><b>Reference carcass</b> K006P Light Grey</p> <p><b>Visible sides</b> R006H Light Grey</p>	<p><b>Front decor</b> Art Pepper</p> <p><b>Surface</b> velvet lacquer with wood texture</p>  <p><b>XL 31062</b></p> <p><b>Reference carcass</b> K230P Art Pepper</p> <p><b>Visible sides</b> R230H Art Pepper</p>	<p><b>Front decor</b> Macaron</p> <p><b>Surface</b> velvet lacquer with wood texture</p>  <p><b>XL 31065</b></p> <p><b>Reference carcass</b> K076P Macaron</p> <p><b>Visible sides</b> R076H Macaron</p>								
<p><b>Front decor</b> Light Nude</p> <p><b>Surface</b> velvet lacquer with wood texture</p>  <p><b>XL 31066</b></p> <p><b>Reference carcass</b> K248P Light Nude</p> <p><b>Visible sides</b> R248H Light Nude</p>	<p><b>Front decor</b> Fango</p> <p><b>Surface</b> velvet lacquer with wood texture</p>  <p><b>XL 31067</b></p> <p><b>Reference carcass</b> K263P Fango</p> <p><b>Visible sides</b> R263H Fango</p>	<p><b>Front decor</b> Light Pepper</p> <p><b>Surface</b> velvet lacquer with wood texture</p>  <p><b>XL 31069</b></p> <p><b>Reference carcass</b> K218P Light Pepper</p> <p><b>Visible sides</b> R218H Light Pepper</p>								
<p><b>Front decor</b> magic grey</p> <p><b>Surface</b> velvet lacquer with wood texture</p>  <p><b>XL 31084</b></p> <p><b>Reference carcass</b> K058P Magic-grey</p> <p><b>Visible sides</b> R058H Magic-grey</p>	<p><b>Front decor</b> graphite black</p> <p><b>Surface</b> velvet lacquer with wood texture</p>  <p><b>XL 31095</b></p> <p><b>Reference carcass</b> K043P Graphite Black</p> <p><b>Visible sides</b> R043H Graphite Black</p>	<p><b>Front decor</b> black</p> <p><b>Surface</b> velvet lacquer with wood texture</p>  <p><b>XL 31098</b></p> <p><b>Reference carcass</b> K075P Black</p> <p><b>Visible sides</b> R075H Black</p>								
<p><b>Front decor</b> special colour</p> <p><b>Surface</b> velvet lacquer with wood texture</p>  <p><b>XL 31099</b></p> <p><b>Reference carcass</b> K023P Stainless Steel Colour</p> <p><b>Visible sides</b> R099H special colour</p>	<p style="text-align: center;"><b>Colour concept at no extra charge</b></p> <table border="1"> <tbody> <tr> <td data-bbox="596 1758 829 1839">  Sealbrown RAL 8019                 </td> <td data-bbox="834 1758 1067 1839">  Cristal red SIKKENS C0.60.30                 </td> </tr> <tr> <td data-bbox="596 1845 829 1926">  Savona green SIKKENS K0.05.47                 </td> <td data-bbox="834 1845 1067 1926">  Victoria green RAL 180 30 10                 </td> </tr> <tr> <td data-bbox="596 1933 829 2013">  Night Red SIKKENS C0.20.20                 </td> <td data-bbox="834 1933 1067 2013">  Blackblue SIKKENS U0.10.20                 </td> </tr> <tr> <td data-bbox="596 2020 829 2101">  Jade, pastel RAL 7032                 </td> <td data-bbox="834 2020 1067 2101">  live simple! No. 8                 </td> </tr> </tbody> </table>		 Sealbrown RAL 8019	 Cristal red SIKKENS C0.60.30	 Savona green SIKKENS K0.05.47	 Victoria green RAL 180 30 10	 Night Red SIKKENS C0.20.20	 Blackblue SIKKENS U0.10.20	 Jade, pastel RAL 7032	 live simple! No. 8
 Sealbrown RAL 8019	 Cristal red SIKKENS C0.60.30									
 Savona green SIKKENS K0.05.47	 Victoria green RAL 180 30 10									
 Night Red SIKKENS C0.20.20	 Blackblue SIKKENS U0.10.20									
 Jade, pastel RAL 7032	 live simple! No. 8									



**XL 30046**

**Front decor** snow white  
(rear in same colour)  
**Surface** Velvet lacquer putty effect  
**Front thickness** 19 mm  
**Door shape** 14,054 kg/sqm excluding handle weight (see handles)  
 Coffered door, rounded on all sides, radius 2 mm  
**Front material** MDF substrate with high-quality lacquered surface

**Available glass doors for specific models**



**Framed glass door...**  
e.g. HG 50 78 34 RA

**Reference carcase**

**K160F**  
Snow white

**Visible sides**

**R160W**  
Snow White

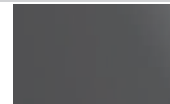
**Available glass versions**



90 clear glass



92 matt glass



93 black glass



88 Linea glass

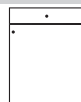
**Available handle arrangements**



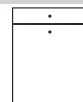
**A**



**B**



**C**



**D**



**M\***

\* = Standard finish

**Grip ledges**

**Handles**

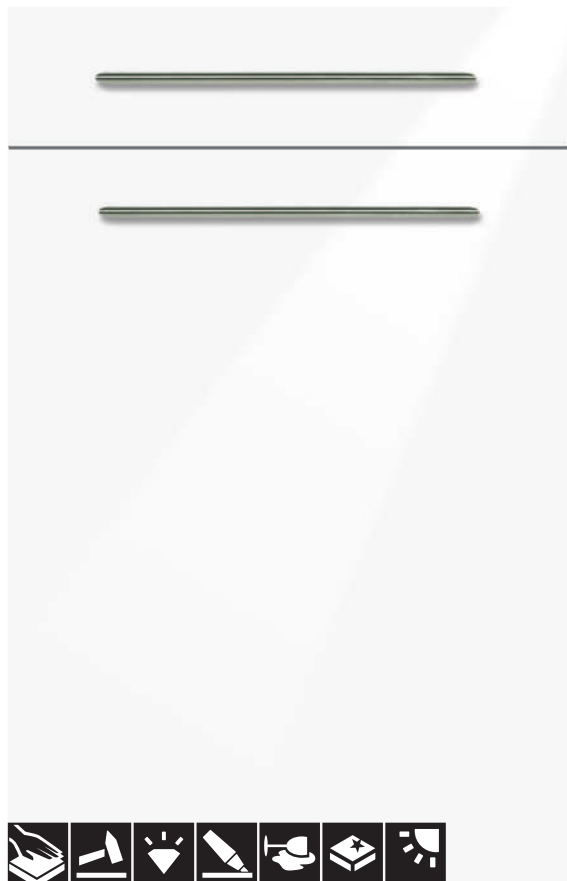
**cornices / light pelmets**



N 400, N 475,  
N 485,  
N 900 N 975,

<p><b>Front decor</b> Light Pepper</p> <p><b>Surface</b> Velvet lacquer putty effect</p>  <p><b>XL 30049</b></p> <p><b>Reference carcass</b> K218P Light Pepper</p> <p><b>Visible sides</b> R218W Light Pepper</p>	<p><b>Front decor</b> premium white</p> <p><b>Surface</b> Velvet lacquer putty effect</p>  <p><b>XL 30050</b></p> <p><b>Reference carcass</b> K039P Premium white</p> <p><b>Visible sides</b> R039W Premium white</p>	<p><b>Front decor</b> White Agate</p> <p><b>Surface</b> Velvet lacquer putty effect</p>  <p><b>XL 30056</b></p> <p><b>Reference carcass</b> K178F White Agate</p> <p><b>Visible sides</b> R178W White Agate</p>								
<p><b>Front decor</b> Night Green</p> <p><b>Surface</b> Velvet lacquer putty effect</p>  <p><b>XL 30059</b></p> <p><b>Reference carcass</b> K075P Black</p> <p><b>Visible sides</b> R245W Night Green</p>	<p><b>Front decor</b> light grey</p> <p><b>Surface</b> Velvet lacquer putty effect</p>  <p><b>XL 30060</b></p> <p><b>Reference carcass</b> K006P Light Grey</p> <p><b>Visible sides</b> R006W Light Grey</p>	<p><b>Front decor</b> Art Pepper</p> <p><b>Surface</b> Velvet lacquer putty effect</p>  <p><b>XL 30062</b></p> <p><b>Reference carcass</b> K230P Art Pepper</p> <p><b>Visible sides</b> R230W Art Pepper</p>								
<p><b>Front decor</b> Macaron</p> <p><b>Surface</b> Velvet lacquer putty effect</p>  <p><b>XL 30065</b></p> <p><b>Reference carcass</b> K076P Macaron</p> <p><b>Visible sides</b> R076W Macaron</p>	<p><b>Front decor</b> Light Nude</p> <p><b>Surface</b> Velvet lacquer putty effect</p>  <p><b>XL 30066</b></p> <p><b>Reference carcass</b> K248P Light Nude</p> <p><b>Visible sides</b> R248W Light Nude</p>	<p><b>Front decor</b> Fango</p> <p><b>Surface</b> Velvet lacquer putty effect</p>  <p><b>XL 30067</b></p> <p><b>Reference carcass</b> K263P Fango</p> <p><b>Visible sides</b> R263W Fango</p>								
<p><b>Front decor</b> magic grey</p> <p><b>Surface</b> Velvet lacquer putty effect</p>  <p><b>XL 30084</b></p> <p><b>Reference carcass</b> K058P Magic-grey</p> <p><b>Visible sides</b> R058W Magic-grey</p>	<p><b>Front decor</b> graphite black</p> <p><b>Surface</b> Velvet lacquer putty effect</p>  <p><b>XL 30095</b></p> <p><b>Reference carcass</b> K043P Graphite Black</p> <p><b>Visible sides</b> R043W Graphite Black</p>	<p><b>Front decor</b> black</p> <p><b>Surface</b> Velvet lacquer putty effect</p>  <p><b>XL 30098</b></p> <p><b>Reference carcass</b> K075P Black</p> <p><b>Visible sides</b> R075W Black</p>								
<p><b>Front decor</b> special colour</p> <p><b>Surface</b> Velvet lacquer putty effect</p>  <p><b>XL 30099</b></p> <p><b>Reference carcass</b> K023P Stainless Steel Colour</p> <p><b>Visible sides</b> R099W special colour</p>	<p style="text-align: center;"><b>Colour concept at no extra charge</b></p> <table border="1"> <tbody> <tr> <td data-bbox="596 1753 831 1839">  Sealbrown RAL 8019                 </td> <td data-bbox="836 1753 1064 1839">  Cristal red SIKKENS C0.60.30                 </td> </tr> <tr> <td data-bbox="596 1845 831 1930">  Savona green SIKKENS K0.05.47                 </td> <td data-bbox="836 1845 1064 1930">  Victoria green RAL 180 30 10                 </td> </tr> <tr> <td data-bbox="596 1937 831 2022">  Night Red SIKKENS C0.20.20                 </td> <td data-bbox="836 1937 1064 2022">  Blackblue SIKKENS U0.10.20                 </td> </tr> <tr> <td data-bbox="596 2029 831 2096">  Jade, pastel RAL 7032                 </td> <td data-bbox="836 2029 1064 2096">  live simple! No. 8                 </td> </tr> </tbody> </table>		 Sealbrown RAL 8019	 Cristal red SIKKENS C0.60.30	 Savona green SIKKENS K0.05.47	 Victoria green RAL 180 30 10	 Night Red SIKKENS C0.20.20	 Blackblue SIKKENS U0.10.20	 Jade, pastel RAL 7032	 live simple! No. 8
 Sealbrown RAL 8019	 Cristal red SIKKENS C0.60.30									
 Savona green SIKKENS K0.05.47	 Victoria green RAL 180 30 10									
 Night Red SIKKENS C0.20.20	 Blackblue SIKKENS U0.10.20									
 Jade, pastel RAL 7032	 live simple! No. 8									

**XL** **GL** **SMART GLAS** << 31-119 cm >>



**Reference carcass**  
**K160G**  
 Snow White Gloss

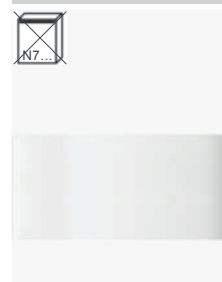
**Visible sides**  
**Q160H**  
 Snow White

**XL 4031**

**Front decor** SMARTGLAS, high-gloss snow white (rear texture in same colour)  
**Surface** Polymeric glass 2.0 mm smooth  
**Front thickness** 19 mm  
**Door shape** 15,089 kg/sqm excluding handle weight (see handles) straight, 4 sides with contoured PP edge, same colour  
**Front material** MDF material with high-grade 2 mm polymeric glass coating and 2 mm stabilising layer

**Note:**  
 Range always without tightening fitting!

**Available glass doors for specific models**



**Segment glass door**  
 e.g. HG 50 78 34 SE

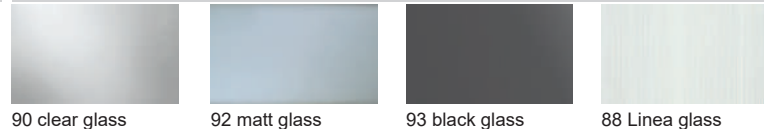


**Semi-frameless glass door...**  
 e.g. HG 50 78 34 LS

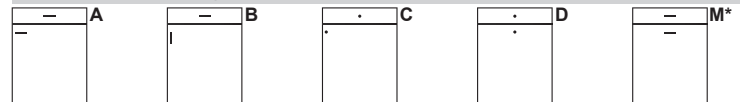


**Semi-frameless glass door / glass width 5 cm...**  
 e.g. HG 50 78 34 LB

**Available glass versions**




**Available handle arrangements**



\* = Standard finish

**Grip ledges**      **Handles**      **cornices / light pelmets**

 N 400, N 475,  
 N 485,  
 N 900 N 975,

**Front decor** SMARTGLAS high-gloss Carrara white

**Surface** Polymeric glass 2.0 mm smooth



**XL 4011**

**Note: Cannot be combined with premium white**

**Reference carcass**  
K023P  
Stainless Steel Colour

**Visible sides**  
Q200H  
Carrara white

**Front decor** SMARTGLAS high-gloss cream

**Surface** Polymeric glass 2.0 mm smooth



**XL 4016**

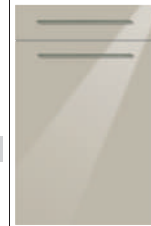
**Note: Cannot be combined with Macaron**

**Reference carcass**  
K023P  
Stainless Steel Colour

**Visible sides**  
Q201H  
Cream

**Front decor** SMARTGLAS high-gloss sand grey

**Surface** Polymeric glass 2.0 mm smooth



**XL 4021**

**Reference carcass**  
K023P  
Stainless Steel Colour

**Visible sides**  
Q191H  
Sand grey

**Front decor** SMARTGLAS, high-gloss black

**Surface** Polymeric glass 2.0 mm smooth



**XL 4036**

**Reference carcass**  
K075P  
Black

**Visible sides**  
Q075H  
Black

**Front decor** SMARTGLAS, high-gloss white agate

**Surface** Polymeric glass 2.0 mm smooth

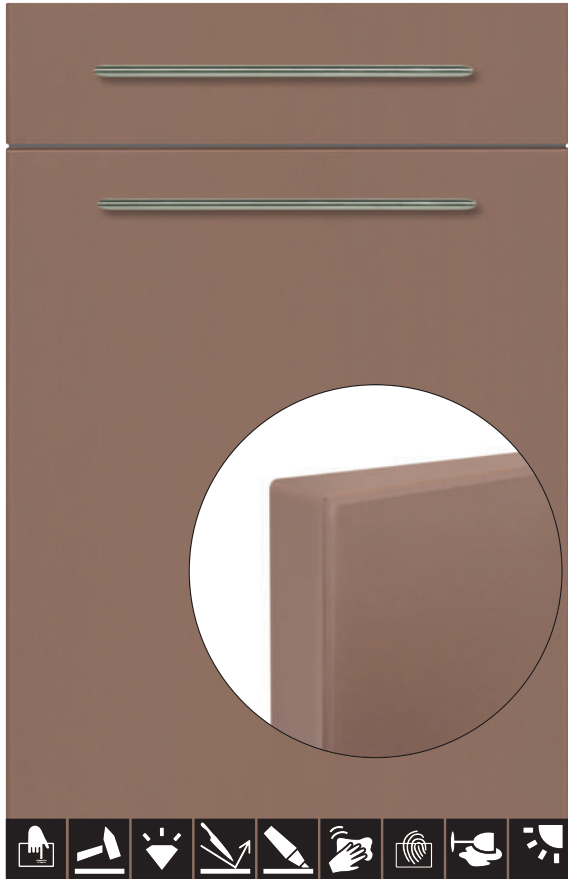


**XL 4041**

**Reference carcass**  
K178F  
White Agate

**Visible sides**  
Q178H  
White Agate

**XL** **GL** **SMART GLAS** << 31-119 cm >>



**Reference carcass**



**K235P**  
Titan Steel

**Visible sides**



**Q278M**  
Bronze Metallic

**XL 4691**

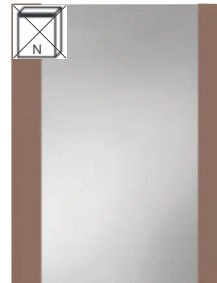
**Front decor** SMARTGLAS satin-finish bronze metallic (rear texture in same colour)  
**Surface** Polymeric glass 2.0 mm smooth  
**Front thickness** 19 mm  
**Door shape** 15,089 kg/sqm excluding handle weight (see handles)  
 straight, 4 sides with contoured PP edge, same colour  
**Front material** MDF material with high-grade 2 mm polymeric glass coating and 2 mm stabilising layer

**NEW**

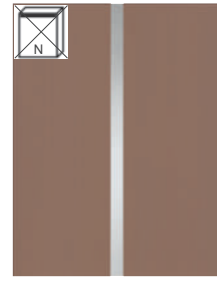
**Available glass doors for specific models**



**Segment glass door**  
e.g. HG 50 78 34 SE



**Semi-frameless glass door...**  
e.g. HG 50 78 34 LS



**Semi-frameless glass door / glass width 5 cm...**  
e.g. HG 50 78 34 LB

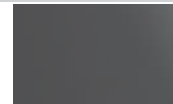
**Available glass versions**



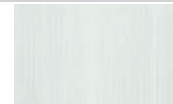
90 clear glass



92 matt glass

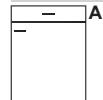


93 black glass



88 Linea glass

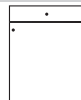
**Available handle arrangements**



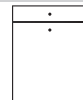
**A**



**B**



**C**



**D**



**M\***

\* = Standard finish

**Grip ledges**



N 400, N 475,  
N 900 N 975,


**Handles**

**cornices / light pelmets**



**Front decor** SMARTGLAS, satin-finish Carrara white

**Surface** Polymeric glass 2.0 mm smooth



**XL 4601**


**Note: Cannot be combined with premium white**

**Reference carcass**  
K023P  
Stainless Steel Colour

**Visible sides**  
Q200M  
Carrara white

**Front decor** SMARTGLAS, satin-finish cream

**Surface** Polymeric glass 2.0 mm smooth



**XL 4606**


**Note: Cannot be combined with Macaron**

**Reference carcass**  
K023P  
Stainless Steel Colour

**Visible sides**  
Q201M  
Cream

**Front decor** SMARTGLAS satin-finish sand grey

**Surface** Polymeric glass 2.0 mm smooth




**XL 4611**

**Reference carcass**  
K023P  
Stainless Steel Colour

**Visible sides**  
Q191M  
Sand grey

**Front decor** SMARTGLAS, satin-finish taupe

**Surface** Polymeric glass 2.0 mm smooth




**XL 4616**

**Reference carcass**  
K023P  
Stainless Steel Colour

**Visible sides**  
Q192M  
Taupe

**Front decor** SMARTGLAS, satin-finish snow white

**Surface** Polymeric glass 2.0 mm smooth




**XL 4621**

**Reference carcass**  
K160F  
Snow white

**Visible sides**  
Q160M  
Snow White

**Front decor** SMARTGLAS, satin-finish black

**Surface** Polymeric glass 2.0 mm smooth




**XL 4626**

**Reference carcass**  
K075P  
Black

**Visible sides**  
Q075M  
Black

**Front decor** SMARTGLAS, satin-finish agate white

**Surface** Polymeric glass 2.0 mm smooth




**XL 4631**

**Reference carcass**  
K178F  
White Agate

**Visible sides**  
Q178M  
White Agate

**Front decor** SMARTGLAS, satin-finish carbon metallic

**Surface** Polymeric glass 2.0 mm smooth




**XL 4641**

**Reference carcass**  
K075P  
Black

**Visible sides**  
Q234M  
Carbon metallic

**Front decor** SMARTGLAS, satin-finish, Aqua

**Surface** Polymeric glass 2.0 mm smooth




**XL 4666**

**Reference carcass**  
K235P  
Titan Steel

**Visible sides**  
Q244M  
Aqua

**Front decor** SMARTGLAS satin-finish black metallic

**Surface** Polymeric glass 2.0 mm smooth




**XL 4671**

**Reference carcass**  
K075P  
Black

**Visible sides**  
Q254M  
Black metallic

**Front decor** SMARTGLAS satin-finish champagne metallic

**Surface** Polymeric glass 2.0 mm smooth




**XL 4676**

**Reference carcass**  
K043P  
Graphite Black

**Visible sides**  
Q255M  
Champagne metallic

**Front decor** SMARTGLAS satin-finish grey metallic

**Surface** Polymeric glass 2.0 mm smooth




**XL 4681**

**Reference carcass**  
K075P  
Black

**Visible sides**  
Q256M  
Grey metallic

**Front decor** SMARTGLAS satin-finish silk metallic

**Surface** Polymeric glass 2.0 mm smooth

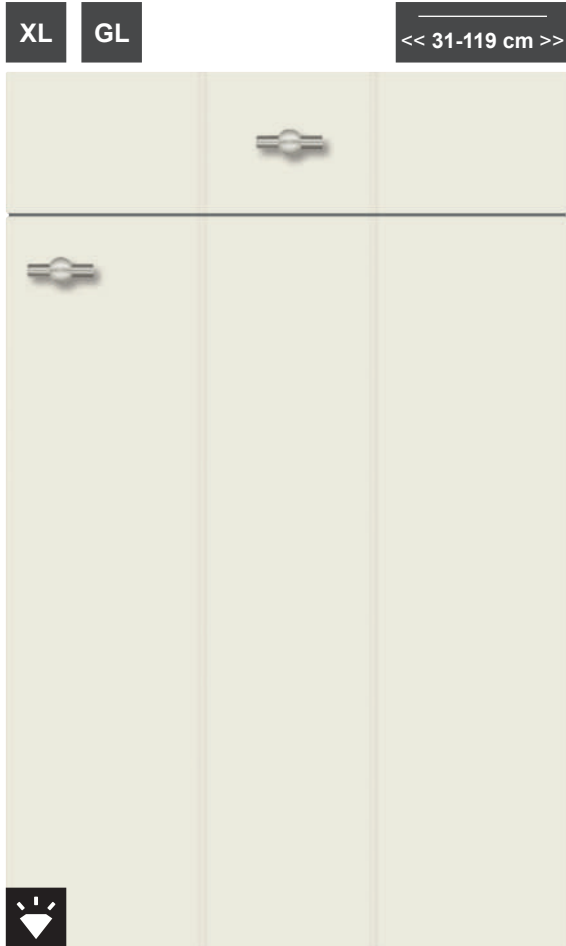


**XL 4686**

**Reference carcass**  
K058P  
Magic-grey

**NEW**

**Visible sides**  
Q277M  
Silk Metallic



**XL 4250**

- Front decor** premium white (rear in same colour)
- Surface** Micro textured lacquer
- Front thickness** 19 mm
- Door shape** 14,054 kg/sqm excluding handle weight (see handles)  
Coffered door, rounded on all sides, radius 2 mm, with 150 mm vertical grooving
- Front material** MDF substrate with high-quality lacquered surface

**Note:**  
Width 20 is supplied with smooth fronts  
Please avoid combining different front widths on the same single cabinet type!

**Available glass doors for specific models**

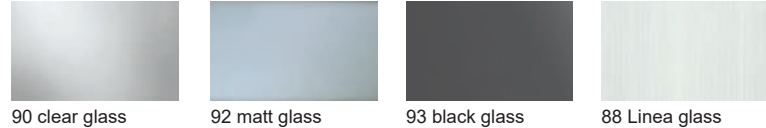


**Semi-frameless glass door...**  
e.g. HG 50 78 34 LS

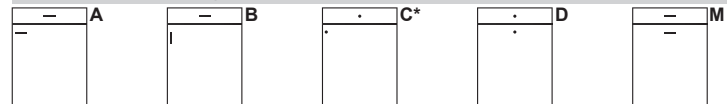
**Reference carcase**  
K039P  
Premium white

**Visible sides**  
S039P  
Premium white

**Available glass versions**




**Available handle arrangements**

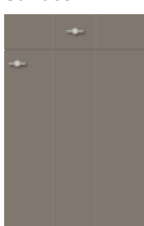


\* = Standard finish

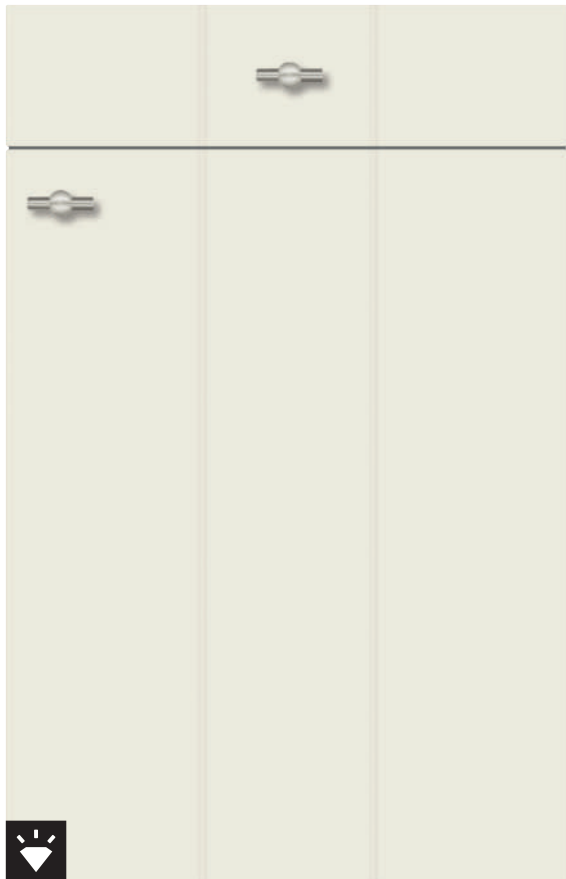
**Grip ledges                      Handles                      cornices / light pelmets**

 N 400, N 475,  
N 485,  
N 900 N 975,

 M330  
M340

<p><b>Front decor</b> snow white</p> <p><b>Surface</b> Micro textured lacquer</p>  <p><b>XL 4246</b></p> <p><b>Reference carcass</b> K160F Snow white</p> <p><b>Visible sides</b> S160P Snow White</p>	<p><b>Front decor</b> Light Pepper</p> <p><b>Surface</b> Micro textured lacquer</p>  <p><b>XL 4249</b></p> <p><b>Reference carcass</b> K218P Light Pepper</p> <p><b>Visible sides</b> S218P Light Pepper</p>	<p><b>Front decor</b> White Agate</p> <p><b>Surface</b> Micro textured lacquer</p>  <p><b>XL 4256</b></p> <p><b>Reference carcass</b> K178F White Agate</p> <p><b>Visible sides</b> S178P White Agate</p>								
<p><b>Front decor</b> Night Green</p> <p><b>Surface</b> Micro textured lacquer</p>  <p><b>XL 4259</b></p> <p><b>Reference carcass</b> K075P Black</p> <p><b>Visible sides</b> S245P Night Green</p>	<p><b>Front decor</b> light grey</p> <p><b>Surface</b> Micro textured lacquer</p>  <p><b>XL 4260</b></p> <p><b>Reference carcass</b> K006P Light Grey</p> <p><b>Visible sides</b> S006P Light Grey</p>	<p><b>Front decor</b> Art Pepper</p> <p><b>Surface</b> Micro textured lacquer</p>  <p><b>XL 4261</b></p> <p><b>Reference carcass</b> K230P Art Pepper</p> <p><b>Visible sides</b> S230P Art Pepper</p>								
<p><b>Front decor</b> Macaron</p> <p><b>Surface</b> Micro textured lacquer</p>  <p><b>XL 4265</b></p> <p><b>Reference carcass</b> K076P Macaron</p> <p><b>Visible sides</b> S076P Macaron</p>	<p><b>Front decor</b> Light Nude</p> <p><b>Surface</b> Micro textured lacquer</p>  <p><b>XL 4266</b></p> <p><b>Reference carcass</b> K248P Light Nude</p> <p><b>Visible sides</b> S248P Light Nude</p>	<p><b>Front decor</b> Fango</p> <p><b>Surface</b> Micro textured lacquer</p>  <p><b>XL 4267</b></p> <p><b>Reference carcass</b> K263P Fango</p> <p><b>Visible sides</b> S263P Fango</p>								
<p><b>Front decor</b> magic grey</p> <p><b>Surface</b> Micro textured lacquer</p>  <p><b>XL 4284</b></p> <p><b>Reference carcass</b> K058P Magic-grey</p> <p><b>Visible sides</b> S058P Magic-grey</p>	<p><b>Front decor</b> graphite black</p> <p><b>Surface</b> Micro textured lacquer</p>  <p><b>XL 4295</b></p> <p><b>Reference carcass</b> K043P Graphite Black</p> <p><b>Visible sides</b> S043P Graphite Black</p>	<p><b>Front decor</b> black</p> <p><b>Surface</b> Micro textured lacquer</p>  <p><b>XL 4298</b></p> <p><b>Reference carcass</b> K075P Black</p> <p><b>Visible sides</b> S075P Black</p>								
<p><b>Front decor</b> special colour</p> <p><b>Surface</b> Micro textured lacquer</p>  <p><b>XL 4299</b></p> <p><b>Reference carcass</b> K023P Stainless Steel Colour</p> <p><b>Visible sides</b> S099P special colour</p>	<p style="text-align: center;"><b>Colour concept at no extra charge</b></p> <table border="1"> <tbody> <tr> <td data-bbox="598 1747 829 1836">  Sealbrown RAL 8019                 </td> <td data-bbox="829 1747 1061 1836">  Cristal red SIKKENS C0.60.30                 </td> </tr> <tr> <td data-bbox="598 1836 829 1926">  Savona green SIKKENS K0.05.47                 </td> <td data-bbox="829 1836 1061 1926">  Victoria green RAL 180 30 10                 </td> </tr> <tr> <td data-bbox="598 1926 829 2016">  Night Red SIKKENS C0.20.20                 </td> <td data-bbox="829 1926 1061 2016">  Blackblue SIKKENS U0.10.20                 </td> </tr> <tr> <td data-bbox="598 2016 829 2096">  Jade, pastel RAL 7032                 </td> <td data-bbox="829 2016 1061 2096">  live simple! No. 8                 </td> </tr> </tbody> </table>		 Sealbrown RAL 8019	 Cristal red SIKKENS C0.60.30	 Savona green SIKKENS K0.05.47	 Victoria green RAL 180 30 10	 Night Red SIKKENS C0.20.20	 Blackblue SIKKENS U0.10.20	 Jade, pastel RAL 7032	 live simple! No. 8
 Sealbrown RAL 8019	 Cristal red SIKKENS C0.60.30									
 Savona green SIKKENS K0.05.47	 Victoria green RAL 180 30 10									
 Night Red SIKKENS C0.20.20	 Blackblue SIKKENS U0.10.20									
 Jade, pastel RAL 7032	 live simple! No. 8									

**XL** **GL** << 31-119 cm >>



**XL 4850**

- Front decor** premium white (rear in same colour)
- Surface** Velvet lacquer
- Front thickness** 19 mm
- Door shape** 14,054 kg/sqm excluding handle weight (see handles)  
Coffered door, rounded on all sides, radius 2 mm, with 150 mm vertical grooving
- Front material** MDF substrate with high-quality lacquered surface

**Note:**  
Width 20 is supplied with smooth fronts  
Please avoid combining different front widths on the same single cabinet type!

**Available glass doors for specific models**



**Semi-frameless glass door...**  
e.g. HG 50 78 34 LS



**Reference carcase**  
**K039P**  
Premium white

**Visible sides**  
**B039F**  
Premium white

**Available glass versions**

90 clear glass	92 matt glass	93 black glass	88 Linea glass


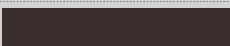
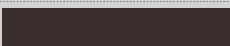
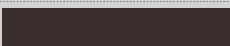
**Available handle arrangements**

--	--	--	--	--

\* = Standard finish

**Grip ledges** **Handles** **cornices / light pelmets**

 N 400, N 475, N 485, N 900 N 975,	 M330 M340	
---	------------------	--

<p><b>Front decor</b> snow white</p> <p><b>Surface</b> Velvet lacquer</p>  <p><b>XL 4846</b></p> <p><b>Reference carcass</b> K160F Snow white</p> <p><b>Visible sides</b> B160F Snow White</p>	<p><b>Front decor</b> Light Pepper</p> <p><b>Surface</b> Velvet lacquer</p>  <p><b>XL 4849</b></p> <p><b>Reference carcass</b> K218P Light Pepper</p> <p><b>Visible sides</b> B218F Light Pepper</p>	<p><b>Front decor</b> White Agate</p> <p><b>Surface</b> Velvet lacquer</p>  <p><b>XL 4856</b></p> <p><b>Reference carcass</b> K178F White Agate</p> <p><b>Visible sides</b> B178F White Agate</p>								
<p><b>Front decor</b> Night Green</p> <p><b>Surface</b> Velvet lacquer</p>  <p><b>XL 4859</b></p> <p><b>Reference carcass</b> K075P Black</p> <p><b>Visible sides</b> B245F Night Green</p>	<p><b>Front decor</b> Art Pepper</p> <p><b>Surface</b> Velvet lacquer</p>  <p><b>XL 4861</b></p> <p><b>Reference carcass</b> K230P Art Pepper</p> <p><b>Visible sides</b> B230F Art Pepper</p>	<p><b>Front decor</b> Macaron</p> <p><b>Surface</b> Velvet lacquer</p>  <p><b>XL 4865</b></p> <p><b>Reference carcass</b> K076P Macaron</p> <p><b>Visible sides</b> B076F Macaron</p>								
<p><b>Front decor</b> Light Nude</p> <p><b>Surface</b> Velvet lacquer</p>  <p><b>XL 4866</b></p> <p><b>Reference carcass</b> K248P Light Nude</p> <p><b>Visible sides</b> B248F Light Nude</p>	<p><b>Front decor</b> Fango</p> <p><b>Surface</b> Velvet lacquer</p>  <p><b>XL 4867</b></p> <p><b>Reference carcass</b> K263P Fango</p> <p><b>Visible sides</b> B263F Fango</p>	<p><b>Front decor</b> magic grey</p> <p><b>Surface</b> Velvet lacquer</p>  <p><b>XL 4884</b></p> <p><b>Reference carcass</b> K058P Magic-grey</p> <p><b>Visible sides</b> B058F Magic-grey</p>								
<p><b>Front decor</b> light grey</p> <p><b>Surface</b> Velvet lacquer</p>  <p><b>XL 4885</b></p> <p><b>Reference carcass</b> K006P Light Grey</p> <p><b>Visible sides</b> B006F Light Grey</p>	<p><b>Front decor</b> graphite black</p> <p><b>Surface</b> Velvet lacquer</p>  <p><b>XL 4895</b></p> <p><b>Reference carcass</b> K043P Graphite Black</p> <p><b>Visible sides</b> B043F Graphite Black</p>	<p><b>Front decor</b> black</p> <p><b>Surface</b> Velvet lacquer</p>  <p><b>XL 4898</b></p> <p><b>Reference carcass</b> K075P Black</p> <p><b>Visible sides</b> B075F Black</p>								
<p><b>Front decor</b> special colour</p> <p><b>Surface</b> Velvet lacquer</p>  <p><b>XL 4899</b></p> <p><b>Reference carcass</b> K023P Stainless Steel Colour</p> <p><b>Visible sides</b> B099F special colour</p>	<p style="text-align: center;"><b>Colour concept at no extra charge</b></p> <table border="1"> <tbody> <tr> <td data-bbox="598 1747 829 1836">  Sealbrown RAL 8019                 </td> <td data-bbox="834 1747 1066 1836">  Cristal red SIKKENS C0.60.30                 </td> </tr> <tr> <td data-bbox="598 1843 829 1933">  Savona green SIKKENS K0.05.47                 </td> <td data-bbox="834 1843 1066 1933">  Victoria green RAL 180 30 10                 </td> </tr> <tr> <td data-bbox="598 1939 829 2029">  Night Red SIKKENS C0.20.20                 </td> <td data-bbox="834 1939 1066 2029">  Blackblue SIKKENS U0.10.20                 </td> </tr> <tr> <td data-bbox="598 2036 829 2096">  Jade, pastel RAL 7032                 </td> <td data-bbox="834 2036 1066 2096">  live simple! No. 8                 </td> </tr> </tbody> </table>		 Sealbrown RAL 8019	 Cristal red SIKKENS C0.60.30	 Savona green SIKKENS K0.05.47	 Victoria green RAL 180 30 10	 Night Red SIKKENS C0.20.20	 Blackblue SIKKENS U0.10.20	 Jade, pastel RAL 7032	 live simple! No. 8
 Sealbrown RAL 8019	 Cristal red SIKKENS C0.60.30									
 Savona green SIKKENS K0.05.47	 Victoria green RAL 180 30 10									
 Night Red SIKKENS C0.20.20	 Blackblue SIKKENS U0.10.20									
 Jade, pastel RAL 7032	 live simple! No. 8									



**XL 44446**

**Front decor** snow white  
(rear in same colour)  
**Surface** Micro textured lacquer  
**Front thickness** 19 mm  
**Door shape** 14,054 kg/sqm excluding handle weight (see handles)  
 coffered front, frame width 75 mm  
**Front material** MDF substrate with high-quality lacquered surface

**Note:**  
 Width 15 cm is supplied with smooth fronts  
 Width 20 cm is supplied with smooth fronts  
 Range always without tightening fitting!

**Available glass doors for specific models**



**Framed glass door...**  
 e.g. HG 50 78 34 RA



**Framed glass door...**  
 e.g. HGS 50 78 34



**Framed glass door.../ crossbar**  
 e.g. HGKS 50 78 34

**Reference carcass**  
**K160F**  
 Snow white

**Visible sides**  
**S160P**  
 Snow White

**Available glass versions**







90 clear glass	92 matt glass	93 black glass	88 Linea glass

**Available handle arrangements**

--	--	--	--	--

\* = Standard finish

<b>Grip ledges</b>	<b>Handles</b>	<b>cornices / light pelmets</b>
N 400, N 475, N 485, N 700, N 775 N 900 N 975,	M330 M340	

<p><b>Front decor</b> premium white</p> <p><b>Surface</b> Micro textured lacquer</p>  <p><b>XL 44450</b></p> <p><b>Reference carcass</b> K039P Premium white</p> <p><b>Visible sides</b> S039P Premium white</p>	<p><b>Front decor</b> White Agate</p> <p><b>Surface</b> Micro textured lacquer</p>  <p><b>XL 44456</b></p> <p><b>Reference carcass</b> K178F White Agate</p> <p><b>Visible sides</b> S178P White Agate</p>	<p><b>Front decor</b> Night Green</p> <p><b>Surface</b> Micro textured lacquer</p>  <p><b>XL 44459</b></p> <p><b>Reference carcass</b> K075P Black</p> <p><b>Visible sides</b> S245P Night Green</p>								
<p><b>Front decor</b> light grey</p> <p><b>Surface</b> Micro textured lacquer</p>  <p><b>XL 44460</b></p> <p><b>Reference carcass</b> K006P Light Grey</p> <p><b>Visible sides</b> S206P Light Grey</p>	<p><b>Front decor</b> Art Pepper</p> <p><b>Surface</b> Micro textured lacquer</p>  <p><b>XL 44461</b></p> <p><b>Reference carcass</b> K230P Art Pepper</p> <p><b>Visible sides</b> S230P Art Pepper</p>	<p><b>Front decor</b> Macaron</p> <p><b>Surface</b> Micro textured lacquer</p>  <p><b>XL 44465</b></p> <p><b>Reference carcass</b> K076P Macaron</p> <p><b>Visible sides</b> S076P Macaron</p>								
<p><b>Front decor</b> Light Nude</p> <p><b>Surface</b> Micro textured lacquer</p>  <p><b>XL 44466</b></p> <p><b>Reference carcass</b> K248P Light Nude</p> <p><b>Visible sides</b> S248P Light Nude</p>	<p><b>Front decor</b> Fango</p> <p><b>Surface</b> Micro textured lacquer</p>  <p><b>XL 44467</b></p> <p><b>Reference carcass</b> K263P Fango</p> <p><b>Visible sides</b> S263P Fango</p>	<p><b>Front decor</b> Light Pepper</p> <p><b>Surface</b> Micro textured lacquer</p>  <p><b>XL 44469</b></p> <p><b>Reference carcass</b> K218P Light Pepper</p> <p><b>Visible sides</b> S218P Light Pepper</p>								
<p><b>Front decor</b> magic grey</p> <p><b>Surface</b> Micro textured lacquer</p>  <p><b>XL 44484</b></p> <p><b>Reference carcass</b> K058P Magic-grey</p> <p><b>Visible sides</b> S058P Magic-grey</p>	<p><b>Front decor</b> graphite black</p> <p><b>Surface</b> Micro textured lacquer</p>  <p><b>XL 44495</b></p> <p><b>Reference carcass</b> K043P Graphite Black</p> <p><b>Visible sides</b> S043P Graphite Black</p>	<p><b>Front decor</b> black</p> <p><b>Surface</b> Micro textured lacquer</p>  <p><b>XL 44498</b></p> <p><b>Reference carcass</b> K075P Black</p> <p><b>Visible sides</b> S075P Black</p>								
<p><b>Front decor</b> special colour</p> <p><b>Surface</b> Micro textured lacquer</p>  <p><b>XL 44499</b></p> <p><b>Reference carcass</b> K023P Stainless Steel Colour</p> <p><b>Visible sides</b> S099P special colour</p>	<p style="text-align: center;"><b>Colour concept at no extra charge</b></p> <table border="1"> <tbody> <tr> <td data-bbox="595 1751 831 1841">  Sealbrown RAL 8019                 </td> <td data-bbox="831 1751 1062 1841">  Cristal red SIKKENS C0.60.30                 </td> </tr> <tr> <td data-bbox="595 1841 831 1930">  Savona green SIKKENS K0.05.47                 </td> <td data-bbox="831 1841 1062 1930">  Victoria green RAL 180 30 10                 </td> </tr> <tr> <td data-bbox="595 1930 831 2020">  Night Red SIKKENS C0.20.20                 </td> <td data-bbox="831 1930 1062 2020">  Blackblue SIKKENS U0.10.20                 </td> </tr> <tr> <td data-bbox="595 2020 831 2096">  Jade, pastel RAL 7032                 </td> <td data-bbox="831 2020 1062 2096">  live simple! No. 8                 </td> </tr> </tbody> </table>		 Sealbrown RAL 8019	 Cristal red SIKKENS C0.60.30	 Savona green SIKKENS K0.05.47	 Victoria green RAL 180 30 10	 Night Red SIKKENS C0.20.20	 Blackblue SIKKENS U0.10.20	 Jade, pastel RAL 7032	 live simple! No. 8
 Sealbrown RAL 8019	 Cristal red SIKKENS C0.60.30									
 Savona green SIKKENS K0.05.47	 Victoria green RAL 180 30 10									
 Night Red SIKKENS C0.20.20	 Blackblue SIKKENS U0.10.20									
 Jade, pastel RAL 7032	 live simple! No. 8									



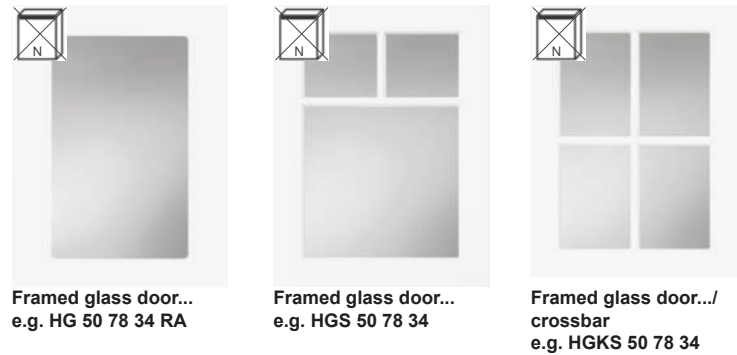


**XL 43546**

- Front decor** snow white  
(rear in same colour)
- Surface** Velvet lacquer
- Front thickness** 19 mm
- Door shape** 14,054 kg/sqm excluding handle weight (see handles)  
coffered front, frame width 75 mm
- Front material** MDF substrate with high-quality lacquered surface

**Note:**  
 Width 15 cm is supplied with smooth fronts  
 Width 20 cm is supplied with smooth fronts  
 Range always without tightening fitting!

**Available glass doors for specific models**



**Framed glass door...**  
e.g. HG 50 78 34 RA

**Framed glass door...**  
e.g. HGS 50 78 34

**Framed glass door.../ crossbar**  
e.g. HGKS 50 78 34

**Reference carcass**

**K160F**  
Snow white

**Visible sides**

**B160F**  
Snow White



**Available glass versions**

90 clear glass    92 matt glass    93 black glass    88 Linea glass

**Available handle arrangements**

**\* = Standard finish**

<b>Grip ledges</b>	<b>Handles</b>	<b>cornices / light pelmets</b>
N 400, N 475, N 485, N 700, N 775 N 900 N 975,	M330 M340	

<p><b>Front decor</b> premium white <b>Surface</b> Velvet lacquer</p> <p><b>XL 43550</b></p>  <p><b>Reference carcass</b> K039P Premium white</p> <p><b>Visible sides</b> B039F Premium white</p>	<p><b>Front decor</b> White Agate <b>Surface</b> Velvet lacquer</p> <p><b>XL 43556</b></p>  <p><b>Reference carcass</b> K178F White Agate</p> <p><b>Visible sides</b> B178F White Agate</p>	<p><b>Front decor</b> Night Green <b>Surface</b> Velvet lacquer</p> <p><b>XL 43559</b></p>  <p><b>Reference carcass</b> K075P Black</p> <p><b>Visible sides</b> B245F Night Green</p>								
<p><b>Front decor</b> light grey <b>Surface</b> Velvet lacquer</p> <p><b>XL 43560</b></p>  <p><b>Reference carcass</b> K006P Light Grey</p> <p><b>Visible sides</b> B006F Light Grey</p>	<p><b>Front decor</b> Art Pepper <b>Surface</b> Velvet lacquer</p> <p><b>XL 43561</b></p>  <p><b>Reference carcass</b> K230P Art Pepper</p> <p><b>Visible sides</b> B230F Art Pepper</p>	<p><b>Front decor</b> Macaron <b>Surface</b> Velvet lacquer</p> <p><b>XL 43565</b></p>  <p><b>Reference carcass</b> K076P Macaron</p> <p><b>Visible sides</b> B076F Macaron</p>								
<p><b>Front decor</b> Light Nude <b>Surface</b> Velvet lacquer</p> <p><b>XL 43566</b></p>  <p><b>Reference carcass</b> K248P Light Nude</p> <p><b>Visible sides</b> B248F Light Nude</p>	<p><b>Front decor</b> Fango <b>Surface</b> Velvet lacquer</p> <p><b>XL 43567</b></p>  <p><b>Reference carcass</b> K263P Fango</p> <p><b>Visible sides</b> B263F Fango</p>	<p><b>Front decor</b> Light Pepper <b>Surface</b> Velvet lacquer</p> <p><b>XL 43569</b></p>  <p><b>Reference carcass</b> K218P Light Pepper</p> <p><b>Visible sides</b> B218F Light Pepper</p>								
<p><b>Front decor</b> magic grey <b>Surface</b> Velvet lacquer</p> <p><b>XL 43584</b></p>  <p><b>Reference carcass</b> K058P Magic-grey</p> <p><b>Visible sides</b> B058F Magic-grey</p>	<p><b>Front decor</b> graphite black <b>Surface</b> Velvet lacquer</p> <p><b>XL 43595</b></p>  <p><b>Reference carcass</b> K043P Graphite Black</p> <p><b>Visible sides</b> B043F Graphite Black</p>	<p><b>Front decor</b> black <b>Surface</b> Velvet lacquer</p> <p><b>XL 43598</b></p>  <p><b>Reference carcass</b> K075P Black</p> <p><b>Visible sides</b> B075F Black</p>								
<p><b>Front decor</b> special colour <b>Surface</b> Velvet lacquer</p> <p><b>XL 43599</b></p>  <p><b>Reference carcass</b> K023P Stainless Steel Colour</p> <p><b>Visible sides</b> B099F special colour</p>	<p style="text-align: center;"><b>Colour concept at no extra charge</b></p> <table border="1"> <tbody> <tr> <td data-bbox="595 1751 831 1841">Sealbrown RAL 8019</td> <td data-bbox="831 1751 1062 1841">Cristal red SIKKENS C0.60.30</td> </tr> <tr> <td data-bbox="595 1841 831 1930">Savona green SIKKENS K0.05.47</td> <td data-bbox="831 1841 1062 1930">Victoria green RAL 180 30 10</td> </tr> <tr> <td data-bbox="595 1930 831 2020">Night Red SIKKENS C0.20.20</td> <td data-bbox="831 1930 1062 2020">Blackblue SIKKENS U0.10.20</td> </tr> <tr> <td data-bbox="595 2020 831 2096">Jade, pastel RAL 7032</td> <td data-bbox="831 2020 1062 2096">live simple! No. 8</td> </tr> </tbody> </table>		Sealbrown RAL 8019	Cristal red SIKKENS C0.60.30	Savona green SIKKENS K0.05.47	Victoria green RAL 180 30 10	Night Red SIKKENS C0.20.20	Blackblue SIKKENS U0.10.20	Jade, pastel RAL 7032	live simple! No. 8
Sealbrown RAL 8019	Cristal red SIKKENS C0.60.30									
Savona green SIKKENS K0.05.47	Victoria green RAL 180 30 10									
Night Red SIKKENS C0.20.20	Blackblue SIKKENS U0.10.20									
Jade, pastel RAL 7032	live simple! No. 8									



**XL 4665**

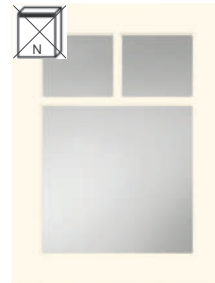
**Front decor** Macaron  
(rear in same colour)  
**Surface** Micro textured lacquer  
**Front thickness** 19 mm  
**Door shape** 15,135 kg/sqm excluding handle weight (see handles)  
 Modern coffered front with inner profile, frame width 75 mm  
**Front material** MDF substrate with high-quality lacquered surface

**Note:**  
 Width 15 cm is supplied with smooth fronts  
 Range always without tightening fitting!

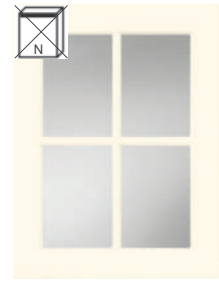
**Available glass doors for specific models**



**Framed glass door...**  
 e.g. HG 50 78 34 RA



**Framed glass door...**  
 e.g. HGS 50 78 34



**Framed glass door.../ crossbar**  
 e.g. HGKS 50 78 34

**Reference carcass**

**K076P**  
 Macaron

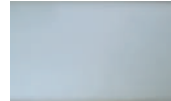
**Visible sides**

**S076P**  
 Macaron

**Available glass versions**



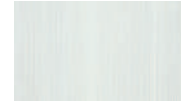
90 clear glass



92 matt glass

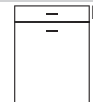
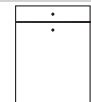
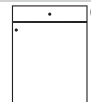
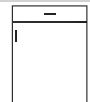
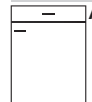


93 black glass



88 Linea glass

**Available handle arrangements**



\* = Standard finish

**Grip ledges**



N 400, N 475,  
 N 485,  
 N 900 N 975,  
 N 700, N 775

**Handles**



M330 M340

**cornices / light pelmets**



KL 105



LB 101

<p><b>Front decor</b> snow white</p> <p><b>Surface</b> Micro textured lacquer</p>  <p><b>XL 4646</b></p> <p><b>Reference carcass</b> K160F Snow white</p> <p><b>Visible sides</b> S160P Snow White</p>	<p><b>Front decor</b> premium white</p> <p><b>Surface</b> Micro textured lacquer</p>  <p><b>XL 4650</b></p> <p><b>Reference carcass</b> K039P Premium white</p> <p><b>Visible sides</b> S039P Premium white</p>	<p><b>Front decor</b> White Agate</p> <p><b>Surface</b> Micro textured lacquer</p>  <p><b>XL 4656</b></p> <p><b>Reference carcass</b> K178F White Agate</p> <p><b>Visible sides</b> S178P White Agate</p>								
<p><b>Front decor</b> Night Green</p> <p><b>Surface</b> Micro textured lacquer</p>  <p><b>XL 4659</b></p> <p><b>Reference carcass</b> K075P Black</p> <p><b>Visible sides</b> S245P Night Green</p>	<p><b>Front decor</b> light grey</p> <p><b>Surface</b> Micro textured lacquer</p>  <p><b>XL 4660</b></p> <p><b>Reference carcass</b> K006P Light Grey</p> <p><b>Visible sides</b> S006P Light Grey</p>	<p><b>Front decor</b> Art Pepper</p> <p><b>Surface</b> Micro textured lacquer</p>  <p><b>XL 4661</b></p> <p><b>Reference carcass</b> K230P Art Pepper</p> <p><b>Visible sides</b> S230P Art Pepper</p>								
<p><b>Front decor</b> Light Nude</p> <p><b>Surface</b> Micro textured lacquer</p>  <p><b>XL 4664</b></p> <p><b>Reference carcass</b> K248P Light Nude</p> <p><b>Visible sides</b> S248P Light Nude</p>	<p><b>Front decor</b> Fango</p> <p><b>Surface</b> Micro textured lacquer</p>  <p><b>XL 4667</b></p> <p><b>Reference carcass</b> K263P Fango</p> <p><b>Visible sides</b> S263P Fango</p>	<p><b>Front decor</b> Light Pepper</p> <p><b>Surface</b> Micro textured lacquer</p>  <p><b>XL 4669</b></p> <p><b>Reference carcass</b> K218P Light Pepper</p> <p><b>Visible sides</b> S218P Light Pepper</p>								
<p><b>Front decor</b> magic grey</p> <p><b>Surface</b> Micro textured lacquer</p>  <p><b>XL 4684</b></p> <p><b>Reference carcass</b> K058P Magic-grey</p> <p><b>Visible sides</b> S058P Magic-grey</p>	<p><b>Front decor</b> graphite black</p> <p><b>Surface</b> Micro textured lacquer</p>  <p><b>XL 4695</b></p> <p><b>Reference carcass</b> K043P Graphite Black</p> <p><b>Visible sides</b> S043P Graphite Black</p>	<p><b>Front decor</b> black</p> <p><b>Surface</b> Micro textured lacquer</p>  <p><b>XL 4698</b></p> <p><b>Reference carcass</b> K075P Black</p> <p><b>Visible sides</b> S075P Black</p>								
<p><b>Front decor</b> special colour</p> <p><b>Surface</b> Micro textured lacquer</p>  <p><b>XL 4699</b></p> <p><b>Reference carcass</b> K023P Stainless Steel Colour</p> <p><b>Visible sides</b> S099P special colour</p>	<p style="text-align: center;"><b>Colour concept at no extra charge</b></p> <table border="1"> <tbody> <tr> <td data-bbox="596 1753 831 1839">  Sealbrown RAL 8019                 </td> <td data-bbox="836 1753 1064 1839">  Cristal red SIKKENS C0.60.30                 </td> </tr> <tr> <td data-bbox="596 1845 831 1930">  Savona green SIKKENS K0.05.47                 </td> <td data-bbox="836 1845 1064 1930">  Victoria green RAL 180 30 10                 </td> </tr> <tr> <td data-bbox="596 1937 831 2022">  Night Red SIKKENS C0.20.20                 </td> <td data-bbox="836 1937 1064 2022">  Blackblue SIKKENS U0.10.20                 </td> </tr> <tr> <td data-bbox="596 2029 831 2096">  Jade, pastel RAL 7032                 </td> <td data-bbox="836 2029 1064 2096">  live simple! No. 8                 </td> </tr> </tbody> </table>		 Sealbrown RAL 8019	 Cristal red SIKKENS C0.60.30	 Savona green SIKKENS K0.05.47	 Victoria green RAL 180 30 10	 Night Red SIKKENS C0.20.20	 Blackblue SIKKENS U0.10.20	 Jade, pastel RAL 7032	 live simple! No. 8
 Sealbrown RAL 8019	 Cristal red SIKKENS C0.60.30									
 Savona green SIKKENS K0.05.47	 Victoria green RAL 180 30 10									
 Night Red SIKKENS C0.20.20	 Blackblue SIKKENS U0.10.20									
 Jade, pastel RAL 7032	 live simple! No. 8									



**XL 4765**

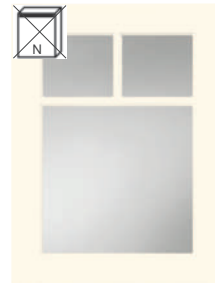
**Front decor** Macaron  
(rear in same colour)  
**Surface** Velvet lacquer  
**Front thickness** 19 mm  
**Door shape** 15,135 kg/sqm excluding handle weight (see handles)  
 Modern coffered front with inner profile, frame width 75 mm  
**Front material** MDF substrate with high-quality lacquered surface

**Note:**  
 Width 15 cm is supplied with smooth fronts  
 Range always without tightening fitting!

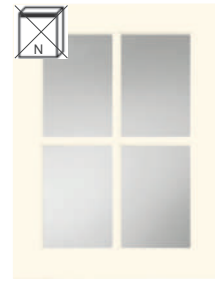
**Available glass doors for specific models**



**Framed glass door...**  
 e.g. HG 50 78 34 RA



**Framed glass door...**  
 e.g. HGS 50 78 34



**Framed glass door.../ crossbar**  
 e.g. HGKS 50 78 34

**Reference carcass**

**K076P**  
 Macaron

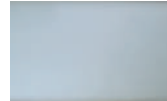
**Visible sides**

**B076F**  
 Macaron

**Available glass versions**



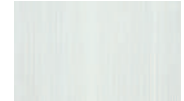
90 clear glass



92 matt glass

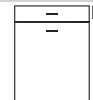
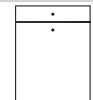
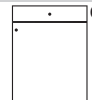
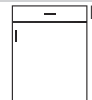
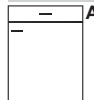


93 black glass



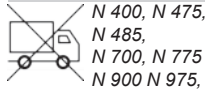
88 Linea glass

**Available handle arrangements**



\* = Standard finish

**Grip ledges**



**Handles**










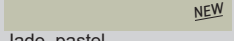



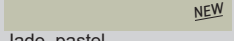



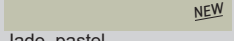


**cornices / light pelmets**



KL 105

LB 101

<p><b>Front decor</b> snow white</p> <p><b>Surface</b> Velvet lacquer</p>  <p><b>XL 4746</b></p> <p><b>Reference carcass</b> K160F Snow white</p> <p><b>Visible sides</b> B160F Snow White</p>	<p><b>Front decor</b> premium white</p> <p><b>Surface</b> Velvet lacquer</p>  <p><b>XL 4750</b></p> <p><b>Reference carcass</b> K039P Premium white</p> <p><b>Visible sides</b> B039F Premium white</p>	<p><b>Front decor</b> White Agate</p> <p><b>Surface</b> Velvet lacquer</p>  <p><b>XL 4756</b></p> <p><b>Reference carcass</b> K178F White Agate</p> <p><b>Visible sides</b> B178F White Agate</p>								
<p><b>Front decor</b> Night Green</p> <p><b>Surface</b> Velvet lacquer</p>  <p><b>XL 4759</b></p> <p><b>Reference carcass</b> K075P Black</p> <p><b>Visible sides</b> B245F Night Green</p>	<p><b>Front decor</b> Art Pepper</p> <p><b>Surface</b> Velvet lacquer</p>  <p><b>XL 4761</b></p> <p><b>Reference carcass</b> K230P Art Pepper</p> <p><b>Visible sides</b> B230F Art Pepper</p>	<p><b>Front decor</b> Light Nude</p> <p><b>Surface</b> Velvet lacquer</p>  <p><b>XL 4766</b></p> <p><b>Reference carcass</b> K248P Light Nude</p> <p><b>Visible sides</b> B248F Light Nude</p>								
<p><b>Front decor</b> Fango</p> <p><b>Surface</b> Velvet lacquer</p>  <p><b>XL 4767</b></p> <p><b>Reference carcass</b> K263P Fango</p> <p><b>Visible sides</b> B263F Fango</p>	<p><b>Front decor</b> Light Pepper</p> <p><b>Surface</b> Velvet lacquer</p>  <p><b>XL 4769</b></p> <p><b>Reference carcass</b> K218P Light Pepper</p> <p><b>Visible sides</b> B218F Light Pepper</p>	<p><b>Front decor</b> magic grey</p> <p><b>Surface</b> Velvet lacquer</p>  <p><b>XL 4784</b></p> <p><b>Reference carcass</b> K058P Magic-grey</p> <p><b>Visible sides</b> B058F Magic-grey</p>								
<p><b>Front decor</b> light grey</p> <p><b>Surface</b> Velvet lacquer</p>  <p><b>XL 4785</b></p> <p><b>Reference carcass</b> K006P Light Grey</p> <p><b>Visible sides</b> B006F Light Grey</p>	<p><b>Front decor</b> graphite black</p> <p><b>Surface</b> Velvet lacquer</p>  <p><b>XL 4795</b></p> <p><b>Reference carcass</b> K043P Graphite Black</p> <p><b>Visible sides</b> B043F Graphite Black</p>	<p><b>Front decor</b> black</p> <p><b>Surface</b> Velvet lacquer</p>  <p><b>XL 4798</b></p> <p><b>Reference carcass</b> K075P Black</p> <p><b>Visible sides</b> B075F Black</p>								
<p><b>Front decor</b> special colour</p> <p><b>Surface</b> Velvet lacquer</p>  <p><b>XL 4799</b></p> <p><b>Reference carcass</b> K023P Stainless Steel Colour</p> <p><b>Visible sides</b> B099F special colour</p>	<p style="text-align: center;"><b>Colour concept at no extra charge</b></p> <table border="1"> <tbody> <tr> <td data-bbox="596 1753 831 1839">                       Sealbrown RAL 8019                 </td> <td data-bbox="836 1753 1070 1839">                       Cristal red SIKKENS C0.60.30                 </td> </tr> <tr> <td data-bbox="596 1845 831 1930">                       Savona green SIKKENS K0.05.47                 </td> <td data-bbox="836 1845 1070 1930">                       Victoria green RAL 180 30 10                 </td> </tr> <tr> <td data-bbox="596 1937 831 2022">                       Night Red SIKKENS C0.20.20                 </td> <td data-bbox="836 1937 1070 2022">                       Blackblue SIKKENS U0.10.20                 </td> </tr> <tr> <td data-bbox="596 2029 831 2096">                       Jade, pastel RAL 7032                 </td> <td data-bbox="836 2029 1070 2096">                       live simple! No. 8                 </td> </tr> </tbody> </table>		 Sealbrown RAL 8019	 Cristal red SIKKENS C0.60.30	 Savona green SIKKENS K0.05.47	 Victoria green RAL 180 30 10	 Night Red SIKKENS C0.20.20	 Blackblue SIKKENS U0.10.20	 Jade, pastel RAL 7032	 live simple! No. 8
 Sealbrown RAL 8019	 Cristal red SIKKENS C0.60.30									
 Savona green SIKKENS K0.05.47	 Victoria green RAL 180 30 10									
 Night Red SIKKENS C0.20.20	 Blackblue SIKKENS U0.10.20									
 Jade, pastel RAL 7032	 live simple! No. 8									





**XL 49462**

**Front decor** Art Pepper  
(rear in same colour)  
**Surface** velvet lacquer with wood texture  
**Front thickness** 19 mm  
**Door shape** 14,054 kg/sqm excluding handle weight (see handles)  
 coffered front, frame width 75 mm  
**Front material** MDF substrate with high-quality lacquered surface

**Note:**  
 Width 15 cm is supplied with smooth fronts  
 Width 20 cm is supplied with smooth fronts

**Available glass doors for specific models**



**Framed glass door...**  
 e.g. HG 50 78 34 RA



**Framed glass door...**  
 e.g. HGS 50 78 34



**Framed glass door.../ crossbar**  
 e.g. HGKS 50 78 34

**Reference carcase**

**K230P**  
 Art Pepper

**Visible sides**

**R230H**  
 Art Pepper

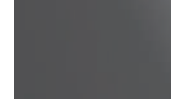
**Available glass versions**



90 clear glass



92 matt glass

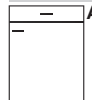


93 black glass

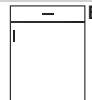


88 Linea glass

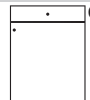
**Available handle arrangements**



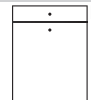
**A**



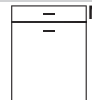
**B\***



**C**



**D**



**M**

\* = Standard finish

**Grip ledges**



N 400, N 475,  
 N 485,  
 N 700, N 775  
 N 900 N 975,

**Handles**



M330 M330

**cornices / light pelmets**

**Front decor** snow white  
**Surface** velvet lacquer with wood texture



**XL 49446**

**Reference carcass**  
**K160F**  
 Snow white

**Visible sides**  
**R160H**  
 Snow White

**Front decor** Light Pepper  
**Surface** velvet lacquer with wood texture



**XL 49448**

**Reference carcass**  
**K218P**  
 Light Pepper

**Visible sides**  
**R218H**  
 Light Pepper

**Front decor** premium white  
**Surface** velvet lacquer with wood texture



**XL 49450**

**Reference carcass**  
**K039P**  
 Premium white

**Visible sides**  
**R039H**  
 Premium white

**Front decor** White Agate  
**Surface** velvet lacquer with wood texture



**XL 49456**

**Reference carcass**  
**K178F**  
 White Agate

**Visible sides**  
**R178H**  
 White Agate

**Front decor** Night Green  
**Surface** velvet lacquer with wood texture



**XL 49459**

**Reference carcass**  
**K075P**  
 Black

**Visible sides**  
**R245H**  
 Night Green

**Front decor** light grey  
**Surface** velvet lacquer with wood texture



**XL 49460**

**Reference carcass**  
**K006P**  
 Light Grey

**Visible sides**  
**R006H**  
 Light Grey

**Front decor** Macaron  
**Surface** velvet lacquer with wood texture



**XL 49465**

**Reference carcass**  
**K076P**  
 Macaron

**Visible sides**  
**R076H**  
 Macaron

**Front decor** Light Nude  
**Surface** velvet lacquer with wood texture



**XL 49466**

**Reference carcass**  
**K248P**  
 Light Nude

**Visible sides**  
**R248H**  
 Light Nude

**Front decor** Fango  
**Surface** velvet lacquer with wood texture



**XL 49467**

**Reference carcass**  
**K263P**  
 Fango

**Visible sides**  
**R263H**  
 Fango

**Front decor** magic grey  
**Surface** velvet lacquer with wood texture



**XL 49484**

**Reference carcass**  
**K058P**  
 Magic-grey

**Visible sides**  
**R058H**  
 Magic-grey

**Front decor** graphite black  
**Surface** velvet lacquer with wood texture



**XL 49495**

**Reference carcass**  
**K043P**  
 Graphite Black

**Visible sides**  
**R043H**  
 Graphite Black

**Front decor** black  
**Surface** velvet lacquer with wood texture



**XL 49498**

**Reference carcass**  
**K075P**  
 Black

**Visible sides**  
**R075H**  
 Black

**Front decor** special colour  
**Surface** velvet lacquer with wood texture











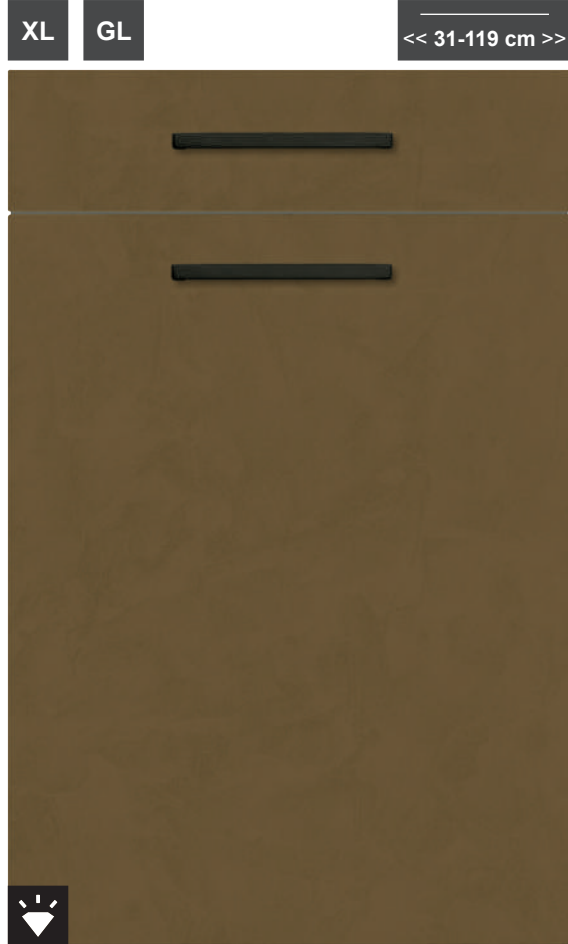
**XL 49499**

**Reference carcass**  
**K023P**  
 Stainless Steel Colour

**Visible sides**  
**R099H**  
 special colour

**Colour concept at no extra charge**

 Sealbrown RAL 8019	 Cristal red SIKKENS C0.60.30
 Savona green SIKKENS K0.05.47	 Victoria green RAL 180 30 10
 Night Red SIKKENS C0.20.20	 Blackblue SIKKENS U0.10.20
 Jade, pastel RAL 7032	 live simple! No. 8



**XL 4370**

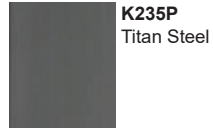
**Front decor** Bronze Metallic  
(rear in same colour)  
**Surface** Velvet lacquer textured  
**Front thickness** 19 mm  
**Door shape** 14,054 kg/sqm excluding handle weight (see handles)  
 Coffered door, rounded on all sides, radius 2 mm  
**Front material** MDF substrate with high-quality lacquered surface

**Available glass doors for specific models**

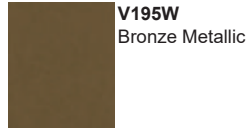


**Framed glass door...**  
e.g. HG 50 78 34 RA

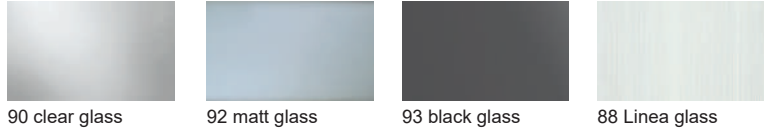
**Reference carcase**



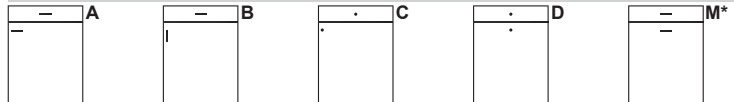
**Visible sides**



**Available glass versions**

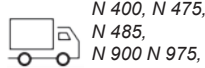


**Available handle arrangements**



\* = Standard finish

**Grip ledges**



**Handles**

**cornices / light pelmets**



KL 105

LB 101

**Front decor** Basalt Metallic  
**Surface** Velvet lacquer textured



**XL 4372**

**Reference carcass**  
**K235P**  
 Titan Steel

**Visible sides**  
**V246W**  
 Basalt Metallic

**Front decor** Silver Metallic  
**Surface** Velvet lacquer textured

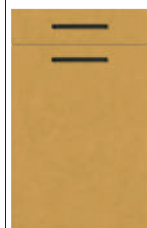


**XL 4374**

**Reference carcass**  
**K235P**  
 Titan Steel

**Visible sides**  
**V182W**  
 Silver Metallic

**Front decor** Gold Metallic  
**Surface** Velvet lacquer textured



**XL 4376**

**Reference carcass**  
**K235P**  
 Titan Steel

**Visible sides**  
**V183W**  
 Gold Metallic

**Front decor** Copper Metallic  
**Surface** Velvet lacquer textured



**XL 4378**

**Reference carcass**  
**K235P**  
 Titan Steel

**Visible sides**  
**V194W**  
 Copper Metallic

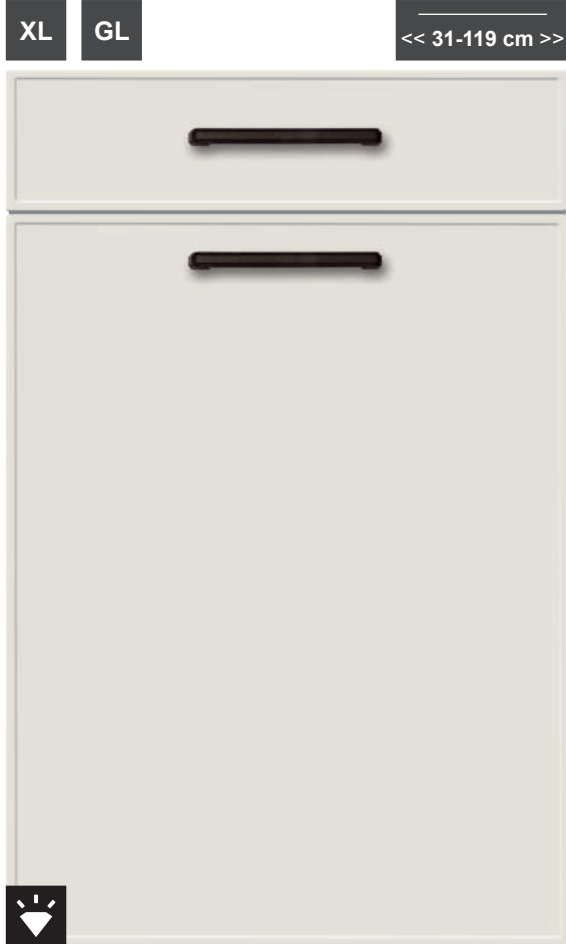
**Front decor** Titan Metallic  
**Surface** Velvet lacquer textured



**XL 4380**

**Reference carcass**  
**K235P**  
 Titan Steel

**Visible sides**  
**V235W**  
 Titan Steel Metallic



**XL 53056**

**Front decor** White Agate  
(rear in same colour)

**Surface** Micro textured lacquer

**Front thickness** 19 mm

**Door shape** 14,04 kg/sqm excluding handle weight (see handles)  
framed front, frame width 12 mm, frame angled 67.5° to the inside

**Front material** MDF substrate with high-quality lacquered surface

**NEW**

**Note:**  
Range always without tightening fitting!

**Available glass doors for specific models**



Framed glass door...  
e.g. HG 50 78 34 RA

**Reference carcase**

**K178F**  
White Agate

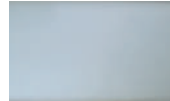
**Visible sides**

**S178P**  
White Agate

**Available glass versions**



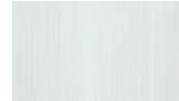
90 clear glass



92 matt glass

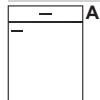


93 black glass



88 Linea glass

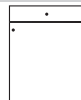
**Available handle arrangements**



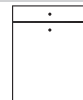
**A**



**B**



**C**



**D**



**M\***

\* = Standard finish

**Grip ledges**



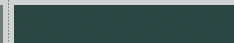
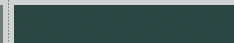
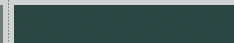
~~N 400, N 475,  
N 485,  
N 900 N 975,  
N 700, N 775~~

**Handles**



~~M330  
M340  
G320  
G321  
G370  
G371  
G024~~

**cornices / light pelmets**

<p><b>Front decor</b> snow white</p> <p><b>Surface</b> Micro textured lacquer</p>  <p><b>XL 53046</b></p> <p><b>Reference carcass</b> K160F Snow white</p> <p><b>Visible sides</b> S160P Snow White</p>	<p><b>Front decor</b> premium white</p> <p><b>Surface</b> Micro textured lacquer</p>  <p><b>XL 53050</b></p> <p><b>Reference carcass</b> K039P Premium white</p> <p><b>Visible sides</b> S039P Premium white</p>	<p><b>Front decor</b> Night Green</p> <p><b>Surface</b> Micro textured lacquer</p>  <p><b>XL 53059</b></p> <p><b>Reference carcass</b> K075P Black</p> <p><b>Visible sides</b> S245P Night Green</p>								
<p><b>Front decor</b> light grey</p> <p><b>Surface</b> Micro textured lacquer</p>  <p><b>XL 53060</b></p> <p><b>Reference carcass</b> K006P Light Grey</p> <p><b>Visible sides</b> S006P Light Grey</p>	<p><b>Front decor</b> Art Pepper</p> <p><b>Surface</b> Micro textured lacquer</p>  <p><b>XL 53062</b></p> <p><b>Reference carcass</b> K230P Art Pepper</p> <p><b>Visible sides</b> S230P Art Pepper</p>	<p><b>Front decor</b> Macaron</p> <p><b>Surface</b> Micro textured lacquer</p>  <p><b>XL 53065</b></p> <p><b>Reference carcass</b> K076P Macaron</p> <p><b>Visible sides</b> S076P Macaron</p>								
<p><b>Front decor</b> Light Nude</p> <p><b>Surface</b> Micro textured lacquer</p>  <p><b>XL 53066</b></p> <p><b>Reference carcass</b> K248P Light Nude</p> <p><b>Visible sides</b> S248P Light Nude</p>	<p><b>Front decor</b> Fango</p> <p><b>Surface</b> Micro textured lacquer</p>  <p><b>XL 53067</b></p> <p><b>Reference carcass</b> K263P Fango</p> <p><b>Visible sides</b> S263P Fango</p>	<p><b>Front decor</b> Light Pepper</p> <p><b>Surface</b> Micro textured lacquer</p>  <p><b>XL 53069</b></p> <p><b>Reference carcass</b> K218P Light Pepper</p> <p><b>Visible sides</b> S218P Light Pepper</p>								
<p><b>Front decor</b> magic grey</p> <p><b>Surface</b> Micro textured lacquer</p>  <p><b>XL 53084</b></p> <p><b>Reference carcass</b> K058P Magic-grey</p> <p><b>Visible sides</b> S058P Magic-grey</p>	<p><b>Front decor</b> graphite black</p> <p><b>Surface</b> Micro textured lacquer</p>  <p><b>XL 53095</b></p> <p><b>Reference carcass</b> K043P Graphite Black</p> <p><b>Visible sides</b> S043P Graphite Black</p>	<p><b>Front decor</b> black</p> <p><b>Surface</b> Micro textured lacquer</p>  <p><b>XL 53098</b></p> <p><b>Reference carcass</b> K075P Black</p> <p><b>Visible sides</b> S075P Black</p>								
<p><b>Front decor</b> special colour</p> <p><b>Surface</b> Micro textured lacquer</p>  <p><b>XL 53099</b></p> <p><b>Reference carcass</b> K023P Stainless Steel Colour</p> <p><b>Visible sides</b> S099P special colour</p>	<p style="text-align: center;"><b>Colour concept at no extra charge</b></p> <table border="1"> <tbody> <tr> <td data-bbox="593 1751 826 1839">  Sealbrown RAL 8019                 </td> <td data-bbox="826 1751 1061 1839">  Cristal red SIKKENS C0.60.30                 </td> </tr> <tr> <td data-bbox="593 1839 826 1926">  Savona green SIKKENS K0.05.47                 </td> <td data-bbox="826 1839 1061 1926">  Victoria green RAL 180 30 10                 </td> </tr> <tr> <td data-bbox="593 1926 826 2013">  Night Red SIKKENS C0.20.20                 </td> <td data-bbox="826 1926 1061 2013">  Blackblue SIKKENS U0.10.20                 </td> </tr> <tr> <td data-bbox="593 2013 826 2096">  Jade, pastel RAL 7032                 </td> <td data-bbox="826 2013 1061 2096">  live simple! No. 8                 </td> </tr> </tbody> </table>		 Sealbrown RAL 8019	 Cristal red SIKKENS C0.60.30	 Savona green SIKKENS K0.05.47	 Victoria green RAL 180 30 10	 Night Red SIKKENS C0.20.20	 Blackblue SIKKENS U0.10.20	 Jade, pastel RAL 7032	 live simple! No. 8
 Sealbrown RAL 8019	 Cristal red SIKKENS C0.60.30									
 Savona green SIKKENS K0.05.47	 Victoria green RAL 180 30 10									
 Night Red SIKKENS C0.20.20	 Blackblue SIKKENS U0.10.20									
 Jade, pastel RAL 7032	 live simple! No. 8									



**XL 54056**

**Front decor** White Agate  
(rear in same colour)

**Surface** Velvet lacquer

**Front thickness** 19 mm

**Door shape** 14,04 kg/sqm excluding handle weight (see handles)  
framed front, frame width 12 mm, frame angled 67.5° to the inside

**Front material** MDF substrate with high-quality lacquered surface

**NEW**

Range always without tightening fitting!

Available glass doors for specific models



Framed glass door...  
e.g. HG 50 78 34 RA

Reference carcase

**K178F**  
White Agate

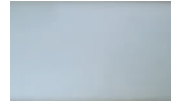
Visible sides

**B178F**  
White Agate

Available glass versions



90 clear glass



92 matt glass

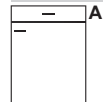


93 black glass



88 Linea glass

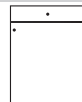
Available handle arrangements



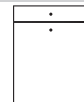
A



B



C



D



M\*

\* = Standard finish

Grip ledges



N 400, N 475,  
N 485,  
N 900 N 975,  
N 700, N 775

Handles



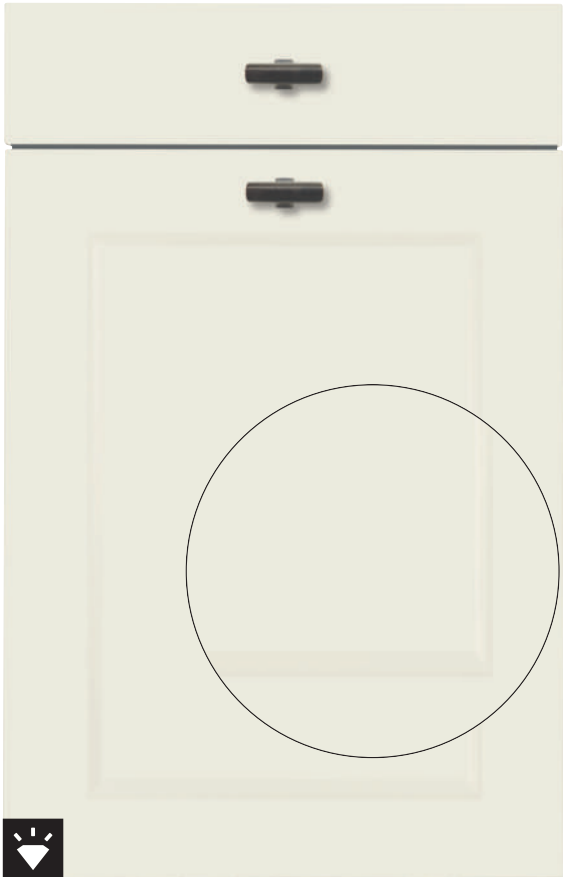
M330  
M340  
G320  
G321  
G370  
G371  
G024

cornices / light pelmets



<p><b>Front decor</b> snow white</p> <p><b>Surface</b> Velvet lacquer</p>  <p><b>XL 54046</b></p> <p><b>Reference carcass</b> K160F Snow white</p> <p><b>Visible sides</b> B160F Snow White</p>	<p><b>Front decor</b> premium white</p> <p><b>Surface</b> Velvet lacquer</p>  <p><b>XL 54050</b></p> <p><b>Reference carcass</b> K039P Premium white</p> <p><b>Visible sides</b> B039F Premium white</p>	<p><b>Front decor</b> Night Green</p> <p><b>Surface</b> Velvet lacquer</p>  <p><b>XL 54059</b></p> <p><b>Reference carcass</b> K075P Black</p> <p><b>Visible sides</b> B245F Night Green</p>								
<p><b>Front decor</b> light grey</p> <p><b>Surface</b> Velvet lacquer</p>  <p><b>XL 54060</b></p> <p><b>Reference carcass</b> K006P Light Grey</p> <p><b>Visible sides</b> B006F Light Grey</p>	<p><b>Front decor</b> Art Pepper</p> <p><b>Surface</b> Velvet lacquer</p>  <p><b>XL 54062</b></p> <p><b>Reference carcass</b> K230P Art Pepper</p> <p><b>Visible sides</b> B230F Art Pepper</p>	<p><b>Front decor</b> Macaron</p> <p><b>Surface</b> Velvet lacquer</p>  <p><b>XL 54065</b></p> <p><b>Reference carcass</b> K076P Macaron</p> <p><b>Visible sides</b> B076F Macaron</p>								
<p><b>Front decor</b> Light Nude</p> <p><b>Surface</b> Velvet lacquer</p>  <p><b>XL 54066</b></p> <p><b>Reference carcass</b> K248P Light Nude</p> <p><b>Visible sides</b> B248F Light Nude</p>	<p><b>Front decor</b> Fango</p> <p><b>Surface</b> Velvet lacquer</p>  <p><b>XL 54067</b></p> <p><b>Reference carcass</b> K263P Fango</p> <p><b>Visible sides</b> B263F Fango</p>	<p><b>Front decor</b> Light Pepper</p> <p><b>Surface</b> Velvet lacquer</p>  <p><b>XL 54069</b></p> <p><b>Reference carcass</b> K218P Light Pepper</p> <p><b>Visible sides</b> B218F Light Pepper</p>								
<p><b>Front decor</b> magic grey</p> <p><b>Surface</b> Velvet lacquer</p>  <p><b>XL 54084</b></p> <p><b>Reference carcass</b> K058P Magic-grey</p> <p><b>Visible sides</b> B058F Magic-grey</p>	<p><b>Front decor</b> graphite black</p> <p><b>Surface</b> Velvet lacquer</p>  <p><b>XL 54095</b></p> <p><b>Reference carcass</b> K043P Graphite Black</p> <p><b>Visible sides</b> B043F Graphite Black</p>	<p><b>Front decor</b> black</p> <p><b>Surface</b> Velvet lacquer</p>  <p><b>XL 54098</b></p> <p><b>Reference carcass</b> K075P Black</p> <p><b>Visible sides</b> B075F Black</p>								
<p><b>Front decor</b> special colour</p> <p><b>Surface</b> Velvet lacquer</p>  <p><b>XL 54099</b></p> <p><b>Reference carcass</b> K023P Stainless Steel Colour</p> <p><b>Visible sides</b> B099F special colour</p>	<p style="text-align: center;"><b>Colour concept at no extra charge</b></p> <table border="1"> <tbody> <tr> <td data-bbox="593 1751 829 1839">  Sealbrown RAL 8019                 </td> <td data-bbox="829 1751 1061 1839">  Cristal red SIKKENS C0.60.30                 </td> </tr> <tr> <td data-bbox="593 1839 829 1926">  Savona green SIKKENS K0.05.47                 </td> <td data-bbox="829 1839 1061 1926">  Victoria green RAL 180 30 10                 </td> </tr> <tr> <td data-bbox="593 1926 829 2013">  Night Red SIKKENS C0.20.20                 </td> <td data-bbox="829 1926 1061 2013">  Blackblue SIKKENS U0.10.20                 </td> </tr> <tr> <td data-bbox="593 2013 829 2096">  Jade, pastel RAL 7032                 </td> <td data-bbox="829 2013 1061 2096">  live simple! No. 8                 </td> </tr> </tbody> </table>		 Sealbrown RAL 8019	 Cristal red SIKKENS C0.60.30	 Savona green SIKKENS K0.05.47	 Victoria green RAL 180 30 10	 Night Red SIKKENS C0.20.20	 Blackblue SIKKENS U0.10.20	 Jade, pastel RAL 7032	 live simple! No. 8
 Sealbrown RAL 8019	 Cristal red SIKKENS C0.60.30									
 Savona green SIKKENS K0.05.47	 Victoria green RAL 180 30 10									
 Night Red SIKKENS C0.20.20	 Blackblue SIKKENS U0.10.20									
 Jade, pastel RAL 7032	 live simple! No. 8									

**XL** **GL** << 31-119 cm >>



**XL 5150**

**Front decor** premium white  
(rear in same colour)  
**Surface** Micro textured lacquer  
**Front thickness** 22 mm  
**Door shape** 15,135 kg/sqm excluding handle weight (see handles)  
framed front, with angled interior profile, frame width 83 mm  
**Front material** MDF substrate with high-quality lacquered surface

**Note:**  
Width 15 cm is supplied with smooth fronts  
Range always without tightening fitting!

**Available glass doors for specific models**



**Framed glass door...**  
e.g. HG 50 78 34 RA



**Framed glass door...**  
e.g. HGS 50 78 34



**Framed glass door.../ crossbar**  
e.g. HGKS 50 78 34

**Reference carcass**

**K039P**  
Premium white

**Visible sides**

**S039P**  
Premium white

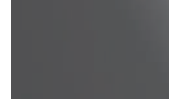
**Available glass versions**



90 clear glass



92 matt glass

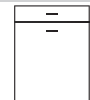
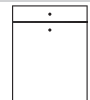
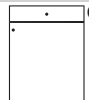
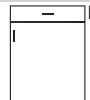


93 black glass



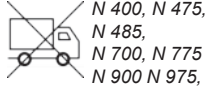
88 Linea glass

**Available handle arrangements**



\* = Standard finish

**Grip ledges**



N 400, N 475,  
N 485,  
N 700, N 775  
N 900 N 975,

**Handles**



M330 M340







**cornices / light pelmets**



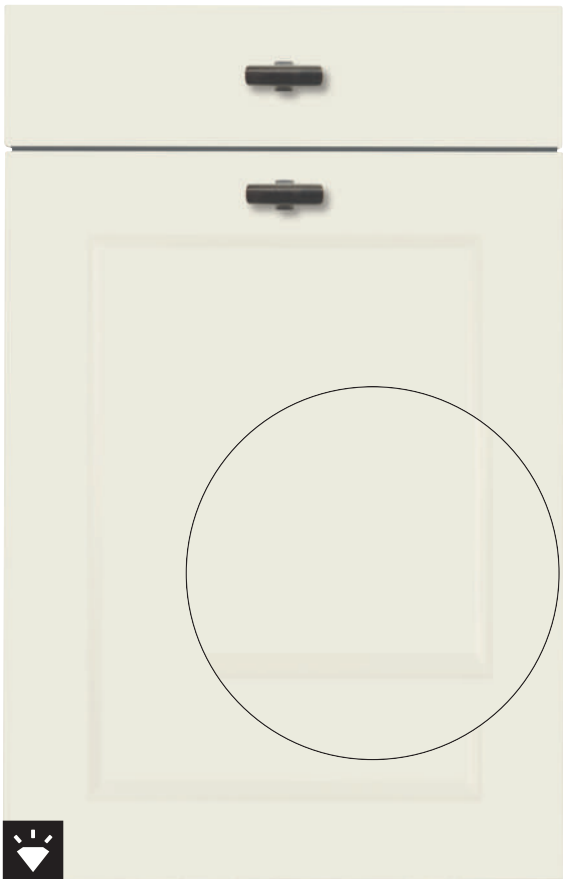
KL 105



LB 101

<p><b>Front decor</b> snow white</p> <p><b>Surface</b> Micro textured lacquer</p>  <p><b>XL 5146</b></p> <p><b>Reference carcass</b> K160F Snow white</p> <p><b>Visible sides</b> S160P Snow White</p>	<p><b>Front decor</b> White Agate</p> <p><b>Surface</b> Micro textured lacquer</p>  <p><b>XL 5156</b></p> <p><b>Reference carcass</b> K178F White Agate</p> <p><b>Visible sides</b> S178P White Agate</p>	<p><b>Front decor</b> Night Green</p> <p><b>Surface</b> Micro textured lacquer</p>  <p><b>XL 5159</b></p> <p><b>Reference carcass</b> K075P Black</p> <p><b>Visible sides</b> S245P Night Green</p>								
<p><b>Front decor</b> light grey</p> <p><b>Surface</b> Micro textured lacquer</p>  <p><b>XL 5160</b></p> <p><b>Reference carcass</b> K006P Light Grey</p> <p><b>Visible sides</b> S006P Light Grey</p>	<p><b>Front decor</b> Art Pepper</p> <p><b>Surface</b> Micro textured lacquer</p>  <p><b>XL 5161</b></p> <p><b>Reference carcass</b> K230P Art Pepper</p> <p><b>Visible sides</b> S230P Art Pepper</p>	<p><b>Front decor</b> Macaron</p> <p><b>Surface</b> Micro textured lacquer</p>  <p><b>XL 5165</b></p> <p><b>Reference carcass</b> K076P Macaron</p> <p><b>Visible sides</b> S076P Macaron</p>								
<p><b>Front decor</b> Light Nude</p> <p><b>Surface</b> Micro textured lacquer</p>  <p><b>XL 5166</b></p> <p><b>Reference carcass</b> K248P Light Nude</p> <p><b>Visible sides</b> S248P Light Nude</p>	<p><b>Front decor</b> Fango</p> <p><b>Surface</b> Micro textured lacquer</p>  <p><b>XL 5167</b></p> <p><b>Reference carcass</b> K263P Fango</p> <p><b>Visible sides</b> S263P Fango</p>	<p><b>Front decor</b> Light Pepper</p> <p><b>Surface</b> Micro textured lacquer</p>  <p><b>XL 5169</b></p> <p><b>Reference carcass</b> K218P Light Pepper</p> <p><b>Visible sides</b> S218P Light Pepper</p>								
<p><b>Front decor</b> magic grey</p> <p><b>Surface</b> Micro textured lacquer</p>  <p><b>XL 5184</b></p> <p><b>Reference carcass</b> K058P Magic-grey</p> <p><b>Visible sides</b> S058P Magic-grey</p>	<p><b>Front decor</b> graphite black</p> <p><b>Surface</b> Micro textured lacquer</p>  <p><b>XL 5195</b></p> <p><b>Reference carcass</b> K043P Graphite Black</p> <p><b>Visible sides</b> S043P Graphite Black</p>	<p><b>Front decor</b> black</p> <p><b>Surface</b> Micro textured lacquer</p>  <p><b>XL 5198</b></p> <p><b>Reference carcass</b> K075P Black</p> <p><b>Visible sides</b> S075P Black</p>								
<p><b>Front decor</b> special colour</p> <p><b>Surface</b> Micro textured lacquer</p>  <p><b>XL 5199</b></p> <p><b>Reference carcass</b> K023P Stainless Steel Colour</p> <p><b>Visible sides</b> S099P special colour</p>	<p style="text-align: center;"><b>Colour concept at no extra charge</b></p> <table border="1"> <tbody> <tr> <td data-bbox="596 1749 831 1839">  Sealbrown RAL 8019                 </td> <td data-bbox="836 1749 1066 1839">  Cristal red SIKKENS C0.60.30                 </td> </tr> <tr> <td data-bbox="596 1845 831 1935">  Savona green SIKKENS K0.05.47                 </td> <td data-bbox="836 1845 1066 1935">  Victoria green RAL 180 30 10                 </td> </tr> <tr> <td data-bbox="596 1942 831 2031">  Night Red SIKKENS C0.20.20                 </td> <td data-bbox="836 1942 1066 2031">  Blackblue SIKKENS U0.10.20                 </td> </tr> <tr> <td data-bbox="596 2038 831 2096">  Jade, pastel RAL 7032                 </td> <td data-bbox="836 2038 1066 2096">  live simple! No. 8                 </td> </tr> </tbody> </table>		 Sealbrown RAL 8019	 Cristal red SIKKENS C0.60.30	 Savona green SIKKENS K0.05.47	 Victoria green RAL 180 30 10	 Night Red SIKKENS C0.20.20	 Blackblue SIKKENS U0.10.20	 Jade, pastel RAL 7032	 live simple! No. 8
 Sealbrown RAL 8019	 Cristal red SIKKENS C0.60.30									
 Savona green SIKKENS K0.05.47	 Victoria green RAL 180 30 10									
 Night Red SIKKENS C0.20.20	 Blackblue SIKKENS U0.10.20									
 Jade, pastel RAL 7032	 live simple! No. 8									

**XL** **GL** << 31-119 cm >>



**XL 5550**

**Front decor** premium white (rear in same colour)  
**Surface** Velvet lacquer  
**Front thickness** 22 mm  
**Door shape** 15,135 kg/sqm excluding handle weight (see handles) framed front, with angled interior profile, frame width 83 mm  
**Front material** MDF substrate with high-quality lacquered surface

**Note:**  
 Width 15 cm is supplied with smooth fronts  
 Range always without tightening fitting!

**Available glass doors for specific models**



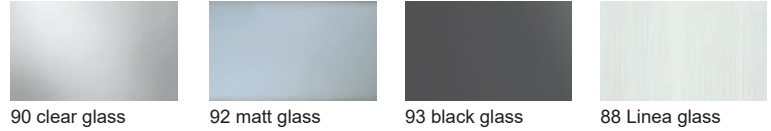
**Reference carcass**

**K039P**  
Premium white

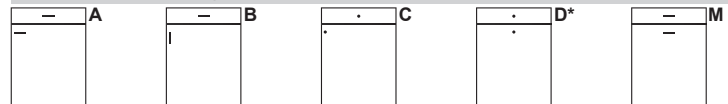
**Visible sides**

**B039F**  
Premium white

**Available glass versions**



**Available handle arrangements**



\* = Standard finish

**Grip ledges**




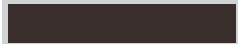




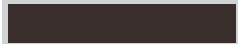




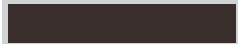




N 400, N 475,  
N 485,  
N 900 N 975,  
N 700, N 775

**Handles**

~~M330 M340~~

**cornices / light pelmets**

   
**KL 105**    **LB 101**

<p><b>Front decor</b> snow white</p> <p><b>Surface</b> Velvet lacquer</p>  <p><b>XL 5546</b></p> <p><b>Reference carcass</b> K160F Snow white</p> <p><b>Visible sides</b> B160F Snow White</p>	<p><b>Front decor</b> White Agate</p> <p><b>Surface</b> Velvet lacquer</p>  <p><b>XL 5556</b></p> <p><b>Reference carcass</b> K178F White Agate</p> <p><b>Visible sides</b> B178F White Agate</p>	<p><b>Front decor</b> Night Green</p> <p><b>Surface</b> Velvet lacquer</p>  <p><b>XL 5559</b></p> <p><b>Reference carcass</b> K075P Black</p> <p><b>Visible sides</b> B245F Night Green</p>								
<p><b>Front decor</b> Art Pepper</p> <p><b>Surface</b> Velvet lacquer</p>  <p><b>XL 5561</b></p> <p><b>Reference carcass</b> K230P Art Pepper</p> <p><b>Visible sides</b> B230F Art Pepper</p>	<p><b>Front decor</b> Macaron</p> <p><b>Surface</b> Velvet lacquer</p>  <p><b>XL 5565</b></p> <p><b>Reference carcass</b> K076P Macaron</p> <p><b>Visible sides</b> B076F Macaron</p>	<p><b>Front decor</b> Light Nude</p> <p><b>Surface</b> Velvet lacquer</p>  <p><b>XL 5566</b></p> <p><b>Reference carcass</b> K248P Light Nude</p> <p><b>Visible sides</b> B248F Light Nude</p>								
<p><b>Front decor</b> Fango</p> <p><b>Surface</b> Velvet lacquer</p>  <p><b>XL 5567</b></p> <p><b>Reference carcass</b> K263P Fango</p> <p><b>Visible sides</b> B263F Fango</p>	<p><b>Front decor</b> Light Pepper</p> <p><b>Surface</b> Velvet lacquer</p>  <p><b>XL 5569</b></p> <p><b>Reference carcass</b> K218P Light Pepper</p> <p><b>Visible sides</b> B218F Light Pepper</p>	<p><b>Front decor</b> magic grey</p> <p><b>Surface</b> Velvet lacquer</p>  <p><b>XL 5584</b></p> <p><b>Reference carcass</b> K058P Magic-grey</p> <p><b>Visible sides</b> B058F Magic-grey</p>								
<p><b>Front decor</b> light grey</p> <p><b>Surface</b> Velvet lacquer</p>  <p><b>XL 5585</b></p> <p><b>Reference carcass</b> K006P Light Grey</p> <p><b>Visible sides</b> B006F Light Grey</p>	<p><b>Front decor</b> graphite black</p> <p><b>Surface</b> Velvet lacquer</p>  <p><b>XL 5595</b></p> <p><b>Reference carcass</b> K043P Graphite Black</p> <p><b>Visible sides</b> B043F Graphite Black</p>	<p><b>Front decor</b> black</p> <p><b>Surface</b> Velvet lacquer</p>  <p><b>XL 5598</b></p> <p><b>Reference carcass</b> K075P Black</p> <p><b>Visible sides</b> B075F Black</p>								
<p><b>Front decor</b> special colour</p> <p><b>Surface</b> Velvet lacquer</p>  <p><b>XL 5599</b></p> <p><b>Reference carcass</b> K023P Stainless Steel Colour</p> <p><b>Visible sides</b> B099F special colour</p>	<p style="text-align: center;"><b>Colour concept at no extra charge</b></p> <table border="1"> <tbody> <tr> <td data-bbox="592 1751 831 1839">  Sealbrown RAL 8019                 </td> <td data-bbox="836 1751 1066 1839">  Cristal red SIKKENS C0.60.30                 </td> </tr> <tr> <td data-bbox="592 1845 831 1933">  Savona green SIKKENS K0.05.47                 </td> <td data-bbox="836 1845 1066 1933">  Victoria green RAL 180 30 10                 </td> </tr> <tr> <td data-bbox="592 1939 831 2027">  Night Red SIKKENS C0.20.20                 </td> <td data-bbox="836 1939 1066 2027">  Blackblue SIKKENS U0.10.20                 </td> </tr> <tr> <td data-bbox="592 2033 831 2098">  Jade, pastel RAL 7032                 </td> <td data-bbox="836 2033 1066 2098">  live simple! No. 8                 </td> </tr> </tbody> </table>		 Sealbrown RAL 8019	 Cristal red SIKKENS C0.60.30	 Savona green SIKKENS K0.05.47	 Victoria green RAL 180 30 10	 Night Red SIKKENS C0.20.20	 Blackblue SIKKENS U0.10.20	 Jade, pastel RAL 7032	 live simple! No. 8
 Sealbrown RAL 8019	 Cristal red SIKKENS C0.60.30									
 Savona green SIKKENS K0.05.47	 Victoria green RAL 180 30 10									
 Night Red SIKKENS C0.20.20	 Blackblue SIKKENS U0.10.20									
 Jade, pastel RAL 7032	 live simple! No. 8									



**XL 5265**

**Front decor** Macaron  
(rear in same colour)  
**Surface** Micro textured lacquer  
**Front thickness** 19 mm  
**Door shape** 15,135 kg/sqm excluding handle weight (see handles)  
 Modern coffered front with inner profile, frame width 75 mm  
**Front material** MDF substrate with high-quality lacquered surface

**Note:**  
 Width 15 cm is supplied with smooth fronts

**Available glass doors for specific models**



**Framed glass door...**  
 e.g. HG 50 78 34 RA



**Framed glass door...**  
 e.g. HGS 50 78 34



**Framed glass door.../ crossbar**  
 e.g. HGKS 50 78 34

**Reference carcass**

**K076P**  
 Macaron

**Visible sides**

**S076P**  
 Macaron

**Available glass versions**



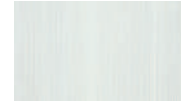
90 clear glass



92 matt glass

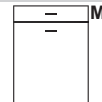
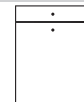
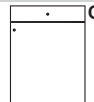


93 black glass



88 Linea glass

**Available handle arrangements**



\* = Standard finish

**Grip ledges**



N 400, N 475,  
 N 485,  
 N 700, N 775  
 N 900 N 975,

**Handles**



M330 M340


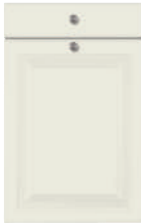








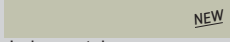
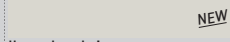


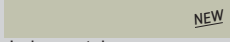
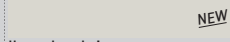


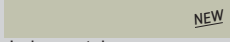
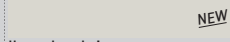
**cornices / light pelmets**



KL 105

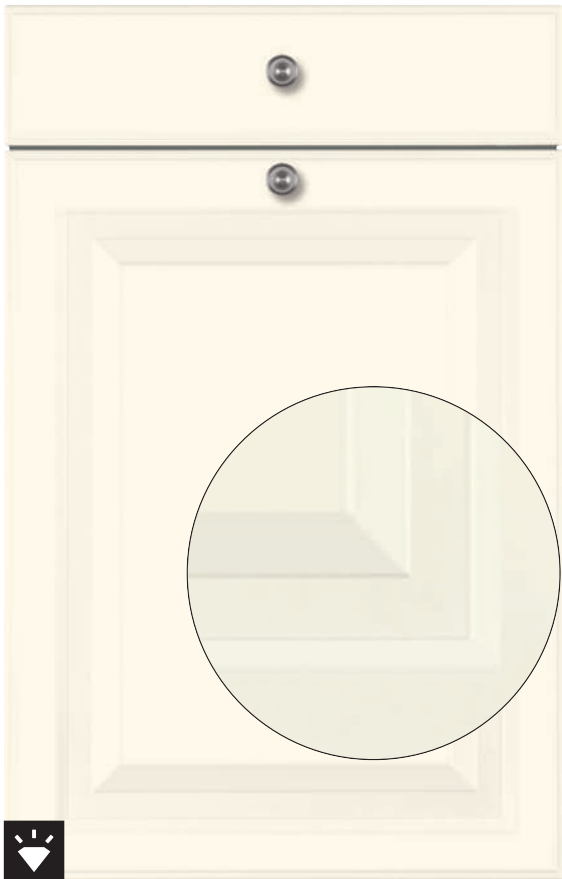


LB 101

<p><b>Front decor</b> snow white</p> <p><b>Surface</b> Micro textured lacquer</p>  <p><b>XL 5246</b></p> <p><b>Reference carcass</b> K160F Snow white</p> <p><b>Visible sides</b> S160P Snow White</p>	<p><b>Front decor</b> premium white</p> <p><b>Surface</b> Micro textured lacquer</p>  <p><b>XL 5250</b></p> <p><b>Reference carcass</b> K039P Premium white</p> <p><b>Visible sides</b> S039P Premium white</p>	<p><b>Front decor</b> White Agate</p> <p><b>Surface</b> Micro textured lacquer</p>  <p><b>XL 5256</b></p> <p><b>Reference carcass</b> K178F White Agate</p> <p><b>Visible sides</b> S178P White Agate</p>								
<p><b>Front decor</b> Night Green</p> <p><b>Surface</b> Micro textured lacquer</p>  <p><b>XL 5259</b></p> <p><b>Reference carcass</b> K075P Black</p> <p><b>Visible sides</b> S245P Night Green</p>	<p><b>Front decor</b> light grey</p> <p><b>Surface</b> Micro textured lacquer</p>  <p><b>XL 5260</b></p> <p><b>Reference carcass</b> K006P Light Grey</p> <p><b>Visible sides</b> S006P Light Grey</p>	<p><b>Front decor</b> Art Pepper</p> <p><b>Surface</b> Micro textured lacquer</p>  <p><b>XL 5261</b></p> <p><b>Reference carcass</b> K230P Art Pepper</p> <p><b>Visible sides</b> S230P Art Pepper</p>								
<p><b>Front decor</b> Light Nude</p> <p><b>Surface</b> Micro textured lacquer</p>  <p><b>XL 5266</b></p> <p><b>Reference carcass</b> K248P Light Nude</p> <p><b>Visible sides</b> S248P Light Nude</p>	<p><b>Front decor</b> Fango</p> <p><b>Surface</b> Micro textured lacquer</p>  <p><b>XL 5267</b></p> <p><b>Reference carcass</b> K263P Fango</p> <p><b>Visible sides</b> S263P Fango</p>	<p><b>Front decor</b> Light Pepper</p> <p><b>Surface</b> Micro textured lacquer</p>  <p><b>XL 5269</b></p> <p><b>Reference carcass</b> K218P Light Pepper</p> <p><b>Visible sides</b> S218P Light Pepper</p>								
<p><b>Front decor</b> magic grey</p> <p><b>Surface</b> Micro textured lacquer</p>  <p><b>XL 5284</b></p> <p><b>Reference carcass</b> K058P Magic-grey</p> <p><b>Visible sides</b> S058P Magic-grey</p>	<p><b>Front decor</b> graphite black</p> <p><b>Surface</b> Micro textured lacquer</p>  <p><b>XL 5295</b></p> <p><b>Reference carcass</b> K043P Graphite Black</p> <p><b>Visible sides</b> S043P Graphite Black</p>	<p><b>Front decor</b> black</p> <p><b>Surface</b> Micro textured lacquer</p>  <p><b>XL 5298</b></p> <p><b>Reference carcass</b> K075P Black</p> <p><b>Visible sides</b> S075P Black</p>								
<p><b>Front decor</b> special colour</p> <p><b>Surface</b> Micro textured lacquer</p>  <p><b>XL 5299</b></p> <p><b>Reference carcass</b> K023P Stainless Steel Colour</p> <p><b>Visible sides</b> S099P special colour</p>	<p style="text-align: center;"><b>Colour concept at no extra charge</b></p> <table border="1" style="width: 100%; border-collapse: collapse;"> <tbody> <tr> <td style="width: 50%; padding: 5px;">                       Sealbrown RAL 8019                 </td> <td style="width: 50%; padding: 5px;">                       Cristal red SIKKENS C0.60.30                 </td> </tr> <tr> <td style="padding: 5px;">                       Savona green SIKKENS K0.05.47                 </td> <td style="padding: 5px;">                       Victoria green RAL 180 30 10                 </td> </tr> <tr> <td style="padding: 5px;">                       Night Red SIKKENS C0.20.20                 </td> <td style="padding: 5px;">                       Blackblue SIKKENS U0.10.20                 </td> </tr> <tr> <td style="padding: 5px;">                       Jade, pastel RAL 7032                 </td> <td style="padding: 5px;">                       live simple! No. 8                 </td> </tr> </tbody> </table>		 Sealbrown RAL 8019	 Cristal red SIKKENS C0.60.30	 Savona green SIKKENS K0.05.47	 Victoria green RAL 180 30 10	 Night Red SIKKENS C0.20.20	 Blackblue SIKKENS U0.10.20	 Jade, pastel RAL 7032	 live simple! No. 8
 Sealbrown RAL 8019	 Cristal red SIKKENS C0.60.30									
 Savona green SIKKENS K0.05.47	 Victoria green RAL 180 30 10									
 Night Red SIKKENS C0.20.20	 Blackblue SIKKENS U0.10.20									
 Jade, pastel RAL 7032	 live simple! No. 8									



**XL** **GL** << 31-119 cm >>



**XL 5765**

**Front decor** Macaron  
(rear in same colour)  
**Surface** Velvet lacquer  
**Front thickness** 19 mm  
**Door shape** 15,135 kg/sqm excluding handle weight (see handles)  
 Modern coffered front with inner profile, frame width 75 mm  
**Front material** MDF substrate with high-quality lacquered surface

**Note:**  
 Width 15 cm is supplied with smooth fronts

**Reference carcass**

**K076P**  
 Macaron

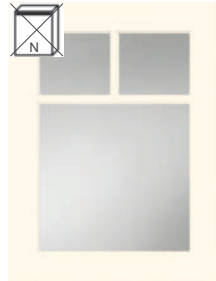
**Visible sides**

**B076F**  
 Macaron

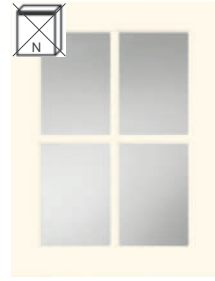
**Available glass doors for specific models**



**Framed glass door...**  
 e.g. HG 50 78 34 RA



**Framed glass door...**  
 e.g. HGS 50 78 34



**Framed glass door.../ crossbar**  
 e.g. HGKS 50 78 34

**Available glass versions**



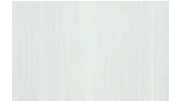
90 clear glass



92 matt glass



93 black glass



88 Linea glass

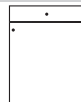
**Available handle arrangements**



**A**



**B**



**C**



**D\***



**M**

\* = Standard finish

**Grip ledges**



N 400, N 475,  
 N 485,  
 N 700, N 775  
 N 900 N 975,

**Handles**



M330 M340








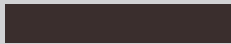
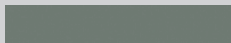
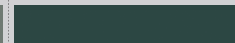

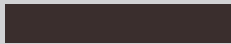
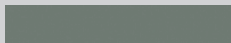
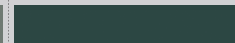

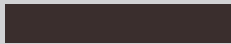
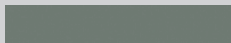
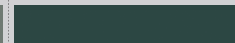

**cornices / light pelmets**

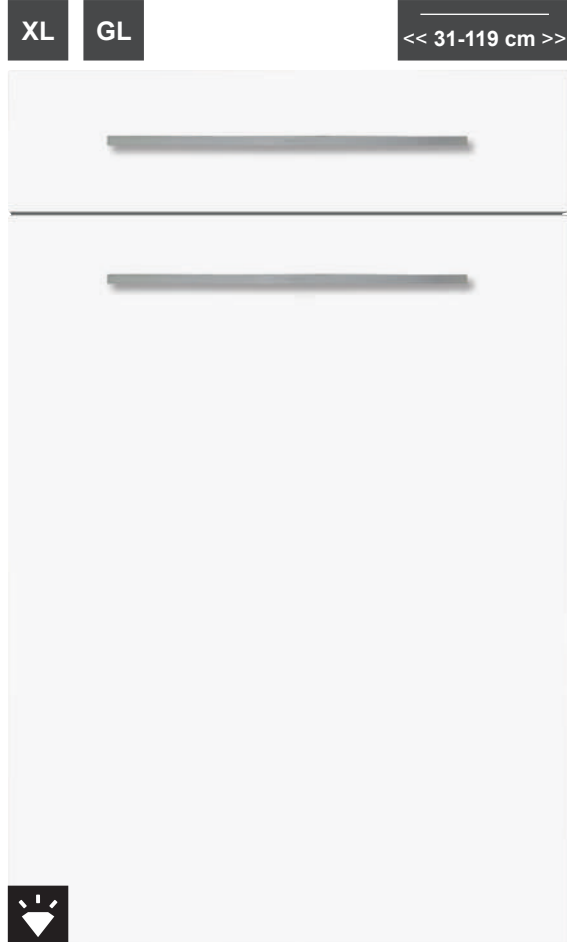


KL 105



LB 101

<p><b>Front decor</b> snow white</p> <p><b>Surface</b> Velvet lacquer</p>  <p><b>XL 5746</b></p> <p><b>Reference carcass</b> K160F Snow white</p> <p><b>Visible sides</b> B160F Snow White</p>	<p><b>Front decor</b> premium white</p> <p><b>Surface</b> Velvet lacquer</p>  <p><b>XL 5750</b></p> <p><b>Reference carcass</b> K039P Premium white</p> <p><b>Visible sides</b> B039F Premium white</p>	<p><b>Front decor</b> White Agate</p> <p><b>Surface</b> Velvet lacquer</p>  <p><b>XL 5756</b></p> <p><b>Reference carcass</b> K178F White Agate</p> <p><b>Visible sides</b> B178F White Agate</p>								
<p><b>Front decor</b> Night Green</p> <p><b>Surface</b> Velvet lacquer</p>  <p><b>XL 5759</b></p> <p><b>Reference carcass</b> K075P Black</p> <p><b>Visible sides</b> B245F Night Green</p>	<p><b>Front decor</b> Art Pepper</p> <p><b>Surface</b> Velvet lacquer</p>  <p><b>XL 5761</b></p> <p><b>Reference carcass</b> K230P Art Pepper</p> <p><b>Visible sides</b> B230F Art Pepper</p>	<p><b>Front decor</b> Light Nude</p> <p><b>Surface</b> Velvet lacquer</p>  <p><b>XL 5766</b></p> <p><b>Reference carcass</b> K248P Light Nude</p> <p><b>Visible sides</b> B248F Light Nude</p>								
<p><b>Front decor</b> Fango</p> <p><b>Surface</b> Velvet lacquer</p>  <p><b>XL 5767</b></p> <p><b>Reference carcass</b> K263P Fango</p> <p><b>Visible sides</b> B263F Fango</p>	<p><b>Front decor</b> Light Pepper</p> <p><b>Surface</b> Velvet lacquer</p>  <p><b>XL 5769</b></p> <p><b>Reference carcass</b> K218P Light Pepper</p> <p><b>Visible sides</b> B218F Light Pepper</p>	<p><b>Front decor</b> magic grey</p> <p><b>Surface</b> Velvet lacquer</p>  <p><b>XL 5784</b></p> <p><b>Reference carcass</b> K058P Magic-grey</p> <p><b>Visible sides</b> B058F Magic-grey</p>								
<p><b>Front decor</b> light grey</p> <p><b>Surface</b> Velvet lacquer</p>  <p><b>XL 5785</b></p> <p><b>Reference carcass</b> K006P Light Grey</p> <p><b>Visible sides</b> B006F Light Grey</p>	<p><b>Front decor</b> graphite black</p> <p><b>Surface</b> Velvet lacquer</p>  <p><b>XL 5795</b></p> <p><b>Reference carcass</b> K043P Graphite Black</p> <p><b>Visible sides</b> B043F Graphite Black</p>	<p><b>Front decor</b> black</p> <p><b>Surface</b> Velvet lacquer</p>  <p><b>XL 5798</b></p> <p><b>Reference carcass</b> K075P Black</p> <p><b>Visible sides</b> B075F Black</p>								
<p><b>Front decor</b> special colour</p> <p><b>Surface</b> Velvet lacquer</p>  <p><b>XL 5799</b></p> <p><b>Reference carcass</b> K023P Stainless Steel Colour</p> <p><b>Visible sides</b> B099F special colour</p>	<p style="text-align: center;"><b>Colour concept at no extra charge</b></p> <table border="1"> <tbody> <tr> <td data-bbox="595 1751 826 1839">  Sealbrown RAL 8019                 </td> <td data-bbox="826 1751 1062 1839">  Cristal red SIKKENS C0.60.30                 </td> </tr> <tr> <td data-bbox="595 1839 826 1926">  Savona green SIKKENS K0.05.47                 </td> <td data-bbox="826 1839 1062 1926">  Victoria green RAL 180 30 10                 </td> </tr> <tr> <td data-bbox="595 1926 826 2013">  Night Red SIKKENS C0.20.20                 </td> <td data-bbox="826 1926 1062 2013">  Blackblue SIKKENS U0.10.20                 </td> </tr> <tr> <td data-bbox="595 2013 826 2096">  Jade, pastel RAL 7032                 </td> <td data-bbox="826 2013 1062 2096">  live simple! No. 8                 </td> </tr> </tbody> </table>		 Sealbrown RAL 8019	 Cristal red SIKKENS C0.60.30	 Savona green SIKKENS K0.05.47	 Victoria green RAL 180 30 10	 Night Red SIKKENS C0.20.20	 Blackblue SIKKENS U0.10.20	 Jade, pastel RAL 7032	 live simple! No. 8
 Sealbrown RAL 8019	 Cristal red SIKKENS C0.60.30									
 Savona green SIKKENS K0.05.47	 Victoria green RAL 180 30 10									
 Night Red SIKKENS C0.20.20	 Blackblue SIKKENS U0.10.20									
 Jade, pastel RAL 7032	 live simple! No. 8									



## XL 52046

<b>Front decor</b>	snow white (rear in same colour)
<b>Surface</b>	Premium matt lacquer
<b>Front thickness</b>	19 mm
<b>Door shape</b>	15,559 kg/sqm excluding handle weight (see handles) Coffered door, rounded on all sides, radius 3 mm
<b>Front material</b>	MDF substrate with high-quality lacquered surface

### Available glass doors for specific models



Framed glass door...  
e.g. HG 50 78 34 RA

### Reference carcass

**K160F**  
Snow white

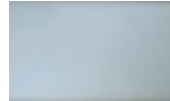
### Visible sides

**MP160**  
Snow White

### Available glass versions



90 clear glass



92 matt glass

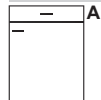


93 black glass



88 Linea glass

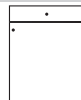
### Available handle arrangements



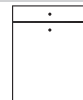
A



B



C



D



M\*

\* = Standard finish

### Grip ledges

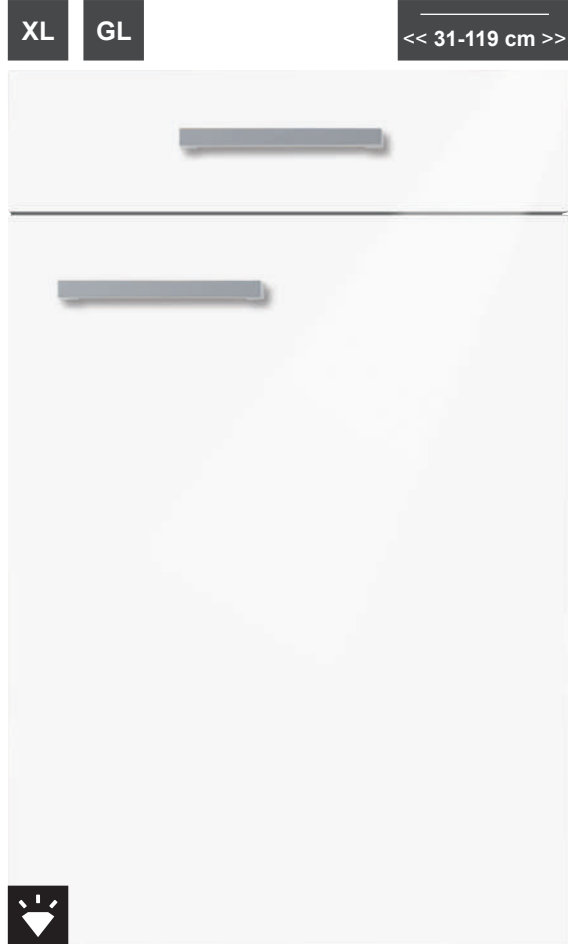
### Handles

### cornices / light pelmets



N 400, N 475,  
N 485,  
N 900 N 975,

<p><b>Front decor</b> premium white</p> <p><b>Surface</b> Premium matt lacquer</p>  <p><b>XL 52050</b></p> <p><b>Reference carcass</b> K039P Premium white</p> <p><b>Visible sides</b> MP039 Premium white</p>	<p><b>Front decor</b> White Agate</p> <p><b>Surface</b> Premium matt lacquer</p>  <p><b>XL 52056</b></p> <p><b>Reference carcass</b> K178F White Agate</p> <p><b>Visible sides</b> MP178 White Agate</p>	<p><b>Front decor</b> Night Green</p> <p><b>Surface</b> Premium matt lacquer</p>  <p><b>XL 52059</b></p> <p><b>Reference carcass</b> K075P Black</p> <p><b>Visible sides</b> MP245 Night Green</p>								
<p><b>Front decor</b> light grey</p> <p><b>Surface</b> Premium matt lacquer</p>  <p><b>XL 52060</b></p> <p><b>Reference carcass</b> K006P Light Grey</p> <p><b>Visible sides</b> MP006 Light Grey</p>	<p><b>Front decor</b> Art Pepper</p> <p><b>Surface</b> Premium matt lacquer</p>  <p><b>XL 52062</b></p> <p><b>Reference carcass</b> K230P Art Pepper</p> <p><b>Visible sides</b> MP230 Art Pepper</p>	<p><b>Front decor</b> Macaron</p> <p><b>Surface</b> Premium matt lacquer</p>  <p><b>XL 52065</b></p> <p><b>Reference carcass</b> K076P Macaron</p> <p><b>Visible sides</b> MP076 Macaron</p>								
<p><b>Front decor</b> Light Nude</p> <p><b>Surface</b> Premium matt lacquer</p>  <p><b>XL 52066</b></p> <p><b>Reference carcass</b> K248P Light Nude</p> <p><b>Visible sides</b> MP248 Light Nude</p>	<p><b>Front decor</b> Fango</p> <p><b>Surface</b> Premium matt lacquer</p>  <p><b>XL 52067</b></p> <p><b>Reference carcass</b> K263P Fango</p> <p><b>Visible sides</b> MP263 Fango</p>	<p><b>Front decor</b> Light Pepper</p> <p><b>Surface</b> Premium matt lacquer</p>  <p><b>XL 52069</b></p> <p><b>Reference carcass</b> K218P Light Pepper</p> <p><b>Visible sides</b> MP218 Light Pepper</p>								
<p><b>Front decor</b> magic grey</p> <p><b>Surface</b> Premium matt lacquer</p>  <p><b>XL 52084</b></p> <p><b>Reference carcass</b> K058P Magic-grey</p> <p><b>Visible sides</b> MP058 Magic-grey</p>	<p><b>Front decor</b> graphite black</p> <p><b>Surface</b> Premium matt lacquer</p>  <p><b>XL 52095</b></p> <p><b>Reference carcass</b> K043P Graphite Black</p> <p><b>Visible sides</b> MP043 Graphite Black</p>	<p><b>Front decor</b> black</p> <p><b>Surface</b> Premium matt lacquer</p>  <p><b>XL 52098</b></p> <p><b>Reference carcass</b> K075P Black</p> <p><b>Visible sides</b> MP075 Black</p>								
<p><b>Front decor</b> special colour</p> <p><b>Surface</b> Premium matt lacquer</p>  <p><b>XL 52099</b></p> <p><b>Reference carcass</b> K023P Stainless Steel Colour</p> <p><b>Visible sides</b> MP099 special colour</p>	<p style="text-align: center;"><b>Colour concept at no extra charge</b></p> <table border="1"> <tbody> <tr> <td data-bbox="595 1751 826 1839">  Sealbrown RAL 8019                 </td> <td data-bbox="826 1751 1062 1839">  Cristal red SIKKENS C0.60.30                 </td> </tr> <tr> <td data-bbox="595 1839 826 1926">  Savona green SIKKENS K0.05.47                 </td> <td data-bbox="826 1839 1062 1926">  Victoria green RAL 180 30 10                 </td> </tr> <tr> <td data-bbox="595 1926 826 2013">  Night Red SIKKENS C0.20.20                 </td> <td data-bbox="826 1926 1062 2013">  Blackblue SIKKENS U0.10.20                 </td> </tr> <tr> <td data-bbox="595 2013 826 2096">  Jade, pastel RAL 7032                 </td> <td data-bbox="826 2013 1062 2096">  live simple! No. 8                 </td> </tr> </tbody> </table>		 Sealbrown RAL 8019	 Cristal red SIKKENS C0.60.30	 Savona green SIKKENS K0.05.47	 Victoria green RAL 180 30 10	 Night Red SIKKENS C0.20.20	 Blackblue SIKKENS U0.10.20	 Jade, pastel RAL 7032	 live simple! No. 8
 Sealbrown RAL 8019	 Cristal red SIKKENS C0.60.30									
 Savona green SIKKENS K0.05.47	 Victoria green RAL 180 30 10									
 Night Red SIKKENS C0.20.20	 Blackblue SIKKENS U0.10.20									
 Jade, pastel RAL 7032	 live simple! No. 8									



**XL 5646**

- Front decor** snow white  
(rear in same colour)
- Surface** High-gloss lacquer
- Front thickness** 19 mm
- Door shape** 15,559 kg/sqm excluding handle weight (see handles)  
Coffer door, rounded on all sides, radius 3 mm
- Front material** MDF substrate with high-quality lacquered surface

**Available glass doors for specific models**



**Framed glass door...**  
e.g. HG 50 78 34 RA

**Reference carcass**

**K160G**  
Snow White Gloss

**Visible sides**

**H160H**  
Snow White

**Available glass versions**



90 clear glass



92 matt glass

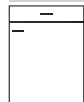


93 black glass

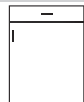


88 Linea glass

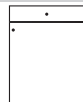
**Available handle arrangements**



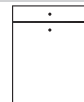
**A\***



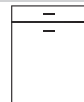
**B**



**C**



**D**



**M**

\* = Standard finish


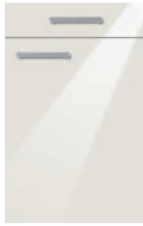



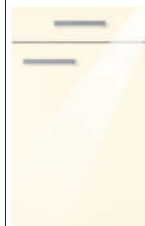

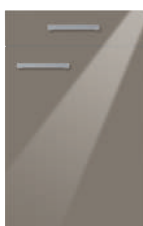
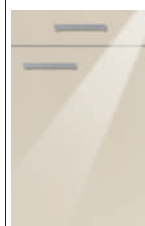

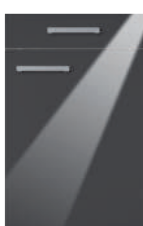


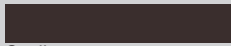






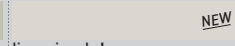
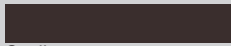






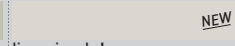
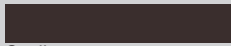






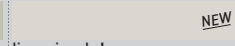
**Grip ledges**

**Handles**

**cornices / light pelmets**



N 400, N 475,  
N 485,  
N 900 N 975,

<p><b>Front decor</b> premium white</p> <p><b>Surface</b> High-gloss lacquer</p>  <p><b>XL 5650</b></p> <p><b>Reference carcass</b> K039G Premium white glossy</p> <p><b>Visible sides</b> H039H Premium white</p>	<p><b>Front decor</b> White Agate</p> <p><b>Surface</b> High-gloss lacquer</p>  <p><b>XL 5656</b></p> <p><b>Reference carcass</b> K178F White Agate</p> <p><b>Visible sides</b> H178H White Agate</p>	<p><b>Front decor</b> Night Green</p> <p><b>Surface</b> High-gloss lacquer</p>  <p><b>XL 5659</b></p> <p><b>Reference carcass</b> K075P Black</p> <p><b>Visible sides</b> H245H Night Green</p>								
<p><b>Front decor</b> light grey</p> <p><b>Surface</b> High-gloss lacquer</p>  <p><b>XL 5660</b></p> <p><b>Reference carcass</b> K006P Light Grey</p> <p><b>Visible sides</b> H006H Light Grey</p>	<p><b>Front decor</b> Art Pepper</p> <p><b>Surface</b> High-gloss lacquer</p>  <p><b>XL 5661</b></p> <p><b>Reference carcass</b> K230P Art Pepper</p> <p><b>Visible sides</b> H230H Art Pepper</p>	<p><b>Front decor</b> Macaron</p> <p><b>Surface</b> High-gloss lacquer</p>  <p><b>XL 5665</b></p> <p><b>Reference carcass</b> K076P Macaron</p> <p><b>Visible sides</b> H076H Macaron</p>								
<p><b>Front decor</b> Light Nude</p> <p><b>Surface</b> High-gloss lacquer</p>  <p><b>XL 5666</b></p> <p><b>Reference carcass</b> K248P Light Nude</p> <p><b>Visible sides</b> H248H Light Nude</p>	<p><b>Front decor</b> Fango</p> <p><b>Surface</b> High-gloss lacquer</p>  <p><b>XL 5667</b></p> <p><b>Reference carcass</b> K263P Fango</p> <p><b>Visible sides</b> H263H Fango</p>	<p><b>Front decor</b> Light Pepper</p> <p><b>Surface</b> High-gloss lacquer</p>  <p><b>XL 5669</b></p> <p><b>Reference carcass</b> K218P Light Pepper</p> <p><b>Visible sides</b> H218H Light Pepper</p>								
<p><b>Front decor</b> magic grey</p> <p><b>Surface</b> High-gloss lacquer</p>  <p><b>XL 5684</b></p> <p><b>Reference carcass</b> K058P Magic-grey</p> <p><b>Visible sides</b> H058H Magic-grey</p>	<p><b>Front decor</b> graphite black</p> <p><b>Surface</b> High-gloss lacquer</p>  <p><b>XL 5695</b></p> <p><b>Reference carcass</b> K043P Graphite Black</p> <p><b>Visible sides</b> H043H Graphite Black</p>	<p><b>Front decor</b> black</p> <p><b>Surface</b> High-gloss lacquer</p>  <p><b>XL 5698</b></p> <p><b>Reference carcass</b> K075P Black</p> <p><b>Visible sides</b> H075H Black</p>								
<p><b>Front decor</b> special colour</p> <p><b>Surface</b> High-gloss lacquer</p>  <p><b>XL 5699</b></p> <p><b>Reference carcass</b> K023P Stainless Steel Colour</p> <p><b>Visible sides</b> H099H special colour</p>	<p style="text-align: center;"><b>Colour concept at no extra charge</b></p> <table border="1"> <tbody> <tr> <td data-bbox="595 1751 826 1841">  Sealbrown RAL 8019                 </td> <td data-bbox="826 1751 1062 1841">  Cristal red SIKKENS C0.60.30                 </td> </tr> <tr> <td data-bbox="595 1841 826 1930">  Savona green SIKKENS K0.05.47                 </td> <td data-bbox="826 1841 1062 1930">  Victoria green RAL 180 30 10                 </td> </tr> <tr> <td data-bbox="595 1930 826 2020">  Night Red SIKKENS C0.20.20                 </td> <td data-bbox="826 1930 1062 2020">  Blackblue SIKKENS U0.10.20                 </td> </tr> <tr> <td data-bbox="595 2020 826 2096">  Jade, pastel RAL 7032                 </td> <td data-bbox="826 2020 1062 2096">  live simple! No. 8                 </td> </tr> </tbody> </table>		 Sealbrown RAL 8019	 Cristal red SIKKENS C0.60.30	 Savona green SIKKENS K0.05.47	 Victoria green RAL 180 30 10	 Night Red SIKKENS C0.20.20	 Blackblue SIKKENS U0.10.20	 Jade, pastel RAL 7032	 live simple! No. 8
 Sealbrown RAL 8019	 Cristal red SIKKENS C0.60.30									
 Savona green SIKKENS K0.05.47	 Victoria green RAL 180 30 10									
 Night Red SIKKENS C0.20.20	 Blackblue SIKKENS U0.10.20									
 Jade, pastel RAL 7032	 live simple! No. 8									



**XL 5995**

**Front decor** graphite black oak lacquered (rear in same colour)  
**Surface** Veneer sealed with high-quality lacquer  
**Front thickness** 19 mm  
 14,054 kg/sqm excluding handle weight (see handles)  
**Door shape** straight, 4 sides with thick oak veneer edge 1.5 mm  
**Front material** Multi-layer particle board, oak veneer on both sides

**Available glass doors for specific models**



**Semi-frameless glass door...**  
e.g. HG 50 78 34 LS

**Semi-frameless glass door / glass width 5 cm...**  
e.g. HG 50 78 34 LB

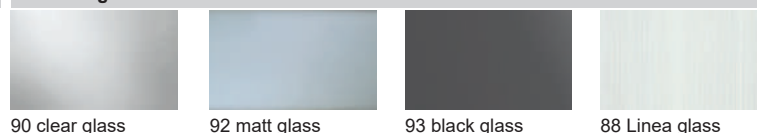
**Reference carcase**

**K043P**  
Graphite Black

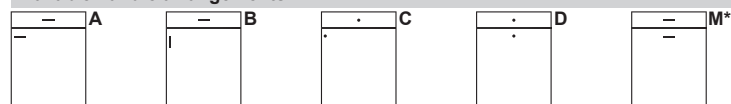
**Visible sides**

**F043S**  
Graphite Black  
Lacquered

**Available glass versions**



**Available handle arrangements**



\* = Standard finish

**Grip ledges**

N 400, N 475,  
N 485,  
N 900 N 975,

**Handles**

~~M330 M340~~

**cornices / light pelmets**

**Front decor** Special colour oak veneer  
**Surface** sealed with high-quality lacquer

**XL 5949**

**Reference carcase**  
**K230P**  
Art Pepper


**Visible sides**  
**F099K**  
special colour lacquered

**Colour concept at no extra charge**

Sealbrown RAL 8019	Cristal red SIKKENS C0.60.30
Savona green SIKKENS K0.05.47	Victoria green RAL 180 30 10
Night Red SIKKENS C0.20.20	Blackblue SIKKENS U0.10.20
Jade, pastel RAL 7032 <b>NEW</b>	live simple! No. 8 <b>NEW</b>



**Front decor** Premium white lacquered oak  
**Surface** Veneer sealed with high-quality lacquer




**XL 5920**

**Reference carcass**  
**K039P**  
 Premium white

**Visible sides**  
**F039S**  
 premium white lacquer

**Front decor** Moderno Rustico oak stained  
**Surface** Veneer sealed with high-quality lacquer

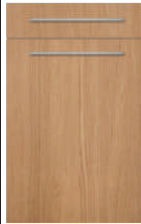


**XL 5921**

**Reference carcass**  
**K230P**  
 Art Pepper

**Visible sides**  
**F279K**  
 Moderno Rustico oak stained

**Front decor** Urban Oak Stained  
**Surface** Veneer sealed with high-quality lacquer




**XL 5924**

**Reference carcass**  
**K230P**  
 Art Pepper

**Visible sides**  
**F261K**  
 Urban Oak stained

**Front decor** black lacquered oak  
**Surface** Veneer sealed with high-quality lacquer




**XL 5925**

**Reference carcass**  
**K075P**  
 Black

**Visible sides**  
**F075S**  
 black lacquer

**Front decor** Eiche Light Nude lacquered  
**Surface** Veneer sealed with high-quality lacquer

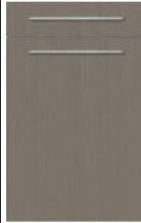


**XL 5926**

**Reference carcass**  
**K248P**  
 Light Nude

**Visible sides**  
**F248S**  
 Light Nude lacquered

**Front decor** Fango oak, lacquered  
**Surface** Veneer sealed with high-quality lacquer




**XL 5927**

**Reference carcass**  
**K263P**  
 Fango

**Visible sides**  
**F263S**  
 Fango

**Front decor** Oak Night Green lacquered  
**Surface** Veneer sealed with high-quality lacquer




**XL 5929**

**Reference carcass**  
**K075P**  
 Black

**Visible sides**  
**F245S**  
 Night Green lacquered

**Front decor** oak Art Pepper lacquered  
**Surface** Veneer sealed with high-quality lacquer




**XL 5940**

**Reference carcass**  
**K230P**  
 Art Pepper

**Visible sides**  
**F230S**  
 Art Pepper lacquered

**Front decor** Macaron oak lacquered  
**Surface** Veneer sealed with high-quality lacquer




**XL 5965**

**Reference carcass**  
**K076P**  
 Macaron

**Visible sides**  
**F076K**  
 Macaron lacquered

**Front decor** oak Light Pepper lacquered  
**Surface** Veneer sealed with high-quality lacquer




**XL 5969**

**Reference carcass**  
**K218P**  
 Light Pepper

**Visible sides**  
**F218S**  
 Light Pepper lacquered

**Front decor** oak stained silky grey  
**Surface** Veneer sealed with high-quality lacquer




**XL 5970**

**Reference carcass**  
**K230P**  
 Art Pepper

**Visible sides**  
**F058K**  
 Silky grey, stained

**Front decor** untreated oak, stained  
**Surface** Veneer sealed with high-quality lacquer




**XL 5975**

**Reference carcass**  
**K230P**  
 Art Pepper

**Visible sides**  
**F213K**  
 untreated stained

**Front decor** coffee brown oak stained  
**Surface** Veneer sealed with high-quality lacquer




**XL 5980**

**Reference carcass**  
**K075P**  
 Black

**Visible sides**  
**F214K**  
 coffee brown stained

**Front decor** Gavi oak veneer  
**Surface** Veneer sealed with high-quality lacquer

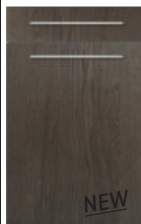


**XL 5996**

**Reference carcass**  
**K230P**  
 Art Pepper

**Visible sides**  
**F258K**  
 Gavi oak veneer

**Front decor** Dark oak stained  
**Surface** Veneer sealed with high-quality lacquer



**XL 5998**

**Reference carcass**  
**K075P**  
 Black

**Visible sides**  
**F259K**  
 Dark oak stained



**XL 5420**

- Front decor** graphite black oak lacquered (rear in same colour)
- Surface** Veneer sealed with high-quality lacquer
- Front thickness** 19 mm
- Door shape** 12,757 kg/sqm excluding handle weight (see handles) straight, 4 sides with thick oak veneer edge 1.5 mm
- Front material** Multi-layer particle board, oak veneer on both sides

**Available glass doors for specific models**

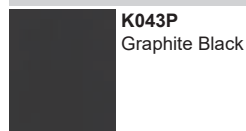


**Semi-frameless glass door...**  
e.g. HG 50 78 34 LS



**Semi-frameless glass door / glass width 5 cm...**  
e.g. HG 50 78 34 LB

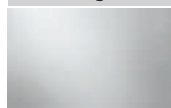
**Reference carcass**



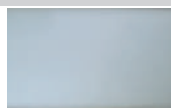
**Visible sides**



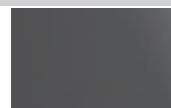
**Available glass versions**



90 clear glass



92 matt glass



93 black glass



88 Linea glass

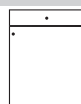
**Available handle arrangements**



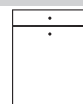
A



B



C



D



M\*

\* = Standard finish

**Grip ledges**



N 400, N 475,  
N 485,  
N 900 N 975,

**Handles**



M330 M340

**cornices / light pelmets**

- Front decor** Special colour oak veneer
- Surface** Veneer sealed with high-quality lacquer



**XL 5439**


**Reference carcass**  
K230P  
Art Pepper

- Visible sides**
- F099K special colour lacquered

**Colour concept at no extra charge**

Sealbrown RAL 8019	Cristal red SIKKENS C0.60.30
Savona green SIKKENS K0.05.47	Victoria green RAL 180 30 10
Night Red SIKKENS C0.20.20	Blackblue SIKKENS U0.10.20
Jade, pastel RAL 7032 <b>NEW</b>	live simple! No. 8 <b>NEW</b>

**Front decor** Premium white lacquered oak  
**Surface** Veneer sealed with high-quality lacquer




**XL 5400**

**Reference carcass**  
**K039P**  
 Premium white

**Visible sides**  
**F039S**  
 premium white lacquer

**Front decor** black lacquered oak  
**Surface** Veneer sealed with high-quality lacquer




**XL 5402**

**Reference carcass**  
**K075P**  
 Black

**Visible sides**  
**F075S**  
 black lacquer

**Front decor** Macaron oak lacquered  
**Surface** Veneer sealed with high-quality lacquer




**XL 5410**

**Reference carcass**  
**K076P**  
 Macaron

**Visible sides**  
**F076K**  
 Macaron lacquered

**Front decor** Moderno Rustico oak stained  
**Surface** Veneer sealed with high-quality lacquer




**XL 5411**

**Reference carcass**  
**K230P**  
 Art Pepper

**Visible sides**  
**F279K**  
 Moderno Rustico oak stained

**Front decor** oak Light Pepper lacquered  
**Surface** Veneer sealed with high-quality lacquer




**XL 5412**

**Reference carcass**  
**K218P**  
 Light Pepper

**Visible sides**  
**F218S**  
 Light Pepper lacquered

**Front decor** oak stained silky grey  
**Surface** Veneer sealed with high-quality lacquer



**XL 5414**

**Reference carcass**  
**K230P**  
 Art Pepper

**Visible sides**  
**F058K**  
 Silly grey, stained

**Front decor** untreated oak, stained  
**Surface** Veneer sealed with high-quality lacquer




**XL 5416**

**Reference carcass**  
**K230P**  
 Art Pepper

**Visible sides**  
**F213K**  
 untreated stained

**Front decor** coffee brown oak stained  
**Surface** Veneer sealed with high-quality lacquer

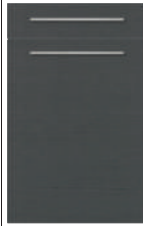


**XL 5418**

**Reference carcass**  
**K075P**  
 Black

**Visible sides**  
**F214K**  
 coffee brown stained

**Front decor** oak Art Pepper lacquered  
**Surface** Veneer sealed with high-quality lacquer




**XL 5422**

**Reference carcass**  
**K230P**  
 Art Pepper

**Visible sides**  
**F230S**  
 Art Pepper lacquered

**Front decor** Urban Oak Stained  
**Surface** Veneer sealed with high-quality lacquer




**XL 5424**

**Reference carcass**  
**K230P**  
 Art Pepper

**Visible sides**  
**F261K**  
 Urban Oak stained

**Front decor** Eiche Light Nude lacquered  
**Surface** Veneer sealed with high-quality lacquer

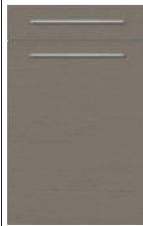


**XL 5426**

**Reference carcass**  
**K248P**  
 Light Nude

**Visible sides**  
**F248S**  
 Light Nude lacquered

**Front decor** Fango oak, lacquered  
**Surface** Veneer sealed with high-quality lacquer




**XL 5427**

**Reference carcass**  
**K263P**  
 Fango

**Visible sides**  
**F263S**  
 Fango

**Front decor** Oak Night Green lacquered  
**Surface** Veneer sealed with high-quality lacquer




**XL 5429**

**Reference carcass**  
**K075P**  
 Black

**Visible sides**  
**F245S**  
 Night Green lacquered

**Front decor** Gavi oak veneer  
**Surface** Veneer sealed with high-quality lacquer

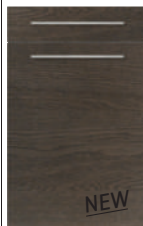


**XL 5430**

**Reference carcass**  
**K230P**  
 Art Pepper

**Visible sides**  
**F258K**  
 Gavi oak veneer

**Front decor** Dark oak stained  
**Surface** Veneer sealed with high-quality lacquer

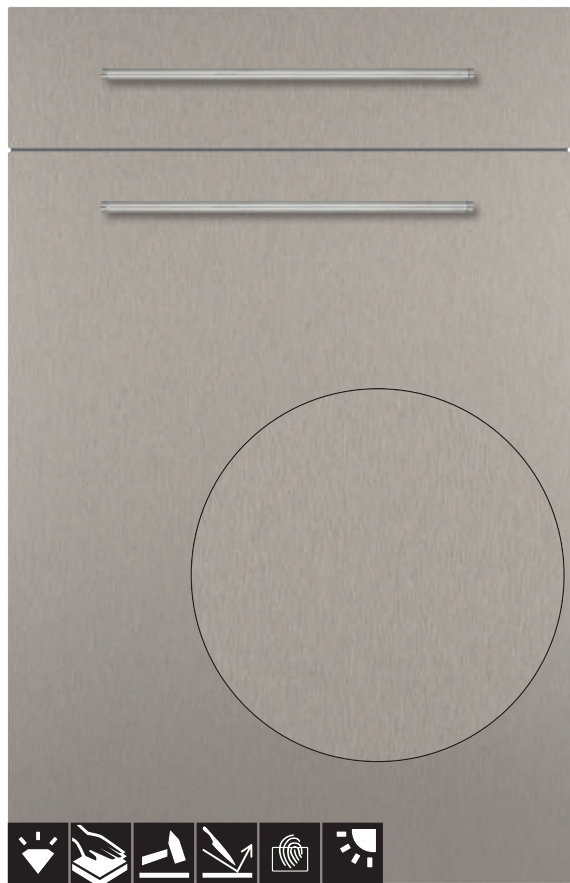


**XL 5432**

**Reference carcass**  
**K075P**  
 Black

**Visible sides**  
**F259K**  
 Dark oak stained

**XL** **GL** **FENIX** << 31-119 cm >>



**XL 5011**

**Front decor** metal facing stainless steel look super matt (rear in same colour)  
**Surface** Original FENIX smooth (super matt)  
**Front thickness** 19 mm  
**Door shape** straight, 4 sides with contoured PP edge 1.3 mm, PUR edge gluing  
**Front material** multi-layer particle board both sides with laminate with metal coating

**Available glass doors for specific models**



**Reference carcass**  
**K075P**  
 Black

**Visible sides**  
**C023M**  
 stainless steel look super matt

**Available glass versions**

90 clear glass    92 matt glass    93 black glass    88 Linea glass

**Available handle arrangements**

**\* = Standard finish**

**Grip ledges**    **Handles**    **cornices / light pelmets**

N 400, N 475,  
 N 485,  
 N 900 N 975,  
 N 700, N 775



**XL 6575**

- Front decor** black (rear in same colour)
- Surface** smooth (matt)
- Front thickness** 20 mm
- Door shape** All round with radius on the front edge, multiplex substrate oiled on the edge
- Front material** Multiplex, both sides with 0.8 mm laminate

**NEW**

**Reference carcass**

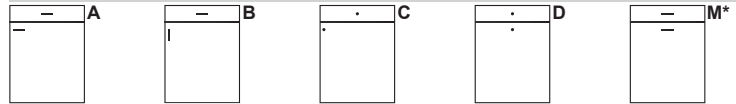


**K075P**  
Black

**Visible sides**

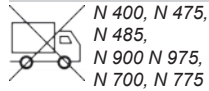


**Available handle arrangements**



\* = Standard finish

**Grip ledges**



**Handles**



**cornices / light pelmets**

**Front decor** premium white

**Surface** smooth (matt)



**XL 6580**

**Reference carcass**

**K039P**  
Premium white

**NEW**

**Visible sides**

**Front decor** Dark Powder

**Surface** smooth (matt)



**XL 6585**

**Reference carcass**

**K075P**  
Black

**NEW**

**Visible sides**

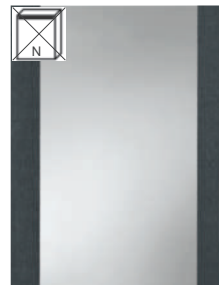


**XL 6095**

**Front decor** graphite black oak lacquered (rear in same colour)  
**Surface** Veneer sealed with high-quality lacquer  
**Front thickness** 19 mm  
 14,054 kg/sqm excluding handle weight (see handles)  
**Door shape** straight, 4 sides with thick oak veneer edge 1.5 mm, vertical grooving 150 mm  
**Front material** Multi-layer particle board, oak veneer on both sides

**Note:**  
 Width 20 cm is supplied with smooth fronts  
 Please avoid combining different front widths on the same single cabinet type!

**Available glass doors for specific models**



**Semi-frameless glass door...**  
 e.g. HG 50 78 34 LS

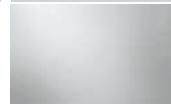
**Reference carcass**

**K043P**  
 Graphite Black

**Visible sides**

**F043S**  
 Graphite Black  
 Lacquered

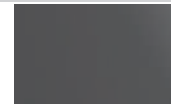
**Available glass versions**



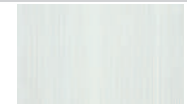
90 clear glass



92 matt glass



93 black glass



88 Linea glass

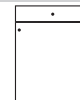
**Available handle arrangements**



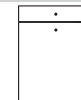
A



B



C\*



D



M

\* = Standard finish

**Grip ledges**



N 400, N 475,  
 N 485,  
 N 700, N 775  
 N 900 N 975,

**Handles**



M330 M340

**cornices / light pelmets**

**Front decor** Special colour oak veneer  
**Surface** Veneer sealed with high-quality lacquer

**XL 6049**



**Reference carcass**  
**K230P**  
 Art Pepper

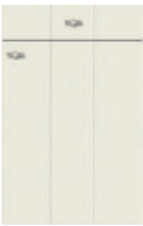
**Visible sides**  
**F099K**  
 special colour lacquered

**Colour concept at no extra charge**

Sealbrown RAL 8019	Cristal red SIKKENS C0.60.30
Savona green SIKKENS K0.05.47	Victoria green RAL 180 30 10
Night Red SIKKENS C0.20.20	Blackblue SIKKENS U0.10.20
Jade, pastel RAL 7032 <b>NEW</b>	live simple! No. 8 <b>NEW</b>



**Front decor** Premium white lacquered oak  
**Surface** Veneer sealed with high-quality lacquer

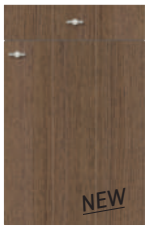


**XL 6020**

**Reference carcass**  
**K039P**  
 Premium white

**Visible sides**  
**F039S**  
 premium white lacquer

**Front decor** Moderno Rustico oak stained  
**Surface** Veneer sealed with high-quality lacquer




**XL 6021**

**Reference carcass**  
**K230P**  
 Art Pepper

**Visible sides**  
**F279K**  
 Moderno Rustico oak stained

**Front decor** Urban Oak Stained  
**Surface** Veneer sealed with high-quality lacquer




**XL 6024**

**Reference carcass**  
**K230P**  
 Art Pepper

**Visible sides**  
**F261K**  
 Urban Oak stained

**Front decor** Eiche Light Nude lacquered  
**Surface** Veneer sealed with high-quality lacquer



**XL 6026**

**Reference carcass**  
**K248P**  
 Light Nude

**Visible sides**  
**F248S**  
 Light Nude lacquered

**Front decor** black lacquered oak  
**Surface** Veneer sealed with high-quality lacquer

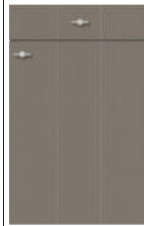


**XL 6025**

**Reference carcass**  
**K075P**  
 Black

**Visible sides**  
**F075S**  
 black lacquer

**Front decor** Fango oak, lacquered  
**Surface** Veneer sealed with high-quality lacquer



**XL 6027**

**Reference carcass**  
**K263P**  
 Fango

**Visible sides**  
**F263S**  
 Fango, lacquered

**Front decor** Gavi oak veneer  
**Surface** Veneer sealed with high-quality lacquer




**XL 6028**

**Reference carcass**  
**K230P**  
 Art Pepper

**Visible sides**  
**F258K**  
 Gavi oak veneer

**Front decor** Oak Night Green lacquered  
**Surface** Veneer sealed with high-quality lacquer

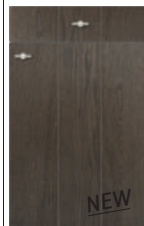


**XL 6029**

**Reference carcass**  
**K075P**  
 Black

**Visible sides**  
**F245S**  
 Night Green lacquered

**Front decor** Dark oak stained  
**Surface** Veneer sealed with high-quality lacquer




**XL 6031**

**Reference carcass**  
**K075P**  
 Black

**Visible sides**  
**F259K**  
 Dark oak stained

**Front decor** oak Art Pepper lacquered  
**Surface** Veneer sealed with high-quality lacquer




**XL 6040**

**Reference carcass**  
**K230P**  
 Art Pepper

**Visible sides**  
**F230S**  
 Art Pepper lacquered

**Front decor** Macaron oak lacquered  
**Surface** Veneer sealed with high-quality lacquer

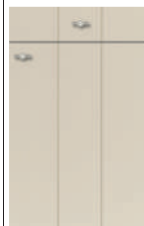


**XL 6065**

**Reference carcass**  
**K076P**  
 Macaron

**Visible sides**  
**F076K**  
 Macaron lacquered

**Front decor** oak Light Pepper lacquered  
**Surface** Veneer sealed with high-quality lacquer



**XL 6069**

**Reference carcass**  
**K218P**  
 Light Pepper

**Visible sides**  
**F218S**  
 Light Pepper lacquered

**Front decor** oak stained silky grey  
**Surface** Veneer sealed with high-quality lacquer




**XL 6070**

**Reference carcass**  
**K230P**  
 Art Pepper

**Visible sides**  
**F058K**  
 Silky grey, stained

**Front decor** untreated oak, stained  
**Surface** Veneer sealed with high-quality lacquer



**XL 6075**

**Reference carcass**  
**K230P**  
 Art Pepper

**Visible sides**  
**F213K**  
 untreated stained

**Front decor** coffee brown oak stained  
**Surface** Veneer sealed with high-quality lacquer



**XL 6080**

**Reference carcass**  
**K075P**  
 Black

**Visible sides**  
**F214K**  
 coffee brown stained





**Reference carcase**  
**K230P**  
 Art Pepper

**Visible sides**  
**Z261K**  
 Urban Oak stained

**XL 6751**

- Front decor** Bavaria oak Urban Oak stained (rear in same colour)
- Surface** Veneer sealed with high-quality lacquer
- Front thickness** 20 mm
- Door shape** 9,730 kg/sqm excluding handle weight (see handles)  
Coffer front, frame width 90 mm
- Front material** Multi-layer particle board, oak veneer on both sides, rear smooth

**Note:**  
 Width 15 cm is supplied with smooth fronts  
 Width 20 cm is supplied with smooth fronts  
 Range always without tightening fitting!

**Quality description:**  
 The veneer pattern includes small knot flecks in various forms.

**Available glass doors for specific models**



Framed glass door...  
 e.g. HG 50 78 34 RA

**Available glass versions**

90 clear glass	92 matt glass	93 black glass	88 Linea glass

**Available handle arrangements**

A	B	C	D	M*

\* = Standard finish

<b>Grip ledges</b>	<b>Handles</b>	<b>cornices / light pelmets</b>
N 400, N 475, N 485, N 700, N 775, N 900 N 975	M330 M340	

**Front decor** Bavaria oak veneer special colours

**Surface** Veneer sealed with high-quality lacquer


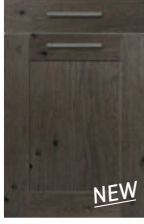

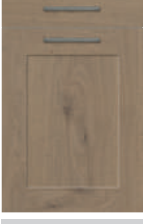

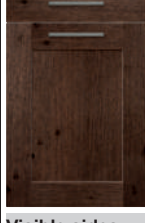


**XL 6764**

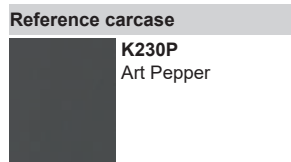
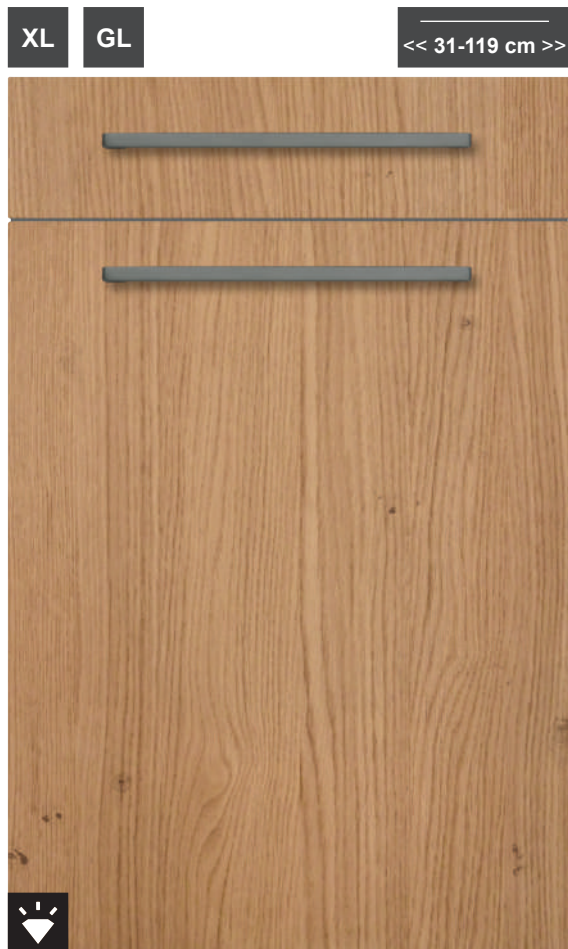
**Reference carcase**  
**K230P**  
 Art Pepper

**Visible sides**  
**Z099K**  
 special colour lacquered

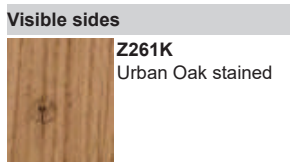
**Colour concept at no extra charge**

 Sealbrown RAL 8019	 Cristal red SIKKENS C0.60.30
 Savona green SIKKENS K0.05.47	 Victoria green RAL 180 30 10
 Night Red SIKKENS C0.20.20	 Blackblue SIKKENS U0.10.20
 Jade, pastel RAL 7032 <b>NEW</b>	 live simple! No. 8 <b>NEW</b>

<p><b>Front decor</b> Premium white lacquered Bavaria oak</p> <p><b>Surface</b> Veneer sealed with high-quality lacquer</p>  <p><b>XL 6742</b></p> <p><b>Reference carcass</b> K039P Premium white</p> <p><b>Visible sides</b> Z039S premium white lacquer</p>	<p><b>Front decor</b> Bavaria oak stained Moderno Rustico</p> <p><b>Surface</b> Veneer sealed with high-quality lacquer</p>  <p><b>XL 6741</b></p> <p><b>Reference carcass</b> K230P Art Pepper</p> <p><b>Visible sides</b> Z279K Moderno Rustico, stained</p>	<p><b>Front decor</b> black lacquered Bavaria oak</p> <p><b>Surface</b> Veneer sealed with high-quality lacquer</p>  <p><b>XL 6744</b></p> <p><b>Reference carcass</b> K075P Black</p> <p><b>Visible sides</b> Z075S black lacquer</p>
<p><b>Front decor</b> Gavi Bavaria oak, stained</p> <p><b>Surface</b> Veneer sealed with high-quality lacquer</p>  <p><b>XL 6745</b></p> <p><b>Reference carcass</b> K230P Art Pepper</p> <p><b>Visible sides</b> Z258K Gavi oak veneer</p>	<p><b>Front decor</b> dark Bavaria oak, stained</p> <p><b>Surface</b> Veneer sealed with high-quality lacquer</p>  <p><b>XL 6747</b></p> <p><b>Reference carcass</b> K075P Black</p> <p><b>Visible sides</b> Z259K Dark oak stained</p>	<p><b>Front decor</b> Bavaria oak Night Green lacquered</p> <p><b>Surface</b> Veneer sealed with high-quality lacquer</p>  <p><b>XL 6749</b></p> <p><b>Reference carcass</b> K075P Black</p> <p><b>Visible sides</b> Z245S Night Green lacquered</p>
<p><b>Front decor</b> silky grey Bavaria oak stained</p> <p><b>Surface</b> Veneer sealed with high-quality lacquer</p>  <p><b>XL 6750</b></p> <p><b>Reference carcass</b> K230P Art Pepper</p> <p><b>Visible sides</b> Z058K Sily grey, stained</p>	<p><b>Front decor</b> graphite black Bavaria oak lacquered</p> <p><b>Surface</b> Veneer sealed with high-quality lacquer</p>  <p><b>XL 6752</b></p> <p><b>Reference carcass</b> K043P Graphite Black</p> <p><b>Visible sides</b> Z043S Graphite Black Lacquered</p>	<p><b>Front decor</b> Macaron Bavaria oak lacquered</p> <p><b>Surface</b> Veneer sealed with high-quality lacquer</p>  <p><b>XL 6754</b></p> <p><b>Reference carcass</b> K076P Macaron</p> <p><b>Visible sides</b> Z076K Macaron lacquered</p>
<p><b>Front decor</b> untreated Bavaria oak stained</p> <p><b>Surface</b> Veneer sealed with high-quality lacquer</p>  <p><b>XL 6758</b></p> <p><b>Reference carcass</b> K230P Art Pepper</p> <p><b>Visible sides</b> Z213K untreated stained</p>	<p><b>Front decor</b> Bavaria oak Light Pepper lacquered</p> <p><b>Surface</b> Veneer sealed with high-quality lacquer</p>  <p><b>XL 6759</b></p> <p><b>Reference carcass</b> K218P Light Pepper</p> <p><b>Visible sides</b> Z218S Light Pepper lacquered</p>	<p><b>Front decor</b> coffee brown Bavaria oak stained</p> <p><b>Surface</b> Veneer sealed with high-quality lacquer</p>  <p><b>XL 6760</b></p> <p><b>Reference carcass</b> K075P Black</p> <p><b>Visible sides</b> Z214K coffee brown stained</p>
<p><b>Front decor</b> Bavaria oak Art Pepper lacquered</p> <p><b>Surface</b> Veneer sealed with high-quality lacquer</p>  <p><b>XL 6762</b></p> <p><b>Reference carcass</b> K230P Art Pepper</p> <p><b>Visible sides</b> Z230S Art Pepper lacquered</p>	<p><b>Front decor</b> Light Nude Bavaria oak, lacquered</p> <p><b>Surface</b> Veneer sealed with high-quality lacquer</p>  <p><b>XL 6763</b></p> <p><b>Reference carcass</b> K248P Light Nude</p> <p><b>Visible sides</b> Z248S Light Nude lacquered</p>	<p><b>Front decor</b> Fango Bavaria oak, lacquered</p> <p><b>Surface</b> Veneer sealed with high-quality lacquer</p>  <p><b>XL 6767</b></p> <p><b>Reference carcass</b> K263P Fango</p> <p><b>Visible sides</b> Z263S Fango, lacquered</p>



**Reference carcase**  
K230P  
Art Pepper



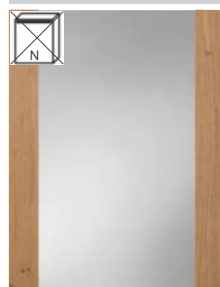
**Visible sides**  
Z261K  
Urban Oak stained

**XL 6854**

**Front decor** Bavaria oak Urban Oak stained (rear in same colour)  
**Surface** Veneer sealed with high-quality lacquer  
**Front thickness** 20 mm  
 14,054 kg/sqm excluding handle weight (see handles)  
**Door shape** straight, 4 sides with thick oak veneer edge 1.5 mm  
**Front material** Multi-layer particle board, oak veneer on both sides, rear smooth

**Quality description:**  
The veneer pattern includes small knot flecks in various forms.

**Available glass doors for specific models**

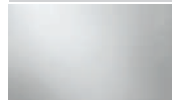


**Semi-frameless glass door...**  
e.g. HG 50 78 34 LS



**Semi-frameless glass door / glass width 5 cm...**  
e.g. HG 50 78 34 LB

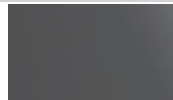
**Available glass versions**



90 clear glass



92 matt glass

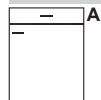


93 black glass



88 Linea glass

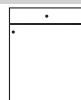
**Available handle arrangements**



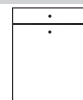
A



B



C



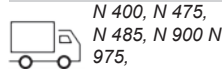
D



M\*

\* = Standard finish

**Grip ledges**      **Handles**      **cornices / light pelmets**



N 400, N 475,  
N 485, N 900 N  
975,



M330 M340

**Front decor** Bavaria oak veneer special colours  
**Surface** Veneer sealed with high-quality lacquer



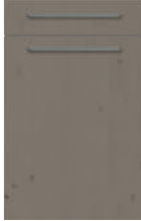


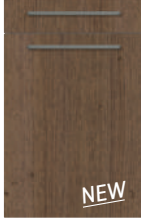

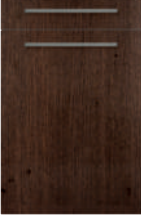


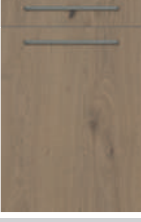


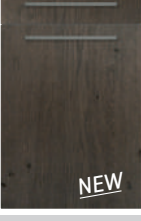

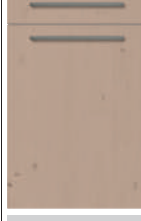
**XL 6849**

**Reference carcase**  
K230P  
Art Pepper

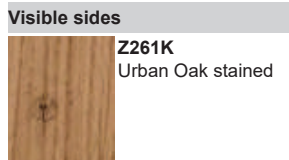
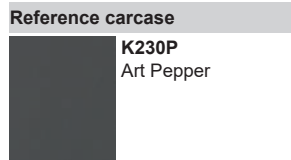
**Visible sides**  
Z099K  
special colour lacquered

**Colour concept at no extra charge**

Sealbrown RAL 8019	Cristal red SIKKENS C0.60.30
Savona green SIKKENS K0.05.47	Victoria green RAL 180 30 10
Night Red SIKKENS C0.20.20	Blackblue SIKKENS U0.10.20
Jade, pastel RAL 7032 <b>NEW</b>	live simple! No. 8 <b>NEW</b>

<p><b>Front decor</b> Premium white lacquered Bavaria oak</p> <p><b>Surface</b> Veneer sealed with high-quality lacquer</p>  <p><b>XL 6826</b></p> <p><b>Reference carcass</b> K039P Premium white</p> <p><b>Visible sides</b> Z039S premium white lacquer</p>	<p><b>Front decor</b> Fango Bavaria oak, lacquered</p> <p><b>Surface</b> Veneer sealed with high-quality lacquer</p>  <p><b>XL 6827</b></p> <p><b>Reference carcass</b> K263P Fango</p> <p><b>Visible sides</b> Z263S Fango, lacquered</p>	<p><b>Front decor</b> black lacquered Bavaria oak</p> <p><b>Surface</b> Veneer sealed with high-quality lacquer</p>  <p><b>XL 6828</b></p> <p><b>Reference carcass</b> K075P Black</p> <p><b>Visible sides</b> Z075S black lacquer</p>
<p><b>Front decor</b> Bavaria oak Night Green lacquered</p> <p><b>Surface</b> Veneer sealed with high-quality lacquer</p>  <p><b>XL 6829</b></p> <p><b>Reference carcass</b> K075P Black</p> <p><b>Visible sides</b> Z245S Night Green lacquered</p>	<p><b>Front decor</b> Bavaria oak stained Moderno Rustico</p> <p><b>Surface</b> Veneer sealed with high-quality lacquer</p>  <p><b>XL 6831</b></p> <p><b>Reference carcass</b> K230P Art Pepper</p> <p><b>Visible sides</b> Z279K Moderno Rustico, stained</p>	<p><b>Front decor</b> untreated Bavaria oak stained</p> <p><b>Surface</b> Veneer sealed with high-quality lacquer</p>  <p><b>XL 6832</b></p> <p><b>Reference carcass</b> K230P Art Pepper</p> <p><b>Visible sides</b> Z213K untreated stained</p>
<p><b>Front decor</b> coffee brown Bavaria oak stained</p> <p><b>Surface</b> Veneer sealed with high-quality lacquer</p>  <p><b>XL 6834</b></p> <p><b>Reference carcass</b> K075P Black</p> <p><b>Visible sides</b> Z214K coffee brown stained</p>	<p><b>Front decor</b> Gavi Bavaria oak, stained</p> <p><b>Surface</b> Veneer sealed with high-quality lacquer</p>  <p><b>XL 6838</b></p> <p><b>Reference carcass</b> K230P Art Pepper</p> <p><b>Visible sides</b> Z258K Gavi oak veneer</p>	<p><b>Front decor</b> Bavaria oak Light Pepper lacquered</p> <p><b>Surface</b> Veneer sealed with high-quality lacquer</p>  <p><b>XL 6839</b></p> <p><b>Reference carcass</b> K218P Light Pepper</p> <p><b>Visible sides</b> Z218S Light Pepper lacquered</p>
<p><b>Front decor</b> silky grey Bavaria oak stained</p> <p><b>Surface</b> Veneer sealed with high-quality lacquer</p>  <p><b>XL 6840</b></p> <p><b>Reference carcass</b> K230P Art Pepper</p> <p><b>Visible sides</b> Z058K Silky grey, stained</p>	<p><b>Front decor</b> graphite black Bavaria oak lacquered</p> <p><b>Surface</b> Veneer sealed with high-quality lacquer</p>  <p><b>XL 6845</b></p> <p><b>Reference carcass</b> K043P Graphite Black</p> <p><b>Visible sides</b> Z043S Graphite Black Lacquered</p>	<p><b>Front decor</b> Bavaria oak Art Pepper lacquered</p> <p><b>Surface</b> Veneer sealed with high-quality lacquer</p>  <p><b>XL 6847</b></p> <p><b>Reference carcass</b> K230P Art Pepper</p> <p><b>Visible sides</b> Z230S Art Pepper lacquered</p>
<p><b>Front decor</b> dark Bavaria oak, stained</p> <p><b>Surface</b> Veneer sealed with high-quality lacquer</p>  <p><b>XL 6851</b></p> <p><b>Reference carcass</b> K075P Black</p> <p><b>Visible sides</b> Z259K Dark oak stained</p>	<p><b>Front decor</b> Macaron Bavaria oak lacquered</p> <p><b>Surface</b> Veneer sealed with high-quality lacquer</p>  <p><b>XL 6852</b></p> <p><b>Reference carcass</b> K076P Macaron</p> <p><b>Visible sides</b> Z076K Macaron lacquered</p>	<p><b>Front decor</b> Light Nude Bavaria oak, lacquered</p> <p><b>Surface</b> Veneer sealed with high-quality lacquer</p>  <p><b>XL 6856</b></p> <p><b>Reference carcass</b> K248P Light Nude</p> <p><b>Visible sides</b> Z248S Light Nude lacquered</p>





**XL 60144**

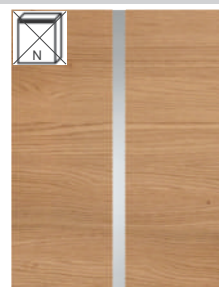
**Front decor** Bavaria oak Urban Oak stained (rear in same colour)  
**Surface** Veneer sealed with high-quality lacquer  
**Front thickness** 20 mm  
**Door shape** 12,757 kg/sqm excluding handle weight (see handles) straight, 4 sides with thick oak veneer edge 1.5 mm  
**Front material** Multi-layer particle board, oak veneer on both sides, rear smooth

**Quality description:**  
 The veneer pattern includes small knot flecks in various forms.

**Available glass doors for specific models**

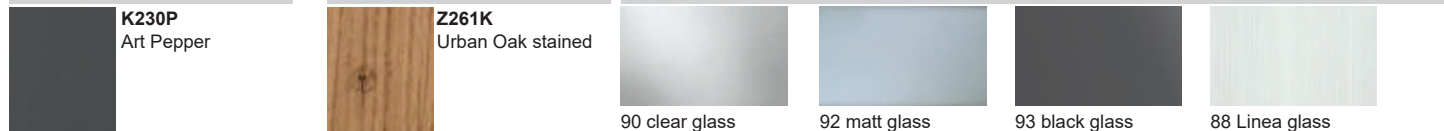


**Semi-frameless glass door...**  
 e.g. HG 50 78 34 LS

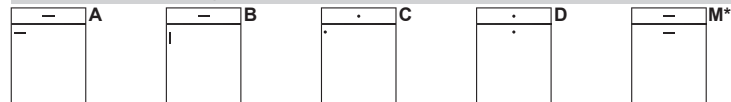


**Semi-frameless glass door / glass width 5 cm...**  
 e.g. HG 50 78 34 LB

**Reference carcase** **Visible sides** **Available glass versions**

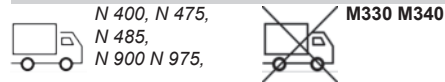


**Available handle arrangements**



\* = Standard finish

**Grip ledges** **Handles** **cornices / light pelmets**



**Front decor** Bavaria oak veneer special colours  
**Surface** Veneer sealed with high-quality lacquer

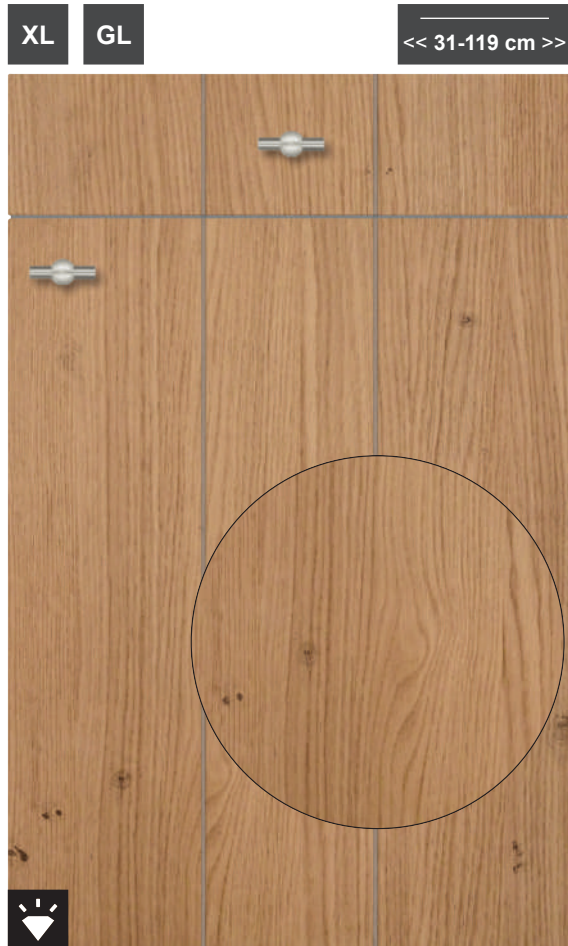
**XL 60199**

**Reference carcase**  
 K230P Art Pepper

**Visible sides**  
 Z099K special colour lacquered

Colour concept at no extra charge	
Sealbrown RAL 8019	Cristal red SIKKENS C0.60.30
Savona green SIKKENS K0.05.47	Victoria green RAL 180 30 10
Night Red SIKKENS C0.20.20	Blackblue SIKKENS U0.10.20
Jade, pastel RAL 7032 <b>NEW</b>	live simple! No. 8 <b>NEW</b>

<p><b>Front decor</b> Premium white lacquered Bavaria oak</p> <p><b>Surface</b> Veneer sealed with high-quality lacquer</p>  <p><b>XL 60120</b></p> <p><b>Reference carcass</b> K039P Premium white</p> <p><b>Visible sides</b> Z039S premium white lacquer</p>	<p><b>Front decor</b> Bavaria oak stained Moderno Rustico</p> <p><b>Surface</b> Veneer sealed with high-quality lacquer</p>  <p><b>XL 60121</b></p> <p><b>Quality description:</b> The veneer pattern includes small knot flecks in various forms.</p> <p><b>Reference carcass</b> K230P Art Pepper</p> <p><b>Visible sides</b> Z279K Moderno Rustico, stained</p>	<p><b>Front decor</b> black lacquered Bavaria oak</p> <p><b>Surface</b> Veneer sealed with high-quality lacquer</p>  <p><b>XL 60125</b></p> <p><b>Reference carcass</b> K075P Black</p> <p><b>Visible sides</b> Z075S black lacquer</p>
<p><b>Front decor</b> Fango Bavaria oak, lacquered</p> <p><b>Surface</b> Veneer sealed with high-quality lacquer</p>  <p><b>XL 60127</b></p> <p><b>Reference carcass</b> K263P Fango</p> <p><b>Visible sides</b> Z263S Fango, lacquered</p>	<p><b>Front decor</b> Bavaria oak Night Green lacquered</p> <p><b>Surface</b> Veneer sealed with high-quality lacquer</p>  <p><b>XL 60129</b></p> <p><b>Reference carcass</b> K075P Black</p> <p><b>Visible sides</b> Z245S Night Green lacquered</p>	<p><b>Front decor</b> dark Bavaria oak, stained</p> <p><b>Surface</b> Veneer sealed with high-quality lacquer</p>  <p><b>XL 60141</b></p> <p><b>Reference carcass</b> K075P Black</p> <p><b>Visible sides</b> Z259K Dark oak stained</p>
<p><b>Front decor</b> Macaron Bavaria oak lacquered</p> <p><b>Surface</b> Veneer sealed with high-quality lacquer</p>  <p><b>XL 60145</b></p> <p><b>Reference carcass</b> K076P Macaron</p> <p><b>Visible sides</b> Z076K Macaron lacquered</p>	<p><b>Front decor</b> Light Nude Bavaria oak, lacquered</p> <p><b>Surface</b> Veneer sealed with high-quality lacquer</p>  <p><b>XL 60146</b></p> <p><b>Reference carcass</b> K248P Light Nude</p> <p><b>Visible sides</b> Z248S Light Nude lacquered</p>	<p><b>Front decor</b> Gavi Bavaria oak, stained</p> <p><b>Surface</b> Veneer sealed with high-quality lacquer</p>  <p><b>XL 60148</b></p> <p><b>Reference carcass</b> K230P Art Pepper</p> <p><b>Visible sides</b> Z258K Gavi oak veneer</p>
<p><b>Front decor</b> Bavaria oak Light Pepper lacquered</p> <p><b>Surface</b> Veneer sealed with high-quality lacquer</p>  <p><b>XL 60160</b></p> <p><b>Reference carcass</b> K218P Light Pepper</p> <p><b>Visible sides</b> Z218S Light Pepper lacquered</p>	<p><b>Front decor</b> silky grey Bavaria oak stained</p> <p><b>Surface</b> Veneer sealed with high-quality lacquer</p>  <p><b>XL 60165</b></p> <p><b>Reference carcass</b> K230P Art Pepper</p> <p><b>Visible sides</b> Z058K Sily grey, stained</p>	<p><b>Front decor</b> untreated Bavaria oak stained</p> <p><b>Surface</b> Veneer sealed with high-quality lacquer</p>  <p><b>XL 60170</b></p> <p><b>Reference carcass</b> K230P Art Pepper</p> <p><b>Visible sides</b> Z213K untreated stained</p>
<p><b>Front decor</b> coffee brown Bavaria oak stained</p> <p><b>Surface</b> Veneer sealed with high-quality lacquer</p>  <p><b>XL 60175</b></p> <p><b>Reference carcass</b> K075P Black</p> <p><b>Visible sides</b> Z214K coffee brown stained</p>	<p><b>Front decor</b> graphite black Bavaria oak lacquered</p> <p><b>Surface</b> Veneer sealed with high-quality lacquer</p>  <p><b>XL 60180</b></p> <p><b>Reference carcass</b> K043P Graphite Black</p> <p><b>Visible sides</b> Z043S Graphite Black Lacquered</p>	<p><b>Front decor</b> Bavaria oak Art Pepper lacquered</p> <p><b>Surface</b> Veneer sealed with high-quality lacquer</p>  <p><b>XL 60185</b></p> <p><b>Reference carcass</b> K230P Art Pepper</p> <p><b>Visible sides</b> Z230S Art Pepper lacquered</p>



**XL 6884**

**Front decor** Bavaria oak Urban Oak stained (rear in same colour)  
**Surface** Veneer sealed with high-quality lacquer  
**Front thickness** 20 mm  
 14,054 kg/sqm excluding handle weight (see handles)  
**Door shape** straight, 4 sides with thick oak veneer edge 1.5 mm, vertical grooving 150 mm  
**Front material** Multi-layer particle board, oak veneer on both sides, rear smooth

**Note:**  
 Width 20 cm is supplied with smooth fronts

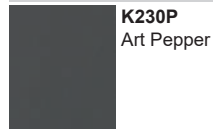
**Quality description:**  
 The veneer pattern includes small knot flecks in various forms.

**Available glass doors for specific models**

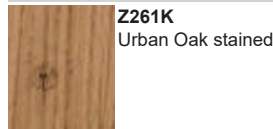


**Semi-frameless glass door...**  
 e.g. HG 50 78 34 LS

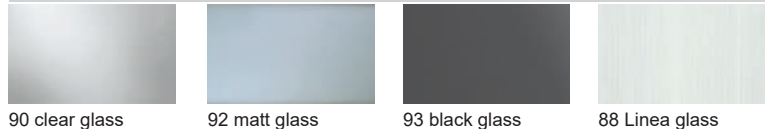
**Reference carcass**



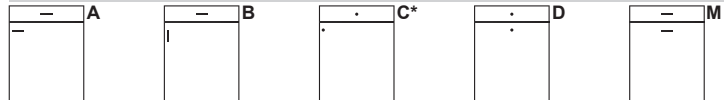
**Visible sides**



**Available glass versions**

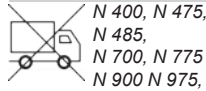


**Available handle arrangements**



\* = Standard finish

**Grip ledges**



**Handles**



M330 M340

**cornices / light pelmets**

**Front decor** Bavaria oak veneer special colours

**Surface** Veneer sealed with high-quality lacquer

**XL 6899**



**Reference carcass**  
**K230P**  
 Art Pepper


**Visible sides**  
**Z099K**  
 special colour lacquered

**Colour concept at no extra charge**

Sealbrown RAL 8019	Cristal red SIKKENS C0.60.30
Savona green SIKKENS K0.05.47	Victoria green RAL 180 30 10
Night Red SIKKENS C0.20.20	Blackblue SIKKENS U0.10.20
Jade, pastel RAL 7032 <b>NEW</b>	live simple! No. 8 <b>NEW</b>



**Front decor** black lacquered Bavaria oak  
**Surface** Veneer sealed with high-quality lacquer




**XL 6864**

**Reference carcass**  
 K075P  
 Black

**Visible sides**  
 Z075S  
 black lacquer

**Front decor** Premium white lacquered Bavaria oak  
**Surface** Veneer sealed with high-quality lacquer

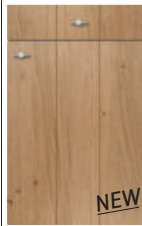


**XL 6862**

**Reference carcass**  
 K039P  
 Premium white

**Visible sides**  
 Z039S  
 premium white lacquer

**Front decor** Gavi Bavaria oak, stained  
**Surface** Veneer sealed with high-quality lacquer




**XL 6865**

**Reference carcass**  
 K230P  
 Art Pepper

**Visible sides**  
 Z258K  
 Gavi oak veneer

**Front decor** Bavaria oak Light Pepper lacquered  
**Surface** Veneer sealed with high-quality lacquer

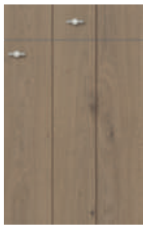


**XL 6869**

**Reference carcass**  
 K218P  
 Light Pepper

**Visible sides**  
 Z218S  
 Light Pepper lacquered

**Front decor** silky grey Bavaria oak stained  
**Surface** Veneer sealed with high-quality lacquer

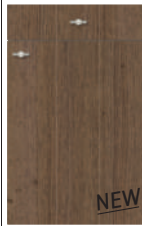


**XL 6870**

**Reference carcass**  
 K043P  
 Graphite Black

**Visible sides**  
 Z058K  
 Sily grey, stained

**Front decor** Bavaria oak stained Moderno Rustico  
**Surface** Veneer sealed with high-quality lacquer




**XL 6871**

**Reference carcass**  
 K230P  
 Art Pepper

**Visible sides**  
 Z279K  
 Moderno Rustico, stained

**Front decor** Macaron Bavaria oak lacquered  
**Surface** Veneer sealed with high-quality lacquer



**XL 6874**

**Reference carcass**  
 K076P  
 Macaron

**Visible sides**  
 Z076K  
 Macaron lacquered

**Front decor** dark Bavaria oak, stained  
**Surface** Veneer sealed with high-quality lacquer




**XL 6875**

**Reference carcass**  
 K075P  
 Black

**Visible sides**  
 Z259K  
 Dark oak stained

**Front decor** untreated Bavaria oak stained  
**Surface** Veneer sealed with high-quality lacquer




**XL 6878**

**Reference carcass**  
 K230P  
 Art Pepper

**Visible sides**  
 Z213K  
 untreated stained

**Front decor** Bavaria oak Night Green lacquered  
**Surface** Veneer sealed with high-quality lacquer



**XL 6879**

**Reference carcass**  
 K075P  
 Black

**Visible sides**  
 Z245S  
 Night Green lacquered

**Front decor** coffee brown Bavaria oak stained  
**Surface** Veneer sealed with high-quality lacquer

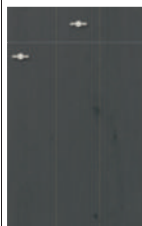


**XL 6880**

**Reference carcass**  
 K075P  
 Black

**Visible sides**  
 Z214K  
 coffee brown stained

**Front decor** Bavaria oak Art Pepper lacquered  
**Surface** Veneer sealed with high-quality lacquer




**XL 6882**

**Reference carcass**  
 K230P  
 Art Pepper

**Visible sides**  
 Z230S  
 Art Pepper lacquered

**Front decor** Light Nude Bavaria oak, lacquered  
**Surface** Veneer sealed with high-quality lacquer

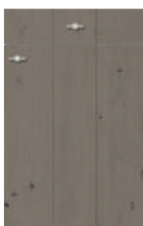


**XL 6886**

**Reference carcass**  
 K248P  
 Light Nude

**Visible sides**  
 Z248S  
 Light Nude lacquered

**Front decor** Fango Bavaria oak, lacquered  
**Surface** Veneer sealed with high-quality lacquer

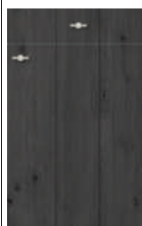


**XL 6887**

**Reference carcass**  
 K263P  
 Fango

**Visible sides**  
 Z263S  
 Fango, lacquered

**Front decor** graphite black Bavaria oak lacquered  
**Surface** Veneer sealed with high-quality lacquer



**XL 6872**

**Reference carcass**  
 K043P  
 Graphite Black

**Visible sides**  
 Z043S  
 Graphite Black Lacquered



**XL 6265**

**Front decor** Macaron oak lacquered (rear in same colour)  
**Surface** Veneer sealed with high-quality lacquer  
**Front thickness** 19 mm  
**Door shape** 9,730 kg/sqm excluding handle weight (see handles)  
 Coffered front, frame width 90 mm  
**Front material** Multi-layer particle board, frame and centre panel oak veneer

**Note:**  
 Width 15 cm is supplied with smooth fronts  
 Width 20 cm is supplied with smooth fronts

**Available glass doors for specific models**



Framed glass door...  
 e.g. HG 50 78 34 RA

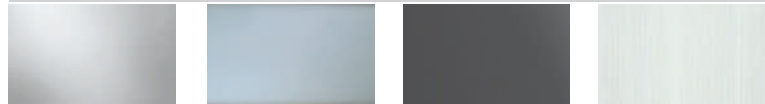
**Reference carcass**

**K076P**  
 Macaron

**Visible sides**

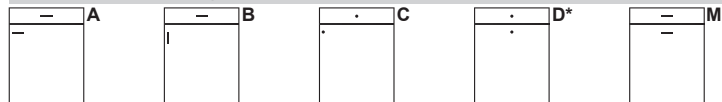
**F076K**  
 Macaron lacquered

**Available glass versions**



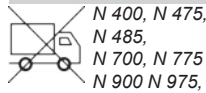
90 clear glass    92 matt glass    93 black glass    88 Linea glass

**Available handle arrangements**



\* = Standard finish

**Grip ledges**



N 400, N 475,  
 N 485,  
 N 700, N 775  
 N 900 N 975,

**Handles**



M330 M340

**cornices / light pelmets**

**Front decor** Special colour oak veneer  
**Surface** Veneer sealed with high-quality lacquer

**XL 6249**




**Reference carcass**  
**K230P**  
 Art Pepper

**Visible sides**  
**F099K**  
 special colour lacquered

**Colour concept at no extra charge**

Sealbrown RAL 8019	Cristal red SIKKENS C0.60.30
Savona green SIKKENS K0.05.47	Victoria green RAL 180 30 10
Night Red SIKKENS C0.20.20	Blackblue SIKKENS U0.10.20
Jade, pastel RAL 7032 <b>NEW</b>	live simple! No. 8 <b>NEW</b>

**Front decor** Premium white lacquered oak  
**Surface** Veneer sealed with high-quality lacquer



**XL 6220**

**Reference carcass**  
**K039P**  
 Premium white

**Visible sides**  
**F039S**  
 premium white lacquer

**Front decor** Moderno Rustico oak stained  
**Surface** Veneer sealed with high-quality lacquer




**XL 6221**

**Reference carcass**  
**K230P**  
 Art Pepper

**Visible sides**  
**F279K**  
 Moderno Rustico, stained

**Front decor** Urban Oak Stained  
**Surface** Veneer sealed with high-quality lacquer




**XL 6224**

**Reference carcass**  
**K230P**  
 Art Pepper

**Visible sides**  
**F261K**  
 Urban Oak stained

**Front decor** black lacquered oak  
**Surface** Veneer sealed with high-quality lacquer




**XL 6225**

**Reference carcass**  
**K075P**  
 Black

**Visible sides**  
**F075S**  
 black lacquer

**Front decor** Eiche Light Nude lacquered  
**Surface** Veneer sealed with high-quality lacquer

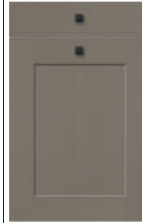


**XL 6226**

**Reference carcass**  
**K248P**  
 Light Nude

**Visible sides**  
**F248S**  
 Light Nude lacquered

**Front decor** Fango oak, lacquered  
**Surface** Veneer sealed with high-quality lacquer




**XL 6227**

**Reference carcass**  
**K263P**  
 Fango

**Visible sides**  
**F263S**  
 Fango, lacquered

**Front decor** Gavi oak veneer  
**Surface** Veneer sealed with high-quality lacquer




**XL 6228**

**Reference carcass**  
**K230P**  
 Art Pepper

**Visible sides**  
**F258K**  
 Gavi oak veneer

**Front decor** Oak Night Green lacquered  
**Surface** Veneer sealed with high-quality lacquer

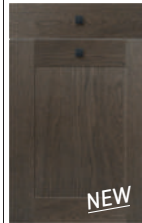


**XL 6229**

**Reference carcass**  
**K075P**  
 Black

**Visible sides**  
**F245S**  
 Night Green lacquered

**Front decor** Dark oak stained  
**Surface** Veneer sealed with high-quality lacquer




**XL 6231**

**Reference carcass**  
**K075P**  
 Black

**Visible sides**  
**F259K**  
 Dark oak stained

**Front decor** oak Art Pepper lacquered  
**Surface** Veneer sealed with high-quality lacquer




**XL 6240**

**Reference carcass**  
**K230P**  
 Art Pepper

**Visible sides**  
**F230S**  
 Art Pepper lacquered

**Front decor** oak Light Pepper lacquered  
**Surface** Veneer sealed with high-quality lacquer




**XL 6269**

**Reference carcass**  
**K218P**  
 Light Pepper

**Visible sides**  
**F218S**  
 Light Pepper lacquered

**Front decor** oak stained silky grey  
**Surface** Veneer sealed with high-quality lacquer




**XL 6270**

**Reference carcass**  
**K043P**  
 Graphite Black

**Visible sides**  
**F058K**  
 silk grey

**Front decor** untreated oak, stained  
**Surface** Veneer sealed with high-quality lacquer

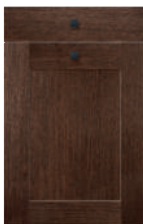


**XL 6275**

**Reference carcass**  
**K230P**  
 Art Pepper

**Visible sides**  
**F213K**  
 natural

**Front decor** coffee brown oak stained  
**Surface** Veneer sealed with high-quality lacquer




**XL 6278**

**Reference carcass**  
**K075P**  
 Black

**Visible sides**  
**F214K**  
 coffee brown

**Front decor** graphite black oak lacquered  
**Surface** Veneer sealed with high-quality lacquer

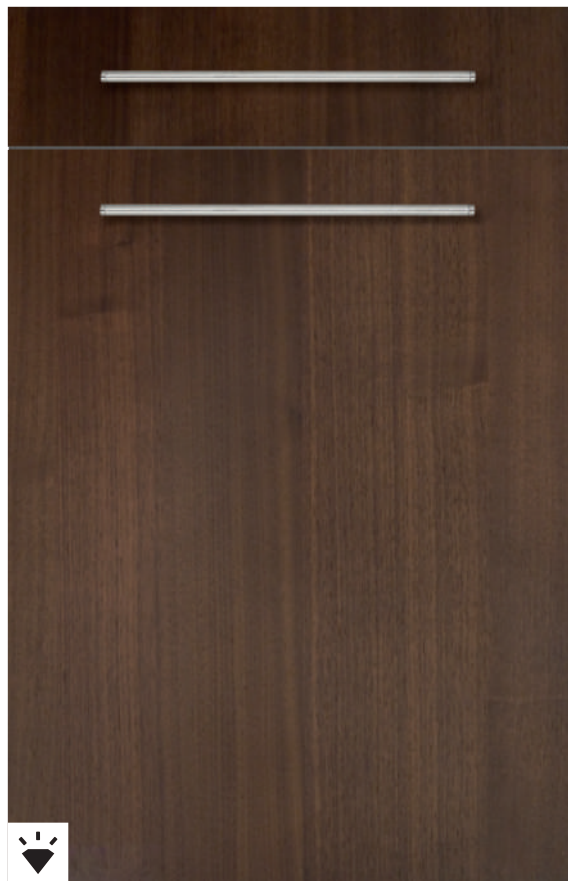


**XL 6295**

**Reference carcass**  
**K043P**  
 Graphite Black

**Visible sides**  
**F043S**  
 Graphite Black Lacquered

XL GL << 31-119 cm >>



**XL 6810**

**Front decor** walnut stained (rear in same colour)  
**Surface** Veneer sealed with high-quality lacquer  
**Front thickness** 19 mm  
**Door shape** 12,757 kg/sqm excluding handle weight (see handles) straight, 4 sides with walnut thick veneer edge 1.5 mm  
**Front material** multi-layer particle board, walnut veneer on both sides, vertical grain pattern

**Note:**  
 Because the FLORENZ and MODENA models are high-quality natural products, there may be differences in the structure and colour between individual fronts and surrounding materials. These are characteristic of real wood materials and do not constitute grounds for complaint. Changes to the veneer colour due to UV effects of natural sunlight are unavoidable. Depending on light exposure, individual elements can appear optically different (in artificial and natural light).

**Available glass doors for specific models**



**Semi-frameless glass door...**  
 e.g. HG 50 78 34 LS

**Semi-frameless glass door / glass width 5 cm...**  
 e.g. HG 50 78 34 LB

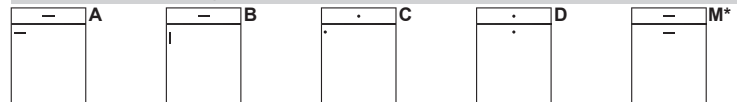
**Reference carcase**  
 K075P  
 Black

**Visible sides**  
 F231K  
 walnut stained

**Available glass versions**

90 clear glass	92 matt glass	93 black glass	88 Linea glass

**Available handle arrangements**



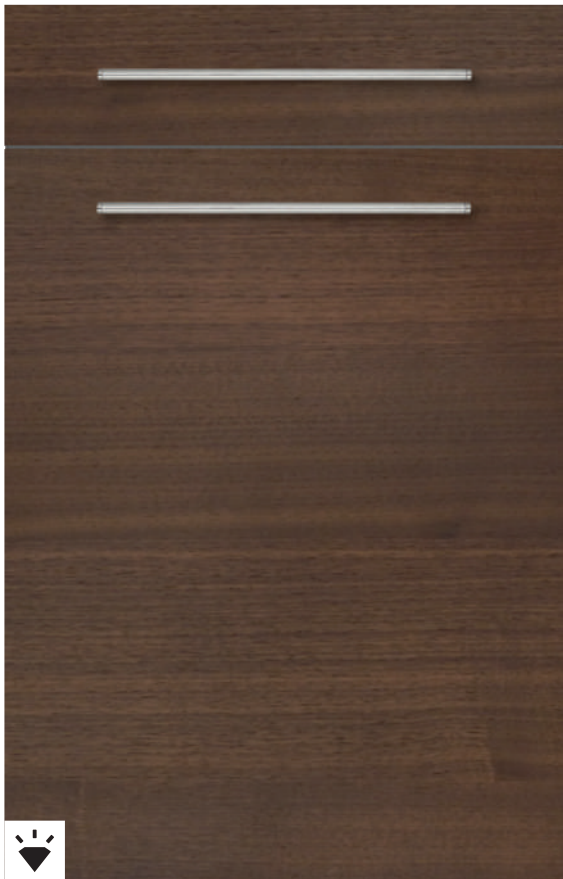
\* = Standard finish

<b>Grip ledges</b>	<b>Handles</b>	<b>cornices / light pelmets</b>
N 400, N 475, N 485, N 900 N 975,	M330 M340	

XL

GL

<< 31-119 cm >>



**XL 6815**

- Front decor** walnut stained (rear in same colour)
- Surface** Veneer sealed with high-quality lacquer
- Front thickness** 19 mm
- Door shape** 12,757 kg/sqm excluding handle weight (see handles)  
straight, 4 sides with walnut thick veneer edge 1.5 mm
- Front material** multi-layer particle board, both sides walnut veneer, horizontal grain pattern

**Note:**  
Because the FLORENZ and MODENA models are high-quality natural products, there may be differences in the structure and colour between individual fronts and surrounding materials. These are characteristic of real wood materials and do not constitute grounds for complaint. Changes to the veneer colour due to UV effects of natural sunlight are unavoidable. Depending on light exposure, individual elements can appear optically different (in artificial and natural light).

**Available glass doors for specific models**

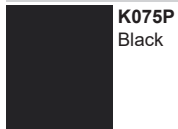


**Semi-frameless glass door...**  
e.g. HG 50 78 34 LS



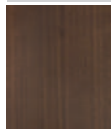
**Semi-frameless glass door / glass width 5 cm...**  
e.g. HG 50 78 34 LB

**Reference carcass**



**K075P**  
Black

**Visible sides**



**F231K**  
walnut stained

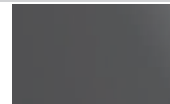
**Available glass versions**



90 clear glass



92 matt glass

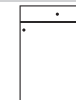
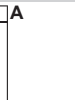
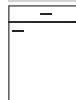


93 black glass



88 Linea glass

**Available handle arrangements**



\* = Standard finish

**Grip ledges**



N 400, N 475,  
N 485,  
N 900 N 975,

**Handles**



M330  
M340

**cornices / light pelmets**



**XL** **GL** << 31-119 cm >>



**XL 6100**

**Front decor** Dark oak stained, brushed  
(rear in same colour)  
**Surface** Veneer sealed with high-quality lacquer  
**Front thickness** 19 mm  
 12,527 kg/sqm excluding handle weight (see handles)  
**Door shape** straight, 4 sides with thick oak veneer edge 1.5 mm  
**Front material** Multi-layer particle board, oak veneer on both sides

**Available glass doors for specific models**



**Semi-frameless glass door...**  
e.g. HG 50 78 34 LS

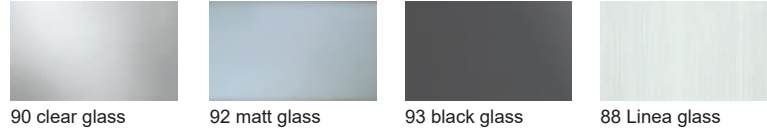
**Reference carcase**

**K043P**  
Graphite Black

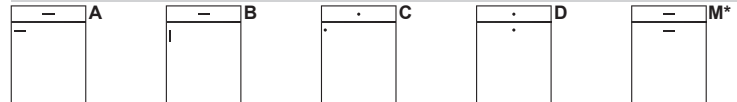
**Visible sides**

**O259K**  
Dark oak stained

**Available glass versions**

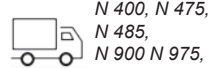


**Available handle arrangements**



\* = Standard finish

**Grip ledges**



N 400, N 475,  
N 485,  
N 900 N 975,

**Handles**



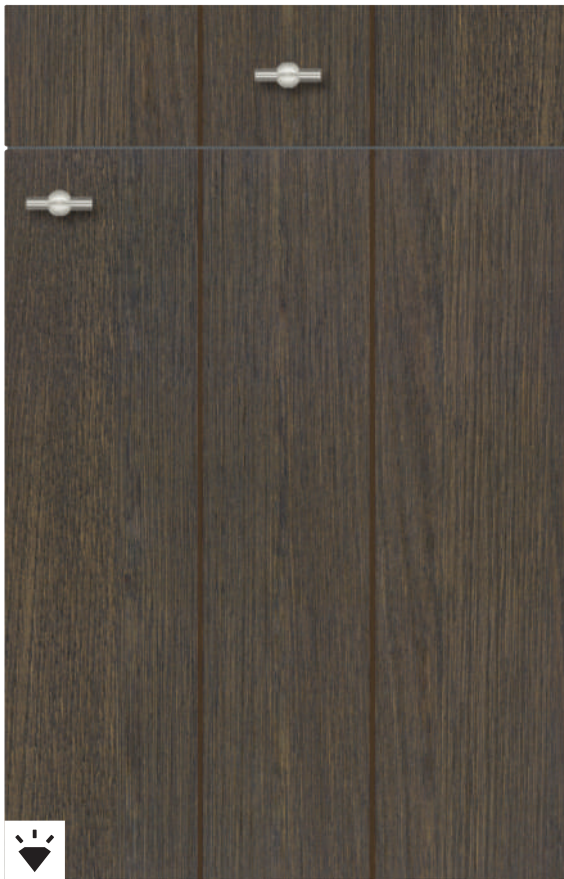
M330  
M340

**cornices / light pelmets**

XL

GL

<< 31-119 cm >>



**XL 6700**

- Front decor** Dark oak stained, brushed (rear in same colour)
- Surface** Veneer sealed with high-quality lacquer
- Front thickness** 19 mm
- Door shape** 12,527 kg/sqm excluding handle weight (see handles) straight, 4 sides with thick oak veneer edge 1.5 mm, vertical grooving 150 mm
- Front material** Multi-layer particle board, oak veneer on both sides

**Note:**  
Width 20 cm is supplied with smooth fronts

**Available glass doors for specific models**



**Semi-frameless glass door...**  
e.g. HG 50 78 34 LS

**Reference carcass**

**K043P**  
Graphite Black

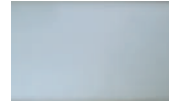
**Visible sides**

**O259K**  
Dark oak stained

**Available glass versions**



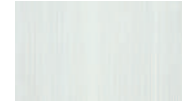
90 clear glass



92 matt glass



93 black glass



88 Linea glass

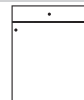
**Available handle arrangements**



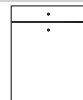
A



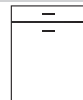
B



C\*



D



M

\* = Standard finish

**Grip ledges**



N 400, N 475,  
N 485,  
N 900 N 975,  
N 700, N 775

**Handles**



M330  
M340

**cornices / light pelmets**



XL

GL

&lt;&lt; 31-119 cm &gt;&gt;

**XL 61050**

<b>Front decor</b>	premium white (rear in same colour)
<b>Surface</b>	Soft lacquer
<b>Front thickness</b>	19 mm
<b>Door shape</b>	14,669 kg/sqm excluding handle weight (see handles) modern frame front, frame width 80 mm
<b>Front material</b>	MDF substrate with high-quality lacquered surface

**Note:**  
Width 15 cm is supplied with smooth fronts

**Available glass doors for specific models**

**Framed glass door...**  
e.g. HG 50 78 34 RA

**Reference carcase**

**K039P**  
Premium white

**Visible sides**

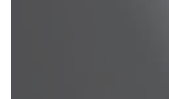
**P039M**  
Premium white

**Available glass versions**

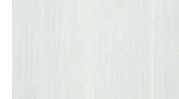
90 clear glass



92 matt glass



93 black glass



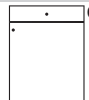
88 Linea glass

**Available handle arrangements**

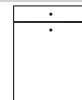
A



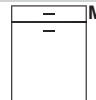
B\*



C



D



M

\* = Standard finish


**Grip ledges**


N 400, N 475,  
N 485,  
N 700, N 775  
N 900 N 975,


**Handles**


M330 M340


**cornices / light pelmets**


**Front decor** snow white  
**Surface** Soft lacquer  
**XL 61046**  
  
**Reference carcass**  
**K160F**  
 Snow white  
**Visible sides**


**Front decor** White Agate  
**Surface** Soft lacquer  
**XL 61056**  
  
**Reference carcass**  
**K178F**  
 White Agate  
**Visible sides**


**Front decor** Night Green  
**Surface** Soft lacquer  
**XL 61059**  
  
**Reference carcass**  
**K075P**  
 Black  
**Visible sides**


**Front decor** light grey  
**Surface** Soft lacquer  
**XL 61060**  
  
**Reference carcass**  
**K006P**  
 Light Grey  
**Visible sides**


**Front decor** Art Pepper  
**Surface** Soft lacquer  
**XL 61062**  
  
**Reference carcass**  
**K230P**  
 Art Pepper  
**Visible sides**


**Front decor** Macaron  
**Surface** Soft lacquer  
**XL 61065**  
  
**Reference carcass**  
**K076P**  
 Macaron  
**Visible sides**

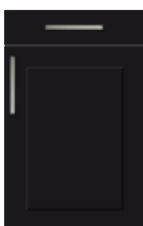
**Front decor** Light Nude  
**Surface** Soft lacquer  
**XL 61066**  
  
**Reference carcass**  
**K248P**  
 Light Nude  
**Visible sides**


**Front decor** Fango  
**Surface** Soft lacquer  
**XL 61067**  
  
**Reference carcass**  
**K263P**  
 Fango  
**Visible sides**

**Front decor** Light Pepper  
**Surface** Soft lacquer  
**XL 61069**  
  
**Reference carcass**  
**K218P**  
 Light Pepper  
**Visible sides**

**Front decor** magic grey  
**Surface** Soft lacquer  
**XL 61084**  
  
**Reference carcass**  
**K058P**  
 Magic-grey  
**Visible sides**

**Front decor** graphite black  
**Surface** Soft lacquer  
**XL 61095**  
  
**Reference carcass**  
**K043P**  
 Graphite Black  
**Visible sides**

**Front decor** black  
**Surface** Soft lacquer  
**XL 61098**  
  
**Reference carcass**  
**K075P**  
 Black  
**Visible sides**

**Front decor** special colour  
**Surface** Soft lacquer  
**XL 61099**  
  
**Reference carcass**  
**K023P**  
 Stainless Steel Colour  
**Visible sides**

**Colour concept at no extra charge**

 Sealbrown RAL 8019	 Cristal red SIKKENS C0.60.30
 Savona green SIKKENS K0.05.47	 Victoria green RAL 180 30 10
 Night Red SIKKENS C0.20.20	 Blackblue SIKKENS U0.10.20
 Jade, pastel RAL 7032	 live simple! No. 8



XL

GL

<< 31-119 cm >>

**XL 67169**

**Front decor** Light Pepper  
(rear in same colour)  
**Surface** Micro textured lacquer  
**Front thickness** 19 mm  
**Door shape** 14,200 kg/sqm excluding handle weight (see handles)  
 framed front, frame width 12 mm with additional inner frame 75 mm starting from the outer edge, frame angled 67.5° to the inside  
**Front material** MDF substrate with high-quality lacquered surface

**NEW**

**Note:**  
Range always without tightening fitting!

**Available glass doors for specific models**



Framed glass door...  
e.g. HG 50 78 34 RA

**Reference carcase**

**K218P**  
Light Pepper

**Visible sides**

**S218P**  
Light Pepper

**Available glass versions**



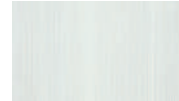
90 clear glass



92 matt glass

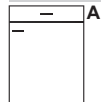


93 black glass



88 Linea glass

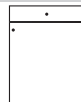
**Available handle arrangements**



A



B



C



D



M\*

\* = Standard finish

**Grip ledges**




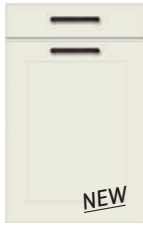





N 400, N 475,  
N 485,  
N 900 N 975,  
N 700, N 775

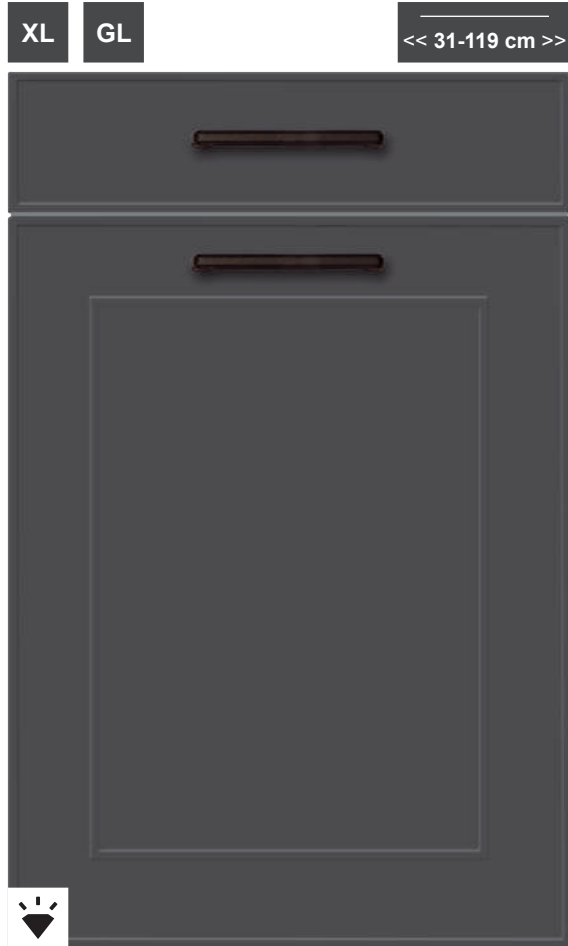
**Handles**



M330  
M340  
G320  
G321  
G370  
G371  
G024

**cornices / light pelmets**

<p><b>Front decor</b> snow white</p> <p><b>Surface</b> Micro textured lacquer</p>  <p><b>XL 67146</b></p> <p><b>Reference carcass</b> K160F Snow white</p> <p><b>Visible sides</b> S160P Snow White</p>	<p><b>Front decor</b> premium white</p> <p><b>Surface</b> Micro textured lacquer</p>  <p><b>XL 67150</b></p> <p><b>Reference carcass</b> K039P Premium white</p> <p><b>Visible sides</b> S039P Premium white</p>	<p><b>Front decor</b> White Agate</p> <p><b>Surface</b> Micro textured lacquer</p>  <p><b>XL 67156</b></p> <p><b>Reference carcass</b> K178F White Agate</p> <p><b>Visible sides</b> S178P White Agate</p>								
<p><b>Front decor</b> Night Green</p> <p><b>Surface</b> Micro textured lacquer</p>  <p><b>XL 67159</b></p> <p><b>Reference carcass</b> K075P Black</p> <p><b>Visible sides</b> S245P Night Green</p>	<p><b>Front decor</b> light grey</p> <p><b>Surface</b> Micro textured lacquer</p>  <p><b>XL 67160</b></p> <p><b>Reference carcass</b> K006P Light Grey</p> <p><b>Visible sides</b> S006P Light Grey</p>	<p><b>Front decor</b> Art Pepper</p> <p><b>Surface</b> Micro textured lacquer</p>  <p><b>XL 67162</b></p> <p><b>Reference carcass</b> K230P Art Pepper</p> <p><b>Visible sides</b> S230P Art Pepper</p>								
<p><b>Front decor</b> Macaron</p> <p><b>Surface</b> Micro textured lacquer</p>  <p><b>XL 67165</b></p> <p><b>Reference carcass</b> K076P Macaron</p> <p><b>Visible sides</b> S076P Macaron</p>	<p><b>Front decor</b> Light Nude</p> <p><b>Surface</b> Micro textured lacquer</p>  <p><b>XL 67166</b></p> <p><b>Reference carcass</b> K248P Light Nude</p> <p><b>Visible sides</b> S248P Light Nude</p>	<p><b>Front decor</b> Fango</p> <p><b>Surface</b> Micro textured lacquer</p>  <p><b>XL 67167</b></p> <p><b>Reference carcass</b> K263P Fango</p> <p><b>Visible sides</b> S263P Fango</p>								
<p><b>Front decor</b> magic grey</p> <p><b>Surface</b> Micro textured lacquer</p>  <p><b>XL 67184</b></p> <p><b>Reference carcass</b> K058P Magic-grey</p> <p><b>Visible sides</b> S058P Magic-grey</p>	<p><b>Front decor</b> graphite black</p> <p><b>Surface</b> Micro textured lacquer</p>  <p><b>XL 67195</b></p> <p><b>Reference carcass</b> K043P Graphite Black</p> <p><b>Visible sides</b> S043P Graphite Black</p>	<p><b>Front decor</b> black</p> <p><b>Surface</b> Micro textured lacquer</p>  <p><b>XL 67198</b></p> <p><b>Reference carcass</b> K075P Black</p> <p><b>Visible sides</b> S075P Black</p>								
<p><b>Front decor</b> special colour</p> <p><b>Surface</b> Micro textured lacquer</p>  <p><b>XL 67199</b></p> <p><b>Reference carcass</b> K023P Stainless Steel Colour</p> <p><b>Visible sides</b> S099P special colour</p>	<p style="text-align: center;"><b>Colour concept at no extra charge</b></p> <table border="1"> <tbody> <tr> <td data-bbox="595 1751 831 1841">Sealbrown RAL 8019</td> <td data-bbox="831 1751 1062 1841">Cristal red SIKKENS C0.60.30</td> </tr> <tr> <td data-bbox="595 1841 831 1930">Savona green SIKKENS K0.05.47</td> <td data-bbox="831 1841 1062 1930">Victoria green RAL 180 30 10</td> </tr> <tr> <td data-bbox="595 1930 831 2020">Night Red SIKKENS C0.20.20</td> <td data-bbox="831 1930 1062 2020">Blackblue SIKKENS U0.10.20</td> </tr> <tr> <td data-bbox="595 2020 831 2096">Jade, pastel RAL 7032</td> <td data-bbox="831 2020 1062 2096">live simple! No. 8</td> </tr> </tbody> </table>		Sealbrown RAL 8019	Cristal red SIKKENS C0.60.30	Savona green SIKKENS K0.05.47	Victoria green RAL 180 30 10	Night Red SIKKENS C0.20.20	Blackblue SIKKENS U0.10.20	Jade, pastel RAL 7032	live simple! No. 8
Sealbrown RAL 8019	Cristal red SIKKENS C0.60.30									
Savona green SIKKENS K0.05.47	Victoria green RAL 180 30 10									
Night Red SIKKENS C0.20.20	Blackblue SIKKENS U0.10.20									
Jade, pastel RAL 7032	live simple! No. 8									



**XL**

**GL**

<< 31-119 cm >>

**XL 68162**

- Front decor** Art Pepper (rear in same colour)
- Surface** Velvet lacquer
- Front thickness** 19 mm
- Door shape** 14,200 kg/sqm excluding handle weight (see handles)  
framed front, frame width 12 mm with additional inner frame 75 mm starting from the outer edge, frame angled 67.5° to the inside
- Front material** MDF substrate with high-quality lacquered surface

**NEW**

**Note:**  
Range always without tightening fitting!

**Available glass doors for specific models**



Framed glass door...  
e.g. HG 50 78 34 RA

**Reference carcase**

**K230P**  
Art Pepper

**Visible sides**

**B230F**  
Art Pepper

**Available glass versions**



90 clear glass



92 matt glass

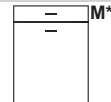
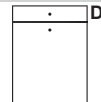
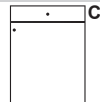
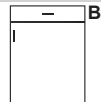
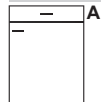


93 black glass



88 Linea glass

**Available handle arrangements**



**Grip ledges**




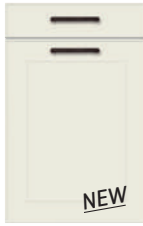
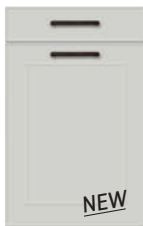








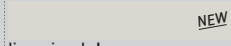




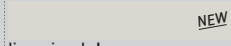




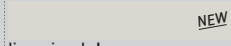
N 400, N 475,  
N 485,  
N 900 N 975,  
N 700, N 775

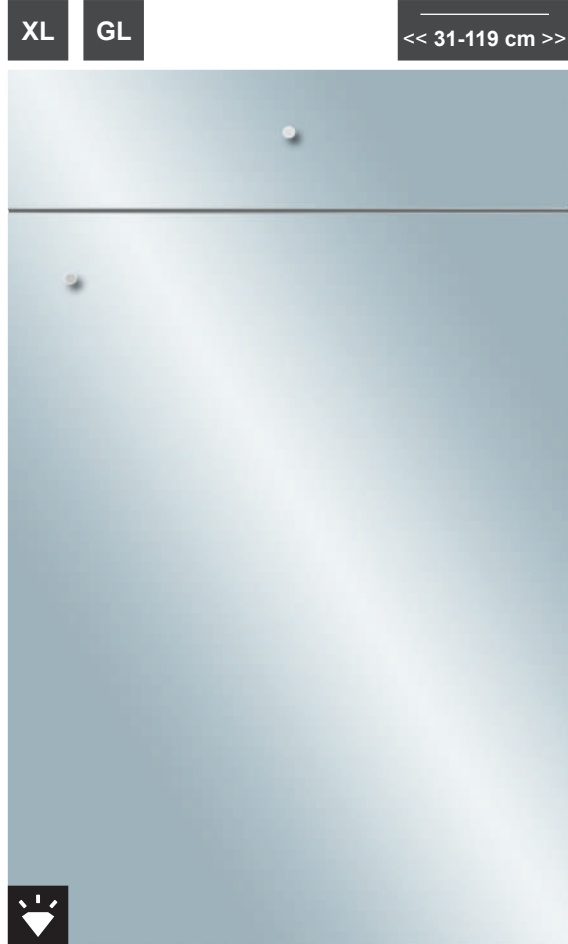
**Handles**



M330  
M340  
G320  
G321  
G370  
G371  
G024

**cornices / light pelmets**

<p><b>Front decor</b> snow white <b>Surface</b> Velvet lacquer</p>  <p><b>XL 68146</b></p> <p><b>Reference carcass</b> K160F Snow white</p> <p><b>Visible sides</b> B160F Snow White</p>	<p><b>Front decor</b> premium white <b>Surface</b> Velvet lacquer</p>  <p><b>XL 68150</b></p> <p><b>Reference carcass</b> K039P Premium white</p> <p><b>Visible sides</b> B039F Premium white</p>	<p><b>Front decor</b> White Agate <b>Surface</b> Velvet lacquer</p>  <p><b>XL 68156</b></p> <p><b>Reference carcass</b> K178F White Agate</p> <p><b>Visible sides</b> B178F White Agate</p>								
<p><b>Front decor</b> Night Green <b>Surface</b> Velvet lacquer</p>  <p><b>XL 68159</b></p> <p><b>Reference carcass</b> K075P Black</p> <p><b>Visible sides</b> B245F Night Green</p>	<p><b>Front decor</b> light grey <b>Surface</b> Velvet lacquer</p>  <p><b>XL 68160</b></p> <p><b>Reference carcass</b> K006P Light Grey</p> <p><b>Visible sides</b> B006F Light Grey</p>	<p><b>Front decor</b> Macaron <b>Surface</b> Velvet lacquer</p>  <p><b>XL 68165</b></p> <p><b>Reference carcass</b> K076P Macaron</p> <p><b>Visible sides</b> B076F Macaron</p>								
<p><b>Front decor</b> Light Nude <b>Surface</b> Velvet lacquer</p>  <p><b>XL 68166</b></p> <p><b>Reference carcass</b> K248P Light Nude</p> <p><b>Visible sides</b> S248P Light Nude</p>	<p><b>Front decor</b> Fango <b>Surface</b> Velvet lacquer</p>  <p><b>XL 68167</b></p> <p><b>Reference carcass</b> K263P Fango</p> <p><b>Visible sides</b> B263F Fango</p>	<p><b>Front decor</b> Light Pepper <b>Surface</b> Velvet lacquer</p>  <p><b>XL 68169</b></p> <p><b>Reference carcass</b> K218P Light Pepper</p> <p><b>Visible sides</b> B218F Light Pepper</p>								
<p><b>Front decor</b> magic grey <b>Surface</b> Velvet lacquer</p>  <p><b>XL 68184</b></p> <p><b>Reference carcass</b> K058P Magic-grey</p> <p><b>Visible sides</b> B058F Magic-grey</p>	<p><b>Front decor</b> graphite black <b>Surface</b> Velvet lacquer</p>  <p><b>XL 68195</b></p> <p><b>Reference carcass</b> K043P Graphite Black</p> <p><b>Visible sides</b> B043F Graphite Black</p>	<p><b>Front decor</b> black <b>Surface</b> Velvet lacquer</p>  <p><b>XL 68198</b></p> <p><b>Reference carcass</b> K075P Black</p> <p><b>Visible sides</b> B075F Black</p>								
<p><b>Front decor</b> special colour <b>Surface</b> Velvet lacquer</p>  <p><b>XL 68199</b></p> <p><b>Reference carcass</b> K023P Stainless Steel Colour</p> <p><b>Visible sides</b> B099F special colour</p>	<p style="text-align: center;"><b>Colour concept at no extra charge</b></p> <table border="1"> <tbody> <tr> <td data-bbox="595 1751 831 1841">  Sealbrown RAL 8019                 </td> <td data-bbox="831 1751 1062 1841">  Cristal red SIKKENS C0.60.30                 </td> </tr> <tr> <td data-bbox="595 1841 831 1930">  Savona green SIKKENS K0.05.47                 </td> <td data-bbox="831 1841 1062 1930">  Victoria green RAL 180 30 10                 </td> </tr> <tr> <td data-bbox="595 1930 831 2020">  Night Red SIKKENS C0.20.20                 </td> <td data-bbox="831 1930 1062 2020">  Blackblue SIKKENS U0.10.20                 </td> </tr> <tr> <td data-bbox="595 2020 831 2096">  Jade, pastel RAL 7032                 </td> <td data-bbox="831 2020 1062 2096">  live simple! No. 8                 </td> </tr> </tbody> </table>		 Sealbrown RAL 8019	 Cristal red SIKKENS C0.60.30	 Savona green SIKKENS K0.05.47	 Victoria green RAL 180 30 10	 Night Red SIKKENS C0.20.20	 Blackblue SIKKENS U0.10.20	 Jade, pastel RAL 7032	 live simple! No. 8
 Sealbrown RAL 8019	 Cristal red SIKKENS C0.60.30									
 Savona green SIKKENS K0.05.47	 Victoria green RAL 180 30 10									
 Night Red SIKKENS C0.20.20	 Blackblue SIKKENS U0.10.20									
 Jade, pastel RAL 7032	 live simple! No. 8									



**XL 6860**

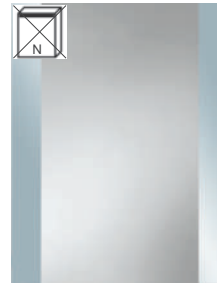
- Front decor** SMARTGLAS, mirror (rear in grey)
- Surface** Polymeric glass 2 mm smooth
- Front thickness** 19 mm
- Door shape** 15,089 kg/sqm excluding handle weight (see handles)  
straight, 4 sides with contoured PP edge
- Front material** MDF material with high-grade 2 mm polymeric glass coating and 2 mm stabilising layer

**Note:**  
Range always without tightening fitting!

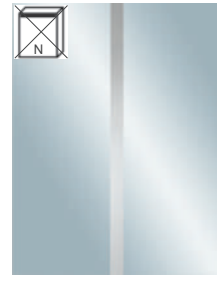
**Available glass doors for specific models**



**Segment glass door**  
e.g. HG 50 78 34 SE



**Semi-frameless glass door...**  
e.g. HG 50 78 34 LS



**Semi-frameless glass door / glass width 5 cm...**  
e.g. HG 50 78 34 LB

**Reference carcass**

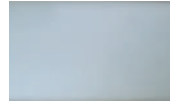
**K043P**  
Graphite Black

**Visible sides**

**Available glass versions**



90 clear glass



92 matt glass

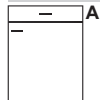


93 black glass



88 Linea glass

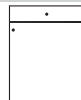
**Available handle arrangements**



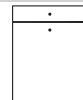
**A**



**B**



**C\***



**D**



**M**

\* = Standard finish

**Grip ledges**

**Handles**

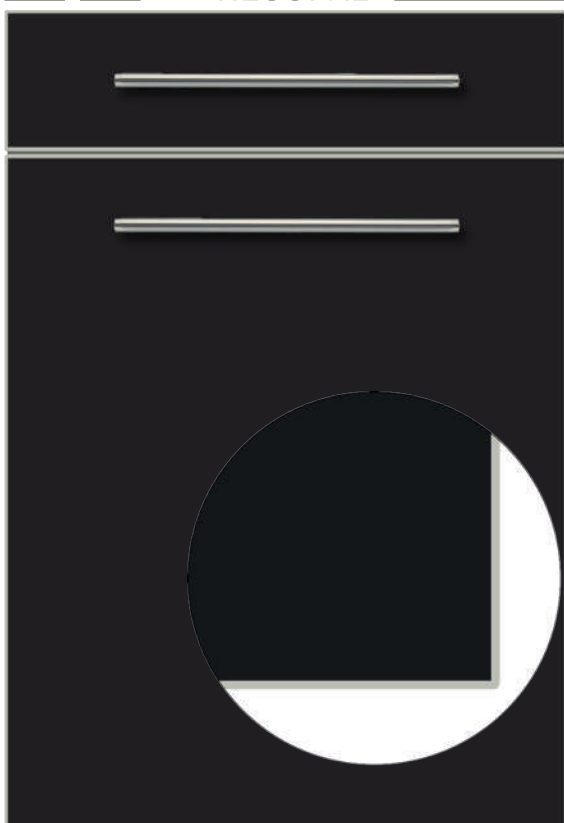
**cornices / light pelmets**



N 400, N 475,  
N 485,  
N 900 N 975,



**XL GL ORIGINAL RESOPAL®** << 31-119 cm >>



**XL 7900**

- Front decor** black super matt (rear texture in same colour)
- Surface** Smooth
- Front thickness** 22 mm
- Door shape** 15.50 kg/sqm excluding handle weight (see handles) straight, 4 sided with real aluminium edge 2.5 mm
- Front material** Multi-layer particle board, both sides with laminate "RESOPAL" 0.8 mm

**Note:**  
The ALU TEC RP is a handcrafted, real aluminum frame front, which may have tolerances due to the material.

- Limited range of types:**
- Corner cabinets only available with fixed corner brackets
  - Equipment cabinets with equalization panel not available.
  - Minimum dimensions for 44 mm panels
  - Minimum dimensions for corner brackets 6 x 6 cm
  - Corner wall cabinets HE... not available
  - Substructure for raised dishwashers with slanted front part not available
  - Adapters 135° not available
  - Diagonal cupboards not available
  - Pocket door and swing door (pivot) not available

**Reference carcass**

**K075P**  
Black

**Visible sides**

**I075M**  
Black super matt

**Available handle arrangements**

\* = Standard finish

Grip ledges	Handles	cornices / light pelmets
N 400, N 475, N 485, N 900 N 975, N 700, N 775	G320, G321, G370, G371, M330, M340	

**Front decor** Premium white super matt

**Surface** Smooth

**XL 7905**

**Reference carcass**  
K039P  
Premium white

**Visible sides**  
I039M  
Premium white super matt

**Front decor** Dark Powder super matt

**Surface** Smooth

**XL 7910**

**Reference carcass**  
K075P  
Black

**Visible sides**  
I241M  
Dark Powder super matt



XL GL

<< 31-119 cm >>

**XL 7811**

- Front decor** Moderno Rustico oak stained (rear in same colour)
- Surface** Veneer sealed with high-quality lacquer
- Front thickness** 21.5 mm
- Door shape** 13,11 kg/sqm excluding handle weight (see handles) framed front, all round with 1.5 mm thick edge, frame width 10 mm
- Front material** Multi-layer particle board, oak veneer on both sides, rear smooth

**NEW**

**Note:**  
Range always without tightening fitting!

**Available glass doors for specific models**



Framed glass door...  
e.g. HG 50 78 34 RA

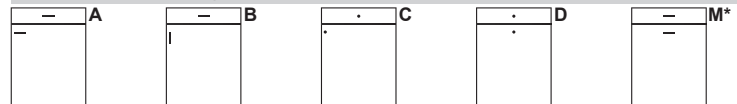
**Reference carcass**  
K230P  
Art Pepper

**Visible sides**  
Z279K  
Moderno Rustico, stained

**Available glass versions**

90 clear glass	92 matt glass	93 black glass	88 Linea glass

**Available handle arrangements**



\* = Standard finish

<b>Grip ledges</b>	<b>Handles</b>	<b>cornices / light pelmets</b>
N 400, N 475, N 485, N 900 N 975, N 700, N 775	M330, M340, G320, G321, G370, G371, G024	

**Front decor** Special colour oak veneer

**Surface** Veneer sealed with high-quality lacquer

**XL 7829**

**Reference carcass**  
K023P  
Stainless Steel Colour

**Visible sides**  
F099K  
special colour lacquered

**Colour concept at no extra charge**

Sealbrown RAL 8019	Cristal red SIKKENS C0.60.30
Savona green SIKKENS K0.05.47	Victoria green RAL 180 30 10
Night Red SIKKENS C0.20.20	Blackblue SIKKENS U0.10.20
Jade, pastel RAL 7032	live simple! No. 8

**Front decor** Premium white lacquered oak  
**Surface** Veneer sealed with high-quality lacquer




**XL 7810**

Range always without tightening fitting!

**Reference carcass**  
K230P  
Art Pepper

**Visible sides**  
F039S  
premium white lacquer

**Front decor** Urban Oak Stained  
**Surface** Veneer sealed with high-quality lacquer

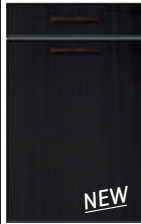


**XL 7814**

**Reference carcass**  
K230P  
Art Pepper

**Visible sides**  
F261K  
Urban Oak stained

**Front decor** black lacquered oak  
**Surface** Veneer sealed with high-quality lacquer




**XL 7815**

**Reference carcass**  
K075P  
Black

**Visible sides**  
F075S  
black lacquer

**Front decor** Eiche Light Nude lacquered  
**Surface** Veneer sealed with high-quality lacquer

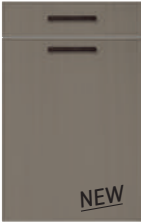


**XL 7816**

**Reference carcass**  
K248P  
Light Nude

**Visible sides**  
F248S  
Light Nude lacquered

**Front decor** Fango oak, lacquered  
**Surface** Veneer sealed with high-quality lacquer

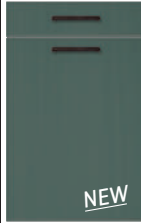


**XL 7817**

**Reference carcass**  
K263P  
Fango

**Visible sides**  
F263S  
Fango, lacquered

**Front decor** Oak Night Green lacquered  
**Surface** Veneer sealed with high-quality lacquer




**XL 7819**

**Reference carcass**  
K075P  
Black

**Visible sides**  
F245S  
Night Green lacquered

**Front decor** oak Art Pepper lacquered  
**Surface** Veneer sealed with high-quality lacquer




**XL 7820**

**Reference carcass**  
K230P  
Art Pepper

**Visible sides**  
F230S  
Art Pepper lacquered

**Front decor** Macaron oak lacquered  
**Surface** Veneer sealed with high-quality lacquer




**XL 7821**

**Reference carcass**  
K076P  
Macaron

**Visible sides**  
F076K  
Macaron lacquered

**Front decor** oak Light Pepper lacquered  
**Surface** Veneer sealed with high-quality lacquer




**XL 7822**

**Reference carcass**  
K218P  
Light Pepper

**Visible sides**  
F218S  
Light Pepper lacquered

**Front decor** oak stained silky grey  
**Surface** Veneer sealed with high-quality lacquer




**XL 7823**

**Reference carcass**  
K043P  
Graphite Black

**Visible sides**  
F058K  
Sily grey, stained

**Front decor** untreated oak, stained  
**Surface** Veneer sealed with high-quality lacquer

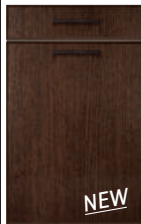


**XL 7824**

**Reference carcass**  
K230P  
Art Pepper

**Visible sides**  
F213K  
untreated stained

**Front decor** coffee brown oak stained  
**Surface** Veneer sealed with high-quality lacquer




**XL 7825**

**Reference carcass**  
K075P  
Black

**Visible sides**  
F214K  
coffee brown stained

**Front decor** graphite black oak lacquered  
**Surface** Veneer sealed with high-quality lacquer

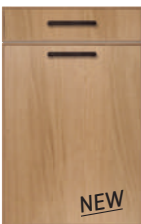


**XL 7826**

**Reference carcass**  
K043P  
Graphite Black

**Visible sides**  
F043S  
Graphite Black Lacquered

**Front decor** Gavi oak veneer  
**Surface** Veneer sealed with high-quality lacquer

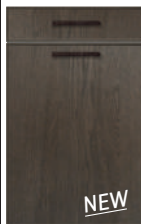


**XL 7830**

**Reference carcass**  
K230P  
Art Pepper

**Visible sides**  
F258K  
Gavi oak veneer

**Front decor** Dark oak stained  
**Surface** Veneer sealed with high-quality lacquer



**XL 7831**

**Reference carcass**  
K043P  
Graphite Black

**Visible sides**  
F259K  
Dark oak stained

**XL** **GL** << 31-119 cm >>



**XL 7701**

- Front decor** mature oak wood veneer vertical (rear in same colour)
- Surface** Veneer sealed with high-quality lacquer
- Front thickness** 19 mm
- Door shape** 12,757 kg/sqm excluding handle weight (see handles) straight, 4 sides with thick oak veneer edge 1.5 mm
- Front material** Multi-layer particle board, front side mature oak veneer, rear oak veneer

**Quality description:**  
 Boards are the **ONLY** option available in regard to the visual appearance. Such attributes as matching veneer, frieze or quilted figures are not possible. Continuous or identical batches likewise cannot be realized for individual or multiple deliveries. Basically, every single mature wood front is unique; the common denominator of the product is the rustic look that reflects the spirit of the times. Typical wood properties

- Cracks parallel and at right angles to the fibre
- Knots in various forms, including loose knots
- differences in colour, including striking differences (even within the individual panels)
- worm holes
- Mechanical damage (signs of use), such as blows. These properties are characteristic of mature wood and do not constitute grounds for complaint.

**Available glass doors for specific models**



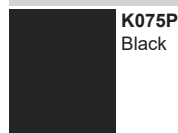
**Semi-frameless glass door...**  
 e.g. HG 50 78 34 LS



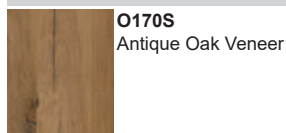
**Semi-frameless glass door / glass width 5 cm...**  
 e.g. HG 50 78 34 LB



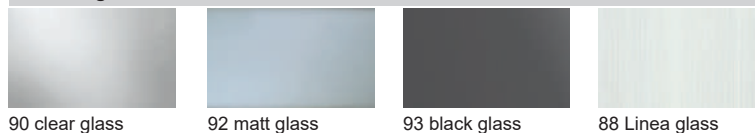
**Reference carcass**



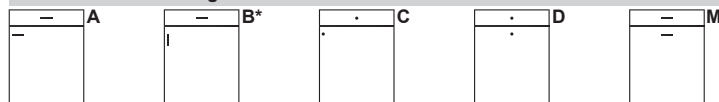
**Visible sides**



**Available glass versions**



**Available handle arrangements**



\* = Standard finish

**Grip ledges**



**Handles**



**cornices / light pelmets**

**Front decor** larch veneer vertical

**Surface** Veneer sealed with high-quality lacquer



**XL 7750**

**Reference carcass**  
K075P  
Black

**Visible sides**

O215S  
larch veneer

**Front decor** Spessart oak light

**Surface** Veneer sealed with high-quality lacquer



**XL 7710**

**Reference carcass**  
K075P  
Black

**Visible sides**

O197S  
Light Spessart oak

**Front decor** Spessart oak leached veneer vertical

**Surface** Veneer sealed with high-quality lacquer



**XL 7770**

**Reference carcass**  
K230P  
Art Pepper

**Visible sides**

O232S  
Spessart-oak leached

**Front decor** Spessart oak Honey veneer vertical

**Surface** Veneer sealed with high-quality lacquer



**XL 7780**

**Reference carcass**  
K230P  
Art Pepper

**Visible sides**

O233S  
Spessart-oak Honey





**XL 7700**

**Front decor** mature oak veneer horizontal  
(rear in same colour)  
**Surface** Veneer sealed with high-quality lacquer  
**Front thickness** 19 mm  
 12,757 kg/sqm excluding handle weight (see handles)  
**Door shape** straight, 4 sides with thick oak veneer edge 1.5 mm

**Front material** Multi-layer particle board, front side mature oak veneer, rear oak veneer

**Quality description:**

Boards are the **ONLY** option available in regard to the visual appearance. Such attributes as matching veneer, frieze or quilted figures are not possible. Continuous or identical batches likewise cannot be realized for individual or multiple deliveries. Basically, every single mature wood front is unique; the common denominator of the product is the rustic look that reflects the spirit of the times.

**Typical wood properties**

- Cracks parallel and at right angles to the fibre
- Knots in various forms, including loose knots
- differences in colour, including striking differences (even within the individual panels)
- worm holes
- Mechanical damage (signs of use), such as blows. These properties are characteristic of mature wood and do not constitute grounds for complaint.

**Available glass doors for specific models**



**Semi-frameless glass door...**  
e.g. HG 50 78 34 LS



**Semi-frameless glass door / glass width 5 cm...**  
e.g. HG 50 78 34 LB

**Reference carcase**

**K075P**  
Black

**Visible sides**

**O170S**  
Antique Oak Veneer

**Available glass versions**

90 clear glass	92 matt glass	93 black glass	88 Linea glass

**Available handle arrangements**

A	B*	C	D	M

\* = Standard finish

<b>Grip ledges</b>	<b>Handles</b>	<b>cornices / light pelmets</b>
N 400, N 475, N 485, N 900 N 975,	M330 M340	

**Front decor** Spessart oak light veneer Horizontal  
**Surface** Veneer sealed with high-quality lacquer



**XL 7715**

**Reference carcass**  
**K075P**  
 Black

**Visible sides**  
**O197S**  
 Light Spessart oak

**Front decor** larch veneer horizontal  
**Surface** Veneer sealed with high-quality lacquer



**XL 7755**

**Reference carcass**  
**K075P**  
 Black

**Visible sides**  
**O215S**  
 larch veneer

**Front decor** Spessart oak leached veneer horizontal  
**Surface** Veneer sealed with high-quality lacquer



**XL 7775**

**Reference carcass**  
**K230P**  
 Art Pepper

**Visible sides**  
**O232S**  
 Spessart-oak leached

**Front decor** Spessart oak honey veneer horizontal  
**Surface** Veneer sealed with high-quality lacquer



**XL 7785**

**Reference carcass**  
**K230P**  
 Art Pepper

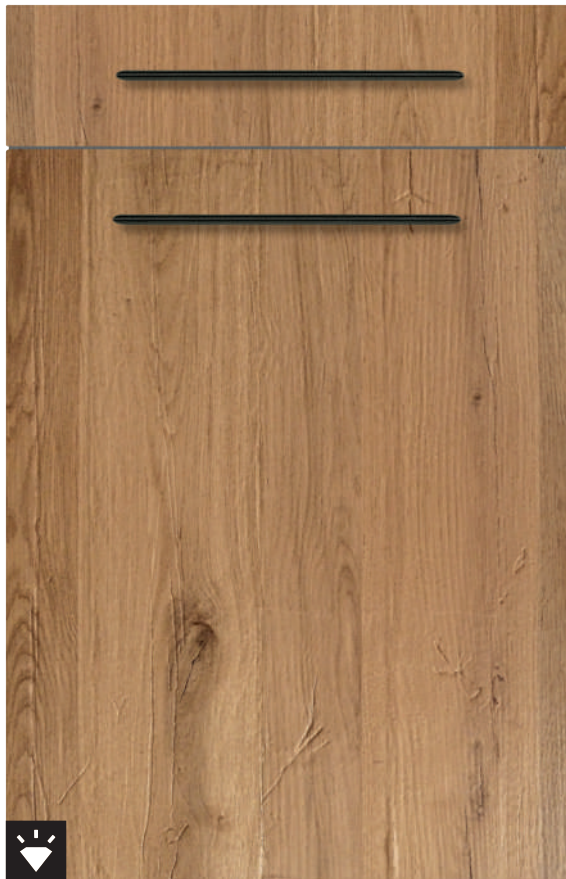
**Visible sides**  
**O233S**  
 Spessart-oak Honey



XL

GL

<< 31-119 cm >>



**XL 7500**

- Front decor** Rusty Oak  
(rear in same colour)
- Surface** Veneer sealed with high-quality lacquer
- Front thickness** 21 mm
- Door shape** 15.330 kg/sqm excluding handle weight (see handles)  
straight, four sides with edge 0.5 mm
- Front material** Multi-layer particle board, front side mature oak veneer, rear oak

**Note:**

The faces of this front are made from selected mature wood veneers. The individual veneer leaves (approx. 5–30 cm wide) are joined by hand and then pressed under high pressure onto a black base layer. The results are fronts that differ in colour, structure and character, and so enhance the uniqueness of every consignment. Knots and cracks of different shapes and sizes may appear in the finished front. These are carefully chosen features in the veneer, and are what give the consignment its individual and expressive appearance. These characteristics are typical of the material, and will not be accepted as flaws or a complaint.

**Available glass doors for specific models**

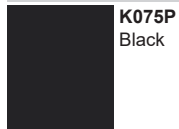


**Semi-frameless glass door...**  
e.g. HG 50 78 34 LS



**Semi-frameless glass door / glass width 5 cm...**  
e.g. HG 50 78 34 LB

**Reference carcase**



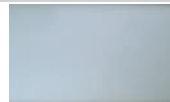
**K075P**  
Black

**Visible sides**

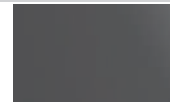
**Available glass versions**



90 clear glass



92 matt glass

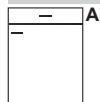


93 black glass



88 Linea glass

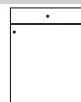
**Available handle arrangements**



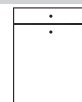
A



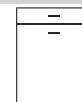
B



C



D



M\*

\* = Standard finish

**Grip ledges**



N 400, N 475,  
N 485,  
N 900 N 975,  
N 700, N 775

**Handles**



M330  
M340

**cornices / light pelmets**



**XL 7050**

- Front decor** premium white (rear in same matt colour)
- Surface** Matt lacquer
- Front thickness** 22 mm
- Door shape** Modern coffered front with inner profile, frame width 75 mm, gold-coloured trim
- Front material** MDF substrate with high-quality lacquered surface

**Note:**  
 Width 15 cm is supplied with smooth fronts  
 Width 20 cm is supplied with smooth fronts  
 Width 25 cm is supplied with smooth fronts

**Available glass doors for specific models**



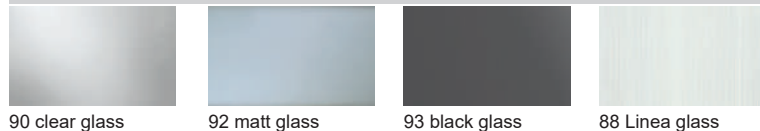
Framed glass door...  
 e.g. HG 50 78 34 RA

**Reference carcass**

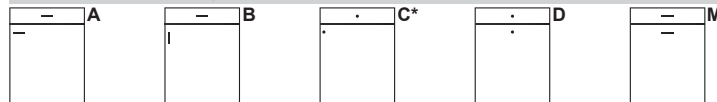
**K039P**  
 Premium white

**Visible sides**

**Available glass versions**

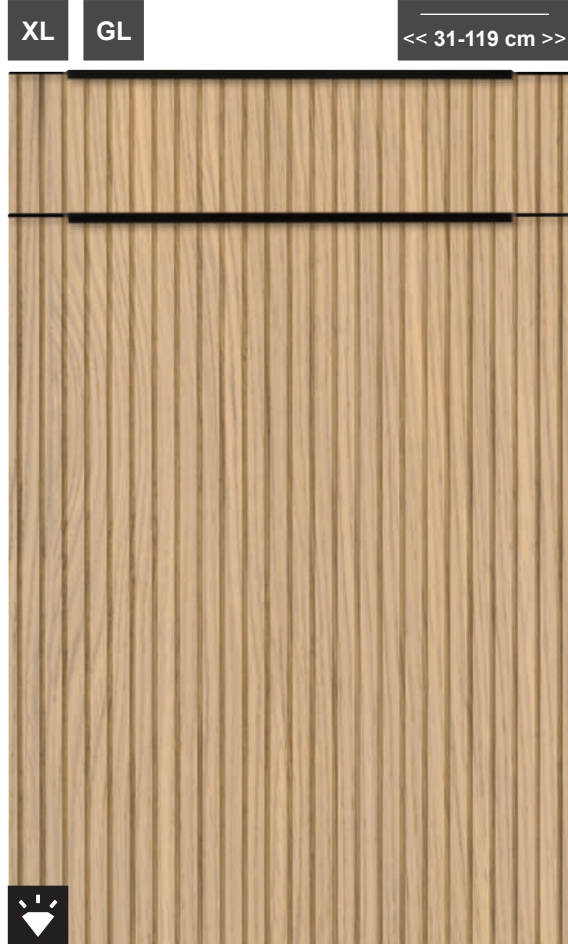


**Available handle arrangements**



\* = Standard finish

<p><b>Grip ledges</b></p> <p><del></del> N 400, N 475, N 485, N 900 N 975, N 700, N 775</p>	<p><b>Handles</b></p> <p><del></del> G 110, M330, M340</p>	<p><b>cornices / light pelmets</b></p> <p></p> <p></p> <p>KL 105      LB 101</p>
---	--	--



**XL 8060**

- Front decor** Gavi oak veneer (rear in same colour)
- Surface** Veneer sealed with high-quality lacquer
- Front thickness** 20 mm
- Door shape** 13,000 kg/sqm excluding handle weight (see handles)  
straight, 4 sides with thick oak veneer edge 0.4 mm, with vertical grooves, spacing 6.5 mm
- Front material** multi-layer particle board, oak veneer on both sides (knots possible)

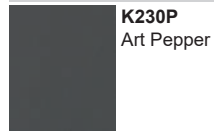
**Note:**

The grooves are arranged evenly on the right and left according to the width of the front. Range always without tightening fitting!

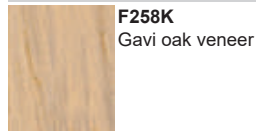
**Quality description:**

The deeply embossed thick veneer contains slight knots of varying degrees. Depending on the viewing angle, these areas can change from light to dark. Due to the manufacturing process, there may be slight ridges in the grooves of this front. A distortion of +/-1.8 mm/meter is to be accepted due to the particularly deep embossing of the 5-layer veneer

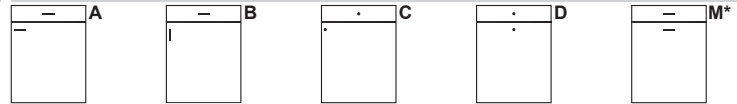
**Reference carcass**



**Visible sides**

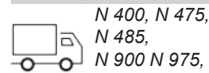


**Available handle arrangements**



\* = Standard finish

**Grip ledges**



N 400, N 475,  
N 485,  
N 900 N 975,

**Handles**



M330 M340

**cornices / light pelmets**

<p><b>Front decor</b> Rosso walnut veneer</p> <p><b>Surface</b> Veneer sealed with high-quality lacquer</p>  <p><b>XL 8065</b></p> <p><b>Reference carcass</b> K075P Black</p> <p><b>Visible sides</b> F257K Rosso walnut veneer</p>	<p><b>Front decor</b> Dark oak stained</p> <p><b>Surface</b> Veneer sealed with high-quality lacquer</p>  <p><b>XL 8070</b></p> <p><b>Reference carcass</b> K043P Graphite Black</p> <p><b>Visible sides</b> F259K Dark oak stained</p>	<p><b>Front decor</b> Premium white lacquered oak</p> <p><b>Surface</b> Veneer sealed with high-quality lacquer</p>  <p><b>XL 8120</b></p> <p><b>Reference carcass</b> K039P Premium white</p> <p><b>Visible sides</b> F039S premium white lacquer</p>
<p><b>Front decor</b> black lacquered oak</p> <p><b>Surface</b> Veneer sealed with high-quality lacquer</p>  <p><b>XL 8125</b></p> <p><b>Reference carcass</b> K075P Black</p> <p><b>Visible sides</b> F075S black lacquer</p>	<p><b>Front decor</b> Eiche Light Nude lacquered</p> <p><b>Surface</b> Veneer sealed with high-quality lacquer</p>  <p><b>XL 8126</b></p> <p><b>Reference carcass</b> K248P Light Nude</p> <p><b>Visible sides</b> F248S Light Nude lacquered</p>	<p><b>Front decor</b> Oak Night Green lacquered</p> <p><b>Surface</b> Veneer sealed with high-quality lacquer</p>  <p><b>XL 8129</b></p> <p><b>Reference carcass</b> K075P Black</p> <p><b>Visible sides</b> F245S Night Green lacquered</p>
<p><b>Front decor</b> oak Art Pepper lacquered</p> <p><b>Surface</b> Veneer sealed with high-quality lacquer</p>  <p><b>XL 8140</b></p> <p><b>Reference carcass</b> K230P Art Pepper</p> <p><b>Visible sides</b> F230S Art Pepper lacquered</p>	<p><b>Front decor</b> Macaron oak lacquered</p> <p><b>Surface</b> Veneer sealed with high-quality lacquer</p>  <p><b>XL 8165</b></p> <p><b>Reference carcass</b> K076P Macaron</p> <p><b>Visible sides</b> F076K Macaron lacquered</p>	<p><b>Front decor</b> Fango oak, lacquered</p> <p><b>Surface</b> Veneer sealed with high-quality lacquer</p>  <p><b>XL 8167</b></p> <p><b>Reference carcass</b> K263P Fango</p> <p><b>Visible sides</b> F263S Fango, lacquered</p>
<p><b>Front decor</b> oak Light Pepper lacquered</p> <p><b>Surface</b> Veneer sealed with high-quality lacquer</p>  <p><b>XL 8169</b></p> <p><b>Reference carcass</b> K218P Light Pepper</p> <p><b>Visible sides</b> F218S Light Pepper lacquered</p>	<p><b>Front decor</b> graphite black oak lacquered</p> <p><b>Surface</b> Veneer sealed with high-quality lacquer</p>  <p><b>XL 8195</b></p> <p><b>Reference carcass</b> K043P Graphite Black</p> <p><b>Visible sides</b> F043S Graphite Black Lacquered</p>	<p><b>Front decor</b> Special colour oak veneer</p> <p><b>Surface</b> Veneer sealed with high-quality lacquer</p>  <p><b>XL 8149</b></p> <p><b>Reference carcass</b> K230P Art Pepper</p> <p><b>Visible sides</b> F099K special colour lacquered</p>

Colour concept at no extra charge	
 Sealbrown RAL 8019	 Cristal red SIKKENS C0.60.30
 Savona green SIKKENS K0.05.47	 Victoria green RAL 180 30 10
 Night Red SIKKENS C0.20.20	 Blackblue SIKKENS U0.10.20
 Jade, pastel RAL 7032	 live simple! No. 8

**XL** **GL**



**XL 8200**

- Front decor** Gavi oak veneer (rear in same colour)
- Surface** Veneer sealed with high-quality lacquer
- Front thickness** 20 mm
- Door shape** 14,054 kg/sqm excluding handle weight (see handles)  
straight, 4 sides with thick oak veneer edge 1.5 mm
- Front material** multi-layer particle board, oak veneer on both sides (knots possible)

**Note:**  
The grooves are arranged evenly on the right and left according to the width of the front.  
Range always without tightening fitting!

- Limited range of types:**
- No front material available.
  - End panels not available
  - Pocket door and swing door (pivot) not available



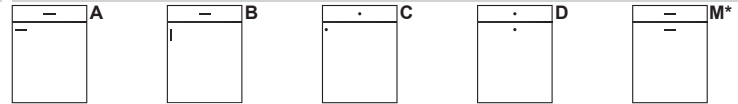
**Reference carcass**

**K230P**  
Art Pepper

**Visible sides**

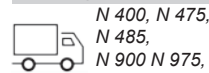
**F258K**  
Gavi oak veneer

**Available handle arrangements**



\* = Standard finish

**Grip ledges**



**Handles**



**cornices / light pelmets**

- Front decor** Rosso walnut veneer
- Surface** Veneer sealed with high-quality lacquer



**XL 8205**

**Note:** Range always without tightening fitting!

**Reference carcass**

**K075P**  
Black

**Visible sides**

**F257K**  
Rosso walnut veneer

- Front decor** Dark oak stained
- Surface** Veneer sealed with high-quality lacquer



**XL 8210**

**Reference carcass**

**K075P**  
Black

**Visible sides**

**F259K**  
Dark oak stained

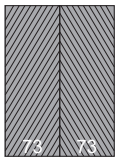
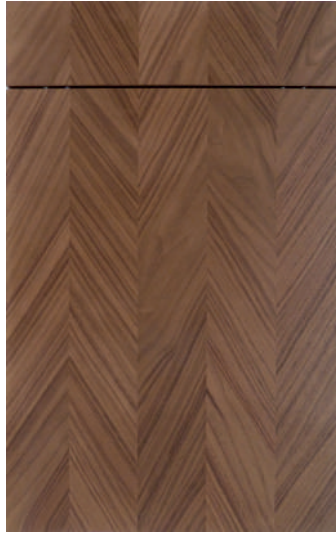
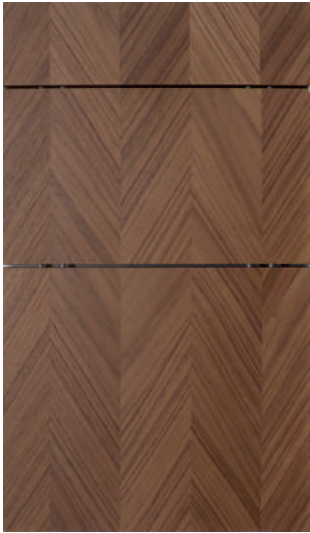


# Course INTARSIA veneer

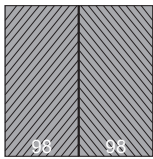
45 cm

50 cm

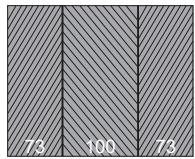
60 cm



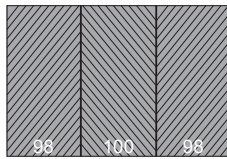
146



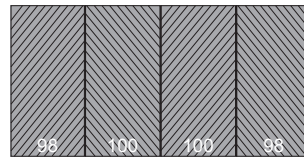
196



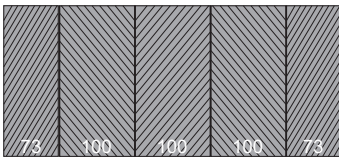
246



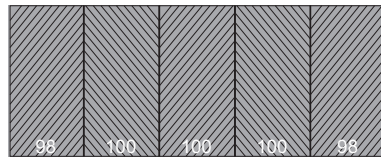
296



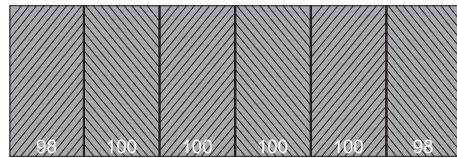
396



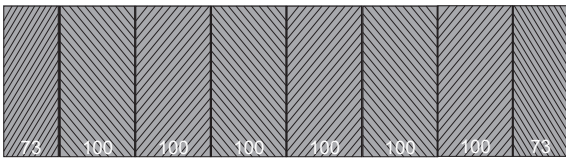
446



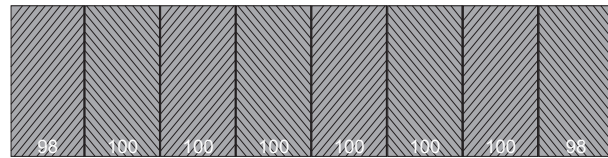
496



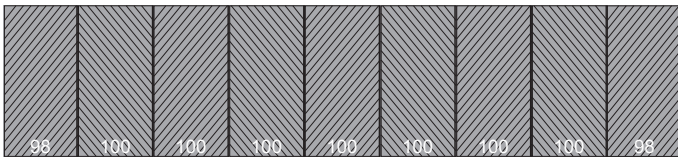
596



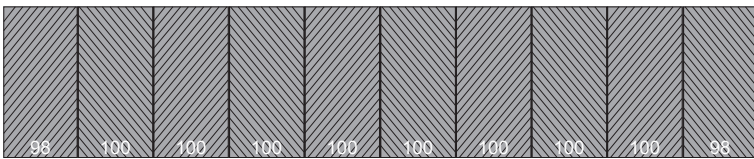
746



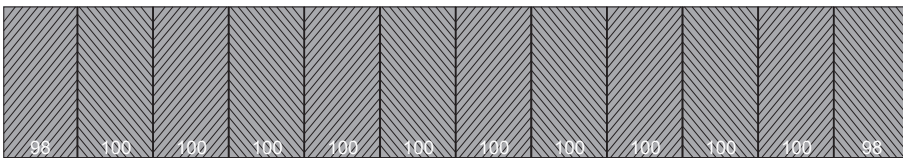
796



896



996



1196



ALU ELEMENTS



997

<b>Front decor</b>	Alu Elements
<b>Surface</b>	Aluminium brushed
<b>Front thickness</b>	5 mm
<b>Door shape</b>	straight, 4 sides with contoured PP edge, same colour
<b>Front material</b>	aluminium

**Note:**  
Selected type program see chapter 7.4.

**Limited range of types:**  
- Only available with „push to open“ fitting

Available glass doors for specific models



Framed glass door...  
e.g. HG 50 78 34 RA

Reference carcass

**K235P**  
Titan Steel

Visible sides

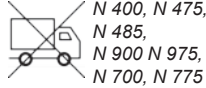
Available glass versions



90 clear glass

Available handle arrangements

Grip ledges



Handles



cornices / light pelmets

<b>Front decor</b>	Alu Elements
<b>Surface</b>	Aluminium brushed

993

**Reference carcass**  
**K235P**  
Titan Steel

Visible sides



XL



**775**

- Front decor** STRIP ELEMENTS designer front (rear texture in same colour)
- Surface** Solid ash wood black lacquer
- Front thickness** 26 mm
- Door shape** Frame door in lattice look
- Front material** Solid ash wood base material with high-quality multi-layer paint finish

**Limited range of types:**  
 - Only available with „push to open“ fitting  
 - Only available in a width of 60 cm  
 - Only available in the heights 65, 78, 84.5, 91 cm

**Reference carcass**

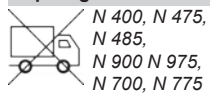


**K075P**  
Black

**Visible sides**

**Available handle arrangements**

**Grip ledges**



**Handles**



**cornices / light pelmets**

# Glass door overview/models



## Framed glass door -model-specific-

**Available for:**  
ARTE-B, ARTE-S, ATLANTA-B,  
ATLANTA-S, BERGEN, CASA-B,  
CASTELLO, CHALET-B, CHALET-  
S, CHICAGO, FRAME, LUGANO,  
LUX-B, MIAMI, NEW OPAL-M,  
NOBEL-B, NOBEL-S, OPAL-H,  
ORLANDO-B, ORLANDO-  
S, PALAZZO, PALERMO-B,  
PALERMO-S, ROMA-B, ROMA-S,  
SIGNUM-B, SOFIE-B, SOFIE-S,  
VINO, VIVA, YORK-B, YORK-S



**Note:**  
The framed glass doors are not available with the following handles:  
N 400/475/485, N 700/775, N 900/975

**Exceptions:**  
ARTE-S, ARTE-B, CASA-B, ROMA-S, ROMA-B, MIAMI  
SIGNUM-B, PALAZZO, NEW OPAL-M, OPAL-H  
are available as framed glass doors with handles N  
400/475/485 and N 900/975

HG...RA



## semi-frameless glass door -model-specific-

**Available for:**  
BAVARIA, EDITION, FENIX  
INOX, FLORENZ, GARDA, GENT,  
HPL PRO, MALMÖ, MODENA,  
MONTANA, MUNICH, NEVADA,  
OSLO 15, PADUA, PRIMEWOOD  
TOP, PUR, RESOPAL, RESOPAL  
PRO, RESOPAL PRO EDGE, VILLAGE 15-S  
RIVA, RUSTY OAK, SHERWOOD,  
SMART, SMART MIRROR,  
SMART-M, TESSIN 15, TIM, TIM  
15, TOP, TREND, VILLAGE 15-B,



**Note:**  
Available handle arrangement for semi-frameless glass door always vertical  
The semi-frameless glass doors are not available with the following handles:  
N 400/475/485, N 700/775, N 900/975

HG...LS



## semi-frameless glass door -model-specific-

**Available for:**  
BAVARIA, EDITION, FENIX INOX,  
FLORENZ, GARDA, HPL PRO,  
MALMÖ, MODENA, MONTANA,  
MUNICH, NEVADA, PADUA,  
PRIMEWOOD TOP, PUR, RESO-  
PAL, RESOPAL PRO, RESOPAL  
PRO EDGE, RIVA, RUSTY OAK,  
SHERWOOD, SMART, SMART  
MIRROR, SMART-M, TOP,  
TREND



**Note:**  
Available handle arrangement for semi-frameless glass door always vertical  
The semi-frameless glass doors are not available with the following handles:  
N 400/475/485, N 700/775, N 900/975

HG... LB



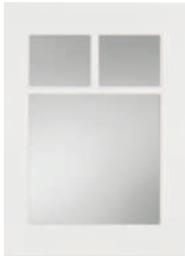
## segment glass door -model-specific-

**Available for:**  
EDITION, FENIX INOX, GARDA,  
HPL PRO, PRIMEWOOD TOP,  
PUR, RESOPAL, RESOPAL PRO,  
RESOPAL PRO EDGE, RIVA,  
SHERWOOD, SMART, SMART  
MIRROR, SMART-M, TOP,  
TREND



**Note:**  
The segment glass doors are not available with the following handles: N 700 and N 775

HG... SE



## glass door with mullions -model-specific-

**Available for:**  
ARTE-B, ARTE-S, CHALET-B,  
CHALET-S, LUX-B, NOBEL-  
B, NOBEL-S, PALERMO-B,  
PALERMO-S, ROMA-B, ROMA-S,  
SOFIE-B, SOFIE-S, YORK-B,  
YORK-S



**Note:**  
The framed glass doors are not available with the following handles:  
N 400/475/485, N 700/775, N 900/975

**Exceptions:**  
ARTE-S, ARTE-B, ROMA-S, ROMA-B  
are available as framed glass doors with handles N  
400/475/485 and N 900/975

HGS



## glass door with crossbar -model-specific-

**Available for:**  
ARTE-B, ARTE-S, CHALET-B,  
CHALET-S, LUX-B, NOBEL-  
B, NOBEL-S, PALERMO-B,  
PALERMO-S, ROMA-B, ROMA-S,  
SOFIE-B, SOFIE-S, YORK-B,  
YORK-S



**Note:**  
The framed glass doors are not available with the following handles:  
N 400/475/485, N 700/775, N 900/975

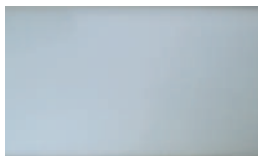
**Exceptions:**  
ARTE-S, ARTE-B, ROMA-S, ROMA-B  
are available as framed glass doors with handles N  
400/475/485 and N 900/975

HGKS...

## Glass versions available for all models at no extra charge



90 clear glass



92 matt glass



93 black glass



88 Linea glass

# Glass group G1

**Note:**

Only available without drill hole for handle  
 Door  
 Can be used with all models  
 (widths 45/50 and 60 cm).  
 Flap door  
 Can be used with all models  
 (widths 60/80/90 and 100 cm)



991 AKTIVglas

glass matt/ frame stainless steel-coloured



992 AKTIVglas

black translucent glass, night black frame

## Glass group G2 model neutral

**Note:**

Door:  
 can be used on all models  
 (widths 45/50 and 60 cm)

Pull-out/flap:  
 can be used on all models  
 (widths 45/50/60/80/90/100 and 120 cm)

Design elements from glass group G2 are not available with the following knobs/handles:  
 K 005, K 199, G 042,  
 K 064, G 110, G 242,  
 G 321, G371, G086  
 N 400/475/485, N 700/775, N 900/975



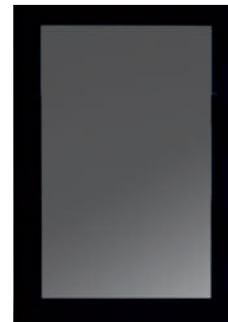
95 Design front

Frame and screen print light grey, glazing matt glass



96 Design front

Frame and screen print silver-coloured, glazing matt glass



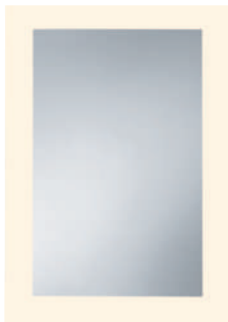
97 Design front

Frame and screen print black, Light opening, black glass



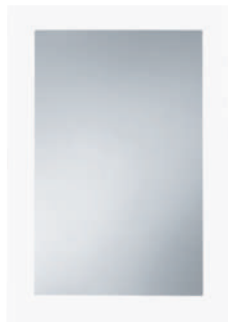
935 Design front

Frame and screen print premium white, glazing matt glass



940 Design front

Frame and screen print Macaron-coloured, glazing matt glass



960 Design front

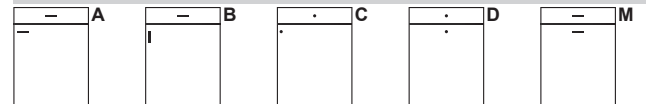
Frame and screen print snow white, glazing matt glass



925 Design front

Frame and screen print white agate, glazing matt glass

**Available handle arrangements**

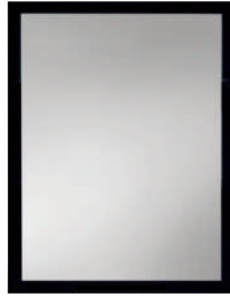


# Glass group G2S

Note:  
Door cushioning not available  
„Pust to open“ not possible  
only available as side-hung door, only with handle G033

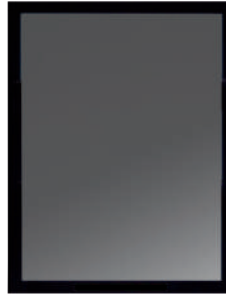
Door  
Can be used with all models  
Widths: 45 cm, 50 cm, 60 cm  
Heights: 65 cm, 78 cm, 84.5 cm, 91 cm, 143 cm, 156 cm, 169 cm, 181.8 cm, 194.8 cm, 207.8 cm, 220.8 cm

Heights: 156 cm, 169 cm, 181.8 cm, 194.8 cm, 207.8 cm, 220.8 cm are only available with vertical handles (handle arrangement B)



994 Designer front

aluminium frame with clear glass



995 Design front

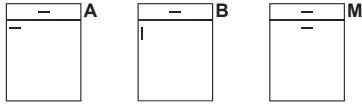
aluminium frame with black glass



988 Design front

aluminium frame with Linea glass

## Available handle arrangements

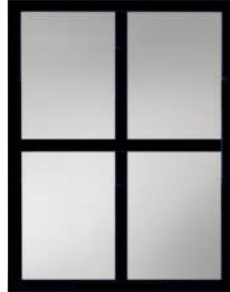


# Glass group G5S

Note:  
Door cushioning not available  
„Pust to open“ not possible  
only available as side-hung door, only with handle G033

Door can be used with all models  
Widths: 45 cm, 50 cm, 60 cm  
Heights: 65 cm, 78 cm, 84.5 cm, 91 cm, 143 cm, 156 cm, 169 cm, 181.8 cm, 194.8 cm, 207.8 cm, 220.8 cm

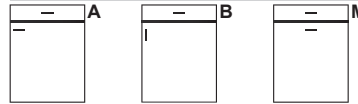
Heights: 156 cm, 169 cm, 181.8 cm, 194.8 cm, 207.8 cm, 220.8 cm are only available with vertical handles (handle arrangement B)



996 Design front

aluminium frame with clear glass and mullions

## Available handle arrangements



# Glass group G6

Note: Door cushioning not available  
„Pust to open“ not possible only available as side-hung door

1. Cannot be planned with a stop directly on a wall / side panel (a shadow bar or front adapter is always necessary)
2. Cannot be planned with stop and depth offset
3. Cannot be planned with opposite hinges for cabinets next to each other (e.g. right hinge is to the left of left hinge)

Door can be used with all models  
Widths: 45 cm, 50 cm, 60 cm  
Heights: 65 cm, 78 cm, 84.5 cm, 91 cm, 143 cm, 156 cm, 169 cm, 181.8 cm, 194.8 cm, 207.8 cm, 220.8 cm



987 New Salon aluminium black aluminium frame with clear glass



989 New Salon aluminium matt, bronze-coloured aluminium frame with black glass



990 New Salon aluminium matt, bronze-coloured aluminium frame with clear glass



986 New Salon aluminium black aluminium frame with black glass

# Groove arrangement with distance 150 mm

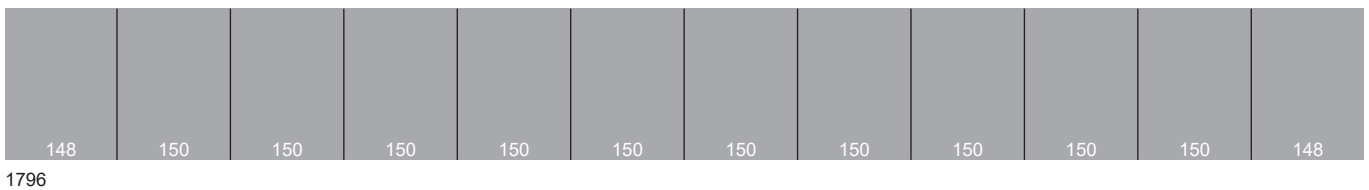
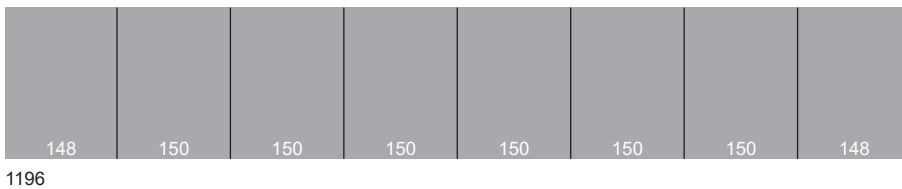
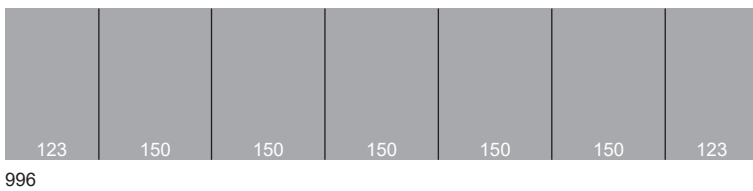
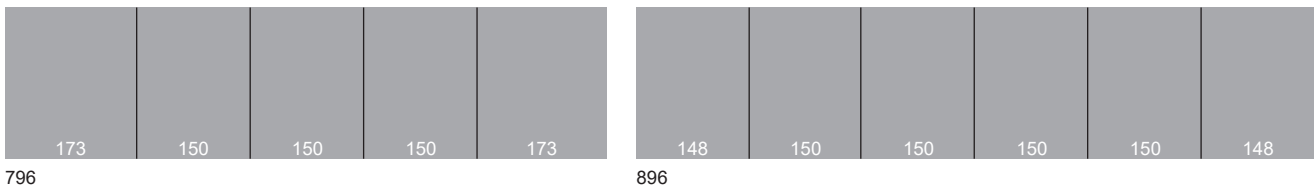
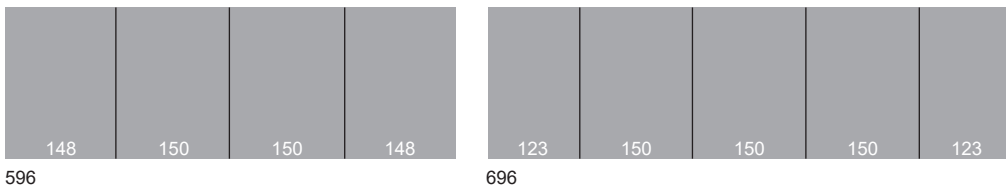
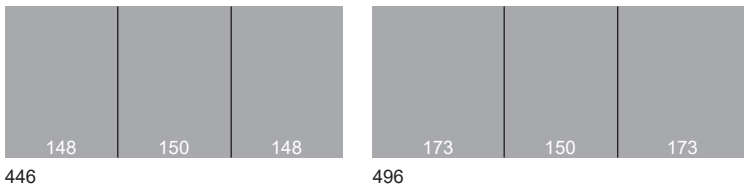
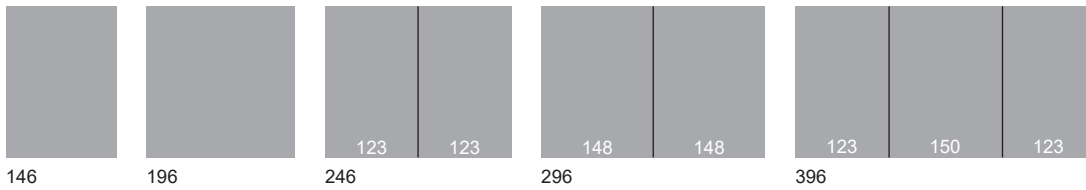
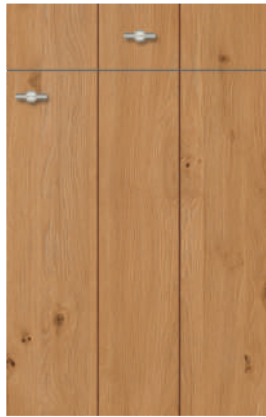
VILLAGE 15-S  
VILLAGE 15-B

OSLO 15

TESSIN 15

GENT

TIM 15





## Carcase decors / Design elements / Knobs and handles / Worktop decors

Models/surrounding elements

Carcase colours / accessory colours

Design elements

Recess back panels, printed motif

Overview - Knobs and handles

Model/handle arrangement overview

Worktop decors

Worktop decors (decor group AP16R)

Maximum dimensions





# Models/surrounding elements

Price groups	Model	Model number	front colour	Decor group / colour number	Carcasdecor	Visible sides	Plinth	background fillers	Recess back panel	Back cladding	Shelf units	Glass wall units (IDF...)	Container boxes	Panel decors 1.0 cm	Panel decors 1.6 cm	Panel decors 1.9 cm	Panel decors 2.5 cm	Panel decors 5 cm	Stiles 10 cm	pilasters	Cornice + light pelmet	Units with roller shutter	Front material

## Single-colours / coated with melamine resin

PG 1 TOP	XL 1011-1014	Premium white	K039P																				
PG 1 TOP	XL 1026-1029	Light Grey	K006P																				
PG 1 TOP	XL 1051-1054	Magic-grey	K058P																				
PG 1 TOP	XL 1056-1059	Graphite Black	K043P																				
PG 1 TOP	XL 1116-1119	Macaron	K076P																				
PG 1 TOP	XL 1181-1184	Stainless Steel Colour	K023P																				
PG 1 TOP	XL 1251-1354	Premium white glossy	K039G																				
PG 1 TOP	XL 1301-1304	Premium white matt	D039F																				
PG 1 TOP	XL 1346-1349	Snow White Gloss	K160G																				
PG 1 TOP	XL 1351-1354	Snow white matt	K160F																				
PG 1 TOP	XL 1421-1424	White Agate	K178F																				
PG 1 TOP	XL 1466-1469	Concrete effect opal	D187W																				
PG 1 TOP	XL 1471-1474	Concrete effect pearl grey	D188W																				
PG 1 TOP	XL 1486-1489	Black	K075P																				
PG 1 TOP	XL 1506-1509	graphite concrete effect	D212W																				
PG 1 TOP	XL 1586-1589	Light Pepper	K218P																				
PG 1 TOP	XL 1616-1619	Brown concrete effect	D149W																				
PG 1 TOP	XL 1621-1624	Art Pepper	K230P																				
PG 1 TOP	XL 1626-1629	Titan Steel	K235P																				
PG 1 TOP	XL 1661-1664	Light Nude	K248P																				
PG 1 TOP	XL 1721-1724	Fango	K263P																				
PG 1 TOP	XL 1761-1764	Natural sandstone effect	D271W																				
PG 1 TOP	XL 1771-1774	Jade pastel	D272F																				

## wood texture Vertical / coated with melamine resin

PG 1 TOP	XL 1211-1214	Castell Oak Effect	K005S																				
PG 1 TOP	XL 1481-1484	Mammoth oak repro. natural	K190S																				
PG 1 TOP	XL 1496-1499	Piemont Oak Repro	K199S																				
PG 1 TOP	XL 1556-1559	natural mountain oak effect	K216S																				
PG 1 TOP	XL 1606-1609	Classic Oak effect	K229S																				
PG 1 TOP	XL 1641-1644	Diamond oak effect	K236S																				
PG 1 TOP	XL 1651-1654	Dark Maron effect	K247S																				
PG 1 TOP	XL 1671-1674	Black Oak effect	D250S																				
PG 1 TOP	XL 1681-1684	Seal Oak effect	D251S																				
PG 1 TOP	XL 1691-1694	Light oak, grooved look	D264S																				
PG 1 TOP	XL 1701-1704	Dark oak, grooved look	D265S																				
PG 1 TOP	XL 1711-1714	Royal Oak effect	K262S																				
PG 1 TOP	XL 1731-1734	Mountain Wood	K269S																				
PG 1 TOP	XL 1741-1744	Elegant walnut effect	K270S																				

# Models/surrounding elements

Price groups	Model	Model number	front colour	Decor group / colour number	Carcasdecor	Visible sides	Plinth	background fillers	Recess back panel	Back cladding	Shelf units	Glass wall units (IDE...)	Container boxes	Panel decors 1.0 cm	Panel decors 1.6 cm	Panel decors 1.9 cm	Panel decors 2.5 cm	Panel decors 5 cm	Stiles 10 cm	pilasters	Cornice + light pelmet	Units with roller shutter	Front material
--------------	-------	--------------	--------------	-----------------------------	-------------	---------------	--------	--------------------	-------------------	---------------	-------------	---------------------------	-----------------	---------------------	---------------------	---------------------	---------------------	-------------------	--------------	-----------	------------------------	---------------------------	----------------

wood texture Horizontal / coated with melamine resin

PG 1	TREND	XL 1501-1504	Piemont Oak Repro	K199S																			
PG 1	TREND	XL 1521-1524	Castell Oak Effect	K005S																			
PG 1	TREND	XL 1526-1529	Mammoth oak repro. natural	K190S																			
PG 1	TREND	XL 1561-1564	natural mountain oak effect	K216S																			
PG 1	TREND	XL 1611-1614	Classic Oak effect	K229S																			
PG 1	TREND	XL 1646-1649	Diamond oak effect	K236S																			
PG 1	TREND	XL 1656-1659	Dark Maron effect	K247S																			
PG 1	TREND	XL 1676-1679	Black Oak effect	D250S	—																		
PG 1	TREND	XL 1686-1689	Seal Oak effect	D251S	—																		
PG 1	TREND	XL 1696-1699	Light oak, grooved look	D264S	—																		
PG 1	TREND	XL 1706-1709	Dark oak, grooved look	D265S	—																		
PG 1	TREND	XL 1716-1719	Royal Oak effect	K262S																			
PG 1	TREND	XL 1736-1739	Mountain Wood	K269S																			
PG 1	TREND	XL 1746-1749	Elegant walnut effect	K270S																			

DIRECTLACK matt

PG 2	PUR	XL 2621-2624	Snow White	A160M	—																		
PG 2	PUR	XL 2626-2629	Premium white	A039M	—																		
PG 2	PUR	XL 2631-2634	White Agate	A178M	—																		
PG 2	PUR	XL 2636-2639	Macaron	A076M	—																		
PG 2	PUR	XL 2641-2644	Black	A075M	—																		
PG 2	PUR	XL 2646-2649	Graphite Black	A043M	—																		
PG 2	PUR	XL 2656-2659	Light Pepper	A218M	—																		
PG 2	PUR	XL 2661-2664	Art Pepper	A230M	—																		
PG 2	PUR	XL 2676-2679	Light Nude	A248M	—																		
PG 2	PUR	XL 2681-2684	Fango	A263M	—																		

DIRECTLACK high-gloss

PG 2	EDITION	XL 2701-2704	Snow White	L160H	—																		
PG 2	EDITION	XL 2706-2709	Premium white	L039H	—																		
PG 2	EDITION	XL 2711-2714	White Agate	L178H	—																		
PG 2	EDITION	XL 2721-2724	Macaron	L076H	—																		
PG 2	EDITION	XL 2746-2749	Light Pepper	L218H	—																		
PG 2	EDITION	XL 2751-2754	Light Nude	L248H	—																		

# Models/surrounding elements

In addition to the model/colour combinations illustrated, any model can be combined with all colours.																							
Price groups	Model	Model number	front colour	Decor group / colour number	Carcasdecor	Visible sides	Plinth	background fillers	Recess back panel	Back cladding	Shelf units	Glass wall units (IDF...)	Container boxes	Panel decors 1.0 cm	Panel decors 1.6 cm	Panel decors 1.9 cm	Panel decors 2.5 cm	Panel decors 5 cm	Stiles 10 cm	plasters	Cornice + Jight pelmet	Units with roller shutter	Front material
<b>wood texture Vertical / coated with melamine resin with multiple-ply design</b>																							
PG 3	SHERWOOD	XL 3036	Sherwood Oak Repro. Black	D176S	—	—	—	—	—	—	—	—	—	—	—	—	—	—	—	—	—	—	—
PG 3	SHERWOOD	XL 3041	Sherwood Oak Repro Sepia Grey	D202S	—	—	—	—	—	—	—	—	—	—	—	—	—	—	—	—	—	—	—
<b>wood texture Vertical / Basic Veneer</b>																							
PG 3	PRIMEWOOD TOP	XL 3526	Gavi oak Basic veneer	PW258	—	—	—	—	—	—	—	—	—	—	—	—	—	—	—	—	—	—	—
PG 3	PRIMEWOOD TOP	XL 3531	Dark oak basic veneer	PW259	—	—	—	—	—	—	—	—	—	—	—	—	—	—	—	—	—	—	—
<b>wood texture Horizontal / coated with melamine resin with multiple-ply design</b>																							
PG 3	GARDA	XL 3801	Bordeaux oak effect	D224S	—	—	—	—	—	—	—	—	—	—	—	—	—	—	—	—	—	—	—
PG 3	GARDA	XL 3806	Burnt Wood	D147S	—	—	—	—	—	—	—	—	—	—	—	—	—	—	—	—	—	—	—
<b>wood texture Vertical / coated with melamine resin with multiple-ply design</b>																							
PG 3	RIVA	XL 3101	Bordeaux oak effect	D224S	—	—	—	—	—	—	—	—	—	—	—	—	—	—	—	—	—	—	—
PG 3	RIVA	XL 3111	Burnt Wood	D147S	—	—	—	—	—	—	—	—	—	—	—	—	—	—	—	—	—	—	—
<b>wood texture Vertical / coated with melamine resin with multiple-ply design</b>																							
PG 3	GENT	XL 3625	Royal Oak effect	K262S	—	—	—	—	—	—	—	—	—	—	—	—	—	—	—	—	—	—	—
PG 3	GENT	XL 3640	Diamond oak effect	K236S	—	—	—	—	—	—	—	—	—	—	—	—	—	—	—	—	—	—	—
<b>High-gloss lacquer / lacquered surface</b>																							
PG 3	MIAMI	XL 3050	Premium white	K039G	—	—	—	—	—	—	—	—	—	—	—	—	—	—	—	—	—	—	—
<b>wood texture / coated with melamine resin</b>																							
PG 3	FRAME	XL 3310	Castell Oak Effect	K005S	—	—	—	—	—	—	—	—	—	—	—	—	—	—	—	—	—	—	—
PG 3	FRAME	XL 3344	Sherwood Oak Repro. Black	D176S	—	—	—	—	—	—	—	—	—	—	—	—	—	—	—	—	—	—	—
PG 3	FRAME	XL 3345	Sherwood Oak Repro Sepia Grey	D202S	—	—	—	—	—	—	—	—	—	—	—	—	—	—	—	—	—	—	—
PG 3	FRAME	XL 3347	Bordeaux oak effect	D224S	—	—	—	—	—	—	—	—	—	—	—	—	—	—	—	—	—	—	—
PG 3	FRAME	XL 3357	Royal Oak effect	K262S	—	—	—	—	—	—	—	—	—	—	—	—	—	—	—	—	—	—	—
PG 3	FRAME	XL 3359	Classic Oak effect	K229S	—	—	—	—	—	—	—	—	—	—	—	—	—	—	—	—	—	—	—
PG 3	FRAME	XL 3361	Diamond oak effect	K236S	—	—	—	—	—	—	—	—	—	—	—	—	—	—	—	—	—	—	—
PG 3	FRAME	XL 3363	natural mountain oak effect	K216S	—	—	—	—	—	—	—	—	—	—	—	—	—	—	—	—	—	—	—
PG 3	FRAME	XL 3368	Piemont Oak Repro	K199S	—	—	—	—	—	—	—	—	—	—	—	—	—	—	—	—	—	—	—
PG 3	FRAME	XL 3369	Mammoth oak repro. natural	K190S	—	—	—	—	—	—	—	—	—	—	—	—	—	—	—	—	—	—	—
<b>Soft lacquer / lacquered surface</b>																							
PG 3	VIVA	XL 3550	Premium white	P039M	—	—	—	—	—	—	—	—	—	—	—	—	—	—	—	—	—	—	—
<b>Laminate</b>																							
PG 3	HPL PRO	XL 3001-3004	Ferro black gold	I281H	—	—	—	—	—	—	—	—	—	—	—	—	—	—	—	—	—	—	—
PG 3	HPL PRO	XL 3011-3014	Natural onyx effect	I273H	—	—	—	—	—	—	—	—	—	—	—	—	—	—	—	—	—	—	—
PG 3	HPL PRO	XL 3016-3019	Navyblue	I274H	—	—	—	—	—	—	—	—	—	—	—	—	—	—	—	—	—	—	—
PG 3	HPL PRO	XL 3191-3194	Smoke Powder	I280H	—	—	—	—	—	—	—	—	—	—	—	—	—	—	—	—	—	—	—
<b>RESOPAL / laminate</b>																							
PG 3	RESOPAL	XL 3211-3214	Premium white	K039G	—	—	—	—	—	—	—	—	—	—	—	—	—	—	—	—	—	—	—

# Models/surrounding elements

Price groups	Model	Model number	front colour	Decor group / colour number	Carcasdecor	Visible sides	Plinth	background fillers	Recess back panel	Back cladding	Shelf units	Glass wall units (IDE...)	Container boxes	Panel decors 1.0 cm	Panel decors 1.6 cm	Panel decors 1.9 cm	Panel decors 2.5 cm	Panel decors 5 cm	Stiles 10 cm	pilasters	Cornice + light pelmet	Units with roller shutter	Front material
--------------	-------	--------------	--------------	-----------------------------	-------------	---------------	--------	--------------------	-------------------	---------------	-------------	---------------------------	-----------------	---------------------	---------------------	---------------------	---------------------	-------------------	--------------	-----------	------------------------	---------------------------	----------------

## RESOPAL / laminate

PG 3	RESOPAL PRO	XL 31001-31004	Jura Grey super matt	I139M	—																		
PG 3	RESOPAL PRO	XL 31006-31009	Black super matt	I075M	—																		
PG 3	RESOPAL PRO	XL 31011-31014	Anthracite super matt	I140M	—																		
PG 3	RESOPAL PRO	XL 31016-31019	Titanium grey super matt	I138M	—																		
PG 3	RESOPAL PRO	XL 31021-31024	cool white super matt	I141M	—																		
PG 3	RESOPAL PRO	XL 31026-31029	Premium white super matt	I039M	—																		
PG 3	RESOPAL PRO	XL 31031-31034	Light Powder super matt	I240M	—																		
PG 3	RESOPAL PRO	XL 31036-31039	Dark Powder super matt	I241M	—																		
PG 3	RESOPAL PRO	XL 32001-32004	Moonlight Green super matt	I253M	—																		
PG 3	RESOPAL PRO	XL 32011-32014	Macaron powder	I076M	—																		
PG 3	RESOPAL PRO	XL 32016-32019	Brown Powder super matt	I267M	—																		
PG 3	RESOPAL PRO	XL 32021-32024	Nature Powder super matt	I268M	—																		

Also applies to the following models: RESOPAL PRO EDGE

## SMARTGLAS / high-gloss

PG 4	SMART	XL 4011	Carrara white	Q200H	—																		
PG 4	SMART	XL 4016	Cream	Q201H	—																		
PG 4	SMART	XL 4021	Sand grey	Q191H	—																		
PG 4	SMART	XL 4031	Snow White	Q160H	—																		
PG 4	SMART	XL 4036	Black	Q075H	—																		
PG 4	SMART	XL 4041	White Agate	Q178H	—																		

## SMARTGLAS / satin finish

PG 4	SMART-M	XL 4601	Carrara white	Q200M	—																		
PG 4	SMART-M	XL 4606	Cream	Q201M	—																		
PG 4	SMART-M	XL 4611	Sand grey	Q191M	—																		
PG 4	SMART-M	XL 4616	Taupe	Q192M	—																		
PG 4	SMART-M	XL 4621	Snow White	Q160M	—																		
PG 4	SMART-M	XL 4626	Black	Q075M	—																		
PG 4	SMART-M	XL 4631	White Agate	Q178M	—																		
PG 4	SMART-M	XL 4641	Carbon metallic	Q234M	—																		
PG 4	SMART-M	XL 4666	Aqua	Q244M	—																		
PG 4	SMART-M	XL 4671	Black metallic	Q254M	—																		
PG 4	SMART-M	XL 4676	Champagne metallic	Q255M	—																		
PG 4	SMART-M	XL 4681	Grey metallic	Q256M	—																		
PG 4	SMART-M	XL 4686	Silk Metallic	Q277M	—																		
PG 4	SMART-M	XL 4691	Bronze Metallic	Q278M	—																		

# Models/surrounding elements

Price groups	Model	Model number	front colour	In addition to the model/colour combinations illustrated, any model can be combined with all colours.	Decor group / colour number	Carcasdecor	Visible sides	Plinth	background fillers	Recess back panel	Back cladding	Shelf units	Glass wall units (IDF...)	Container boxes	Panel decors 1.0 cm	Panel decors 1.6 cm	Panel decors 1.9 cm	Panel decors 2.5 cm	Panel decors 5 cm	Stiles 10 cm	pilasters	Cornice + light pelmet	Units with roller shutter	Front material
--------------	-------	--------------	--------------	---	-----------------------------	-------------	---------------	--------	--------------------	-------------------	---------------	-------------	---------------------------	-----------------	---------------------	---------------------	---------------------	---------------------	-------------------	--------------	-----------	------------------------	---------------------------	----------------

## Velvet lacquer textured metallic / lacquered surface

PG 4	PALAZZO	XL 4370	Bronze Metallic	V195W	—	—	—	—	—	—	—	—	—	—	—	—	—	—	—	—	—	—	—	—
PG 4	PALAZZO	XL 4372	Basalt Metallic	V246W	—	—	—	—	—	—	—	—	—	—	—	—	—	—	—	—	—	—	—	—
PG 4	PALAZZO	XL 4374	Silver Metallic	V182W	—	—	—	—	—	—	—	—	—	—	—	—	—	—	—	—	—	—	—	—
PG 4	PALAZZO	XL 4376	Gold Metallic	V183W	—	—	—	—	—	—	—	—	—	—	—	—	—	—	—	—	—	—	—	—
PG 4	PALAZZO	XL 4378	Copper Metallic	V194W	—	—	—	—	—	—	—	—	—	—	—	—	—	—	—	—	—	—	—	—
PG 4	PALAZZO	XL 4380	Titan Metallic	V235W	—	—	—	—	—	—	—	—	—	—	—	—	—	—	—	—	—	—	—	—

## FENIX / super matt

PG 5	FENIX INOX	XL 5011	stainless steel look super matt	C023M	—	—	—	—	—	—	—	—	—	—	—	—	—	—	—	—	—	—	—	—
------	------------	---------	---------------------------------	-------	---	---	---	---	---	---	---	---	---	---	---	---	---	---	---	---	---	---	---	---

## SMARTGLAS / mirror effect

PG 6	SMART MIRROR	XL 6860			—	—	—	—	—	—	—	—	—	—	—	—	—	—	—	—	—	—	—	—
------	--------------	---------	--	--	---	---	---	---	---	---	---	---	---	---	---	---	---	---	---	---	---	---	---	---

## Soft lacquer / lacquered surface

PG 6	VINO	XL 61046	Snow White		—	—	—	—	—	—	—	—	—	—	—	—	—	—	—	—	—	—	—	—
PG 6	VINO	XL 61050	Premium white	P039M	—	—	—	—	—	—	—	—	—	—	—	—	—	—	—	—	—	—	—	—
PG 6	VINO	XL 61056	White Agate		—	—	—	—	—	—	—	—	—	—	—	—	—	—	—	—	—	—	—	—
PG 6	VINO	XL 61059	Night Green		—	—	—	—	—	—	—	—	—	—	—	—	—	—	—	—	—	—	—	—
PG 6	VINO	XL 61060	Light Grey		—	—	—	—	—	—	—	—	—	—	—	—	—	—	—	—	—	—	—	—
PG 6	VINO	XL 61062	Art Pepper		—	—	—	—	—	—	—	—	—	—	—	—	—	—	—	—	—	—	—	—
PG 6	VINO	XL 61065	Macaron		—	—	—	—	—	—	—	—	—	—	—	—	—	—	—	—	—	—	—	—
PG 6	VINO	XL 61066	Light Nude		—	—	—	—	—	—	—	—	—	—	—	—	—	—	—	—	—	—	—	—
PG 6	VINO	XL 61067	Fango		—	—	—	—	—	—	—	—	—	—	—	—	—	—	—	—	—	—	—	—
PG 6	VINO	XL 61069	Light Pepper		—	—	—	—	—	—	—	—	—	—	—	—	—	—	—	—	—	—	—	—
PG 6	VINO	XL 61084	Magic-grey		—	—	—	—	—	—	—	—	—	—	—	—	—	—	—	—	—	—	—	—
PG 6	VINO	XL 61095	Graphite Black		—	—	—	—	—	—	—	—	—	—	—	—	—	—	—	—	—	—	—	—
PG 6	VINO	XL 61098	Black		—	—	—	—	—	—	—	—	—	—	—	—	—	—	—	—	—	—	—	—
PG 6	VINO	XL 61099	special colour		—	—	—	—	—	—	—	—	—	—	—	—	—	—	—	—	—	—	—	—





# Models/surrounding elements

Price groups	In addition to the model/colour combinations illustrated, any model can be combined with all colours.			Decor group / colour number	Carcasdecor	Visible sides	Plinth	background fillers	Recess back panel	Back cladding	Shelf units	Glass wall units (IDF...)	Container boxes	Panel decors 1.0 cm	Panel decors 1.6 cm	Panel decors 1.9 cm	Panel decors 2.5 cm	Panel decors 5 cm	Stiles 10 cm	pilasters	Cornice + light pelmet	Units with roller shutter	Front material
	Model	Model number	front colour																				

## wood texture grooved/embossed / Veneer

PG 8 TALEA	XL 8060	Gavi oak veneer	F258K	—		—		—		—		—		—		—		—		—		—	
PG 8 TALEA	XL 8065	Rosso walnut veneer	F257K	—		—		—		—		—		—		—		—		—		—	
PG 8 TALEA	XL 8070	Dark oak stained	F259K	—		—		—		—		—		—		—		—		—		—	
PG 8 TALEA	XL 8120	premium white lacquer	F039S	—		—		—		—		—		—		—		—		—		—	
PG 8 TALEA	XL 8125	Black	F075S	—		—		—		—		—		—		—		—		—		—	
PG 8 TALEA	XL 8126	Light Nude	F248S	—		—		—		—		—		—		—		—		—		—	
PG 8 TALEA	XL 8129	Night Green	F245S	—		—		—		—		—		—		—		—		—		—	
PG 8 TALEA	XL 8140	Art Pepper	F230S	—		—		—		—		—		—		—		—		—		—	
PG 8 TALEA	XL 8165	Macaron	F076K	—		—		—		—		—		—		—		—		—		—	
PG 8 TALEA	XL 8167	Fango	F263S	—		—		—		—		—		—		—		—		—		—	
PG 8 TALEA	XL 8169	Light Pepper	F218S	—		—		—		—		—		—		—		—		—		—	
PG 8 TALEA	XL 8195	Graphite Black	F043S	—		—		—		—		—		—		—		—		—		—	
PG 8 TALEA	XL 8149	Special colours	F099K	—		—		—		—		—		—		—		—		—		—	

## INTARSIA / Herringbone veneer

PG 8 INTARSIA	XL 8200	Gavi oak veneer	F258K	—		—		—		—		—		—		—		—		—		—	
PG 8 INTARSIA	XL 8205	Rosso walnut veneer	F257K	—		—		—		—		—		—		—		—		—		—	
PG 8 INTARSIA	XL 8210	Dark oak stained	F259K	—		—		—		—		—		—		—		—		—		—	

# Models/surrounding elements

Price groups	In addition to the model/colour combinations illustrated, any model can be combined with all colours.			Decor group / colour number	Carcasdecor	Visible sides	Plinth	background fillers	Recess back panel	Back cladding	Shelf units	Glass wall units (IDE...)	Container boxes	Panel decors 1.0 cm	Panel decors 1.6 cm	Panel decors 1.9 cm	Panel decors 2.5 cm	Panel decors 5 cm	Stiles 10 cm	pilasters	Cornice + light pelmet	Units with roller shutter	Front material
	Model	Model number	front colour																				

## Velvet lacquer putty effect / lacquered surface

PG 3 CASA-B	XL 30046	Snow White	R160W	—																			
PG 3 CASA-B	XL 30049	Light Pepper	R218W	—																			
PG 3 CASA-B	XL 30050	Premium white	R039W	—																			
PG 3 CASA-B	XL 30056	White Agate	R178W	—																			
PG 3 CASA-B	XL 30059	Night Green	R245W	—																			
PG 3 CASA-B	XL 30060	Light Grey	R006W	—																			
PG 3 CASA-B	XL 30062	Art Pepper	R230W	—																			
PG 3 CASA-B	XL 30065	Macaron	R076W	—																			
PG 3 CASA-B	XL 30066	Light Nude	R248W	—																			
PG 3 CASA-B	XL 30067	Fango	R263W	—																			
PG 3 CASA-B	XL 30084	Magic-grey	R058W	—																			
PG 3 CASA-B	XL 30095	Graphite Black	R043W	—																			
PG 3 CASA-B	XL 30098	Black	R075W	—																			
PG 3 CASA-B	XL 30099	special colour	R099W	—																			

## wood texture Velvet lacquer / lacquered surface

PG 3 SIGNUM-B	XL 31046	Snow White	R160H	—																			
PG 3 SIGNUM-B	XL 31050	Premium white	R039H	—																			
PG 3 SIGNUM-B	XL 31056	White Agate	R178H	—																			
PG 3 SIGNUM-B	XL 31059	Night Green	R245H	—																			
PG 3 SIGNUM-B	XL 31060	Light Grey	R006H	—																			
PG 3 SIGNUM-B	XL 31062	Art Pepper	R230H	—																			
PG 3 SIGNUM-B	XL 31065	Macaron	R076H	—																			
PG 3 SIGNUM-B	XL 31066	Light Nude	R248H	—																			
PG 3 SIGNUM-B	XL 31067	Fango	R263H	—																			
PG 3 SIGNUM-B	XL 31069	Light Pepper	R218H	—																			
PG 3 SIGNUM-B	XL 31084	Magic-grey	R058H	—																			
PG 3 SIGNUM-B	XL 31095	Graphite Black	R043H	—																			
PG 3 SIGNUM-B	XL 31098	Black	R075H	—																			
PG 3 SIGNUM-B	XL 31099	special colour	R099H	—																			

Also applies to the following models: LUX-B

# Models/surrounding elements

In addition to the model/colour combinations illustrated, any model can be combined with all colours.				Decor group / colour number	Carcasdecor	Visible sides	Plinth	background fillers	Recess back panel	Back cladding	Shelf units	Glass wall units (IDF...)	Container boxes	Panel decors 1.0 cm	Panel decors 1.6 cm	Panel decors 1.9 cm	Panel decors 2.5 cm	Panel decors 5 cm	Stiles 10 cm	pilasters	Cornice + light pelmet	Units with roller shutter	Front material
Price groups	Model	Model number	front colour																				

**Micro textured lacquer / lacquered surface**

PG 3 ARTE-S	XL 3246	Snow White	S160P	—																			
PG 3 ARTE-S	XL 3249	Light Pepper	S218P	—																			
PG 3 ARTE-S	XL 3250	Premium white	S039P	—																			
PG 3 ARTE-S	XL 3256	White Agate	S178P	—																			
PG 3 ARTE-S	XL 3259	Night Green	S245P	—																			
PG 3 ARTE-S	XL 3260	Light Grey	S006P	—																			
PG 3 ARTE-S	XL 3261	Art Pepper	S230P	—																			
PG 3 ARTE-S	XL 3265	Macaron	S076P	—																			
PG 3 ARTE-S	XL 3266	Light Nude	S248P	—																			
PG 3 ARTE-S	XL 3267	Fango	S263P	—																			
PG 3 ARTE-S	XL 3284	Magic-grey	S058P	—																			
PG 3 ARTE-S	XL 3295	Graphite Black	S043P	—																			
PG 3 ARTE-S	XL 3298	Black	S075P	—																			
PG 3 ARTE-S	XL 3299	special colour	S099P	—																		—	

Also applies to the following models: ROMA-S , VILLAGE 15-S , SOFIE-S , PALERMO-S , NOBEL-S , YORK-S , CHALET-S , ATLANTA-S , ORLANDO-S

**Velvet lacquer / lacquered surface**

PG 3 ARTE-B	XL 3380	Snow White	B160F	—																			
PG 3 ARTE-B	XL 3382	Premium white	B039F	—																			
PG 3 ARTE-B	XL 3384	White Agate	B178F	—																			
PG 3 ARTE-B	XL 3385	Light Grey	B006F	—																			
PG 3 ARTE-B	XL 3386	Macaron	B076F	—																			
PG 3 ARTE-B	XL 3388	Magic-grey	B058F	—																			
PG 3 ARTE-B	XL 3387	Light Pepper	B218F	—																			
PG 3 ARTE-B	XL 3391	Night Green	B245F	—																			
PG 3 ARTE-B	XL 3394	Art Pepper	B230F	—																			
PG 3 ARTE-B	XL 3395	Graphite Black	B043F	—																			
PG 3 ARTE-B	XL 3396	Light Nude	B248F	—																			
PG 3 ARTE-B	XL 3397	Fango	B263F	—																			
PG 3 ARTE-B	XL 3398	Black	B075F	—																			
PG 3 ARTE-B	XL 3399	special colour	B099F	—																		—	

Also applies to the following models: ROMA-B , VILLAGE 15-B , SOFIE-B , PALERMO-B , NOBEL-B , YORK-B , CHALET-B , ATLANTA-B , ORLANDO-B

# Models/surrounding elements

Price groups	In addition to the model/colour combinations illustrated, any model can be combined with all colours.			Decor group / colour number	Carcasdecor	Visible sides	Plinth	background fillers	Recess back panel	Back cladding	Shelf units	Glass wall units (IDE...)	Container boxes	Panel decors 1.0 cm	Panel decors 1.6 cm	Panel decors 1.9 cm	Panel decors 2.5 cm	Panel decors 5 cm	Stiles 10 cm	pilasters	Cornice + light pelmet	Units with roller shutter	Front material
	Model	Model number	front colour																				

## Premium matt lacquer / lacquered surface

PG 5 NEW OPAL-M	XL 52050	Premium white	MP039	—																				
PG 5 NEW OPAL-M	XL 52046	Snow White	MP160	—																				
PG 5 NEW OPAL-M	XL 52056	White Agate	MP178	—																				
PG 5 NEW OPAL-M	XL 52059	Night Green	MP245	—																				
PG 5 NEW OPAL-M	XL 52060	Light Grey	MP006	—																				
PG 5 NEW OPAL-M	XL 52062	Art Pepper	MP230	—																				
PG 5 NEW OPAL-M	XL 52065	Macaron	MP076	—																				
PG 5 NEW OPAL-M	XL 52066	Light Nude	MP248	—																				
PG 5 NEW OPAL-M	XL 52067	Fango	MP263	—																				
PG 5 NEW OPAL-M	XL 52069	Light Pepper	MP218	—																				
PG 5 NEW OPAL-M	XL 52084	Magic-grey	MP058	—																				
PG 5 NEW OPAL-M	XL 52095	Graphite Black	MP043	—																				
PG 5 NEW OPAL-M	XL 52098	Black	MP075	—																				
PG 5 NEW OPAL-M	XL 52099	special colour	MP099	—																				

## High-gloss lacquer / lacquered surface

PG 5 OPAL-H	XL 5650	Premium white	H039H	—																				
PG 5 OPAL-H	XL 5646	Snow White	H160H	—																				
PG 5 OPAL-H	XL 5656	White Agate	H178H	—																				
PG 5 OPAL-H	XL 5659	Night Green	H245H	—																				
PG 5 OPAL-H	XL 5660	Light Grey	H006H	—																				
PG 5 OPAL-H	XL 5661	Art Pepper	H230H	—																				
PG 5 OPAL-H	XL 5665	Macaron	H076H	—																				
PG 5 OPAL-H	XL 5666	Light Nude	H248H	—																				
PG 5 OPAL-H	XL 5667	Fango	H263H	—																				
PG 5 OPAL-H	XL 5669	Light Pepper	H218H	—																				
PG 5 OPAL-H	XL 5684	Magic-grey	H058H	—																				
PG 5 OPAL-H	XL 5695	Graphite Black	H043H	—																				
PG 5 OPAL-H	XL 5698	Black	H075H	—																				
PG 5 OPAL-H	XL 5699	special colour	H099H	—																				

# Models/surrounding elements

Price groups	Model	Model number	front colour	Decor group / colour number	Carcasdecorors	Visible sides	Plinth	background fillers	Recess back panel	Back cladding	Shelf units	Glass wall units (IDF...)	Container boxes	Panel decors 1.0 cm	Panel decors 1.6 cm	Panel decors 1.9 cm	Panel decors 2.5 cm	Panel decors 5 cm	Stiles 10 cm	pilasters	Cornice + light pelmet	Units with roller shutter	Front material

## wood texture / Oak veneer

PG 5 MALMÖ	XL 5920	Premium white lacquered	F039S	—																			
PG 5 MALMÖ	XL 5921	Moderno Rustico oak	F279K	—																			
PG 5 MALMÖ	XL 5924	Urban Oak stained	F261K	—																			
PG 5 MALMÖ	XL 5925	Black lacquered	F075S	—																			
PG 5 MALMÖ	XL 5926	Light Nude lacquered	F248S	—																			
PG 5 MALMÖ	XL 5927	Fango lacquered	F263S	—																			
PG 5 MALMÖ	XL 5929	Night green lacquered	F245S	—																			
PG 5 MALMÖ	XL 5940	oak Art Pepper	F230S	—																			
PG 5 MALMÖ	XL 5965	Macaron lacquered	F076K	—																			
PG 5 MALMÖ	XL 5969	Light Pepper lacquered	F218S	—																			
PG 5 MALMÖ	XL 5970	silk grey stained	F058K	—																			
PG 5 MALMÖ	XL 5975	natural stained	F213K	—																			
PG 5 MALMÖ	XL 5980	coffee brown stained	F214K	—																			
PG 5 MALMÖ	XL 5995	Graphite Black lacquered	F043S	—																			
PG 5 MALMÖ	XL 5996	Gavi oak stained	F258K	—																			
PG 5 MALMÖ	XL 5998	dark oak stained	F259K	—																			
PG 5 MALMÖ	XL 5949	special colour lacquered	F099K	—																			

Also applies to the following models: PADUA , OSLO 15 , BERGEN , CHICAGO

## wood texture / Bavaria oak veneer

PG 6 BAVARIA	XL 6826	Premium white lacquered	Z039S	—																			
PG 6 BAVARIA	XL 6827	Fango, lacquered	Z263S	—																			
PG 6 BAVARIA	XL 6828	Black lacquered	Z075S	—																			
PG 6 BAVARIA	XL 6829	Night green lacquered	Z245S	—																			
PG 6 BAVARIA	XL 6831	Moderno Rustico, stained	Z279K	—																			
PG 6 BAVARIA	XL 6832	natural stained	Z213K	—																			
PG 6 BAVARIA	XL 6834	coffee brown stained	Z214K	—																			
PG 6 BAVARIA	XL 6838	Gavi oak, stained	Z258K	—																			
PG 6 BAVARIA	XL 6839	Light Pepper lacquered	Z218S	—																			
PG 6 BAVARIA	XL 6840	silk grey stained	Z058K	—																			
PG 6 BAVARIA	XL 6845	Graphite Black lacquered	Z043S	—																			
PG 6 BAVARIA	XL 6847	Art Pepper lacquered	Z230S	—																			
PG 6 BAVARIA	XL 6851	Dark oak stained	Z259K	—																			
PG 6 BAVARIA	XL 6852	Macaron lacquered	Z076K	—																			
PG 6 BAVARIA	XL 6854	Urban Oak stained	Z261K	—																			
PG 6 BAVARIA	XL 6856	Light Nude lacquered	Z248S	—																			
PG 6 BAVARIA	XL 6849	special colour lacquered	Z099K	—																			

Also applies to the following models: MUNICH , TESSIN 15 , LUGANO

# Decor group overview

Decor group / colour number	Surface																				
		Carcasdecorors	Visible sides	Plinth	background fillers	Recess back panel	Back cladding	Shelf units	Glass wall units (IDF...)	Container boxes	Panel decors 1.0 cm	Panel decors 1.6 cm	Panel decors 1.9 cm	Panel decors 2.5 cm	Panel decors 5 cm	Stiles 10 cm	plasters	Cornice + light pelmet	Units with roller shutter	Support panel	
<b>M 10</b>	<b>Carcase decors (decor group K)</b>																				
K006P	Light Grey	minipearl texture																			
K023P	Stainless Steel Colour	Soft Pearl																			
K039P	Premium white	minipearl texture																			
K043P	Graphite Black	Soft Pearl																			
K058P	Magic-grey	minipearl texture																			
K075P	Black	Soft Pearl																			
K076P	Macaron	Soft Pearl																			
K160F	Snow White	Smooth																			
K178F	White Agate	Smooth																			
K218P	Light Pepper	Soft Pearl																			
K230P	Art Pepper	Soft Pearl																			
K235P	Titan Steel	metal brush																			
K248P	Light Nude	Soft Pearl																			
K263P	Fango	micro texture																			
K039G	Premium white glossy	Smooth																			
K160G	Snow White Gloss	Smooth																			
K005S	Castell Oak Repro.	wood texture																			
K190S	Mammoth oak repro. natural	wood texture																			
K199S	Piemont Oak Repro	Deepskin																			
K216S	natural mountain oak effect	wood texture																			
K229S	Classic Oak effect	Synchronised grain structure																			
K236S	Diamond oak effect	wood texture																			
K247S	Dark Maron effect	wood texture																			
K262S	Royal Oak effect	wood texture																			
K269S	Mountain Wood	wood texture																			
K270S	Elegant walnut effect	wood texture																			
<b>M 20</b>	<b>Accessory decors (decor group D)</b>	<b>Surface and colour identical on both sides</b>																			
D147S	Burnt Wood effect	wood texture																			
D149W	Brown concrete effect	textured																			
D176S	Sherwood Oak Repro. Black	wood texture																			
D187W	Concrete effect opal	textured																			
D188W	Concrete effect pearl grey	textured																			
D202S	Sherwood Oak Repro Sepia Grey	wood texture																			
D212W	graphite concrete effect	textured																			
D224S	Bordeaux oak effect	wood texture																			
D250S	Black Oak effect	wood texture																			
D251S	Seal Oak effect	wood texture																			
D264S	Light oak, grooved look	wood texture with grooved look																			
D265S	Dark oak, grooved look	wood texture with grooved look																			
D271W	Natural sandstone effect	textured																			
D272F	Jade pastel	Smooth																			
<b>M 20</b>	<b>Accessory decors (decor group D)</b>	<b>Front side matt, rear in same colour, textured</b>																			
D039F	Premium white matt	smooth (matt)																			
D160F	Snow white matt	smooth (matt)																			
D178F	White Agate matt	smooth (matt)																			

# Decor group overview

Decor group / colour number			Surface	Carcasdecor	Visible sides	Plinth	background fillers	Recess back panel	Back cladding	Shelf units	Glass wall units (IDF...)	Container boxes	Panel decors 1.0 cm	Panel decors 1.6 cm	Panel decors 1.9 cm	Panel decors 2.5 cm	Panel decors 5 cm	Stiles 10 cm	plasters	Cornice + light pelmet	Units with roller shutter	Support panel		
<b>M 30 RESOPAL PRO (decor group I)</b> Front side <b>super matt</b> , rear texture in same colour																								
I039M	RESOPAL PRO premium white	smooth (matt)																						
I075M	RESOPAL PRO black	smooth (matt)																						
I076M	RESOPAL PRO Macaron powder	smooth (matt)																						
I138M	RESOPAL PRO titanium grey	smooth (matt)																						
I139M	RESOPAL PRO Jura Grey	smooth (matt)																						
I140M	RESOPAL PRO anthracite	smooth (matt)																						
I141M	RESOPAL PRO cool white	smooth (matt)																						
I240M	RESOPAL PRO light powder	smooth (matt)																						
I241M	RESOPAL PRO dark powder	smooth (matt)																						
I253M	RESOPAL PRO Moonlight Green	smooth (matt)																						
I267M	RESOPAL PRO brown powder	smooth (matt)																						
I268M	RESOPAL PRO nature powder	smooth (matt)																						
<b>M 30 HPL PRO (decor group I..H)</b> Front side <b>super matt</b> , rear texture in same colour																								
I273H	Natural onyx effect	smooth (matt)																						
I274H	Navyblue	smooth (matt)																						
I280H	Smoke Powder	smooth (matt)																						
I281H	Ferro black gold	smooth (matt)																						
<b>M 30 PRIMEWOOD (decor group PW)</b>																								
PW258	Gavi oak	Basic Veneer																						
PW259	dark oak	Basic Veneer																						
<b>M 40 DIRECTLACK high-gloss (decor group L)</b> Front side <b>high-gloss lacquered</b> , rear texture in same colour																								
L039H	Premium white	high-gloss lacquered																						
L076H	Macaron	high-gloss lacquered																						
L160H	Snow White	high-gloss lacquered																						
L178H	White Agate	high-gloss lacquered																						
L218H	Light Pepper	high-gloss lacquered																						
L248H	Light Nude	high-gloss lacquered																						
<b>M 40 DIRECTLACK matt (decor group A)</b> Front side <b>matt lacquered</b> , rear texture in same colour																								
A039M	Premium white	matt lacquered																						
A043M	Graphite Black	matt lacquered																						
A075M	Black	matt lacquered																						
A076M	Macaron	matt lacquered																						
A160M	Snow White	matt lacquered																						
A178M	White Agate	matt lacquered																						
A218M	Light Pepper	matt lacquered																						
A230M	Art Pepper	matt lacquered																						
A248M	Light Nude	matt lacquered																						
A263M	Fango	matt lacquered																						



# Decor group overview

Decor group / colour number	Surface	Carcasdecor	Visible sides	Plinth	background fillers	Recess back panel	Back cladding	Shelf units	Glass wall units (IDF...)	Container boxes	Panel decors 1.0 cm	Panel decors 1.6 cm	Panel decors 1.9 cm	Panel decors 2.5 cm	Panel decors 5 cm	Stiles 10 cm	plasters	Cornice + light pelmet	Units with roller shutter	Support panel
<b>M 50</b>	<b>Micro textured lacquer colours (decor group S)</b>																			
S006P	Light Grey	Micro textured lacquer	—																	
S039P	Premium white	Micro textured lacquer	—																	
S043P	Graphite Black	Micro textured lacquer	—																	
S058P	Magic-grey	Micro textured lacquer	—																	
S075P	Black	Micro textured lacquer	—																	
S076P	Macaron	Micro textured lacquer	—																	
S160P	Snow White	Micro textured lacquer	—																	
S178P	White Agate	Micro textured lacquer	—																	
S218P	Light Pepper	Micro textured lacquer	—																	
S230P	Art Pepper	Micro textured lacquer	—																	
S245P	Night Green	Micro textured lacquer	—																	
S248P	Light Nude	Micro textured lacquer	—																	
S263P	Fango	Micro textured lacquer	—																	
S099P	Special colours	Micro textured lacquer	—																	—
<b>M 50</b>	<b>Velvet lacquer colours (decor group B)</b>																			
B006F	Light Grey	Velvet lacquer	—																	
B039F	Premium white	Velvet lacquer	—																	
B043F	Graphite Black	Velvet lacquer	—																	
B058F	Magic-grey	Velvet lacquer	—																	
B075F	Black	Velvet lacquer	—																	
B076F	Macaron	Velvet lacquer	—																	
B160F	Snow White	Velvet lacquer	—																	
B178F	White Agate	Velvet lacquer	—																	
B218F	Light Pepper	Velvet lacquer	—																	
B230F	Art Pepper	Velvet lacquer	—																	
B245F	Night Green	Velvet lacquer	—																	
B248F	Light Nude	Velvet lacquer	—																	
B263F	Fango	Velvet lacquer	—																	
B099F	Special colours	Velvet lacquer	—																	—
<b>M 50</b>	<b>Velvet lacquer putty effect (decor group RW)</b>																			
R006W	Light Grey	Velvet lacquer putty effect	—																	
R039W	Premium white	Velvet lacquer putty effect	—																	
R043W	Graphite Black	Velvet lacquer putty effect	—																	
R058W	Magic-grey	Velvet lacquer putty effect	—																	
R075W	Black	Velvet lacquer putty effect	—																	
R076W	Macaron	Velvet lacquer putty effect	—																	
R160W	Snow White	Velvet lacquer putty effect	—																	
R178W	White Agate	Velvet lacquer putty effect	—																	
R218W	Light Pepper	Velvet lacquer putty effect	—																	
R230W	Art Pepper	Velvet lacquer putty effect	—																	
R245W	Night Green	Velvet lacquer putty effect	—																	
R248W	Light Nude	Velvet lacquer putty effect	—																	
R263W	Fango	Velvet lacquer putty effect	—																	
R099W	Special colours	Velvet lacquer putty effect	—																	—

# Decor group overview

Decor group / colour number	Surface																			
		Carcasdecor	Visible sides	Plinth	background fillers	Recess back panel	Back cladding	Shelf units	Glass wall units (IDF...)	Container boxes	Panel decors 1.0 cm	Panel decors 1.6 cm	Panel decors 1.9 cm	Panel decors 2.5 cm	Panel decors 5 cm	Stiles 10 cm	plasters	Cornice + light pelmet	Units with roller shutter	Support panel
<b>M 50 Velvet lacquer colours wood texture (decor group RH)</b>																				
R006H Light Grey	Velvet lacquer wood texture	-	-	-	-	-	-	-	-	-	-	-	-	-	-	-	-	-	-	-
R039H Premium white	Velvet lacquer wood texture	-	-	-	-	-	-	-	-	-	-	-	-	-	-	-	-	-	-	-
R043H Graphite Black	Velvet lacquer wood texture	-	-	-	-	-	-	-	-	-	-	-	-	-	-	-	-	-	-	-
R058H Magic-grey	Velvet lacquer wood texture	-	-	-	-	-	-	-	-	-	-	-	-	-	-	-	-	-	-	-
R075H Black	Velvet lacquer wood texture	-	-	-	-	-	-	-	-	-	-	-	-	-	-	-	-	-	-	-
R076H Macaron	Velvet lacquer wood texture	-	-	-	-	-	-	-	-	-	-	-	-	-	-	-	-	-	-	-
R160H Snow White	Velvet lacquer wood texture	-	-	-	-	-	-	-	-	-	-	-	-	-	-	-	-	-	-	-
R178H White Agate	Velvet lacquer wood texture	-	-	-	-	-	-	-	-	-	-	-	-	-	-	-	-	-	-	-
R218H Light Pepper	Velvet lacquer wood texture	-	-	-	-	-	-	-	-	-	-	-	-	-	-	-	-	-	-	-
R230H Art Pepper	Velvet lacquer wood texture	-	-	-	-	-	-	-	-	-	-	-	-	-	-	-	-	-	-	-
R245H Night Green	Velvet lacquer wood texture	-	-	-	-	-	-	-	-	-	-	-	-	-	-	-	-	-	-	-
R248H Light Nude	Velvet lacquer wood texture	-	-	-	-	-	-	-	-	-	-	-	-	-	-	-	-	-	-	-
R263H Fango	Velvet lacquer wood texture	-	-	-	-	-	-	-	-	-	-	-	-	-	-	-	-	-	-	-
R099H Special colours	Velvet lacquer wood texture	-	-	-	-	-	-	-	-	-	-	-	-	-	-	-	-	-	-	-
<b>M 50 Soft lacquer colours (decor group P)</b>																				
P039M Premium white	Soft lacquer	-	-	-	-	-	-	-	-	-	-	-	-	-	-	-	-	-	-	-
<b>M 60 SMARTGLAS, high-gloss (decor group QH)</b> Front side high-gloss, rear texture in same colour																				
Q075H Black	high-gloss	-	-	-	-	-	-	-	-	-	-	-	-	-	-	-	-	-	-	-
Q160H Snow White	high-gloss	-	-	-	-	-	-	-	-	-	-	-	-	-	-	-	-	-	-	-
Q178H White Agate	high-gloss	-	-	-	-	-	-	-	-	-	-	-	-	-	-	-	-	-	-	-
Q191H Sand grey	high-gloss	-	-	-	-	-	-	-	-	-	-	-	-	-	-	-	-	-	-	-
Q200H Carrara white	high-gloss	-	-	-	-	-	-	-	-	-	-	-	-	-	-	-	-	-	-	-
Q201H Cream	high-gloss	-	-	-	-	-	-	-	-	-	-	-	-	-	-	-	-	-	-	-
<b>M 60 SMARTGLAS, satin-finish (decor group QM)</b> Front side satin-finish, rear texture in same colour																				
Q075M Black	satin finish	-	-	-	-	-	-	-	-	-	-	-	-	-	-	-	-	-	-	-
Q160M Snow White	satin finish	-	-	-	-	-	-	-	-	-	-	-	-	-	-	-	-	-	-	-
Q178M White Agate	satin finish	-	-	-	-	-	-	-	-	-	-	-	-	-	-	-	-	-	-	-
Q191M Sand grey	satin finish	-	-	-	-	-	-	-	-	-	-	-	-	-	-	-	-	-	-	-
Q192M Taupe	satin finish	-	-	-	-	-	-	-	-	-	-	-	-	-	-	-	-	-	-	-
Q200M Carrara white	satin finish	-	-	-	-	-	-	-	-	-	-	-	-	-	-	-	-	-	-	-
Q201M Cream	satin finish	-	-	-	-	-	-	-	-	-	-	-	-	-	-	-	-	-	-	-
Q234M Carbon metallic	satin finish	-	-	-	-	-	-	-	-	-	-	-	-	-	-	-	-	-	-	-
Q244M Aqua	satin finish	-	-	-	-	-	-	-	-	-	-	-	-	-	-	-	-	-	-	-
Q254M Black metallic	satin finish	-	-	-	-	-	-	-	-	-	-	-	-	-	-	-	-	-	-	-
Q255M Champagne metallic	satin finish	-	-	-	-	-	-	-	-	-	-	-	-	-	-	-	-	-	-	-
Q256M Grey metallic	satin finish	-	-	-	-	-	-	-	-	-	-	-	-	-	-	-	-	-	-	-
Q277M Silk Metallic	satin finish	-	-	-	-	-	-	-	-	-	-	-	-	-	-	-	-	-	-	-
Q278M Bronze Metallic	satin finish	-	-	-	-	-	-	-	-	-	-	-	-	-	-	-	-	-	-	-



# Decor group overview

Decor group / colour number	Surface																		
		Carcasdecor	Visible sides	Plinth	background fillers	Recess back panel	Back cladding	Shelf units	Glass wall units (IDF...)	Container boxes	Panel decors 1.0 cm	Panel decors 1.6 cm	Panel decors 1.9 cm	Panel decors 2.5 cm	Stiles 10 cm	piasters	Cornice + light pelmet	Units with roller shutter	Support panel
MP043 Graphite Black	Premium matt lacquer	—	—	—	—	—	—	—	—	—	—	—	—	—	—	—	—	—	—
MP058 Magic-grey	Premium matt lacquer	—	—	—	—	—	—	—	—	—	—	—	—	—	—	—	—	—	—
MP075 Black	Premium matt lacquer	—	—	—	—	—	—	—	—	—	—	—	—	—	—	—	—	—	—
MP076 Macaron	Premium matt lacquer	—	—	—	—	—	—	—	—	—	—	—	—	—	—	—	—	—	—
MP160 Snow White	Premium matt lacquer	—	—	—	—	—	—	—	—	—	—	—	—	—	—	—	—	—	—
MP178 White Agate	Premium matt lacquer	—	—	—	—	—	—	—	—	—	—	—	—	—	—	—	—	—	—
MP218 Light Pepper	Premium matt lacquer	—	—	—	—	—	—	—	—	—	—	—	—	—	—	—	—	—	—
MP230 Art Pepper	Premium matt lacquer	—	—	—	—	—	—	—	—	—	—	—	—	—	—	—	—	—	—
MP245 Night Green	Premium matt lacquer	—	—	—	—	—	—	—	—	—	—	—	—	—	—	—	—	—	—
MP248 Light Nude	Premium matt lacquer	—	—	—	—	—	—	—	—	—	—	—	—	—	—	—	—	—	—
MP263 Fango	Premium matt lacquer	—	—	—	—	—	—	—	—	—	—	—	—	—	—	—	—	—	—
MP099 Special colours	Premium matt lacquer	—	—	—	—	—	—	—	—	—	—	—	—	—	—	—	—	—	—
<b>M 80 High-gloss lacquer colours (decor group H)</b>																			
H006H Light Grey	High-gloss lacquer	—	—	—	—	—	—	—	—	—	—	—	—	—	—	—	—	—	—
H039H Premium white	High-gloss lacquer	—	—	—	—	—	—	—	—	—	—	—	—	—	—	—	—	—	—
H043H Graphite Black	High-gloss lacquer	—	—	—	—	—	—	—	—	—	—	—	—	—	—	—	—	—	—
H058H Magic-grey	High-gloss lacquer	—	—	—	—	—	—	—	—	—	—	—	—	—	—	—	—	—	—
H075H Black	High-gloss lacquer	—	—	—	—	—	—	—	—	—	—	—	—	—	—	—	—	—	—
H076H Macaron	High-gloss lacquer	—	—	—	—	—	—	—	—	—	—	—	—	—	—	—	—	—	—
H160H Snow White	High-gloss lacquer	—	—	—	—	—	—	—	—	—	—	—	—	—	—	—	—	—	—
H178H White Agate	High-gloss lacquer	—	—	—	—	—	—	—	—	—	—	—	—	—	—	—	—	—	—
H218H Light Pepper	High-gloss lacquer	—	—	—	—	—	—	—	—	—	—	—	—	—	—	—	—	—	—
H230H Art Pepper	High-gloss lacquer	—	—	—	—	—	—	—	—	—	—	—	—	—	—	—	—	—	—
H245H Night Green	High-gloss lacquer	—	—	—	—	—	—	—	—	—	—	—	—	—	—	—	—	—	—
H248H Light Nude	High-gloss lacquer	—	—	—	—	—	—	—	—	—	—	—	—	—	—	—	—	—	—
H263H Fango	High-gloss lacquer	—	—	—	—	—	—	—	—	—	—	—	—	—	—	—	—	—	—
H099H Special colours	High-gloss lacquer	—	—	—	—	—	—	—	—	—	—	—	—	—	—	—	—	—	—
<b>M 80 Veneer colours (decor group O)</b>																			
O170S Antique Oak	Veneer	—	—	—	—	—	—	—	—	—	—	—	—	—	—	—	—	—	—
O197S light Spessart oak	Veneer	—	—	—	—	—	—	—	—	—	—	—	—	—	—	—	—	—	—
O215S larch veneer	Veneer	—	—	—	—	—	—	—	—	—	—	—	—	—	—	—	—	—	—
O232S Spessart-oak leached	Veneer	—	—	—	—	—	—	—	—	—	—	—	—	—	—	—	—	—	—
O233S Spessart-oak Honey	Veneer	—	—	—	—	—	—	—	—	—	—	—	—	—	—	—	—	—	—
O259K Dark oak stained	Brushed veneer	—	—	—	—	—	—	—	—	—	—	—	—	—	—	—	—	—	—
<b>M 90 Worktop decors (decor group A116)</b>																			
1200 Roxano volcano black		—	—	—	—	—	—	—	—	—	—	—	—	—	—	—	—	—	—
1210 Metal Rock anthracite		—	—	—	—	—	—	—	—	—	—	—	—	—	—	—	—	—	—
2032 Wild Oak Repro		—	—	—	—	—	—	—	—	—	—	—	—	—	—	—	—	—	—
2260 Sand beige titanite		—	—	—	—	—	—	—	—	—	—	—	—	—	—	—	—	—	—
2701 snow white spatula look effect		—	—	—	—	—	—	—	—	—	—	—	—	—	—	—	—	—	—
3797 Mocca		—	—	—	—	—	—	—	—	—	—	—	—	—	—	—	—	—	—
4268 natural Green Ceramic		—	—	—	—	—	—	—	—	—	—	—	—	—	—	—	—	—	—
8000 Crystal marble		—	—	—	—	—	—	—	—	—	—	—	—	—	—	—	—	—	—
9200 Cupria marble		—	—	—	—	—	—	—	—	—	—	—	—	—	—	—	—	—	—
9612 Graphite Black stone look		—	—	—	—	—	—	—	—	—	—	—	—	—	—	—	—	—	—
9630 Art Pepper stone look		—	—	—	—	—	—	—	—	—	—	—	—	—	—	—	—	—	—
<b>Special colours</b>																			
U039M Premium white matt with gold-coloured applications		—	—	—	—	—	—	—	—	—	—	—	—	—	—	—	—	—	—

# M 10 Carcase decors (decor group K)

Surface and colour identical on both sides



**K006P** Light Grey

Surface minipearl texture

5 cm wide panels not available



**K023P** Stainless Steel Colour

Surface Soft Pearl



**K039P** Premium white

Surface minipearl texture



**K043P** Graphite Black

Surface Soft Pearl



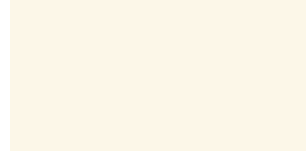
**K058P** Magic-grey

Surface minipearl texture



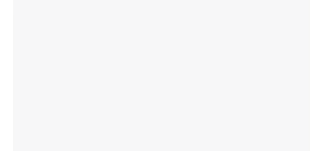
**K075P** Black

Surface Soft Pearl



**K076P** Macaron

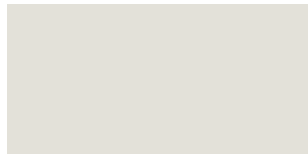
Surface Soft Pearl



**K160F** Snow White

Surface Smooth

Pilasters available



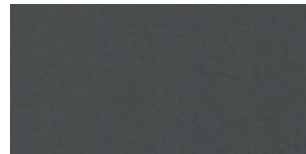
**K178F** White Agate

Surface Smooth



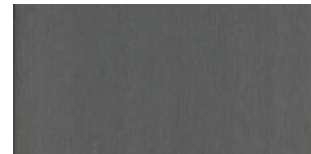
**K218P** Light Pepper

Surface Soft Pearl



**K230P** Art Pepper

Surface Soft Pearl



**K235P** Titan Steel

Surface metal brush



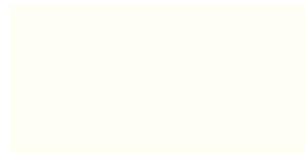
**K248P** Light Nude

Surface Soft Pearl



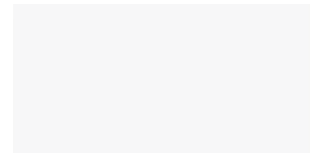
**K263P** Fango

Surface micro texture



**K039G** Premium white glossy

Surface Smooth



**K160G** Snow White Gloss

Surface Smooth



**K005S** Castell Oak Repro.

Surface wood texture



**K190S** Mammoth oak repro. natural

Surface wood texture



**K199S** Piemont Oak Repro

Surface Deepskin



**K216S** natural mountain oak effect

Surface wood texture



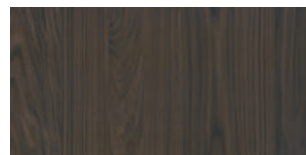
**K229S** Classic Oak effect

Surface Synchronised grain structure



**K236S** Diamond oak effect

Surface wood texture



**K247S** Dark Maron effect

Surface wood texture



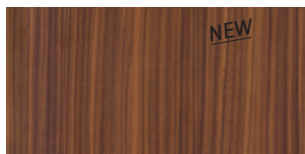
**K262S** Royal Oak effect

Surface wood texture



**K269S** Mountain Wood

Surface wood texture



**K270S** Elegant walnut effect

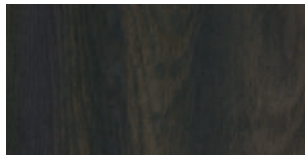
Surface wood texture

## Available accessory elements (decor group K)

Carcasedecors	Visible sides	Plinth	background fillers	Recess back panel	Back cladding	Shelf units	Glass wall units (IDF..)	Container boxes	Panel decors 1.0 cm	Panel decors 1.6 cm	Panel decors 1.9 cm	Panel decors 2.5 cm	Panel decors 5 cm	Stiles 10 cm	pilasters	Cornice + light pelmet	Units with roller shutter
X	X	X	X	X	X	X	X	-	-	X	X	X	X	X	-	X	X

# M 20 Accessory decors (decor group D)

Surface and colour identical on both sides



D147S Burnt Wood effect

Surface wood texture



D149W Brown concrete effect

Surface textured

Panels 2.5 cm wide available



D176S Sherwood Oak Repr. Black

Surface wood texture

Not available for: Recess cladding



D187W Concrete effect opal

Surface textured

Panels 2.5 cm wide available



D188W Concrete effect pearl grey

Surface textured

Panels 2.5 cm wide available



D202S Sherwood Oak Repr. Sepia Grey

Surface wood texture

Not available for: Recess cladding



D212W graphite concrete effect

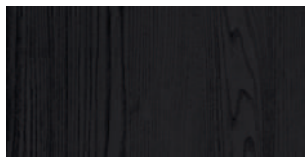
Surface textured

Panels 2.5 cm wide available



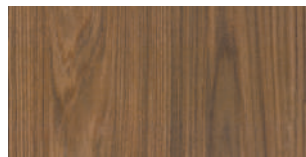
D224S Bordeaux oak effect

Surface wood texture



D250S Black Oak effect

Surface wood texture



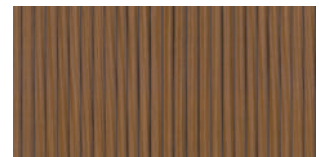
D251S Seal Oak effect

Surface wood texture



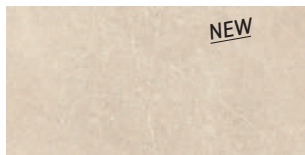
D264S Light oak, grooved look

Surface wood texture with grooved look



D265S Dark oak, grooved look

Surface wood texture with grooved look



D271W Natural sandstone effect

Surface textured



D272F Jade pastel

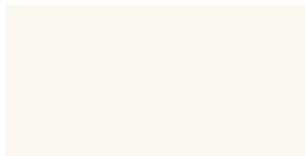
Surface Smooth

## Available accessory elements (decor group D)

Carcasdecor	Visible sides	Plinth	background fillers	Recess back panel	Back cladding	Shelf units	Glass wall units (IDF..)	Container boxes	Panel decors 1.0 cm	Panel decors 1.6 cm	Panel decors 1.9 cm	Panel decors 2.5 cm	Panel decors 5 cm	Stiles 10 cm	pilasters	Cornice + light pelmet	Units with roller shutter
-	X	X	X	X	X	-	-	-	-	X	-	X	-	X	-	-	-

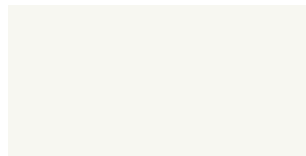
## M 20 Accessory decors (decor group D)

Front side matt, rear in same colour, textured



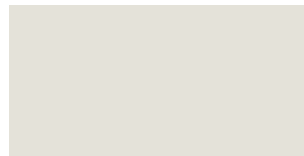
D039F Premium white matt

Surface smooth (matt)



D160F Snow white matt

Surface smooth (matt)



D178F White Agate matt

Surface smooth (matt)

## Available accessory elements (decor group D)

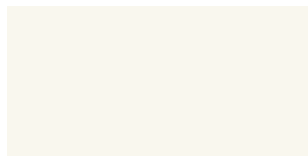
Carcasdecor	Visible sides	Plinth	background fillers	Recess back panel	Back cladding	Shelf units	Glass wall units (IDF..)	Container boxes	Panel decors 1.0 cm	Panel decors 1.6 cm	Panel decors 1.9 cm	Panel decors 2.5 cm	Panel decors 5 cm	Stiles 10 cm	pilasters	Cornice + light pelmet	Units with roller shutter
-	X	X	X	-	X	-	-	-	-	X	-	-	-	X	-	-	-



# M 30 RESOPAL PRO (decor group I)

Front side super matt, rear texture in same colour

ORIGINAL  
RESOPAL®



**I039M RESOPAL PRO premium white**  
Surface smooth (matt)



**I075M RESOPAL PRO black**  
Surface smooth (matt)



**I138M RESOPAL PRO titanium grey**  
Surface smooth (matt)



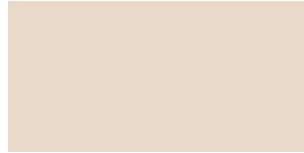
**I139M RESOPAL PRO Jura Grey**  
Surface smooth (matt)



**I140M RESOPAL PRO anthracite**  
Surface smooth (matt)



**I141M RESOPAL PRO cool white**  
Surface smooth (matt)



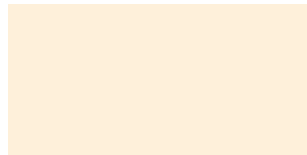
**I240M RESOPAL PRO light powder**  
Surface smooth (matt)



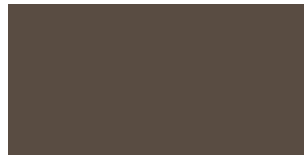
**I241M RESOPAL PRO dark powder**  
Surface smooth (matt)



**I253M RESOPAL PRO Moonlight Green**  
Surface smooth (matt)



**I076M RESOPAL PRO Macaron powder**  
Surface smooth (matt)



**I267M RESOPAL PRO brown powder**  
Surface smooth (matt)



**I268M RESOPAL PRO nature powder**  
Surface smooth (matt)

## Available accessory elements (decor group I)

Carcasdecor	Visible sides	Plinth	background fillers	Recess back panel	Back cladding	Shelf units	Glass wall units (IDF...)	Container boxes	Panel decors 1.0 cm	Panel decors 1.6 cm	Panel decors 1.9 cm	Panel decors 2.5 cm	Panel decors 5 cm	Stiles 10 cm	pilasters	Cornice + light pelmet	Units with roller shutter
-	X	X	X	X	X	-	-	-	-	X	-	-	-	X	-	-	-

## M 30 HPL PRO (decor group I..H)

Front side **super matt**, rear texture in same colour



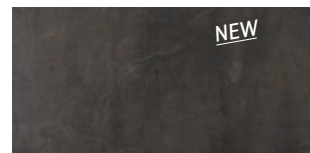
**I273H Natural onyx effect**  
Surface smooth (matt)



**I274H Navyblue**  
Surface smooth (matt)



**I280H Smoke Powder**  
Surface smooth (matt)



**I281H Ferro black gold**  
Surface smooth (matt)

## Available accessory elements (decor group I..H)

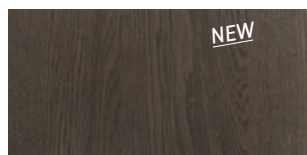
Carcasdecor	Visible sides	Plinth	background fillers	Recess back panel	Back cladding	Shelf units	Glass wall units (IDF...)	Container boxes	Panel decors 1.0 cm	Panel decors 1.6 cm	Panel decors 1.9 cm	Panel decors 2.5 cm	Panel decors 5 cm	Stiles 10 cm	pilasters	Cornice + light pelmet	Units with roller shutter
-	X	X	X	X	X	-	-	-	-	X	-	-	-	X	-	-	-

## M 30 PRIMEWOOD (decor group PW)

Basic Veneer



**PW258 Gavi oak**  
Surface Basic Veneer



**PW259 dark oak**  
Surface Basic Veneer

## Available accessory elements (decor group PW)

Carcasdecor	Visible sides	Plinth	background fillers	Recess back panel	Back cladding	Shelf units	Glass wall units (IDF...)	Container boxes	Panel decors 1.0 cm	Panel decors 1.6 cm	Panel decors 1.9 cm	Panel decors 2.5 cm	Panel decors 5 cm	Stiles 10 cm
-	X	X	X	-	X	-	-	-	-	X	-	-	-	X



# M 40 DIRECTLACK high-gloss (decor group L)

Front side high-gloss lacquered, rear texture in same colour

DIRECT  
LACK



L039H Premium white

Surface high-gloss lacquered



L076H Macaron

Surface high-gloss lacquered



L160H Snow White

Surface high-gloss lacquered



L178H White Agate

Surface high-gloss lacquered



L218H Light Pepper

Surface high-gloss lacquered



L248H Light Nude

Surface high-gloss lacquered

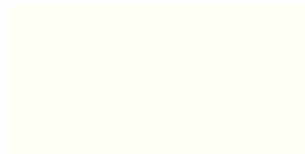
## Available accessory elements (decor group L)

Carcasedecors	Visible sides	Plinth	background fillers	Recess back panel	Back cladding	Shelf units	Glass wall units (IDF...)	Container boxes	Panel decors 1.0 cm	Panel decors 1.6 cm	Panel decors 1.9 cm	Panel decors 2.5 cm	Panel decors 5 cm	Stiles 10 cm	pilasters	Cornice + light pelmet	Units with roller shutter
-	X	X	X	-	X	-	-	-	-	X	-	-	-	-	-	-	-

# M 40 DIRECTLACK matt (decor group A)

Front side matt lacquered, rear texture in same colour

DIRECT  
LACK



A039M Premium white

Surface matt lacquered



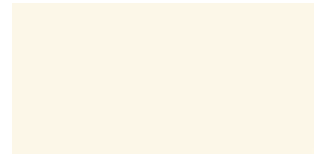
A043M Graphite Black

Surface matt lacquered



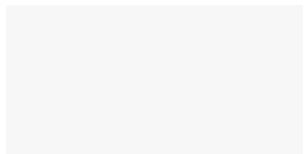
A075M Black

Surface matt lacquered



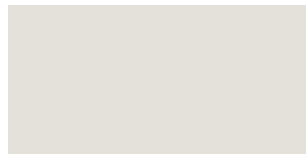
A076M Macaron

Surface matt lacquered



A160M Snow White

Surface matt lacquered



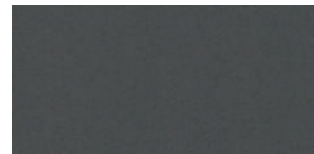
A178M White Agate

Surface matt lacquered



A218M Light Pepper

Surface matt lacquered



A230M Art Pepper

Surface matt lacquered



A248M Light Nude

Surface matt lacquered



A263M Fango

Surface matt lacquered

## Available accessory elements (decor group A)

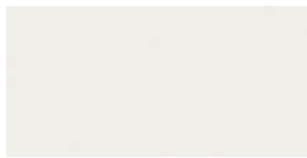
Carcasedecors	Visible sides	Plinth	background fillers	Recess back panel	Back cladding	Shelf units	Glass wall units (IDF...)	Container boxes	Panel decors 1.0 cm	Panel decors 1.6 cm	Panel decors 1.9 cm	Panel decors 2.5 cm	Panel decors 5 cm	Stiles 10 cm	pilasters	Cornice + light pelmet	Units with roller shutter
-	X	X	X	-	X	-	-	-	-	X	-	-	-	-	-	-	-

# M 50 Micro textured lacquer colours (decor group S)



**S006P** Light Grey

Surface Micro textured lacquer



**S039P** Premium white

Surface Micro textured lacquer



**S043P** Graphite Black

Surface Micro textured lacquer



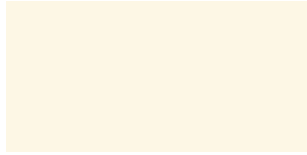
**S058P** Magic-grey

Surface Micro textured lacquer



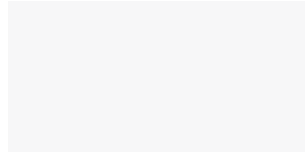
**S075P** Black

Surface Micro textured lacquer



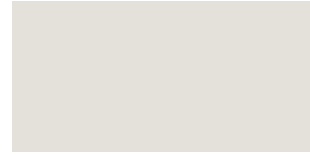
**S076P** Macaron

Surface Micro textured lacquer



**S160P** Snow White

Surface Micro textured lacquer



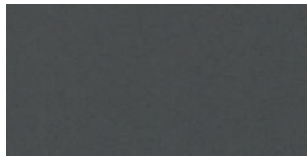
**S178P** White Agate

Surface Micro textured lacquer



**S218P** Light Pepper

Surface Micro textured lacquer



**S230P** Art Pepper

Surface Micro textured lacquer



**S245P** Night Green

Surface Micro textured lacquer



**S248P** Light Nude

Surface Micro textured lacquer



**S263P** Fango

Surface Micro textured lacquer



**S099P** Special colours

Surface Micro textured lacquer

Units with roller shutter not available

Additional price for special paint per commission in microstructure/velvet varnish wood

MP-SOFA

Extra charge 628

Special paint finishes according to RAL, SIKKENS or COLOR NETWORK: Special finishes from the RALClassic, RAL-DESIGN, SIKKENS or COLOR NETWORK colour systems are available for an additional charge per order and colour. The surcharge is calculated from the first article, irrespective of the order volume. If several colours are required in one order, the surcharge must be taken into account for each colour.

Minor color deviations in subsequent deliveries cannot be ruled out. Older sample charts will change when exposed to light.

## Available accessory elements (decor group S)

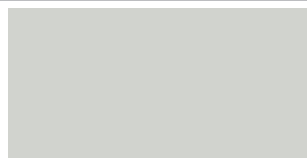
Carcasdecor	Visible sides	Plinth	background fillers	Recess back panel	Back cladding	Shelf units	Glass wall units (IDF..)	Container boxes	Panel decors 1.0 cm	Panel decors 1.6 cm	Panel decors 1.9 cm	Panel decors 2.5 cm	Panel decors 5 cm	Stiles 10 cm	plasters	Cornice + light pelmet	Units with roller shutter
-	X	X	X	X	X	X	X	X	X	X	X	X	X	X	X	X	X

Visible sides one side in decor group S, one side in the standard carcass decor from decor group K, front edge in colour tone decor group S

## Colour concept at no extra charge

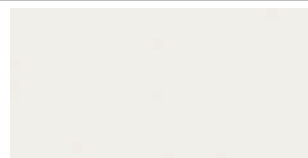
Sealbrown RAL 8019	cristal red SIKKENS C0.60.30	Savona green SIKKENS K0.05.47	Victoria green RAL 180 30 10	Night Red SIKKENS C0.20.20	Blackblue SIKKENS U0.10.20	Jade, pastel RAL 7032	live simple! No. 8

# M 50 Velvet lacquer colours (decor group B)



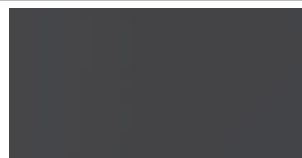
**B006F** Light Grey

Surface Velvet lacquer



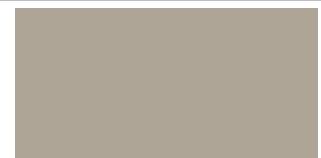
**B039F** Premium white

Surface Velvet lacquer



**B043F** Graphite Black

Surface Velvet lacquer



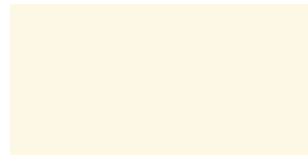
**B058F** Magic-grey

Surface Velvet lacquer



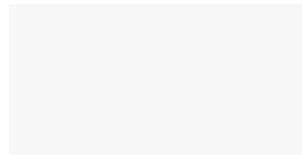
**B075F** Black

Surface Velvet lacquer



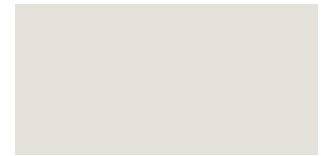
**B076F** Macaron

Surface Velvet lacquer



**B160F** Snow White

Surface Velvet lacquer



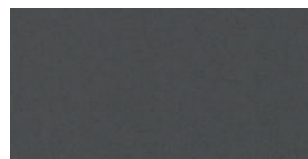
**B178F** White Agate

Surface Velvet lacquer



**B218F** Light Pepper

Surface Velvet lacquer



**B230F** Art Pepper

Surface Velvet lacquer



**B245F** Night Green

Surface Velvet lacquer



**B248F** Light Nude

Surface Velvet lacquer



**B263F** Fango

Surface Velvet lacquer



**B099F** Special colours

Surface Velvet lacquer

Additional price for special paint per commission in microstructure/velvet varnish wood

MP-SOFA

Extra charge

628

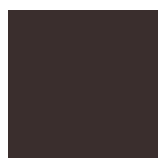
*Special paint finishes according to RAL, SIKKENS or COLOR NETWORK: Special finishes from the RALClassic, RAL-DESIGN, SIKKENS or COLOR NETWORK colour systems are available for an additional charge per order and colour. The surcharge is calculated from the first article, irrespective of the order volume. If several colours are required in one order, the surcharge must be taken into account for each colour. Minor color deviations in subsequent deliveries cannot be ruled out. Older sample charts will change when exposed to light.*

## Available accessory elements (decor group B)

Carcasdecor	Visible sides	Plinth	background fillers	Recess back panel	Back cladding	Shelf units	Glass wall units (IDF..)	Container boxes	Panel decors 1.0 cm	Panel decors 1.6 cm	Panel decors 1.9 cm	Panel decors 2.5 cm	Panel decors 5 cm	Stiles 10 cm	pilasters	Cornice + light pelmet	Units with roller shutter
-	X	X	X	X	X	X	X	X	X	X	X	X	X	X	X	X	X

Visible sides one side in decor group B, one side in the standard carcass decor from decor group K, front edge in colour tone decor group B

## Colour concept at no extra charge



**Sealbrown**  
RAL 8019



**cristal red**  
SIKKENS  
C0.60.30



**Savona green**  
SIKKENS  
K0.05.47



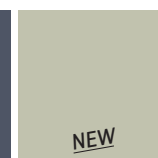
**Victoria green**  
RAL 180 30 10



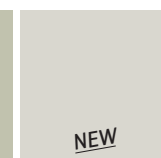
**Night Red**  
SIKKENS  
C0.20.20



**Blackblue**  
SIKKENS  
U0.10.20

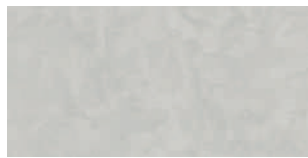


**Jade, pastel**  
RAL 7032



**live simple!**  
No. 8

# M 50 Velvet lacquer putty effect (decor group RW)



**R006W Light Grey**

**Surface** Velvet lacquer putty effect



**R039W Premium white**

**Surface** Velvet lacquer putty effect



**R043W Graphite Black**

**Surface** Velvet lacquer putty effect



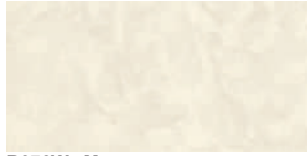
**R058W Magic-grey**

**Surface** Velvet lacquer putty effect



**R075W Black**

**Surface** Velvet lacquer putty effect



**R076W Macaron**

**Surface** Velvet lacquer putty effect



**R160W Snow White**

**Surface** Velvet lacquer putty effect



**R178W White Agate**

**Surface** Velvet lacquer putty effect



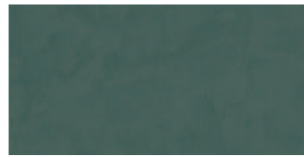
**R218W Light Pepper**

**Surface** Velvet lacquer putty effect



**R230W Art Pepper**

**Surface** Velvet lacquer putty effect



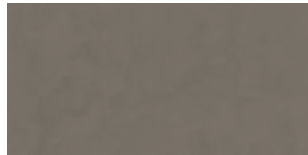
**R245W Night Green**

**Surface** Velvet lacquer putty effect



**R248W Light Nude**

**Surface** Velvet lacquer putty effect



**R263W Fango**

**Surface** Velvet lacquer putty effect



**R099W Special colours**

**Surface** Velvet lacquer putty effect

**Additional price for special paint per commission in microstructure/velvet varnish wood**

**MP-SOFA**

**Extra charge**

628

*Special paint finishes according to RAL, SIKKENS or COLOR NETWORK: Special finishes from the RALClassic, RAL-DESIGN, SIKKENS or COLOR NETWORK colour systems are available for an additional charge per order and colour. The surcharge is calculated from the first article, irrespective of the order volume. If several colours are required in one order, the surcharge must be taken into account for each colour. Minor color deviations in subsequent deliveries cannot be ruled out. Older sample charts will change when exposed to light.*

## Available accessory elements (decor group RW)

Carcasdecor	Visible sides	Plinth	background fillers	Recess back panel	Back cladding	Shelf units	Glass wall units (IDF...)	Container boxes	Panel decors 1.0 cm	Panel decors 1.6 cm	Panel decors 1.9 cm	Panel decors 2.5 cm	Panel decors 5 cm	Stiles 10 cm	pilasters	Cornice + light pelmet	Units with roller shutter
-	X	X	-	-	-	-	-	-	-	X	-	-	-	X	-	-	-

Visible sides both sides in decor group R, front edge in same colour

## Colour concept at no extra charge

Sealbrown RAL 8019	cristal red SIKKENS C0.60.30	Savona green SIKKENS K0.05.47	Victoria green RAL 180 30 10	Night Red SIKKENS C0.20.20	Blackblue SIKKENS U0.10.20	Jade, pastel RAL 7032	live simple! No. 8

# M 50 Velvet lacquer colours wood texture (decor group RH)



R006H Light Grey

Surface Velvet lacquer wood texture



R039H Premium white

Surface Velvet lacquer wood texture



R043H Graphite Black

Surface Velvet lacquer wood texture



R058H Magic-grey

Surface Velvet lacquer wood texture



R075H Black

Surface Velvet lacquer wood texture



R076H Macaron

Surface Velvet lacquer wood texture



R160H Snow White

Surface Velvet lacquer wood texture



R178H White Agate

Surface Velvet lacquer wood texture



R218H Light Pepper

Surface Velvet lacquer wood texture



R230H Art Pepper

Surface Velvet lacquer wood texture



R245H Night Green

Surface Velvet lacquer wood texture



R248H Light Nude

Surface Velvet lacquer wood texture



R263H Fango

Surface Velvet lacquer wood texture



R099H Special colours

Surface Velvet lacquer wood texture

Additional price for special paint per commission in microstructure/velvet varnish wood

MP-SOFA

Extra charge

628

Special paint finishes according to RAL, SIKKENS or COLOR NETWORK:  
Special finishes from the RALClassic, RAL-DESIGN, SIKKENS or COLOR NETWORK colour systems are available for an additional charge per order and colour.  
The surcharge is calculated from the first article, irrespective of the order volume.  
If several colours are required in one order, the surcharge must be taken into account for each colour.  
Minor color deviations in subsequent deliveries cannot be ruled out.  
Older sample charts will change when exposed to light.

## Available accessory elements (decor group RH)

Carcasdecor	Visible sides	Plinth	background fillers	Recess back panel	Back cladding	Shelf units	Glass wall units (IDF...)	Container boxes	Panel decors 1.0 cm	Panel decors 1.6 cm	Panel decors 1.9 cm	Panel decors 2.5 cm	Panel decors 5 cm	Stiles 10 cm	pilasters	Cornice + light pelmet	Units with roller shutter
-	X	X	-	-	-	-	-	-	-	X	-	-	-	X	-	-	-

Visible sides both sides in decor group R, front edge in same colour

## Colour concept at no extra charge



Sealbrown RAL 8019



cristal red SIKKENS C0.60.30



Savona green SIKKENS K0.05.47



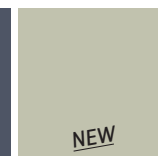
Victoria green RAL 180 30 10



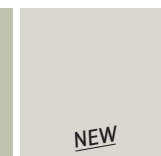
Night Red SIKKENS C0.20.20



Blackblue SIKKENS U0.10.20

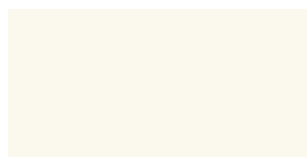


Jade, pastel RAL 7032



live simple! No. 8

## M 50 Soft lacquer colours (decor group P)



P039M Premium white

Surface Soft lacquer

## Available accessory elements (decor group P)

Carcasdecor	Visible sides	Plinth	background fillers	Recess back panel	Back cladding	Shelf units	Glass wall units (IDF...)	Container boxes	Panel decors 1.0 cm	Panel decors 1.6 cm	Panel decors 1.9 cm	Panel decors 2.5 cm	Panel decors 5 cm	Stiles 10 cm	pilasters	Cornice + light pelmet	Units with roller shutter
-	X	-	-	-	-	-	-	-	-	X	-	-	-	-	-	-	-

# M 60 SMARTGLAS, high-gloss (decor group QH)

Front side high-gloss, rear texture in same colour

SMART  
GLAS



Q075H Black

Surface high-gloss



Q160H Snow White

Surface high-gloss



Q178H White Agate

Surface high-gloss



Q191H Sand grey

Surface high-gloss



Q200H Carrara white

Surface high-gloss



Q201H Cream

Surface high-gloss

## Available accessory elements (decor group QH)

Carcasdecor	Visible sides	Plinth	background fillers	Recess back panel	Back cladding	Shelf units	Glass wall units (IDF..)	Container boxes	Panel decors 1.0 cm	Panel decors 1.6 cm	Panel decors 1.9 cm	Panel decors 2.5 cm	Panel decors 5 cm	Stiles 10 cm	pilasters	Cornice + light pelmet	Units with roller shutter
-	X	X	X	X	X	-	-	-	-	X	-	-	-	X	-	-	-

# M 60 SMARTGLAS, satin-finish (decor group QM)

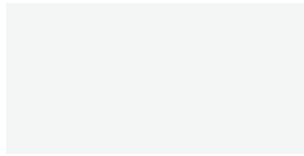
Front side satin-finish, rear texture in same colour

SMART  
GLAS



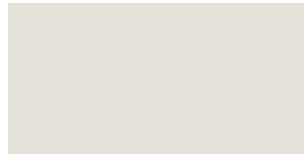
Q075M Black

Surface satin finish



Q160M Snow White

Surface satin finish



Q178M White Agate

Surface satin finish



Q191M Sand grey

Surface satin finish



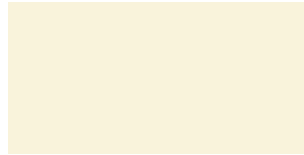
Q192M Taupe

Surface satin finish



Q200M Carrara white

Surface satin finish



Q201M Cream

Surface satin finish



Q234M Carbon metallic

Surface satin finish



Q244M Aqua

Surface satin finish



Q254M Black metallic

Surface satin finish



Q255M Champagne metallic

Surface satin finish



Q256M Grey metallic

Surface satin finish



Q277M Silk Metallic

Surface satin finish



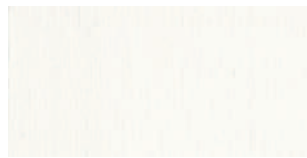
Q278M Bronze Metallic

Surface satin finish

## Available accessory elements (decor group QM)

Carcasdecor	Visible sides	Plinth	background fillers	Recess back panel	Back cladding	Shelf units	Glass wall units (IDF..)	Container boxes	Panel decors 1.0 cm	Panel decors 1.6 cm	Panel decors 1.9 cm	Panel decors 2.5 cm	Panel decors 5 cm	Stiles 10 cm	pilasters	Cornice + light pelmet	Units with roller shutter
-	X	X	X	X	X	-	-	-	-	X	-	-	-	X	-	-	-

# M 70 Veneer colours (decor group F)



F039S Oak Premium White

Surface lacquered



F043S Oak Graphite Black

Surface lacquered



F058K Oak Silk Grey

Surface stained



F075S Oak schwarz

Surface lacquered



F076K Oak Macaron

Surface lacquered



F213K untreated oak

Surface stained



F214K coffee brown oak

Surface stained



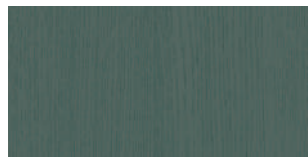
F218S Light Pepper oak

Surface lacquered



F230S oak Art Pepper

Surface lacquered



F245S oak Night Green

Surface lacquered



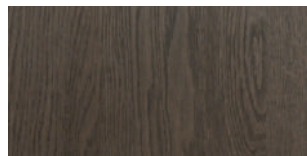
F248S Light Nude oak

Surface lacquered



F258K Gavi oak

Surface stained



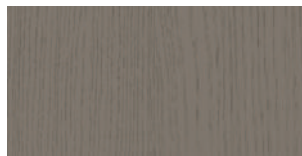
F259K dark oak

Surface stained



F261K Urban Oak

Surface stained



F263S Fango oak

Surface lacquered



F279K Moderno Rustico oak

Surface stained



Additional price for special paint per commission in microstructure/velvet varnish wood

MP-SOFA

Extra charge

628

F099K Special finish oak veneer

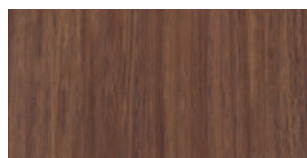
Surface lacquered

Units with roller shutter not available

Special paint finishes according to RAL, SIKKENS or COLOR NETWORK: Special finishes from the RALClassic, RAL-DESIGN, SIKKENS or COLOR NETWORK colour systems are available for an additional charge per order and colour.

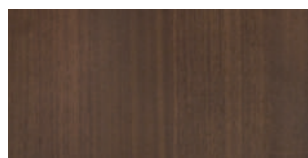
The surcharge is calculated from the first article, irrespective of the order volume. If several colours are required in one order, the surcharge must be taken into account for each colour.

Minor color deviations in subsequent deliveries cannot be ruled out. Older sample charts will change when exposed to light.



F257K Rosso walnut veneer

Surface stained



F231K Walnut Veneer

Surface veneered

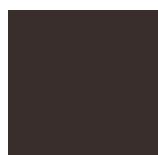
Containers not available  
Pilasters not available

## Available accessory elements (decor group F)

Carcasedecors	Visible sides	Plinth	background fillers	Recess back panel	Back cladding	Shelf units	Glass wall units (IDF...)	Container boxes	Panel decors 1.0 cm	Panel decors 1.6 cm	Panel decors 1.9 cm	Panel decors 2.5 cm	Panel decors 5 cm	Stiles 10 cm	pilasters	Cornice + light pelmet	Units with roller shutter
-	X	X	X	-	X	X	X	X	-	X	X	X	X	X	X	-	X

Visible sides one side in decor group F, one side in the standard carcasse decor from decor group K, front edge in colour tone decor group F

## Colour concept at no extra charge



Sealbrown  
RAL 8019



cristal red  
SIKKENS  
C0.60.30



Savona green  
SIKKENS  
K0.05.47



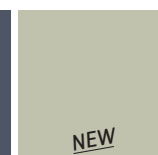
Victoria green  
RAL 180 30 10



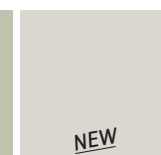
Night Red  
SIKKENS  
C0.20.20



Blackblue  
SIKKENS  
U0.10.20













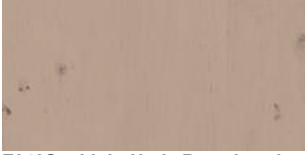

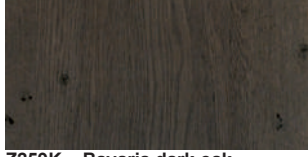
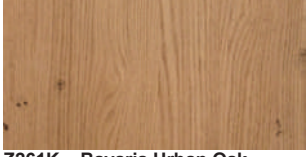

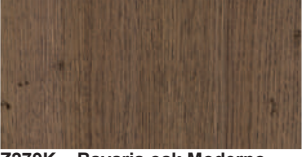
Jade, pastel  
RAL 7032



live simple!  
No. 8



# M 70 Veneer colours (decor group Z)

			
<b>Z039S</b> Bavaria oak premium white Surface lacquered	<b>Z043S</b> Bavaria oak graphite black Surface lacquered	<b>Z058K</b> Bavaria oak silky grey Surface stained	<b>Z075S</b> Bavaria oak black Surface lacquered
			
<b>Z076K</b> Bavaria oak Macaron Surface lacquered	<b>Z213K</b> Untreated Bavaria oak Surface stained	<b>Z214K</b> coffee brown Bavaria oak Surface stained	<b>Z218S</b> Bavaria oak Light Pepper Surface lacquered
			
<b>Z230S</b> Bavaria oak Art Pepper Surface lacquered	<b>Z245S</b> Bavaria oak Night Green Surface lacquered	<b>Z248S</b> Light Nude Bavaria oak Surface lacquered	<b>Z258K</b> Bavaria Gavi oak Surface stained
			
<b>Z259K</b> Bavaria dark oak Surface stained	<b>Z261K</b> Bavaria Urban Oak Surface stained	<b>Z263S</b> Fango Bavaria oak Surface lacquered	<b>Z279K</b> Bavaria oak Moderno Rustico Surface stained



Additional price for special paint per commission in microstructure/velvet varnish wood

MP-SOFA

Extra charge 628

Special paint finishes according to RAL, SIKKENS or COLOR NETWORK: Special finishes from the RALClassic, RAL-DESIGN, SIKKENS or COLOR NETWORK colour systems are available for an additional charge per order and colour. The surcharge is calculated from the first article, irrespective of the order volume. If several colours are required in one order, the surcharge must be taken into account for each colour.

Minor color deviations in subsequent deliveries cannot be ruled out. Older sample charts will change when exposed to light.

**Z099K** Bavaria oak veneer special lacquering  
Surface lacquered  
Units with roller shutter not available

## Available accessory elements (decor group Z)

Carcasdecor	Visible sides	Plinth	background fillers	Recess back panel	Back cladding	Shelf units	Glass wall units (DF..)	Container boxes	Panel decors 1.0 cm	Panel decors 1.6 cm	Panel decors 1.9 cm	Panel decors 2.5 cm	Panel decors 5 cm	Stiles 10 cm	pilasters	Cornice + light pelmet	Units with roller shutter
-	X	X	X	-	X	X	X	-	-	X	X	X	X	X	X	-	X

Visible sides one side in decor group Z, one side in the standard carcass decor from decor group K, front edge in colour tone decor group Z

## Colour concept at no extra charge

							
<b>Sealbrown</b> RAL 8019	<b>cristal red</b> SIKKENS C0.60.30	<b>Savona green</b> SIKKENS K0.05.47	<b>Victoria green</b> RAL 180 30 10	<b>Night Red</b> SIKKENS C0.20.20	<b>Blackblue</b> SIKKENS U0.10.20	<b>Jade, pastel</b> RAL 7032	<b>live simple!</b> No. 8

# M 70 Velvet lacquer textured (decor group V)



V195W Bronze Metallic

Surface Velvet lacquer textured



V246W Basalt Metallic

Surface Velvet lacquer textured



V182W Silver Metallic

Surface Velvet lacquer textured



V183W Gold Metallic

Surface Velvet lacquer textured



V194W Copper Metallic

Surface Velvet lacquer textured



V235W Titan Metallic

Surface Velvet lacquer textured

## Available accessory elements (decor group V)

Carcasdecor	Visible sides	Plinth	background fillers	Recess back panel	Back cladding	Shelf units	Glass wall units (IDF...)	Container boxes	Panel decors 1.0 cm	Panel decors 1.6 cm	Panel decors 1.9 cm	Panel decors 2.5 cm	Panel decors 5 cm	Stiles 10 cm	pilasters	Cornice + light pelmet	Units with roller shutter
-	X	X	-	-	-	-	-	-	-	X	-	-	-	X	-	-	-

## M 80 Veneer colours (decor group O)



O170S Antique Oak

Surface Veneer



O197S light Spessart oak

Surface Veneer



O215S larch veneer

Surface Veneer



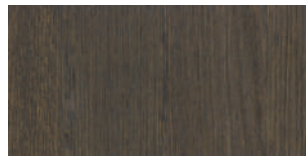
O232S Spessart-oak leached

Surface Veneer



O233S Spessart-oak Honey

Surface Veneer



O259K Dark oak stained

Surface Brushed veneer

## Available accessory elements (decor group O)

Carcasdecor	Visible sides	Plinth	background fillers	Recess back panel	Back cladding	Shelf units	Glass wall units (IDF...)	Container boxes	Panel decors 1.0 cm	Panel decors 1.6 cm	Panel decors 1.9 cm	Panel decors 2.5 cm	Panel decors 5 cm	Stiles 10 cm	pilasters	Cornice + light pelmet	Units with roller shutter
-	X	X	-	-	-	-	-	-	-	X	-	X	-	-	-	-	-

The interior sides of visible sides are matched in colour to the outer veneer

# M 80 High-gloss lacquer colours (decor group H)



H006H Light Grey

Surface High-gloss lacquer



H039H Premium white

Surface High-gloss lacquer



H043H Graphite Black

Surface High-gloss lacquer



H058H Magic-grey

Surface High-gloss lacquer



H075H Black

Surface High-gloss lacquer



H076H Macaron

Surface High-gloss lacquer



H160H Snow White

Surface High-gloss lacquer



H178H White Agate

Surface High-gloss lacquer



H218H Light Pepper

Surface High-gloss lacquer



H230H Art Pepper

Surface High-gloss lacquer



H245H Night Green

Surface High-gloss lacquer



H248H Light Nude

Surface High-gloss lacquer



H263H Fango

Surface High-gloss lacquer



H099H Special colours

Surface High-gloss lacquer

Additional price for special paint per commission in high-gloss lacquer

MP-SOFA-H

Extra charge 773

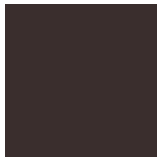
**Special lacquering in accordance with RAL, SIKKENS or COLOR NETWORK:**  
 Special lacquer finishes from the RAL Classic, RAL DESIGN, SIKKENS and COLOR NETWORK colour system are available at an extra charge in the same surface texture per order and colour.  
 The extra charge is calculated independently of the scope of the order, from the first article on units and accessory elements.  
 If several colours are desired in the same order, account is to be taken of the extra charge for each colour.  
 Minor color deviations in subsequent deliveries cannot be ruled out.  
 Older sample charts will change when exposed to light.

## Available accessory elements (decor group H)

Carcasdecor	Visible sides	Plinth	background fillers	Recess back panel	Back cladding	Shelf units	Glass wall units (DF...)	Container boxes	Panel decors 1.0 cm	Panel decors 1.6 cm	Panel decors 1.9 cm	Panel decors 2.5 cm	Panel decors 5 cm	Stiles 10 cm	pilasters	Cornice + light pelmet	Units with roller shutter
-	X	X	X	X	X	X	X	-	X	X	X	X	X	X	-	X	-

Visible sides one side in decor group H, one side in the standard carcass decor from decor group K, front edge in colour tone decor group H

## Colour concept at no extra charge



Sealbrown RAL 8019



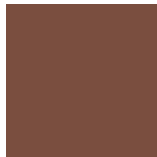
cristal red SIKKENS C0.60.30



Savona green SIKKENS K0.05.47



Victoria green RAL 180 30 10



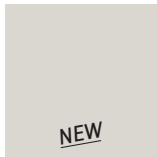
Night Red SIKKENS C0.20.20



Blackblue SIKKENS U0.10.20

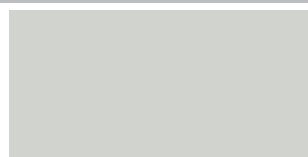


Jade, pastel RAL 7032



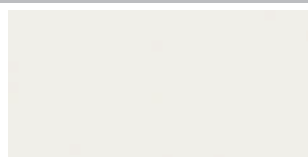
live simple! No. 8

# M 80 Matt lacquer Premium colours (decor group MP)



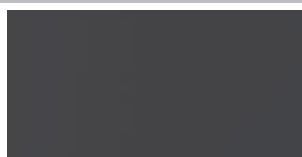
MP006 Light Grey

Surface Premium matt lacquer



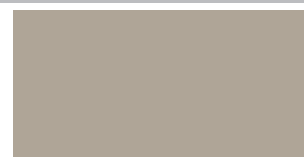
MP039 Premium white

Surface Premium matt lacquer



MP043 Graphite Black

Surface Premium matt lacquer



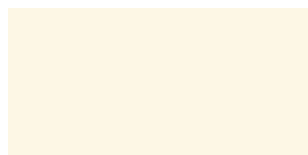
MP058 Magic-grey

Surface Premium matt lacquer



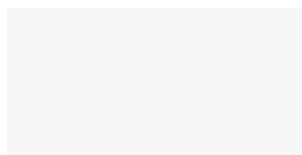
MP075 Black

Surface Premium matt lacquer



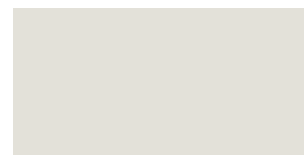
MP076 Macaron

Surface Premium matt lacquer



MP160 Snow White

Surface Premium matt lacquer



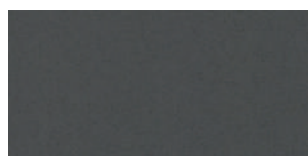
MP178 White Agate

Surface Premium matt lacquer



MP218 Light Pepper

Surface Premium matt lacquer



MP230 Art Pepper

Surface Premium matt lacquer



MP245 Night Green

Surface Premium matt lacquer



MP248 Light Nude

Surface Premium matt lacquer



MP263 Fango

Surface Premium matt lacquer



MP099 Special colours

Surface Premium matt lacquer

Additional price for special paint per commission in matt lacquer

MP-SOFA-M

Extra charge

773

Special lacquering in accordance with RAL, SIKKENS or COLOR NETWORK:

Special lacquer finishes from the RAL Classic, RAL DESIGN, SIKKENS and COLOR NETWORK colour system are available

at an extra charge in the same surface texture per order and colour.

The extra charge is calculated independently of the scope of the order, from the first article on units and accessory elements.

If several colours are desired in the same order, account is to be taken of the extra charge for each colour.

Minor color deviations in subsequent deliveries cannot be ruled out.

Older sample charts will change when exposed to light.

## Available accessory elements (decor group MP)

Carcasdecor	Visible sides	Plinth	background fillers	Recess back panel	Back cladding	Shelf units	Glass wall units (IDF...)	Container boxes	Panel decors 1.0 cm	Panel decors 1.6 cm	Panel decors 1.9 cm	Panel decors 2.5 cm	Panel decors 5 cm	Stiles 10 cm	pilasters	Cornice + light peimet	Units with roller shutter
-	X	X	X	X	X	X	X	-	X	X	X	X	X	X	-	X	-

Visible sides one side in decor group M, one side in the standard carcass decor from decor group K, front edge in colour tone decor group M

## Colour concept at no extra charge



Sealbrown  
RAL 8019



cristal red  
SIKKENS  
C0.60.30



Savona green  
SIKKENS  
K0.05.47



Victoria green  
RAL 180 30 10



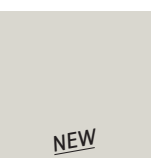
Night Red  
SIKKENS  
C0.20.20



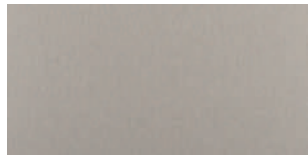
Blackblue  
SIKKENS  
U0.10.20



Jade, pastel  
RAL 7032



live simple!  
No. 8



C023M FENIX stainless steel look  
Surface super matt

## Available accessory elements (decor group C1)

Carcasdecor	Visible sides	Plinth	background fillers	Recess back panel	Back cladding	Shelf units	Glass wall units (IDF...)	Container boxes	Panel decors 1.0 cm	Panel decors 1.6 cm	Panel decors 1.9 cm	Panel decors 2.5 cm	Panel decors 5 cm	Stiles 10 cm	pilasters	Cornice + light pelmet	Units with roller shutter
-	X	X	X	X	X	-	-	-	-	X	-	-	-	X	-	-	-

## M 90 Worktop decors (decor group A116)



1200 Roxano volcano black



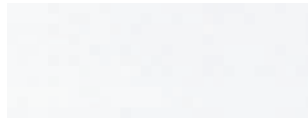
1210 Metal Rock anthracite



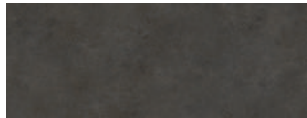
2032 Wild Oak Repro



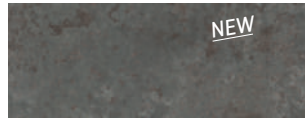
2260 Sand beige titanite



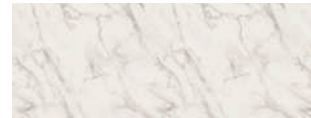
2701 snow white spatula look effect



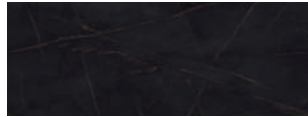
3797 Mocca



4268 natural Green Ceramic



8000 Crystal marble



9200 Cupria marble



9612 Graphite Black stone look

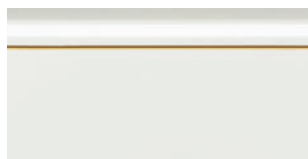


9630 Art Pepper stone look

## Available accessory elements (decor group A116)

Carcasdecor	Visible sides	Plinth	background fillers	Recess back panel	Back cladding	Shelf units	Glass wall units (IDF...)	Container boxes	Panel decors 1.0 cm	Panel decors 1.6 cm	Panel decors 1.9 cm	Panel decors 2.5 cm	Panel decors 5 cm	Stiles 10 cm	pilasters	Cornice + light pelmet	Units with roller shutter
-	-	-	-	X	-	-	-	-	-	X	-	-	-	-	-	-	-

## M 90 Special colours



U039M Premium white matt with gold-coloured applications

Decor group U available as  
Cornice + light pelmet  
Pilasters available

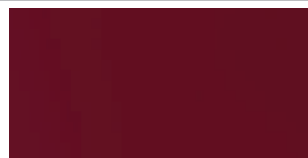
## Available accessory elements

Carcasdecor	Visible sides	Plinth	background fillers	Recess back panel	Back cladding	Shelf units	Glass wall units (IDF...)	Container boxes	Panel decors 1.0 cm	Panel decors 1.6 cm	Panel decors 1.9 cm	Panel decors 2.5 cm	Panel decors 5 cm	Stiles 10 cm	pilasters	Cornice + light pelmet	Units with roller shutter
-	-	-	-	-	-	-	-	-	-	-	-	-	-	-	X	X	-



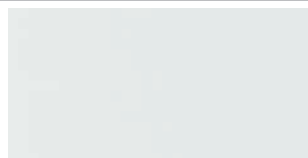
# M 90 Glass recess back panels

Note for colour numbers 82-990: substrate premium white, edge light grey, max. size 2500 x 1200 mm, minimum size 250 x 250 mm



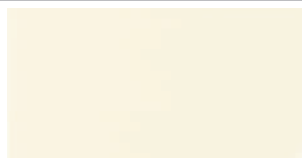
82 Red glass

Surface glass



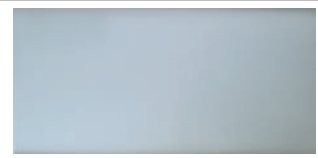
83 White glass

Surface glass



84 Macaron Glass

Surface glass



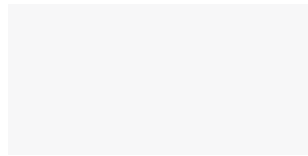
990 Grey glass

Surface glass



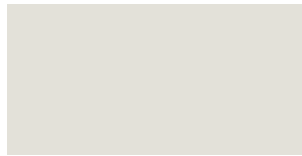
97 Black glass

Surface glass



960 Snow White Glass

Surface glass



921 White Agate glass

Surface glass

## Recess back panels, printed motif

Legend:

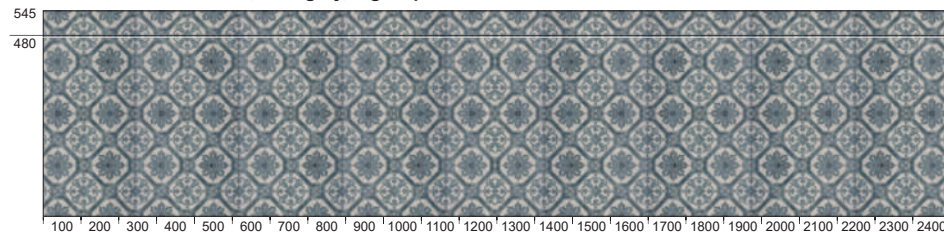
N1: Digital print on melamine resin-coated particle board

N2: Digital print behind glass

Decor groups

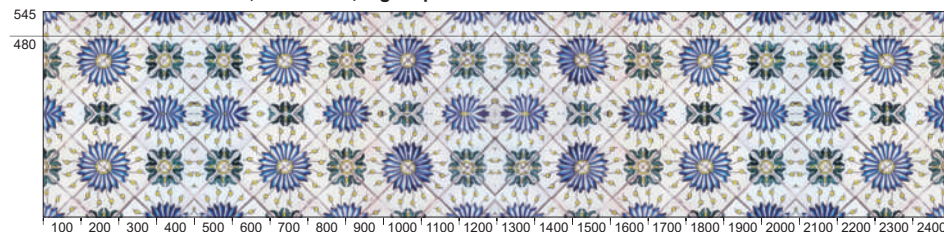
N1	N2
----	----

928 Tiles, blue-grey, digital print



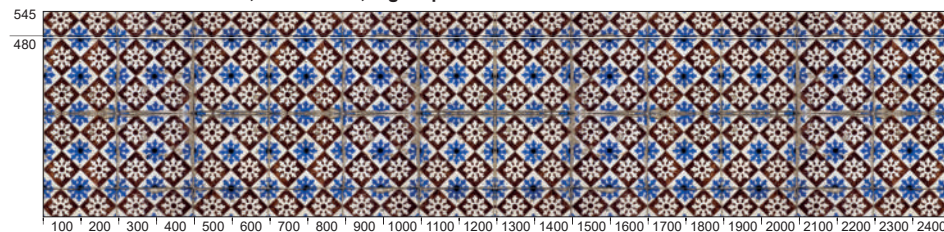
X	X	-
---	---	---

929 Tiles, blue-white, digital print



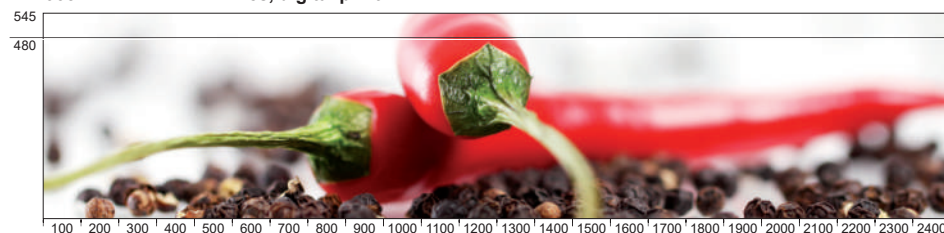
X	X	-
---	---	---

931 Tiles, brown-blue, digital print



X	X	-
---	---	---

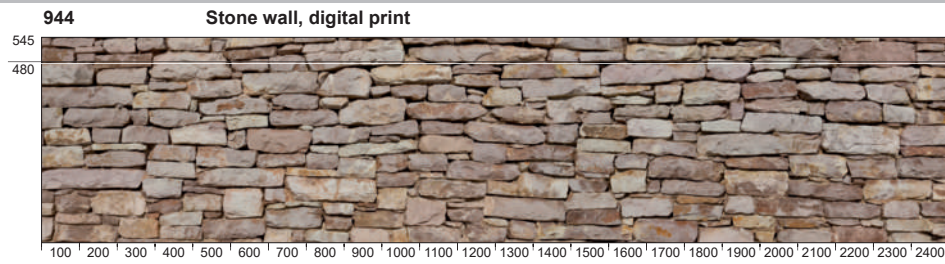
938 Chillies, digital print



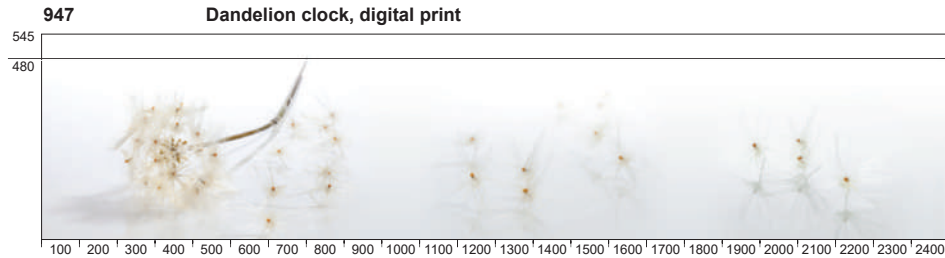
X	X	-
---	---	---

The respective image section is determined by the ordered length of the recess cladding and runs from left to right, extending the motif. Individual or deviating motif sections (including special heights up to 120 cm, for example) are possible via colour version 949 by prior arrangement.

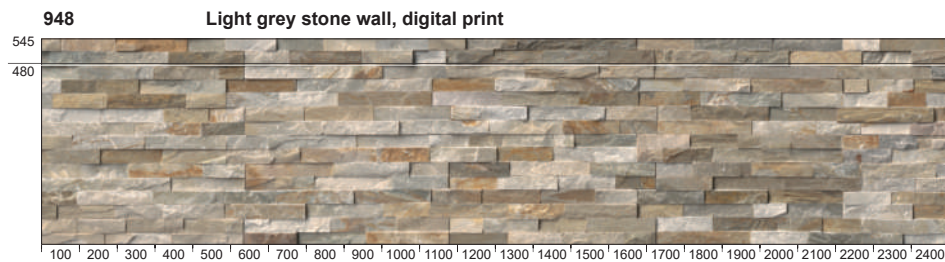
# Recess back panels, printed motif



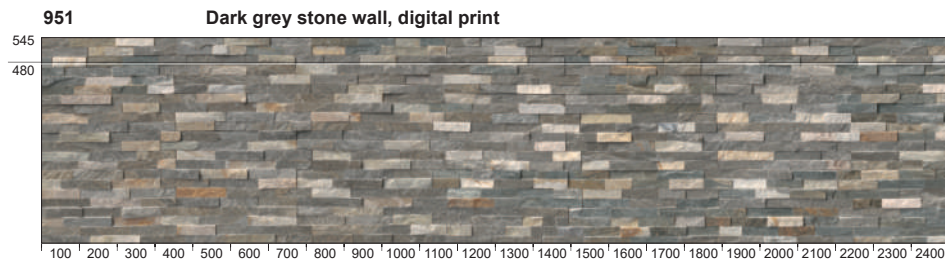
X	X	-
---	---	---



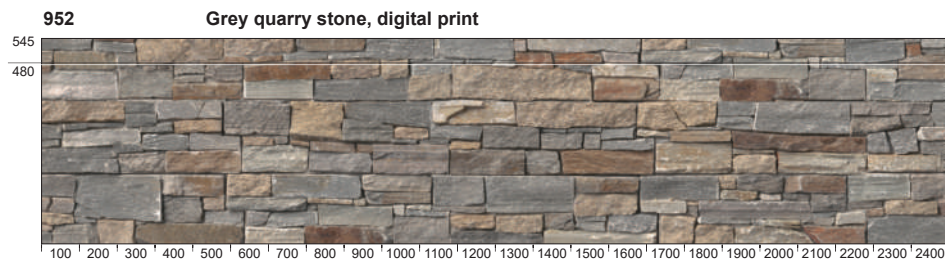
X	X	-
---	---	---



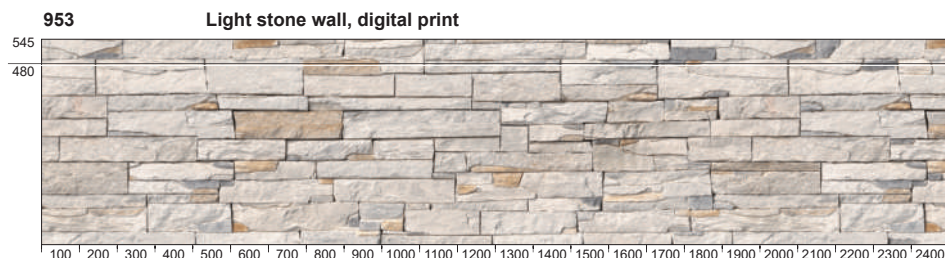
X	X	-
---	---	---



X	X	-
---	---	---



X	X	-
---	---	---



X	X	-
---	---	---

**949**

A recess back panel with the customer's own image file (no single colours, no Special colours such as RAL or SIKKENS) is also possible.  
 Note: If the image dimensions of the basic file do not correspond to the overall dimensions of the recess back panel, the height and width of the image file will be mirrored several times.  
 Image file specifications: high-resolution, jpg, EPS or TIF format.  
 Please order the version: 949 individual photograph





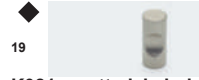





Examples of customer-specific images:

X	X	-
---	---	---



# Knobs




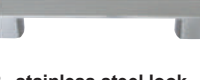
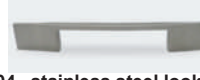

## Knobs

<p>◆</p> <p>23</p>  <p><b>K005</b> matt, gold-plated</p> <p>Unit price 14,10 Weight: 28 g</p>	<p>◆</p> <p>28</p>  <p><b>K051</b> Knob black antique</p> <p>Unit price 14,10 Weight: 55 g</p>	<p>◆</p> <p>30</p>  <p><b>K064</b> Knob black antique</p> <p>Unit price 14,10 Weight: 62 g</p>	<p>◆</p> <p>39</p>  <p><b>K077</b> Stainless steel</p> <p>Unit price 14,10 Weight: 73 g</p>	<p>◆</p> <p>19</p>  <p><b>K081</b> matt nickel-plated</p> <p>Unit price 14,10 Weight: 18 g</p>
<p>◆</p> <p>28</p>  <p><b>K090</b> Antique burnished</p> <p>Unit price 14,10 Weight: 95 g</p>	<p>◆</p> <p>28</p>  <p><b>K091</b> Knob black antique</p> <p>Unit price 14,10 Weight: 95 g</p>	<p>◆</p> <p>35</p>  <p><b>K141</b> tin-plated</p> <p>Unit price 14,10 Weight: 99 g</p>	<p>◆</p> <p>28</p>  <p><b>K191</b> black antique</p> <p>Unit price 14,10 Weight: 34 g</p>	<p>◆</p> <p>40</p>  <p><b>K199</b> rust brown antique</p> <p>Unit price 14,10 Weight: 60 g</p>

## Handles Drilling distance 64 / 96 mm

<p>◆</p> <p>30</p>  <p><b>G110</b> antique tin-plated Drilling distance 64 mm</p> <p>Unit price 14,10 Weight: 90 g</p>	<p>◆</p> <p>29</p>  <p><b>G093</b> black antique Drilling distance 96 mm</p> <p>Unit price 14,10 Weight: 83 g</p>
---	--

## Handles Drilling distance 128 mm

<p>◆</p> <p>35</p>  <p><b>G055</b> porcelain/burnished</p> <p>Unit price 14,10 Weight: 76 g</p>	<p>◆</p> <p>32</p>  <p><b>G058</b> cast iron black</p> <p>Unit price 14,10 Weight: 128 g</p>	<p>◆</p> <p>32</p>  <p><b>G073</b> iron antique</p> <p>Unit price 14,10 Weight: 100 g</p>	<p>◆</p> <p>29</p>  <p><b>G085</b> Brass matt</p> <p>Unit price 14,10 Weight: 103 g</p>	<p>◆</p> <p>29</p>  <p><b>G086</b> black matt</p> <p>Unit price 14,10 Weight: 103 g</p>
<p>◆</p> <p>27</p>  <p><b>G102</b> stainless steel look</p> <p>Unit price 14,10 Weight: 170 g</p>	<p>◆</p> <p>33</p>  <p><b>G104</b> stainless steel look</p> <p>Unit price 14,10 Weight: 153 g</p>	<p>◆</p> <p>31</p>  <p><b>G176</b> black antique</p> <p>Unit price 14,10 Weight: 194 g</p>		

## Handles Drilling distance 160 mm

<p>◆</p> <p>21</p>  <p><b>G002</b> stainless steel look</p> <p>Unit price 14,10 Weight: 153 g</p>	<p>◆</p> <p>30</p>  <p><b>G003</b> brass dark</p> <p>Unit price 14,10 Weight: 205 g</p>	<p>◆</p> <p>29</p>  <p><b>G004</b> stainless steel look</p> <p>Unit price 14,10 Weight: 162 g</p>	<p>◆</p> <p>25</p>  <p><b>G007</b> brass-coloured antique</p> <p>Unit price 14,10 Weight: 113 g</p>	<p>◆</p> <p>25</p>  <p><b>G008</b> copper-coloured antique</p> <p>Unit price 14,10 Weight: 113 g</p>
<p>◆</p> <p>30</p>  <p><b>G015</b> black</p> <p>Unit price 14,10 Weight: 123 g</p>	<p>◆</p> <p>30</p>  <p><b>G017</b> black</p> <p>Unit price 14,10 Weight: 201 g</p>	<p>◆</p> <p>39</p>  <p><b>G031</b> stainless steel look dark</p> <p>Unit price 14,10 Weight: 147 g</p>	<p>◆</p> <p>28</p>  <p><b>G032</b> matt nickel-plated</p> <p>Unit price 14,10 Weight: 106 g</p>	<p>◆</p> <p>36</p>  <p><b>G034</b> Stainless steel</p> <p>Unit price 14,10 Weight: 127 g</p>
<p>◆</p> <p>28</p>  <p><b>G042</b> stainless steel look dark</p> <p>Unit price 14,10 Weight: 122 g</p>	<p>◆</p> <p>36</p>  <p><b>G044</b> cast iron black antique</p> <p>Unit price 14,10 Weight: 156 g</p>	<p>◆</p> <p>32</p>  <p><b>G045</b> Stainless steel</p> <p>Unit price 14,10 Weight: 42 g</p>	<p>◆</p> <p>35</p>  <p><b>G046</b> Stainless steel</p> <p>Unit price 14,10 Weight: 131 g</p>	<p>◆</p> <p>38</p>  <p><b>G048</b> black</p> <p>Unit price 14,10 Weight: 171 g</p>
<p>◆</p> <p>34</p>  <p><b>G049</b> titanium</p> <p>Unit price 14,10 Weight: 130 g</p>	<p>◆</p> <p>27</p>  <p><b>G050</b> black antique</p> <p>Unit price 14,10 Weight: 124 g</p>	<p>◆</p> <p>38</p>  <p><b>G054</b> titanium</p> <p>Unit price 14,10 Weight: 171 g</p>	<p>◆</p> <p>30</p>  <p><b>G069</b> nickel plated</p> <p>Unit price 14,10 Weight: 186 g</p>	<p>◆</p> <p>31</p>  <p><b>G072</b> Titanium lacquered</p> <p>Unit price 14,10 Weight: 201 g</p>
<p>◆</p> <p>28</p>  <p><b>G165</b> black</p> <p>Unit price 14,10 Weight: 89 g</p>	<p>◆</p> <p>31</p>  <p><b>G078</b> matt, gold-plated</p> <p>Unit price 14,10 Weight: 201 g</p>	<p>◆</p> <p>35</p>  <p><b>G080</b> black matt</p> <p>Unit price 14,10 Weight: 190 g</p>	<p>◆</p> <p>34</p>  <p><b>G083</b> black matt</p> <p>Unit price 14,10 Weight: 212 g</p>	<p>◆</p> <p>34</p>  <p><b>G084</b> Titanium lacquered</p> <p>Unit price 14,10 Weight: 189 g</p>

◆ = handle height in mm

No credit is given for omitted handles and knobs.


# Handles Drilling distance 160 mm

 <b>G108 Bronze</b> Unit price 14,10 <small>NEW</small> Weight: 131 g	 <b>G089 matt nickel-plated</b> Unit price 14,10 Weight: 180 g	 <b>G092 brass-coloured</b> Unit price 14,10 Weight: 123 g	 <b>G097 black</b> Unit price 14,10 Weight: 113 g	 <b>G098 titanium</b> Unit price 14,10 Weight: 113 g
 <b>G099 black</b> Unit price 14,10 Weight: 76 g	 <b>G101 stainless steel look</b> Unit price 14,10 Weight: 131 g	 <b>G103 stainless steel look</b> Unit price 14,10 Weight: 135 g	 <b>G120 stainless steel look</b> Unit price 14,10 Weight: 112 g	 <b>G105 stainless steel look</b> Unit price 14,10 <small>NEW</small> Weight: 313 g
 <b>G123 stainless steel look</b> Unit price 14,10 Weight: 211 g	 <b>G130 stainless steel look</b> Unit price 14,10 Weight: 255 g	 <b>G143 stainless steel look</b> Unit price 14,10 Weight: 204 g	 <b>G164 zinc antique</b> Unit price 14,10 Weight: 126 g	 <b>G174 stainless steel look</b> Unit price 14,10 Weight: 192 g
 <b>G175 stainless steel look</b> Unit price 14,10 Weight: 89 g	 <b>G195 stainless steel look</b> Unit price 14,10 Weight: 120 g	 <b>G198 stainless steel look</b> Unit price 14,10 Weight: 153 g		

## Handles Drilling distance 192 mm

 <b>G082 Titanium lacquered</b> Unit price 14,10 Weight: 281 g	 <b>G096 black</b> Unit price 14,10 Weight: 281 g	 <b>G142 aluminium stainless steel look</b> Unit price 14,10 Weight: 126 g	 <b>G184 stainless steel look</b> Unit price 14,10 Weight: 285 g
---	---	--	---

## Handles Drilling distance 160 / 320 mm

 <b>G215 black</b> Unit price 14,10 Weight: 203 g	 <b>G220 stainless steel look</b> Unit price 14,10 Weight: 217 g	 <b>G205 stainless steel look</b> Unit price 14,10 <small>NEW</small> Weight: 217 g	 <b>G230 stainless steel look</b> Unit price 14,10 Weight: 443 g	 <b>G231 stainless steel look dark</b> Unit price 14,10 Weight: 181 g
 <b>G234 Stainless steel</b> Unit price 14,10 Weight: 223 g	 <b>G242 Stainless steel dark</b> Unit price 14,10 Weight: 176 g	 <b>G245 Stainless steel</b> Unit price 14,10 Weight: 77 g	 <b>G246 Stainless steel</b> Unit price 14,10 Weight: 227 g	 <b>G248 black</b> Unit price 14,10 Weight: 443 g
 <b>G254 titanium</b> Unit price 14,10 Weight: 443 g	 <b>G280 black matt</b> Unit price 14,10 Weight: 330 g	 <b>G292 brass-coloured</b> Unit price 14,10 Weight: 203 g	 <b>G295 stainless steel look</b> Unit price 14,10 Weight: 240 g	

### Note:

These combination handles are supplied with drilling distances of 160 mm and 320 mm.

#### Allocation with handle arrangement B:

Drilling distance 160 mm: Drawer panels, pull-out panels, flap doors up to 40 cm wide and doors 39 cm high

Drilling distance 320 mm: Drawer panels, pull-out panels, flap doors over 45 cm wide and doors over 52 cm high

#### Allocation with handle arrangement A and M:

Drilling distance 160 mm: Unit widths up to 40 cm

Drilling distance 320 mm: Unit widths over 45 cm

# Edge handle Drilling distance 128 mm



31



**G321 Aluminium handle black, brushed**

Weight: 66 g



**Planning advice**

With worktop depth 60 cm please pull forward base units and tall units by 2 cm - take account of worktop projection to carcass front edge!  
Distance to front edge 3 mm, drilling distance 11 mm to front edge, available from 20 cm unit width



**Available for:**

ARTE-B, ARTE-S, BAVARIA, CASA-B, EDITION, FENIX INOX, FLORENZ, GARDA, HPL PRO, INTAR-SIA, LUX-B, MALMÖ, MIAMI, MODENA, MONTANA, MUNICH, NEVADA, NEW OPAL-M, NOBEL-B, NOBEL-S, OPAL-H, PADUA, PALAZZO, PRIMEWOOD TOP, PUR, RESOPAL, RESOPAL PRO, RESOPAL PRO EDGE, RIVA, ROMA-B, ROMA-S, RUSTY OAK, SHERWOOD, SIGNUM-B, SMART, SMART MIRROR, SMART-M, TALEA, TIM, TOP, TREND

**Unit price** 14,10

## Edge handle Drilling distance 128/288 mm



31



**G371 Aluminium handle black, brushed**

Weight: 288 g



**Planning advice**

With worktop depth 60 cm please pull forward base units and tall units by 2 cm - take account of worktop projection to carcass front edge!  
Distance to front edge 3 mm, drilling distance 11 mm to front edge, available from 20 cm unit width

**Note:**

This combination handle is supplied with drilling distances of 128 mm and 288 mm.

**Allocation with handle arrangement M:**

Drilling distance 128 mm: Unit widths up to 40 cm  
Drilling distance 288 mm: Unit widths over 45 cm



**Available for:**

ARTE-B, ARTE-S, BAVARIA, CASA-B, EDITION, FENIX INOX, FLORENZ, GARDA, HPL PRO, INTAR-SIA, LUX-B, MALMÖ, MIAMI, MODENA, MONTANA, MUNICH, NEVADA, NEW OPAL-M, NOBEL-B, NOBEL-S, OPAL-H, PADUA, PALAZZO, PRIMEWOOD TOP, PUR, RESOPAL, RESOPAL PRO, RESOPAL PRO EDGE, RIVA, ROMA-B, ROMA-S, RUSTY OAK, SHERWOOD, SIGNUM-B, SMART, SMART MIRROR, SMART-M, TALEA, TIM, TOP, TREND

**Unit price** 14,10

## Handles Drilling distance 16 mm



28

**NEW**



**G024 black**

Weight: 60 g



not permitted for designer glass fronts  
not permitted for frame fronts with 75 mm frames  
not permitted for frame fronts with 80 mm frames  
only permitted in handle positions A and M



**Not available for:**

ATLANTA-B, ATLANTA-S, CASTELLO, CHALET-B, CHALET-S, CHICAGO, FRAME, LUX-B, NOBEL-B, NOBEL-S, ORLANDO-B, ORLANDO-S, PALERMO-B, PALERMO-S, ROMA-B, ROMA-S, SOFIE-B, SOFIE-S, VINO, VIVA, YORK-B, YORK-S

**Unit price** 14,10

# Drilling distance 128 mm

## Drilling distance 128 mm



32

G094 black antique

Unit price 20,80

Extra charge 6,70

Weight: 186 g



32

G095 Antique burnished

Unit price 20,80

Extra charge 6,70

Weight: 186 g

## Drilling distance 160 mm



25

G033 aluminium black, brushed  
Handle length: 180 mm  
Drilling distance 160 mm

Unit price 34

Extra charge 19,40

Weight: 74 g

G 063

Note for handle arrangement M:  
possible from 40 cm unit width

## Drilling distance 160 / 320 mm



36

G274 stainless steel look

Unit price 34

Extra charge 19,40

Weight: 327 g



34

G249 titanium

Unit price 20,80

Extra charge 6,70

Weight: 210 g



34

G283 black matt

Unit price 34

Extra charge 19,40

Weight: 342 g



34

G284 Titanium lacquered

Unit price 34

Extra charge 19,40

Weight: 342 g



35

G208 Bronze

Unit price 34

Extra charge 19,40

Weight: 443 g



32

G299 black

Unit price 28,30

Extra charge 14,20

Weight: 183 g

Note:

These combination handles are supplied with drilling distances of 160 mm and 320 mm.

**Allocation with handle arrangement B:**

Drilling distance 160 mm: Drawer panels, pull-out panels, flap doors up to 40 cm wide and doors 39 cm high

Drilling distance 320 mm: Drawer panels, pull-out panels, flap doors over 45 cm wide and doors over 52 cm high

**Allocation with handle arrangement A and M:**

Drilling distance 160 mm: Unit widths up to 40 cm

Drilling distance 320 mm: Unit widths over 45 cm

## Drilling distance 480 mm



32

G390 design handle black, brushed



Minimum width 60 cm and minimum height 65 cm  
Handle length 540 mm

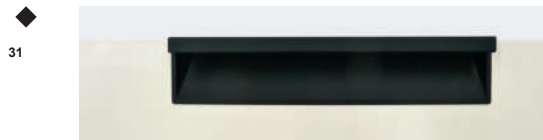
Opening angle limiters are absolutely necessary for doors and handle position M!

Unit price 34

Extra charge

19,40

# Shell handle



**M330** Shell handle black, brushed milled on the front edge



Possible for items with door dimensions from 296 mm! No driver for interior drawers possible (MIS-LB)



**Available for:**  
ARTE-B, ARTE-S, CASA-B, EDITION, FENIX INOX, GARDA, HPL PRO, MIAMI, NEW OPAL-M, OPAL-H, PALAZZO, PRIMEWOOD TOP, PUR, RESOPAL, RESOPAL PRO, RESOPAL PRO EDGE, RIVA, SHERWOOD, SIGNUM-B, SMART, SMART MIRROR, SMART-M, TOP, TREND

Unit price	45	Extra charge	31
------------	----	--------------	----



**M340** Shell handle black, brushed milled flat



Possible for items with door dimensions from 296 mm!

**Not available for:**  
Standard units with one drawer at the very bottom (above the bottom shelf)



**Available for:**  
ARTE-B, ARTE-S, CASA-B, EDITION, FENIX INOX, GARDA, HPL PRO, MIAMI, MPX, NEW OPAL-M, OPAL-H, PALAZZO, PRIMEWOOD TOP, PUR, RESOPAL, RESOPAL PRO, RESOPAL PRO EDGE, RIVA, SHERWOOD, SIGNUM-B, SMART, SMART MIRROR, SMART-M, TOP, TREND

Unit price	45	Extra charge	31
------------	----	--------------	----

## Handle for tall unit doors, suitable for grip ledges



**G169** aluminium stainless steel look  
Handle length: 446.5 mm

Weight: 182 g



**Handle for tall unit doors, suitable for grip ledges**

N 400/475/485, N 700/N 775, N 900/N 975

**Planning advice for handle G169 / G033:**

On tall units where the fronts are such that the handle position of grip ledges are such that the handle position of grip ledges

is ergonomically unfavourable, handle handle G 169/G 033 will be delivered for on-site assembly without additional charge. This concerns the following XL tall units with tall unit fronts in heights 129.6 cm and 142.6 cm with a pull-out of 25.6 or 38.6 cm height at the bottom.

For special orders, the handle can be included with the order for an additional charge.

Unit price	45	Extra charge	31
------------	----	--------------	----



**G033** aluminium black, brushed  
Handle length: 180 mm  
Drilling distance 160 mm

Weight: 74 g



**Handle for tall unit doors, suitable for grip ledges**

N 475 and N 775

**Planning advice for handle G169 / G033:**

On tall units where the fronts are such that the handle position of grip ledges are such that the handle position of grip ledges

is ergonomically unfavourable, handle handle G 169/G 033 will be delivered for on-site assembly without additional charge. This concerns the following XL tall units with tall unit fronts in heights 129.6 cm and 142.6 cm with a pull-out of 25.6 or 38.6 cm height at the bottom.

For special orders, the handle can be included with the order for an additional charge.

Unit price	34	Extra charge	19,40
------------	----	--------------	-------

## Handle for tall unit doors, suitable for grip ledges



**G179** handle for refrigerator doors  
Stainless steel look  
Drilling distance: 20 mm

Unit price 14,10



# Bar handle

◆

35



**S290 Bar handle black**  
Material:

Weight:

Front heights	Bar handle length	Drilling distance	Weight
386	222	130	130
516	352	150	150
581	417	150	150
646	482	160	160
711	547	170	170
776	612	190	190
841	677	200	200
906	742	210	210
1036	872	230	230
1166	1002	330	330
1296	1132	350	350
1426	1262	370	370



**Bar handle position with handle arrangement B:**

horizontal: Drawer panels, pull-out panels and flap doors

vertical: Doors

**Bar handle position with handle arrangement M:**

Arrangement generally horizontal

Exceptions: Unit models up to 30 cm width (vertical arrangement)

The bar handle in the next size down will be supplied for units of reduced width.

Above a total length of 1002 mm the handle has a 3x mount

Unit price 45 | Extra charge 31

Front widths	Handle length	Drilling distance	Weight
296	132	120	110
396	232	220	130
446	282	270	140
496	332	320	157
596	432	420	150
796	632	620	190
896	732	720	210
996	832	820	230
1196	1032	1020	330

◆

36



**S096 Bar handle thickness: 14 mm**  
Material handle bar: stainless steel, solid (DIN 4305)

Weight:

Front heights	Handle length	Drilling distance	Weight
386	249	210	365
516	379	340	525
581	444	405	603
646	509	470	682
711	574	535	761
776	639	600	841
841	704	665	915
906	769	730	998
1036	899	860	1156
1166	1029	990	1345
1296	1159	1120	1504
1426	1289	1250	1662



**Bar handle position with handle arrangement B:**

horizontal: Drawer panels, pull-out panels and flap doors

vertical: Doors

**Bar handle position with handle arrangement M:**

Arrangement generally horizontal

Exceptions: Unit models up to 30 cm width (vertical arrangement)

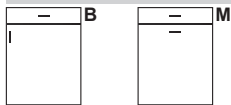
The bar handle in the next size down will be supplied for units of reduced width.

Note: Please mount bar handle foot flush on the outside

Unit price 45 | Extra charge 31

Front widths	Handle length	Drilling distance	Weight
296	159	120	257
396	259	220	379
446	309	270	440
496	359	320	500
596	459	420	622
796	659	620	865
896	759	720	986
996	859	820	1108
1196	1059	1020	1382

Available handle arrangements



## Special handles

◆

45



**G023 handle Grip-around handle for refrigerator doors**  
Stainless steel look

Unit price 17,30

Weight: 71 g

◆

30



**G029 handle Screw on handle for the interior side of folding flap door units and retractable doors**  
Stainless steel look

Unit price 17,30

Weight: 51 g

# Grip ledge N 700 / N 775



**N700** Grip ledge (top-mounted) aluminium inox



1. Compensation panels, fronts for integrated dishwashers are supplied without grip ledge. Fronts with top-mounted drawer panels (joined) are supplied pinned.
  2. Grip ledges are not available in conjunction with units of reduced width, sink base units with joined panels or inside panels. Glass doors are also not available.
  3. With worktop depth 60 cm please pull forward base units and tall units by 2 cm - take account of worktop projection to carcass front edge!
- No driver for interior drawers possible (MIS-LB)



**Available for:**  
EDITION, FENIX INOX, GARDA, PRIMEWOOD TOP, PUR, RESOPAL, RESOPAL PRO, RESOPAL PRO EDGE, RIVA, SHERWOOD, TOP, TREND

<b>Unit price</b>	45	<b>Extra charge</b>	31
-------------------	----	---------------------	----



**N775** Grip ledge (top-mounted) black



1. Compensation panels, fronts for integrated dishwashers are supplied without grip ledge. Fronts with top-mounted drawer panels (joined) are supplied pinned.
2. Grip ledges are not available in conjunction with units of reduced width, sink base units with joined panels or inside panels. Glass doors are also not available.
3. With worktop depth 60 cm please pull forward base units and tall units by 2 cm - take account of worktop projection to carcass front edge! No driver for interior drawers possible (MIS-LB)

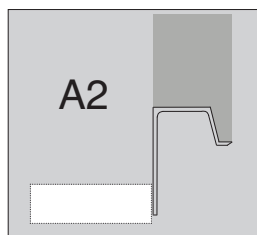
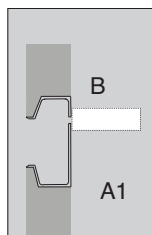
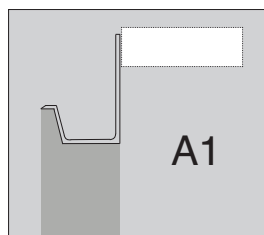
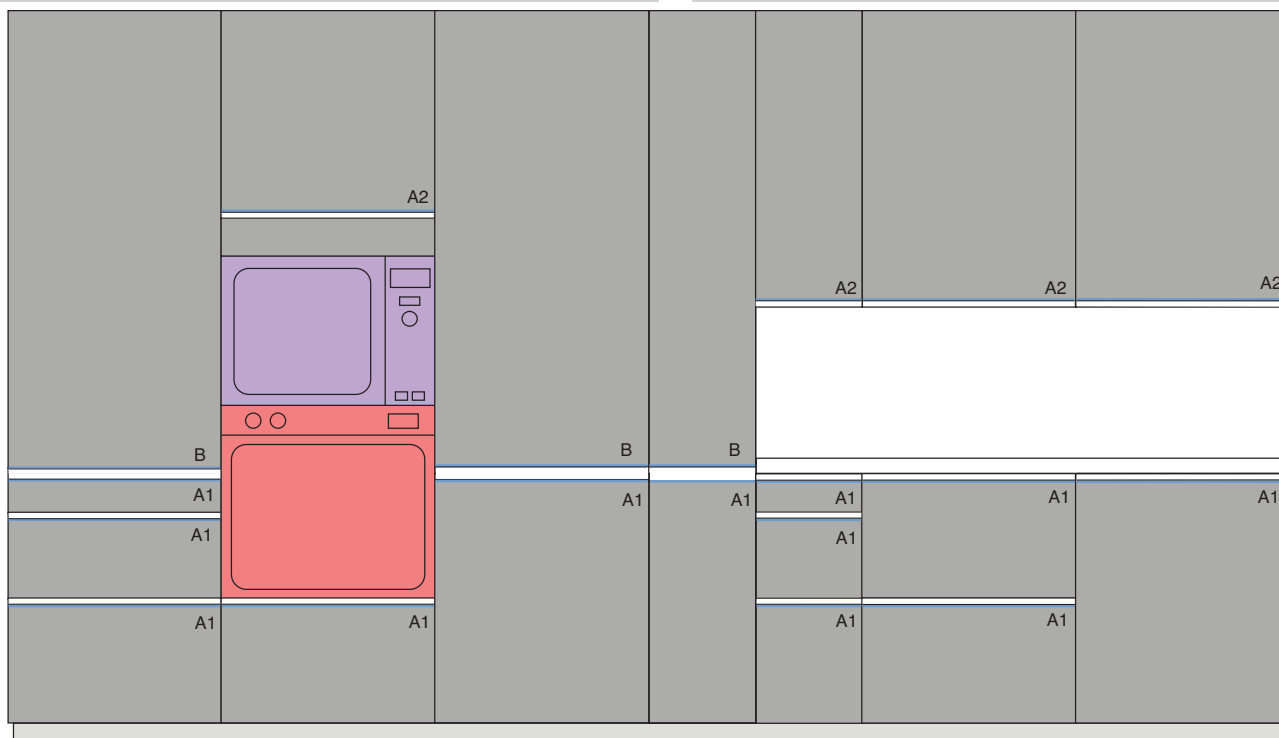


**Available for:**  
EDITION, FENIX INOX, GARDA, PRIMEWOOD TOP, PUR, RESOPAL, RESOPAL PRO, RESOPAL PRO EDGE, RIVA, SHERWOOD, TOP, TREND

<b>Unit price</b>	45	<b>Extra charge</b>	31
-------------------	----	---------------------	----

Front width	Handle length	Weight
146	146,5	47
196	196,5	63
246	246,5	79
296	296,5	95
396	396,5	127
446	446,5	143
496	496,5	159

Front width	Handle length	Weight
596	596,5	160
696	696,5	217
796	796,5	255
896	896,5	287
996	996,5	319
1196	1196,5	383





# Grip ledge N 400 / N 475 / N 485



**N400** Grip ledge (top-mounted)  
aluminium stainless steel look

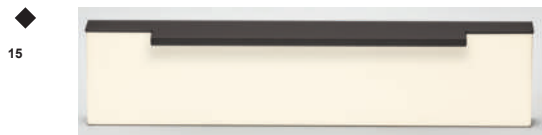


1. Fillers and corner fillers, compensation panels, fixed panels and fronts for integrated dishwashers are supplied without grip ledges N 400/N475. Fronts with top-mounted drawer panels (joined) are supplied pinned.
2. Grip ledges N 400/N 475/N 485 are not available for glass doors (exception: segment glass doors)
3. Grip ledges N 400/N 475/N 485 are not available in conjunction with units of reduced width.



**Available for:**  
ARTE-B, ARTE-S, BAVARIA, CASA-B, EDITION, FENIX INOX, FLORENZ, GARDA, HPL PRO, INTAR-SIA, MALMÖ, MIAMI, MODENA, MONTANA, MUNICH, NEVADA, NEW OPAL-M, OPAL-H, PADUA, PALERMO-B, PALERMO-S, PRIMEWOOD TOP, PUR, RESOPAL, RESOPAL PRO, RESOPAL PRO EDGE, RIVA, ROMA-B, ROMA-S, RUSTY OAK, SHERWOOD, SIGNUM-B, SMART, SMART MIRROR, SMART-M, TALEA, TIM, TIM 15, TOP, TREND, VILLAGE 15-B, VILLAGE 15-S

<b>Unit price</b>	45	<b>Extra charge</b>	31
-------------------	----	---------------------	----



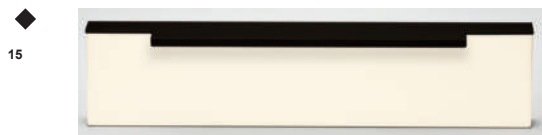
**N485** Grip ledge (top-mounted)  
titanium



1. Fillers and corner fillers, compensation panels, fixed panels and fronts for integrated dishwashers are supplied without grip ledges N 400/N475. Fronts with top-mounted drawer panels (joined) are supplied pinned.
2. Grip ledges N 400/N 475/N 485 are not available for glass doors (exception: segment glass doors)
3. Grip ledges N 400/N 475/N 485 are not available in conjunction with units of reduced width.

**Available for:**  
ARTE-B, ARTE-S, BAVARIA, CASA-B, EDITION, FENIX INOX, FLORENZ, GARDA, HPL PRO, INTAR-SIA, MALMÖ, MIAMI, MODENA, MONTANA, MUNICH, NEVADA, NEW OPAL-M, OPAL-H, PADUA, PALERMO-B, PALERMO-S, PRIMEWOOD TOP, PUR, RESOPAL, RESOPAL PRO, RESOPAL PRO EDGE, RIVA, ROMA-B, ROMA-S, RUSTY OAK, SHERWOOD, SIGNUM-B, SMART, SMART MIRROR, SMART-M, TALEA, TIM, TIM 15, TOP, TREND, VILLAGE 15-B, VILLAGE 15-S

<b>Unit price</b>	45	<b>Extra charge</b>	31
-------------------	----	---------------------	----



**N475** Grip ledge (top-mounted)  
aluminium black, brushed



1. Fillers and corner fillers, compensation panels, fixed panels and fronts for integrated dishwashers are supplied without grip ledges N 400/N475. Fronts with top-mounted drawer panels (joined) are supplied pinned.
2. Grip ledges N 400/N 475/N 485 are not available for glass doors (exception: segment glass doors)
3. Grip ledges N 400/N 475/N 485 are not available in conjunction with units of reduced width.



**Available for:**  
ARTE-B, ARTE-S, BAVARIA, CASA-B, EDITION, FENIX INOX, FLORENZ, GARDA, HPL PRO, INTAR-SIA, MALMÖ, MIAMI, MODENA, MONTANA, MUNICH, NEVADA, NEW OPAL-M, OPAL-H, PADUA, PALERMO-B, PALERMO-S, PRIMEWOOD TOP, PUR, RESOPAL, RESOPAL PRO, RESOPAL PRO EDGE, RIVA, ROMA-B, ROMA-S, RUSTY OAK, SHERWOOD, SIGNUM-B, SMART, SMART MIRROR, SMART-M, TALEA, TIM, TIM 15, TOP, TREND, VILLAGE 15-B, VILLAGE 15-S

<b>Unit price</b>	45	<b>Extra charge</b>	31
-------------------	----	---------------------	----

Front width	Handle length	protruding handle area	Weight	Front width	Handle length	protruding handle area	Weight
146	146.5	47	59	596	596.5	447	240
196	196.5	47	79	696	696.5	547	261
246	246.5	97	99	746	746.5	597	282
296	296.5	147	120	796	796.5	647	320
396	396.5	247	160	896	896.5	747	361
446	446.5	297	180	996	996.5	847	401
496	496.5	347	200	1196	1196.5	1047	480

# Grip ledge N 900 / N 975



**N900** Grip ledge (top-mounted)  
aluminium stainless steel look



1. Fillers and corner fillers, compensation panels, fixed panels and fronts for integrated dishwashers are supplied without grip ledges N 900/N975. Fronts with top-mounted drawer panels (joined) are supplied pinned.
2. Grip ledges N 900/N 975 are not available for glass doors (exception: segment glass doors)
3. Grip ledges N 900/N 975 are not available in conjunction with units of reduced width.



**Available for:**

ARTE-B, ARTE-S, BAVARIA, CASA-B, EDITION, FENIX INOX, FLORENZ, GARDA, GENT, HPL PRO, INTARSIA, MALMÖ, MIAMI, MODENA, MONTANA, MUNICH, NEVADA, NEW OPAL-M, OPAL-H, PADUA, PALAZZO, PALERMO-B, PALERMO-S, PRIMEWOOD TOP, PUR, RESOPAL, RESOPAL PRO, RESOPAL PRO EDGE, RIVA, ROMA-B, ROMA-S, RUSTY OAK, SHERWOOD, SIGNUM-B, SMART, SMART MIRROR, SMART-M, TALEA, TIM, TIM 15, TOP, TREND, VILLAGE 15-B, VILLAGE 15-S

<b>Unit price</b>	45	<b>Extra charge</b>	31
-------------------	----	---------------------	----



**N975** Grip ledge (top-mounted)  
aluminium black, brushed



1. Fillers and corner fillers, compensation panels, fixed panels and fronts for integrated dishwashers are supplied without grip ledges N 900/N975. Fronts with top-mounted drawer panels (joined) are supplied pinned.
2. Grip ledges N 900/N 975 are not available for glass doors (exception: segment glass doors)
3. Grip ledges N 900/N 975 are not available in conjunction with units of reduced width.



**Available for:**

ARTE-B, ARTE-S, BAVARIA, CASA-B, EDITION, FENIX INOX, FLORENZ, GARDA, GENT, HPL PRO, INTARSIA, MALMÖ, MIAMI, MODENA, MONTANA, MUNICH, NEVADA, NEW OPAL-M, OPAL-H, PADUA, PALAZZO, PALERMO-B, PALERMO-S, PRIMEWOOD TOP, PUR, RESOPAL, RESOPAL PRO, RESOPAL PRO EDGE, RIVA, ROMA-B, ROMA-S, RUSTY OAK, SHERWOOD, SIGNUM-B, SMART, SMART MIRROR, SMART-M, TALEA, TIM, TIM 15, TOP, TREND, VILLAGE 15-B, VILLAGE 15-S

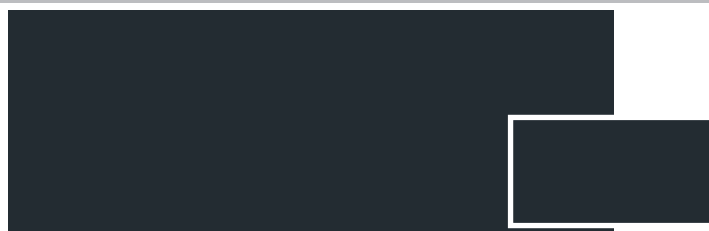
<b>Unit price</b>	45	<b>Extra charge</b>	31
-------------------	----	---------------------	----

Front width	Handle length	Weight	Front width	Handle length	Weight
146	146.5	47	596	596.5	224
196	196.5	68	696	696.5	268
246	246.5	73	746	746.5	290
296	296.5	94	796	796.5	311
396	396.5	138	896	896.5	355
446	446.5	159	996	996.5	398
496	496.5	181	1196	1196.5	485

# Model/handle arrangement overview

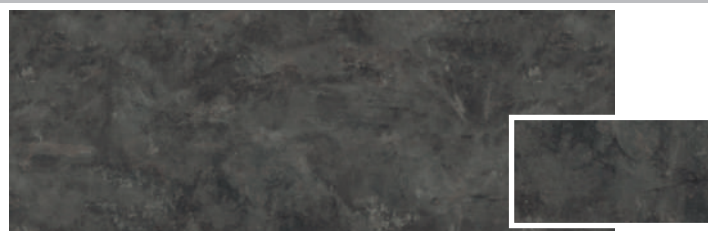
Drilling distance	Knobs	64/96 mm	128 mm	160 mm	192 mm	160/320 mm 192/256 mm	480 mm	Bar handles grip ledge / edge grips	Shell handle	16 mm										
<b>Knob/handle no.</b>	K 005 K 051 K 064 K 077 K 081 K 090 K 091 K 141 K 191	K 199 G 093 G 110	G 055 G 058 G 073 G 094 G 095 G 102 G 104 G 176	G 085 G 086	G 002 G 083 G 003 G 084 G 004 G 092 G 007 G 097 G 008 G 098 G 015 G 099 G 017 G 101 G 031 G 103 G 032 G 105 G 034 G 108 G 044 G 120 G 045 G 123 G 046 G 130 G 048 G 143 G 050 G 165 G 054 G 174 G 072 G 175 G 078 G 195 G 080 G 198	G 033 G 042 G 049 G 069 G 089 G 164	G 082 G 096 G 184	G 142	G 205 G 215 G 220 G 230 G 231 G 234 G 245 G 246 G 248 G 254 G 274 G 292 G 295 G 299	G 208 G 249 G 280 G 283 G 284	G 242	G 390	S 096 S 290	G 321 G 371	N 4... N 9...	N 7...	M 330	M 340	G024	
<b>PG1</b>																				
TOP		C/D	C/D	A/M	A/B/M	A/B/M	A/B/M	A/B/M	A/B/M	A/B/M	A/B/M	B/M	B/M	M	M	M	M	M	A/M	
TREND		C/D	C/D	A/M	A/B/M	A/B/M	A/B/M	A/B/M	A/B/M	A/B/M	A/B/M	B/M	B/M	M	M	M	M	M	A/M	
<b>PG2</b>																				
PUR		C/D	C/D	A/M	A/B/M	A/B/M	A/B/M	A/B/M	A/B/M	A/B/M	A/B/M	B/M	B/M	M	M	M	M	M	A/M	
EDITION		C/D	C/D	A/M	A/B/M	A/B/M	A/B/M	A/B/M	A/B/M	A/B/M	A/B/M	B/M	B/M	M	M	M	M	M	A/M	
<b>PG3</b>																				
RIVA / GARDA		C/D	C/D	A/M	A/B/M	A/B/M	A/B/M	A/B/M	A/B/M	A/B/M	A/B/M	B/M	B/M	M	M	M	M	M	A/M	
SHERWOOD		C/D	C/D	A/M	A/B/M	A/B/M	A/B/M	A/B/M	A/B/M	A/B/M	A/B/M	B/M	B/M	M	M	M	M	M	A/M	
CASA		C/D	C/D	A/M	A/B/M	A/B/M	A/B/M	A/B/M	A/B/M	A/B/M	A/B/M	B/M	B/M	M	M	-	M	M	A/M	
MIAMI		C/D	C/D	A/M	A/B/M	A/B/M	A/B/M	A/B/M	A/B/M	A/B/M	A/B/M	B/M	B/M	M	M	-	M	M	A/M	
SIGNUM		C/D	C/D	A/M	A/B/M	A/B/M	A/B/M	A/B/M	A/B/M	A/B/M	A/B/M	B/M	B/M	M	M	-	M	M	A/M	
RESOPAL		C/D	C/D	A/M	A/B/M	A/B/M	A/B/M	A/B/M	A/B/M	A/B/M	A/B/M	B/M	B/M	M	M	M	M	M	A/M	
RESOPAL PRO		C/D	C/D	A/M	A/B/M	A/B/M	A/B/M	A/B/M	A/B/M	A/B/M	A/B/M	B/M	B/M	M	M	M	M	M	A/M	
RESOPAL PRO EDGE		C/D	C/D	A/M	A/B/M	A/B/M	A/B/M	A/B/M	A/B/M	A/B/M	A/B/M	B/M	B/M	M	M	M	M	M	A/M	
ARTE		C/D	C/D	A/M	A/B/M	A/B/M	A/B/M	A/B/M	A/B/M	A/B/M	A/B/M	B/M	B/M	M	M	-	M	M	A/M	
FRAME		C/D	C/D	A/M	A/B/M	A/B/M	A/B/M	A/B/M	A/B/M	A/B/M	A/B/M	B/M	B/M	-	-	-	-	-	-	
PALERMO		C/D	C/D	A/M	A/B/M	A/B/M	A/B/M	A/B/M	A/B/M	A/B/M	A/B/M	B/M	B/M	-	M	-	-	-	-	
ROMA		C/D	C/D	A/M	A/B/M	A/B/M	A/B/M	A/B/M	A/B/M	A/B/M	A/B/M	B/M	B/M	M	M	-	-	-	-	
VIVA		C/D	C/D	A/M	A/B/M	A/B/M	A/B/M	A/B/M	A/B/M	A/B/M	A/B/M	B/M	B/M	-	-	-	-	-	-	
HPL PRO		C/D	C/D	A/M	A/B/M	A/B/M	A/B/M	A/B/M	A/B/M	A/B/M	A/B/M	B/M	B/M	M	M	M	M	M	A/M	
PRIMEWOOD TOP		C/D	C/D	A/M	A/B/M	A/B/M	A/B/M	A/B/M	A/B/M	A/B/M	A/B/M	B/M	B/M	M	M	-	-	M	A/M	
GENT		C/D	C/D	A/M	A/B/M	A/B/M	A/B/M	A/B/M	A/B/M	A/B/M	A/B/M	B/M	B/M	-	M	-	-	-	A/M	
<b>PG4</b>																				
SMART / SMART-M		C/D	C/D	A/M	A/B/M	A/B/M	A/B/M	A/B/M	A/B/M	A/B/M	A/B/M	B/M	B/M	M	M	-	M	M	A/M	
VILLAGE 15		C/D	C/D	-	A/B/M	A/B/M	A/B/M	A/B/M	A/B/M	A/B/M	A/B/M	B/M	B/M	-	M	-	-	-	A/M	
NOBEL		C/D	C/D	A/M	A/B/M	A/B/M	A/B/M	A/B/M	A/B/M	A/B/M	A/B/M	B/M	B/M	-	-	-	-	-	-	
LUX		C/D	C/D	A/M	A/B/M	A/B/M	A/B/M	A/B/M	A/B/M	A/B/M	A/B/M	B/M	B/M	-	-	-	-	-	-	
SOFIE		C/D	C/D	A/M	A/B/M	A/B/M	A/B/M	A/B/M	A/B/M	A/B/M	A/B/M	B/M	B/M	-	-	-	-	-	-	
PALAZZO		C/D	C/D	A/M	A/B/M	A/B/M	A/B/M	A/B/M	A/B/M	A/B/M	A/B/M	B/M	B/M	M	M	-	M	M	A/M	
<b>PG5</b>																				
FENIX-INOX		C/D	C/D	A/M	A/B/M	A/B/M	A/B/M	A/B/M	A/B/M	A/B/M	A/B/M	B/M	B/M	M	M	M	M	M		
YORK		C/D	C/D	A/M	A/B/M	A/B/M	A/B/M	A/B/M	A/B/M	A/B/M	A/B/M	B/M	B/M	-	-	-	-	-	-	
CHALET		C/D	C/D	A/M	A/B/M	A/B/M	A/B/M	A/B/M	A/B/M	A/B/M	A/B/M	B/M	B/M	-	-	-	-	-	-	
OPAL		C/D	C/D	A/M	A/B/M	A/B/M	A/B/M	A/B/M	A/B/M	A/B/M	A/B/M	B/M	B/M	M	M	-	M	M	A/M	
NEW OPAL		C/D	C/D	A/M	A/B/M	A/B/M	A/B/M	A/B/M	A/B/M	A/B/M	A/B/M	B/M	B/M	M	M	-	M	M	A/M	
MALMÖ / PADUA		C/D	C/D	A/M	A/B/M	A/B/M	A/B/M	A/B/M	A/B/M	A/B/M	A/B/M	B/M	B/M	M	M	-	-	-	A/M	
ATLANTA		C/D	C/D	A/M	A/B/M	A/B/M	A/B/M	A/B/M	A/B/M	A/B/M	A/B/M	B/M	B/M	-	-	-	-	-	-	
<b>PG6</b>																				
OSLO 15		C/D	C/D	-	A/B/M	A/B/M	A/B/M	A/B/M	A/B/M	A/B/M	A/B/M	B/M	B/M	-	-	-	-	-	A/M	
FLORENZ / MODENA		C/D	C/D	A/M	A/B/M	A/B/M	A/B/M	A/B/M	A/B/M	A/B/M	A/B/M	B/M	B/M	M	M	-	-	-	A/M	
BERGEN		C/D	C/D	A/M	A/B/M	A/B/M	A/B/M	A/B/M	A/B/M	A/B/M	A/B/M	B/M	B/M	-	-	-	-	-	A/M	
TESSIN 15		C/D	C/D	-	A/B/M	A/B/M	A/B/M	A/B/M	A/B/M	A/B/M	A/B/M	B/M	B/M	-	-	-	-	-	A/M	
LUGANO		C/D	C/D	A/M	A/B/M	A/B/M	A/B/M	A/B/M	A/B/M	A/B/M	A/B/M	B/M	B/M	-	-	-	-	-	A/M	
BAVARIA / MUNICH		C/D	C/D	A/M	A/B/M	A/B/M	A/B/M	A/B/M	A/B/M	A/B/M	A/B/M	B/M	B/M	M	M	-	-	-	A/M	
SMART MIRROR		C/D	C/D	A/M	A/B/M	A/B/M	A/B/M	A/B/M	A/B/M	A/B/M	A/B/M	B/M	B/M	M	M	-	M	M	A/M	
VINO		C/D	C/D	A/M	A/B/M	A/B/M	A/B/M	A/B/M	A/B/M	A/B/M	A/B/M	B/M	B/M	-	-	-	-	-	-	
TIM		C/D	C/D	A/M	A/B/M	A/B/M	A/B/M	A/B/M	A/B/M	A/B/M	A/B/M	B/M	B/M	M	M	-	-	-	A/M	
TIM 15		C/D	C/D	-	A/B/M	A/B/M	A/B/M	A/B/M	A/B/M	A/B/M	A/B/M	B/M	B/M	-	M	-	-	-	A/M	
ORLANDO		C/D	C/D	A/M	A/B/M	A/B/M	A/B/M	A/B/M	A/B/M	A/B/M	A/B/M	B/M	B/M	-	-	-	-	-	-	
MULTIPLY		C/D	C/D	A/M	A/B/M	A/B/M	A/B/M	A/B/M	A/B/M	A/B/M	A/B/M	B/M	B/M	-	-	-	-	M	A/M	
<b>PG7</b>																				
CASTELLO		C/D	-	-	A/B/M	A/B/M	A/B/M	A/B/M	A/B/M	A/B/M	A/B/M	B/M	B/M	-	-	-	-	-	-	
MONTANA		C/D	C/D	A/M	A/B/M	A/B/M	A/B/M	A/B/M	A/B/M	A/B/M	A/B/M	B/M	B/M	M	M	-	-	-	A/M	
NEVADA		C/D	C/D	A/M	A/B/M	A/B/M	A/B/M	A/B/M	A/B/M	A/B/M	A/B/M	B/M	B/M	M	M	-	-	-	A/M	
RUSTY OAK		C/D	C/D	A/M	A/B/M	A/B/M	A/B/M	A/B/M	A/B/M	A/B/M	A/B/M	B/M	B/M	M	M	-	-	-	A/M	
ALU TEC RP		C/D	C/D	A/M	A/B/M	A/B/M	A/B/M	A/B/M	A/B/M	A/B/M	A/B/M	B/M	B/M	-	-	-	-	-	A/M	
CHICAGO		C/D	C/D	A/M	A/B/M	A/B/M	A/B/M	A/B/M	A/B/M	A/B/M	A/B/M	B/M	B/M	-	-	-	-	-	-	
<b>PG8</b>																				
TALEA		C/D	C/D	A/M	A/B/M	A/B/M	A/B/M	A/B/M	A/B/M	A/B/M	A/B/M	B/M	B/M	M	M	-	-	-	A/M	
INTARSIA		C/D	C/D	A/M	A/B/M	A/B/M	A/B/M	A/B/M	A/B/M	A/B/M	A/B/M	B/M	B/M	M	M	-	-	-	A/M	

# Worktop decor group AP/APD



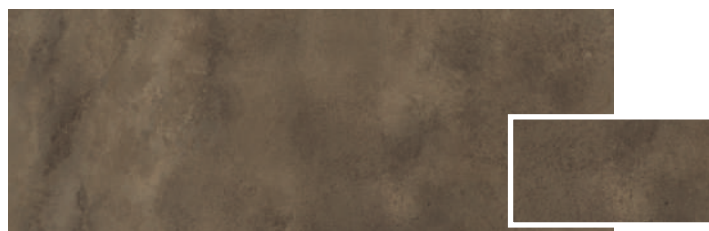
**1200 Roxano volcano black**

4 cm AP/APD	5 cm AP5D	1.6 cm AP16D	2.5 cm AP25D
x only APD	x	x	-



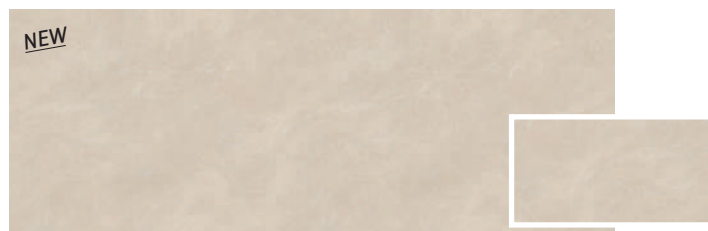
**1210 Metal Rock anthracite**

4 cm AP/APD	5 cm AP5D	1.6 cm AP16D	2.5 cm AP25D
x	x	-	-



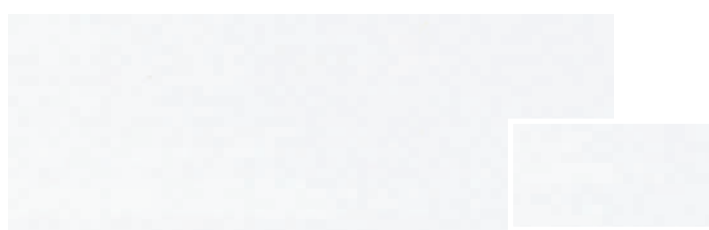
**2260 Sand beige titanite**

4 cm AP/APD	5 cm AP5D	1.6 cm AP16D	2.5 cm AP25D
x	x	-	-



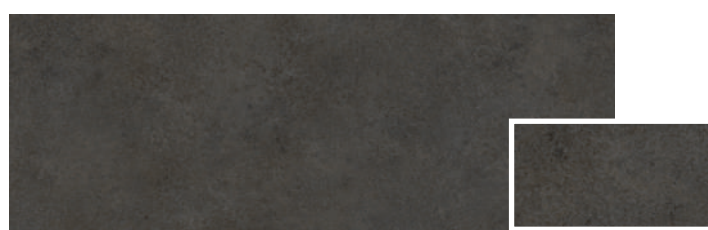
**2650 Natural sandstone effect**

4 cm AP/APD	5 cm AP5D	1.6 cm AP16D	2.5 cm AP25D
x	x	x	x



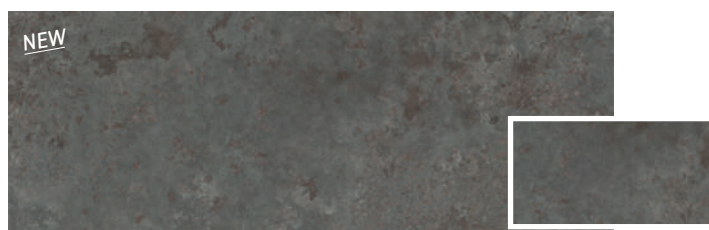
**2701 snow white spatula look effect**

4 cm AP/APD	5 cm AP5D	1.6 cm AP16D	2.5 cm AP25D
x	x	-	-



**3797 Mocca**

4 cm AP/APD	5 cm AP5D	1.6 cm AP16D	2.5 cm AP25D
x	x	x	-



**4268 natural Green Ceramic**

4 cm AP/APD	5 cm AP5D	1.6 cm AP16D	2.5 cm AP25D
x	x	-	x



**4374 Concrete effect opal**

4 cm AP/APD	5 cm AP5D	1.6 cm AP16D	2.5 cm AP25D
x	x	x	x



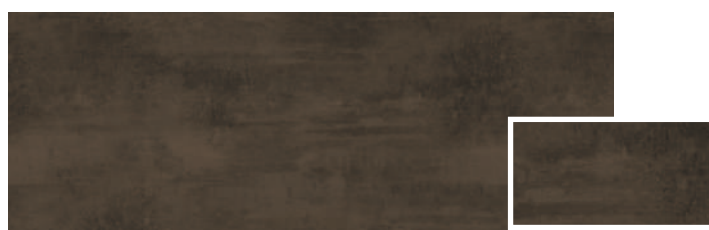
**4375 Concrete effect pearl grey**

4 cm AP/APD	5 cm AP5D	1.6 cm AP16D	2.5 cm AP25D
x	x	x	x



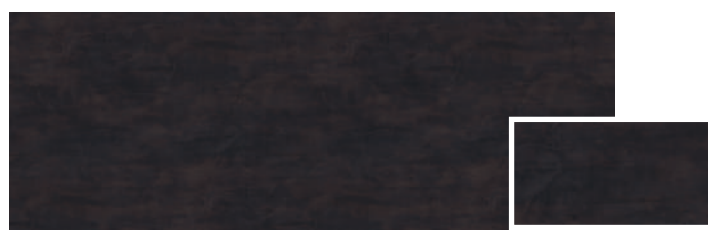
**4440 graphite concrete effect**

4 cm AP/APD	5 cm AP5D	1.6 cm AP16D	2.5 cm AP25D
x	x	x	x



**5579 Brown concrete effect**

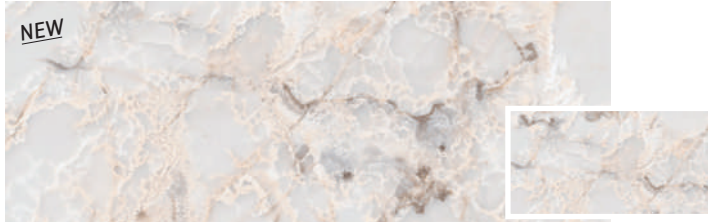
4 cm AP/APD	5 cm AP5D	1.6 cm AP16D	2.5 cm AP25D
x	x	x	x



**6290 Ferro black gold**

4 cm AP/APD	5 cm AP5D	1.6 cm AP16D	2.5 cm AP25D
x	x	x	x

# Worktop decor group AP/APD



**6307** **Natural onyx effect**

4 cm AP/APD	5 cm AP5D	1.6 cm AP16D	2.5 cm AP25D
x	x	-	x



**8000** **Crystal marble**

4 cm AP/APD	5 cm AP5D	1.6 cm AP16D	2.5 cm AP25D
x	x	-	x



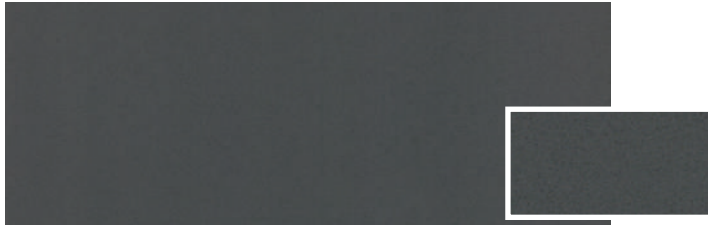
**9200** **Cupria marble**

4 cm AP/APD	5 cm AP5D	1.6 cm AP16D	2.5 cm AP25D
x	x	-	x



**9612** **Graphite Black stone look**

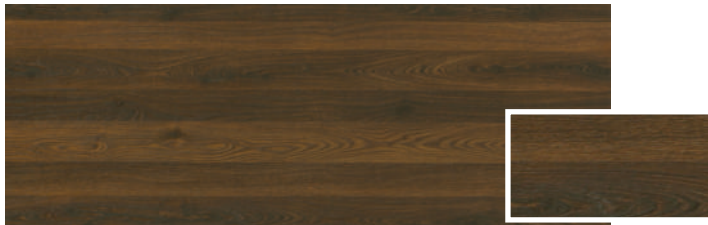
4 cm AP/APD	5 cm AP5D	1.6 cm AP16D	2.5 cm AP25D
x	x	-	-



**9630** **Art Pepper stone look**

4 cm AP/APD	5 cm AP5D	1.6 cm AP16D	2.5 cm AP25D
x	x	-	-

## Worktop decor group AP/APD Wood decor



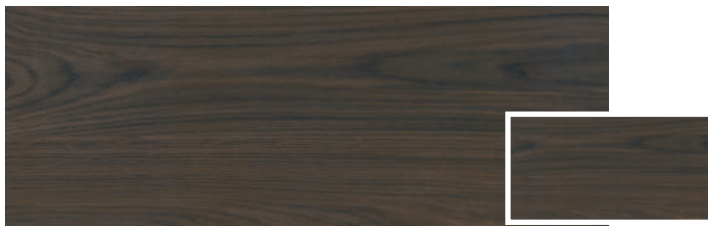
**1070** **Bordeaux oak effect**

4 cm AP/APD	5 cm AP5D	1.6 cm AP16D	2.5 cm AP25D
-	-	x	-



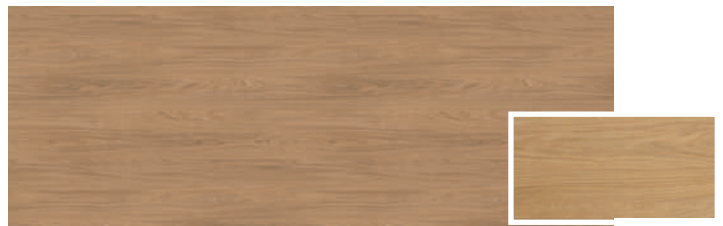
**1180** **natural mountain oak effect**

4 cm AP/APD	5 cm AP5D	1.6 cm AP16D	2.5 cm AP25D
x	x	-	x



**1369** **Dark Maron effect**

4 cm AP/APD	5 cm AP5D	1.6 cm AP16D	2.5 cm AP25D
x	x	-	x



**1385** **Royal Oak effect**

4 cm AP/APD	5 cm AP5D	1.6 cm AP16D	2.5 cm AP25D
x	x	-	x



**2032** **Wild Oak Repro**

4 cm AP/APD	5 cm AP5D	1.6 cm AP16D	2.5 cm AP25D
x	x	-	-



**2240** **Diamond oak effect**

4 cm AP/APD	5 cm AP5D	1.6 cm AP16D	2.5 cm AP25D
x	x	-	x



# Worktop decor group AP/APD Wood decor



**2406 Mountain Wood**

4 cm AP/APD	5 cm AP5D	1.6 cm AP16D	2.5 cm AP25D
x	x	-	x



**3157 Piemont Oak Repro**

4 cm AP/APD	5 cm AP5D	1.6 cm AP16D	2.5 cm AP25D
x	x	-	x



**4262 Castell Oak-Effect**

4 cm AP/APD	5 cm AP5D	1.6 cm AP16D	2.5 cm AP25D
x	x	x	x



**4326 Elegant walnut effect**

4 cm AP/APD	5 cm AP5D	1.6 cm AP16D	2.5 cm AP25D
x	x	-	x



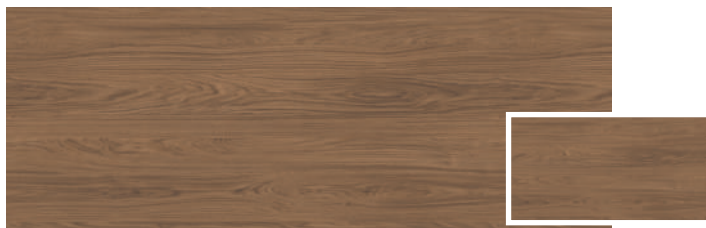
**5411 Mammoth oak repro. natural**

4 cm AP/APD	5 cm AP5D	1.6 cm AP16D	2.5 cm AP25D
x	x	x	x



**5573 Classic Oak effect**

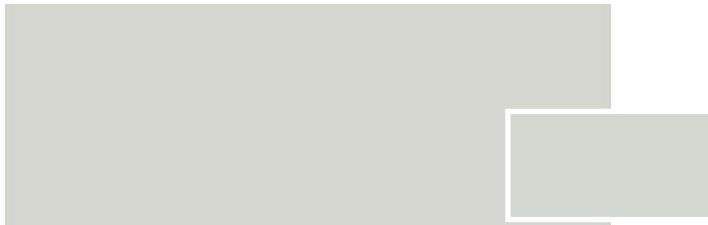
4 cm AP/APD	5 cm AP5D	1.6 cm AP16D	2.5 cm AP25D
x	x	x	x



**9386 Seal Oak effect**

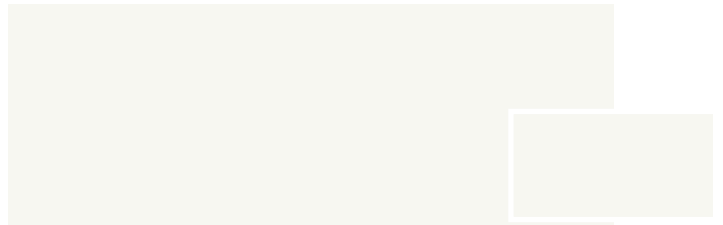
4 cm AP/APD	5 cm AP5D	1.6 cm AP16D	2.5 cm AP25D
x	x	-	-

# Worktop decors (decor group AP16R/AP25R)



**1640 RESOPAL PRO Jura Grey**  

4 cm AP/APD	5 cm AP5D	1.6 cm AP16D	2.5 cm AP25R
-	-	x	x



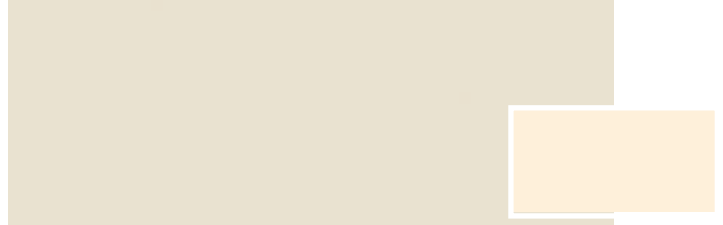
**1880 RESOPAL PRO cool white**  

4 cm AP/APD	5 cm AP5D	1.6 cm AP16D	2.5 cm AP25R
-	-	x	x



**2111 RESOPAL PRO Moonlight Green**  

4 cm AP/APD	5 cm AP5D	1.6 cm AP16D	2.5 cm AP25R
-	-	x	x



**3170 RESOPAL PRO Macaron powder**  

4 cm AP/APD	5 cm AP5D	1.6 cm AP16D	2.5 cm AP25R
-	-	x	x



**5360 RESOPAL PRO dark powder**  

4 cm AP/APD	5 cm AP5D	1.6 cm AP16D	2.5 cm AP25R
-	-	x	x



**5380 RESOPAL PRO light powder**  

4 cm AP/APD	5 cm AP5D	1.6 cm AP16D	2.5 cm AP25R
-	-	x	x



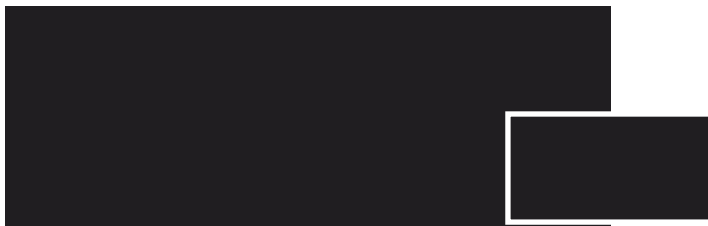
**5460 RESOPAL PRO brown powder**  

4 cm AP/APD	5 cm AP5D	1.6 cm AP16D	2.5 cm AP25R
-	-	x	x



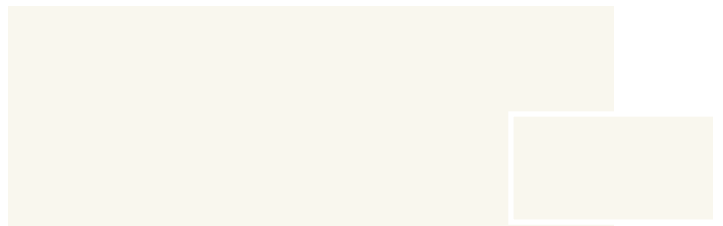
**6300 RESOPAL PRO anthracite**  

4 cm AP/APD	5 cm AP5D	1.6 cm AP16D	2.5 cm AP25R
-	-	x	x



**9015 RESOPAL PRO black**  

4 cm AP/APD	5 cm AP5D	1.6 cm AP16D	2.5 cm AP25R
-	-	x	x



**9410 RESOPAL PRO premium white**  

4 cm AP/APD	5 cm AP5D	1.6 cm AP16D	2.5 cm AP25R
-	-	x	x



**9600 RESOPAL PRO nature powder**  

4 cm AP/APD	5 cm AP5D	1.6 cm AP16D	2.5 cm AP25R
-	-	x	x



**9950 RESOPAL PRO titanium grey**  

4 cm AP/APD	5 cm AP5D	1.6 cm AP16D	2.5 cm AP25R
-	-	x	x



# Maximum dimensions

Decor group / colour number	front colour	Panel decors 1.0 cm	Panel decors 1.6 cm	Panel decors 1.9 cm	Panel decors 2.5 cm	Panel decors 5 cm	Stiles 10 cm	Carcase material	Recess back panel
<b>M 10</b>	<b>Decor group K</b>	(H x W)	(H x W)	(H x W)	(H x W)	(H x W)	(H x W)	Z31... (H x W)	NRW... (W x H)
K006P	Light Grey	-	2635 x 2050	2635 x 2050	4080 x 1200	-	2500 x 1200	2635 x 2050	4080 x 1010
K023P	Stainless Steel Colour	-	2780 x 2050	2780 x 2050	4080 x 1200	2500 x 1200	2500 x 1200	2780 x 2050	4080 x 1010
K039P	Premium white	-	2635 x 2050	2635 x 2050	4080 x 1200	2500 x 1200	2500 x 1200	2635 x 2050	4080 x 1010
K043P	Graphite Black	-	2780 x 2050	2780 x 2050	4080 x 1200	2500 x 1200	2500 x 1200	2780 x 2050	4080 x 1010
K058P	Magic-grey	-	2635 x 2050	2635 x 2050	4080 x 1200	2500 x 1200	2500 x 1200	2635 x 2050	4080 x 1010
K075P	Black	-	2780 x 2050	2780 x 2050	4080 x 1200	2500 x 1200	2500 x 1200	2780 x 2050	4080 x 1010
K076P	Macaron	-	2780 x 2050	2780 x 2050	4080 x 1200	2500 x 1200	2500 x 1200	2780 x 2050	4080 x 1010
K160F	Snow White	-	2780 x 2050	2780 x 2050	4080 x 1200	2500 x 1200	2500 x 1200	2780 x 2050	4080 x 1010
K178F	White Agate	-	2780 x 2050	2780 x 2050	4080 x 1200	2500 x 1200	2500 x 1200	2780 x 2050	4080 x 1010
K218P	Light Pepper	-	2780 x 2050	2780 x 2050	4080 x 1200	2500 x 1200	2500 x 1200	2780 x 2050	4080 x 1010
K230P	Art Pepper	-	2780 x 2050	2780 x 2050	4080 x 1200	2500 x 1200	2500 x 1200	2780 x 2050	4080 x 1010
K235P	Titan Steel	-	2780 x 2050	2780 x 2050	4080 x 1200	2500 x 1200	2500 x 1200	2780 x 2050	4080 x 1010
K248P	Light Nude	-	2780 x 2050	2780 x 2050	4080 x 1200	2500 x 1200	2500 x 1200	2780 x 2050	4080 x 1010
K263P	Fango	-	2635 x 2050	2635 x 2050	4080 x 1200	2500 x 1200	2500 x 1200	2635 x 2050	4080 x 1010
K039G	Premium white glossy	-	2780 x 2050	2780 x 2050	4080 x 1200	2500 x 1200	2500 x 1200	2780 x 2050	4080 x 1010
K160G	Snow White Gloss	-	2780 x 2050	2780 x 2050	4080 x 1200	2500 x 1200	2500 x 1200	2780 x 2050	4080 x 1010
K005S	Castell Oak Repro.	-	2635 x 2050	2635 x 2050	4080 x 1200	2500 x 1200	2500 x 1200	2635 x 2050	4080 x 1010
K190S	Mammoth oak repro. natural	-	2780 x 2050	2780 x 2050	4080 x 1200	2500 x 1200	2500 x 1200	2780 x 2050	4080 x 1010
K199S	Piemont Oak Repro	-	2780 x 2050	2780 x 2050	4080 x 1200	2500 x 1200	2500 x 1200	2780 x 2050	4080 x 1010
K216S	natural mountain oak effect	-	2780 x 2050	2780 x 2050	4080 x 1200	2500 x 1200	2500 x 1200	2780 x 2050	4080 x 1010
K229S	Classic Oak effect	-	2780 x 2050	2780 x 2050	4080 x 1200	2500 x 1200	2500 x 1200	2780 x 2050	4080 x 1010
K236S	Diamond oak effect	-	2780 x 2050	2780 x 2050	4080 x 1200	2500 x 1200	2500 x 1200	2780 x 2050	4080 x 1010
K247S	Dark Maron effect	-	2780 x 2050	2780 x 2050	4080 x 1200	2500 x 1200	2500 x 1200	2780 x 2050	4080 x 1010
K262S	Royal Oak effect	-	2780 x 2050	2780 x 2050	4080 x 1200	2500 x 1200	2500 x 1200	2780 x 2050	4080 x 1010
K269S	Mountain Wood	-	2780 x 2050	2780 x 2050	4080 x 1200	2500 x 1200	2500 x 1200	2780 x 2050	4080 x 1010
K270S	Elegant walnut effect	-	2780 x 2050	2780 x 2050	4080 x 1200	2500 x 1200	2500 x 1200	2780 x 2050	4080 x 1010
<b>M 20</b>	<b>Decor group D</b>								
D176S	Sherwood Oak Repro. Black	-	2780 x 2050	-	-	-	2500 x 1200	2780 x 2050	-
D187W	Concrete effect opal	-	2780 x 2050	-	4080 x 1200	-	2500 x 1200	2780 x 2050	2780 x 2050
D188W	Concrete effect pearl grey	-	2780 x 2050	-	4080 x 1200	-	2500 x 1200	2780 x 2050	2780 x 2050
D202S	Sherwood Oak Repro Sepia Grey	-	2780 x 2050	-	-	-	2500 x 1200	2780 x 2050	-
D212W	graphite concrete effect	-	2780 x 2050	-	4080 x 1200	-	2500 x 1200	2780 x 2050	2780 x 2050
D039F	Premium white matt	-	2780 x 2050	-	-	-	2500 x 1200	2780 x 2050	-
D160F	Snow white matt	-	2780 x 2050	-	-	-	2500 x 1200	2780 x 2050	-
D178F	White Agate matt	-	2780 x 2050	-	-	-	2500 x 1200	2780 x 2050	-
D147S	Burnt Wood effect	-	2780 x 2050	-	-	-	2500 x 1200	2780 x 2050	2780 x 2050
D149W	Brown concrete effect	-	2780 x 2050	-	4080 x 1200	-	2500 x 1200	2780 x 2050	2780 x 2050
D224S	Bordeaux oak effect	-	2780 x 2050	-	-	-	2500 x 1200	2780 x 2050	2780 x 2050
D250S	Black Oak effect	-	2780 x 2050	-	-	-	2500 x 1200	2780 x 2050	2780 x 2050
D251S	Seal Oak effect	-	2780 x 2050	-	-	-	2500 x 1200	2780 x 2050	2780 x 2050
D264S	Light oak, grooved look	-	2780 x 2050	-	-	-	2500 x 1200	2780 x 2050	2780 x 2050
D265S	Dark oak, grooved look	-	2780 x 2050	-	-	-	2500 x 1200	2780 x 2050	2780 x 2050
D271W	Natural sandstone effect	-	2780 x 2050	-	-	-	2500 x 1200	2780 x 2050	2780 x 2050
D272F	Jade pastel	-	2780 x 2050	-	-	-	2500 x 1200	2780 x 2050	2780 x 2050

# Maximum dimensions

Decor group / colour number	front colour	Panel decors 1.0 cm	Panel decors 1.6 cm	Panel decors 1.9 cm	Panel decors 2.5 cm	Panel decors 5 cm	Stiles 10 cm	Carcase material	Recess back panel
<b>M 30</b>	Decor group I	(H x W)	(H x W)	(H x W)	(H x W)	(H x W)	(H x W)	Z31... (H x W)	NRW... (W x H)
I139M	RESOPAL PRO Jura Grey	-	3630 x 1300	-	-	-	2500 x 1200	3630 x 1300	3630 x 1300
I039M	RESOPAL PRO premium white	-	3630 x 1300	-	-	-	2500 x 1200	3630 x 1300	3630 x 1300
I075M	RESOPAL PRO black	-	3630 x 1300	-	-	-	2500 x 1200	3630 x 1300	3630 x 1300
I076M	RESOPAL PRO Macaron powder	-	3630 x 1300	-	-	-	2500 x 1200	3630 x 1300	3630 x 1300
I138M	RESOPAL PRO titanium grey	-	3630 x 1300	-	-	-	2500 x 1200	3630 x 1300	3630 x 1300
I140M	RESOPAL PRO anthracite	-	3630 x 1300	-	-	-	2500 x 1200	3630 x 1300	3630 x 1300
I141M	RESOPAL PRO cool white	-	3630 x 1300	-	-	-	2500 x 1200	3630 x 1300	3630 x 1300
I240M	RESOPAL PRO light powder	-	3630 x 1300	-	-	-	2500 x 1200	3630 x 1300	3630 x 1300
I241M	RESOPAL PRO dark powder	-	3630 x 1300	-	-	-	2500 x 1200	3630 x 1300	3630 x 1300
I253M	RESOPAL PRO Moonlight Green	-	3630 x 1300	-	-	-	2500 x 1200	3630 x 1300	3630 x 1300
I267M	RESOPAL PRO brown powder	-	3630 x 1300	-	-	-	2500 x 1200	3630 x 1300	3630 x 1300
I268M	RESOPAL PRO nature powder	-	3630 x 1300	-	-	-	2500 x 1200	3630 x 1300	3630 x 1300
<b>M 30</b>	Decor group I..H	(H x W)	(H x W)	(H x W)	(H x W)	(H x W)	(H x W)	Z31... (H x W)	NRW... (W x H)
I273H	Natural onyx effect	-	4080 x 1280	-	-	-	2500 x 1200	4080 x 1280	4080 x 1280
I274H	Navyblue	-	2780 x 1280	-	-	-	2500 x 1200	2780 x 1280	2780 x 1280
I280H	Smoke Powder	-	2780 x 1280	-	-	-	2500 x 1200	2780 x 1280	2780 x 1280
I281H	Ferro black gold	-	4080 x 1280	-	-	-	2500 x 1200	4080 x 1280	4080 x 1280
<b>M 30</b>	Decor group PW	(H x W)	(H x W)	(H x W)	(H x W)	(H x W)	(H x W)	Z31... (H x W)	NRW... (W x H)
PW258	Gavi oak	-	2480 x 1200	-	-	-	2480 x 1200	2480 x 1200	-
PW259	dark oak	-	2480 x 1200	-	-	-	2480 x 1200	2480 x 1200	-
<b>M 40</b>	Decor group L/A	(H x W)	(H x W)	(H x W)	(H x W)	(H x W)	(H x W)	Z31... (H x W)	NRW... (W x H)
LxxxH	DIRECTLACK high-gloss	-	2780 x 2050	-	-	-	-	2780 x 2050	-
AxxxM	DIRECTLACK matt	-	2780 x 2050	-	-	-	-	2780 x 2050	-
<b>M 50</b>	Decor group S								
SxxxP	micro structured lacquer	2750 x 1300	2750 x 1300	2750 x 1300	2750 x 1300	2750 x 1300	2750 x 1300	2750 x 1300	2750 x 1300
<b>M 50</b>	Decor group B								
BxxxF	velvet lacquer	2750 x 1300	2750 x 1300	2750 x 1300	2750 x 1300	2750 x 1300	2750 x 1300	2750 x 1300	2750 x 1300
<b>M 50</b>	Decor group R								
RxxxW	velvet lacquer spackle effect	-	2750 x 1300	-	-	-	2750 x 1300	-	-
RxxxH	velvet lacquer wood structure	-	2750 x 1300	-	-	-	2750 x 1300	-	-
<b>M 50</b>	Decor group P								
P039M	Premium white		2780 x 1250	-	-	-	-	-	-
<b>M 60</b>	Decor group Q								
QxxxH	SMARTGLAS high-gloss	-	2780 x 1280	-	-	-	2500 x 1200	2500 x 1200	2780 x 1280
QxxxM	SMARTGLAS satin-finish	-	2780 x 1280	-	-	-	2500 x 1200	2500 x 1200	2780 x 1280

# Maximum dimensions

Decor group / colour number	front colour	Panel decors 1.0 cm	Panel decors 1.6 cm	Panel decors 1.9 cm	Panel decors 2.5 cm	Panel decors 5 cm	Stiles 10 cm	Carcase material	Recess back panel
<b>M 70</b>	<b>Decor group F (veneer colours)</b>								
F039S	Oak Premium White	-	2500 x 1200	2500 x 1200	2500 x 1200	2500 x 1200	2500 x 1200	2500 x 1200	-
F043S	Oak Graphite Black	-	2500 x 1200	2500 x 1200	2500 x 1200	2500 x 1200	2500 x 1200	2500 x 1200	-
F058K	Oak Silk Grey	-	2500 x 1200	2500 x 1200	2500 x 1200	2500 x 1200	2500 x 1200	2500 x 1200	-
F075S	Oak schwarz	-	2500 x 1200	2500 x 1200	2500 x 1200	2500 x 1200	2500 x 1200	2500 x 1200	-
F076K	Oak Macaron	-	2500 x 1200	2500 x 1200	2500 x 1200	2500 x 1200	2500 x 1200	2500 x 1200	-
F213K	untreated oak	-	2500 x 1200	2500 x 1200	2500 x 1200	2500 x 1200	2500 x 1200	2500 x 1200	-
F214K	coffee brown oak	-	2500 x 1200	2500 x 1200	2500 x 1200	2500 x 1200	2500 x 1200	2500 x 1200	-
F218S	Light Pepper oak	-	2500 x 1200	2500 x 1200	2500 x 1200	2500 x 1200	2500 x 1200	2500 x 1200	-
F230S	oak Art Pepper	-	2500 x 1200	2500 x 1200	2500 x 1200	2500 x 1200	2500 x 1200	2500 x 1200	-
F245S	oak Night Green	-	2500 x 1200	2500 x 1200	2500 x 1200	2500 x 1200	2500 x 1200	2500 x 1200	-
F248S	Light Nude oak	-	2500 x 1200	2500 x 1200	2500 x 1200	2500 x 1200	2500 x 1200	2500 x 1200	-
F261K	Urban Oak	-	2500 x 1200	2500 x 1200	2500 x 1200	2500 x 1200	2500 x 1200	2500 x 1200	-
F263S	Fango oak	-	2500 x 1200	2500 x 1200	2500 x 1200	2500 x 1200	2500 x 1200	2500 x 1200	-
F231K	Walnut Veneer	-	2500 x 1200	2500 x 1200	2500 x 1200	2500 x 1200	2500 x 1200	2500 x 1200	-
F257K	Rosso walnut veneer	-	2500 x 1200	2500 x 1200	2500 x 1200	2500 x 1200	2500 x 1200	2500 x 1200	-
F258K	Gavi oak	-	2500 x 1200	2500 x 1200	2500 x 1200	2500 x 1200	2500 x 1200	2500 x 1200	-
F259K	dark oak	-	2500 x 1200	2500 x 1200	2500 x 1200	2500 x 1200	2500 x 1200	2500 x 1200	-
F279K	Moderno Rustico oak	-	2500 x 1200	2500 x 1200	2500 x 1200	2500 x 1200	2500 x 1200	2500 x 1200	-
F099K	Special finish oak veneer	-	2500 x 1200	2500 x 1200	2500 x 1200	2500 x 1200	2500 x 1200	2500 x 1200	-
<b>M 70</b>	<b>Decor group Z (Bavaria oak)</b>								
Z039S	Bavaria oak premium white	-	2500 x 1200	2500 x 1200	2500 x 1200	2500 x 1200	2500 x 1200	2500 x 1200	-
Z043S	Bavaria oak graphite black	-	2500 x 1200	2500 x 1200	2500 x 1200	2500 x 1200	2500 x 1200	2500 x 1200	-
Z058K	Bavaria oak silky grey	-	2500 x 1200	2500 x 1200	2500 x 1200	2500 x 1200	2500 x 1200	2500 x 1200	-
Z075S	Bavaria oak black	-	2500 x 1200	2500 x 1200	2500 x 1200	2500 x 1200	2500 x 1200	2500 x 1200	-
Z076K	Bavaria oak Macaron	-	2500 x 1200	2500 x 1200	2500 x 1200	2500 x 1200	2500 x 1200	2500 x 1200	-
Z213K	Untreated Bavaria oak	-	2500 x 1200	2500 x 1200	2500 x 1200	2500 x 1200	2500 x 1200	2500 x 1200	-
Z214K	coffee brown Bavaria oak	-	2500 x 1200	2500 x 1200	2500 x 1200	2500 x 1200	2500 x 1200	2500 x 1200	-
Z218S	Bavaria oak Light Pepper	-	2500 x 1200	2500 x 1200	2500 x 1200	2500 x 1200	2500 x 1200	2500 x 1200	-
Z230S	Bavaria oak Art Pepper	-	2500 x 1200	2500 x 1200	2500 x 1200	2500 x 1200	2500 x 1200	2500 x 1200	-
Z245S	Bavaria oak Night Green	-	2500 x 1200	2500 x 1200	2500 x 1200	2500 x 1200	2500 x 1200	2500 x 1200	-
Z248S	Light Nude Bavaria oak	-	2500 x 1200	2500 x 1200	2500 x 1200	2500 x 1200	2500 x 1200	2500 x 1200	-
Z258K	Bavaria Gavi oak	-	2500 x 1200	2500 x 1200	2500 x 1200	2500 x 1200	2500 x 1200	2500 x 1200	-
Z259K	Bavaria dark oak	-	2500 x 1200	2500 x 1200	2500 x 1200	2500 x 1200	2500 x 1200	2500 x 1200	-
Z261K	Bavaria Urban Oak	-	2500 x 1200	2500 x 1200	2500 x 1200	2500 x 1200	2500 x 1200	2500 x 1200	-
Z263S	Fango Bavaria oak	-	2500 x 1200	2500 x 1200	2500 x 1200	2500 x 1200	2500 x 1200	2500 x 1200	-
Z279K	Bavaria oak Moderno Rustico	-	2500 x 1200	2500 x 1200	2500 x 1200	2500 x 1200	2500 x 1200	2500 x 1200	-
Z099K	Bavaria oak veneer special lacquering	-	2500 x 1200	2500 x 1200	2500 x 1200	2500 x 1200	2500 x 1200	2500 x 1200	-
<b>M 70</b>	<b>Decor group V</b>								
V195W	Bronze Metallic	-	2750 x 1300	-	-	-	2750 x 1300	-	-
V246W	Basalt Metallic	-	2750 x 1300	-	-	-	2750 x 1300	-	-
V182W	Silver Metallic	-	2750 x 1300	-	-	-	2750 x 1300	-	-
V183W	Gold Metallic	-	2750 x 1300	-	-	-	2750 x 1300	-	-
V194W	Copper Metallic	-	2750 x 1300	-	-	-	2750 x 1300	--	-
V235W	Titan Metallic	-	2750 x 1300	-	-	-	2750 x 1300	-	-
<b>M 80</b>	<b>Decor group C1</b>								
C023M	FENIX stainless steel look	-	3030 x 1280	-	-	-	2500 x 1200	3030 x 1280	3030 x 1280
<b>M 80</b>	<b>Decor group MP</b>								
MPxxx	Premium matt lacquer	2500 x 1000	2500 x 1000	2500 x 1000	2500 x 1000	2500 x 1000	2500 x 1000	2500 x 1000	2500 x 1000
<b>M 80</b>	<b>Decor group H</b>								
HxxxH	high gloss-lacquer	2500 x 1000	2500 x 1000	2500 x 1000	2500 x 1000	2500 x 1000	2500 x 1000	2500 x 1000	2500 x 1000

# Maximum dimensions

Decor group / colour number	front colour	Panel decors 1.0 cm	Panel decors 1.6 cm	Panel decors 1.9 cm	Panel decors 2.5 cm	Panel decors 5 cm	Stiles 10 cm	Carcase material	Recess back panel
<b>M 80</b>	Decor group O								
O170S	Antique Oak	-	2500 x 1200	-	2500 x 1200	-	-	2500 x 1200	-
O197S	light Spessart oak	-	2500 x 1200	-	2500 x 1200	-	-	2500 x 1200	-
O215S	larch veneer	-	2500 x 1200	-	2500 x 1200	-	-	2500 x 1200	-
O232S	Spessart-oak leached	-	2500 x 1200	-	2500 x 1200	-	-	2500 x 1200	-
O233S	Spessart-oak Honey	-	2500 x 1200	-	2500 x 1200	-	-	2500 x 1200	-
O259K	Dark oak stained	-	2500 x 1200	-	2500 x 1200	-	-	2500 x 1200	-
<b>M 90</b>	Decor group worktop decors A1	(H x W)	(H x W)	(H x W)	(H x W)	(H x W)		Z31... (H x W)	NRW... (W x H)
1070	Bordeaux oak effect	-	-	-	-	-	-	-	-
1180	natural mountain oak effect	-	-	-	-	-	-	-	-
1200	Roxano volcano black	-	4080 x 1280	-	-	-	-	-	4080 x 1280
1210	Metal Rock anthracite	-	4080 x 1280	-	-	-	-	-	4080 x 1280
1369	Dark Maron effect	-	-	-	-	-	-	-	-
1385	Royal Oak effect	-	-	-	-	-	-	-	-
2032	Wild Oak Repro	-	4080 x 1280	-	-	-	-	-	4080 x 1280
2260	Sand beige titanite	-	4080 x 1280	-	-	-	-	-	4080 x 1280
2406	Mountain Wood	-	-	-	-	-	-	-	-
2650	Natural sandstone effect	-	-	-	-	-	-	-	-
2701	snow white spatula look effect	-	3630 x 1280	-	-	-	-	-	3630 x 1280
3157	Piemont Oak Repro	-	-	-	-	-	-	-	-
3797	Mocca	-	3630 x 1280	-	-	-	-	-	3630 x 1280
4262	Castell Oak-Effect	-	-	-	-	-	-	-	-
4268	natural Green Ceramic	-	3630 x 1280	-	-	-	-	-	3630 x 1280
4326	Elegant walnut effect	-	-	-	-	-	-	-	-
4374	Concrete effect opal	-	-	-	-	-	-	-	-
4375	Concrete effect pearl grey	-	-	-	-	-	-	-	-
4440	graphite concrete effect	-	-	-	-	-	-	-	-
5411	Mammoth oak repro. natural	-	-	-	-	-	-	-	-
5573	Classic Oak effect	-	-	-	-	-	-	-	-
5579	Brown concrete effect	-	-	-	-	-	-	-	-
6290	Ferro black gold	-	-	-	-	-	-	-	-
6307	Natural onyx effect	-	-	-	-	-	-	-	-
8000	Crystal marble	-	4080 x 1280	-	-	-	-	-	4080 x 1280
9200	Cupria marble	-	4080 x 1280	-	-	-	-	-	4080 x 1280
9386	Seal Oak effect	-	-	-	-	-	-	-	-
9612	Graphite Black stone look	-	4080 x 1280	-	-	-	-	-	4080 x 1280
9630	Art Pepper stone look	-	4080 x 1280	-	-	-	-	-	4080 x 1280

# Max. dimensions for front material

The grain is determined by the structure of the base front

(article no. FM, FM2 and FMR)

Model		Max. size in mm		
<b>PG1</b>			<b>PG6</b>	
<b>TOP</b>	coated with melamine resin	2600 x 1200	<b>MULTIPLEX</b>	Laminate with multiplex edge   2490 x 1200
<b>TREND</b>	wood texture	2000 x 1200	<b>OSLO 15</b>	oak veneer with groove 15 cm   1556 x 1300
<b>PG2</b>			<b>LUGANO</b>	
<b>PUR</b>	DIRECTLACK matt	2600 x 1200		Bavaria oak veneer cassette   1556 x 1300
<b>EDITION</b>	DIRECTLACK high-gloss	2600 x 1200	<b>BAVARIA</b>	Bavaria oak veneer vertical   2500 x 1300
<b>PG3</b>			<b>MUNICH</b>	
<b>RESOPAL PRO</b>	RESOPAL super matt	3500 x 1250		Bavaria oak veneer horizontal   1426 x 1300
<b>RESOPAL PRO</b>	RESOPAL super matt	3500 x 1250	<b>TESSIN 15</b>	Bavaria oak veneer groove 15 cm   1556 x 1300
<b>EDGE</b>			<b>BERGEN</b>	oak veneer, coffered   1556 x 1300
<b>RESOPAL</b>	RESOPAL super matt	3500 x 1250	<b>FLORENZ</b>	walnut veneer vertical   2500 x 1300
<b>HPL PRO</b>	ferro black gold	4080 x 1280	<b>MODENA</b>	walnut veneer horizontal   1556 x 1300
<b>HPL PRO</b>	Natural onyx effect	4080 x 1280	<b>TIM</b>	Veneer   2500 x 1300
<b>HPL PRO</b>	Navyblue	2780 x 1280	<b>TIM 15</b>	Veneer   1556 x 1300
<b>HPL PRO</b>	Smoke Powder	2780 x 1280	<b>VINO</b>	Soft lacquer   1426 x 596
<b>SHERWOOD</b>	wood texture	2600 x 1200	<b>ORLANDO-S</b>	Microstructur lacquer   1556 x 1300
<b>PRIMEWOOD TOP</b>	Veneer	2480 x 1200	<b>ORLANDO-B</b>	Velvet lacquer   1556 x 1300
<b>RIVA</b>	wood texture	2600 x 1200	<b>SMART MIRROR</b>	mirror effect   2400 x 1200
<b>GARDA</b>	wood texture	2000 x 1200	<b>PG7</b>	
<b>FRAME</b>	Cassette front 5-part	1426 x 596	<b>ALU TEC RP</b>	RESOPAL with real aluminum edge   2800 x 1250
<b>FRAME</b>	Cassette front 5-part	596 x 1426	<b>CHICAGO</b>	Veneer   1556 x 1300
<b>GENT</b>	wood texture	2500 x 1250	<b>MONTANA</b>	Veneer   2500 x 1300
<b>MIAMI</b>	High gloss-Lacquer	1300 x 2500	<b>NEVADA</b>	Veneer   1426 x 1300
<b>VIVA</b>	Soft lacquer	1426 x 596	<b>CASTELLO</b>	matt lacquer cassette groove   1426 x 596
<b>ARTE-S</b>	Microstructur lacquer	2500 x 1300	<b>CASTELLO</b>	matt lacquer cassette groove   596 x 1426
<b>ARTE-B</b>	Velvet lacquer	2500 x 1300	<b>PG8</b>	
<b>PALERMO-S</b>	micro textured lacquer with groove	2500 x 1300	<b>TALEA</b>	Veneer   2500 x 1220
<b>PALERMO-B</b>	velvet lacquer with groove	2500 x 1300		
<b>ROMA-S</b>	Microstructur lacquer	2500 x 1300		
<b>ROMA-B</b>	Velvet lacquer	2500 x 1300		
<b>SIGNUM-B</b>	Velvet lacquer wood texture	2500 x 1300		
<b>CASA-B</b>	velvet lacquer putty effect	2500 x 1300		
<b>PG4</b>				
<b>SMART</b>	SMARTGLAS high-gloss	2600 x 1200		
<b>SMART-M</b>	SMARTGLAS satin-finish	2600 x 1200		
<b>VILLAGE 15-S</b>	micro textured lacquer with groove	2500 x 1300		
<b>VILLAGE 15-S</b>	micro textured lacquer with groove	1300 x 2500		
<b>VILLAGE 15-B</b>	velvet lacquer with groove	2500 x 1300		
<b>VILLAGE 15-B</b>	velvet lacquer with groove	1300 x 2500		
<b>NOBEL-S</b>	micro textured lacquer frame	1556 x 1300		
<b>NOBEL-B</b>	velvet lacquer frame	1556 x 1300		
<b>SOFIE-S</b>	micro textured lacquer frame	1556 x 1300		
<b>SOFIE-B</b>	velvet lacquer frame	1556 x 1300		
<b>LUX-B</b>	velvet lacquer frame wood texture	1556 x 1300		
<b>PALAZZO</b>	Velvet lacquer textured	2500 x 1300		
<b>PG5</b>				
<b>ATLANTA-S</b>	Microstructur lacquer	1556 x 1300		
<b>ATLANTA-B</b>	Velvet lacquer	1556 x 1300		
<b>YORK-S</b>	micro textured lacquer frame	1556 x 1300		
<b>YORK-B</b>	velvet lacquer frame	1556 x 1300		
<b>CHALET-S</b>	micro textured lacquer frame	1556 x 1300		
<b>CHALET-B</b>	velvet lacquer frame	1556 x 1300		
<b>NEW OPAL-M</b>	Premium matt lacquer	2300 x 1000		
<b>OPAL-H</b>	High gloss-Lacquer	2300 x 1000		
<b>MALMÖ</b>	oak veneer smooth vertical	2500 x 1300		
<b>PADUA</b>	oak veneer smooth horizontal	1556 x 1300		
<b>FENIX INOX</b>	FENIX stainless steel look	2600 x 1200		



# 3

## Base units

Hanging base units

Heights 39, 52, 65 cm

Base units 52 cm high

Base units 65 cm high

Height 71.5 cm

Height 78 cm

Height 78 cm PREMIUMLINE

Height 84.5 cm

Height 84.5 cm PREMIUMLINE

Base units 91 cm high

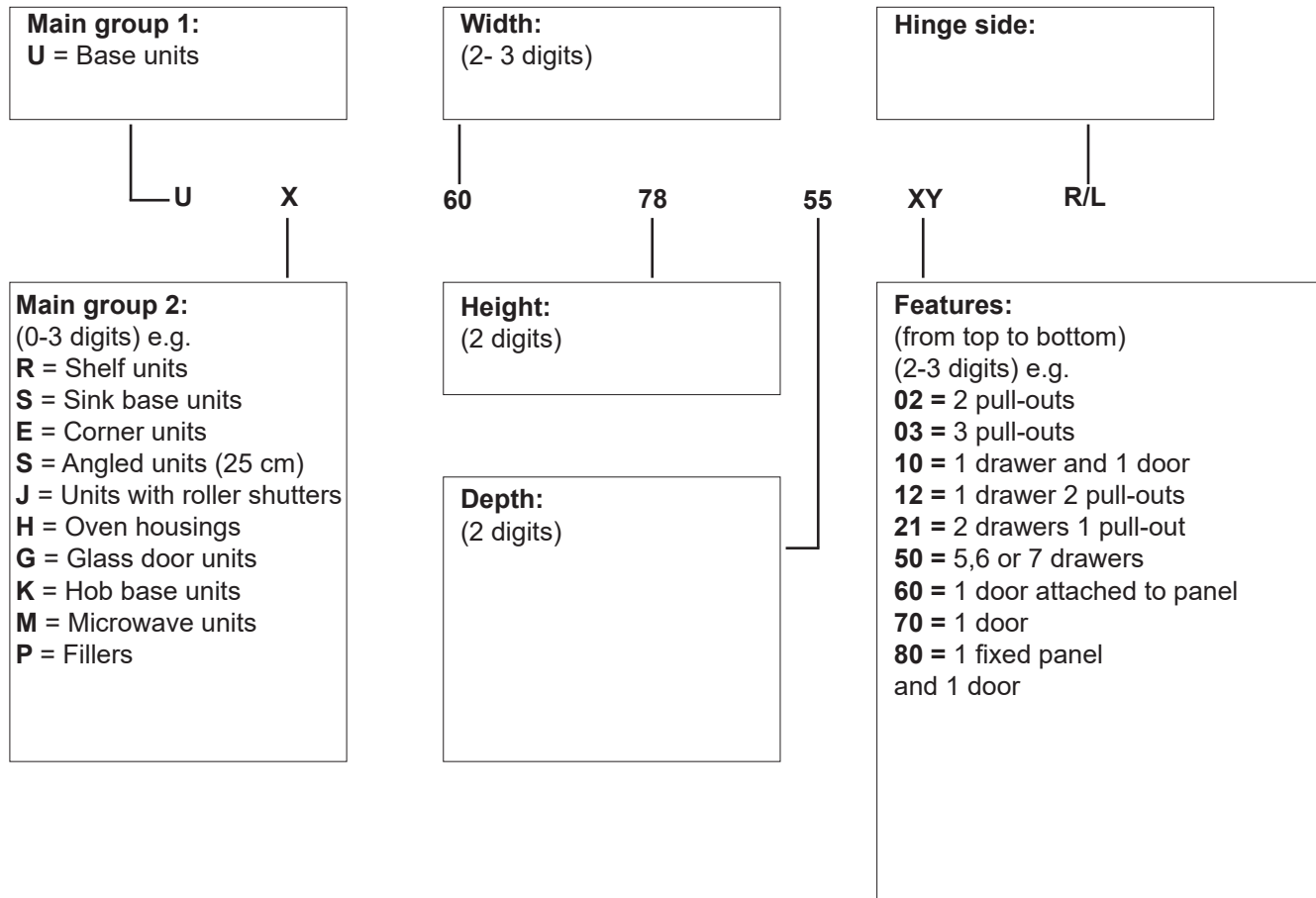
Modular system Y kitchen accessories

Sliding door solutions for base units



# Technical information for base units

## Explanation of order number



## Product advantages:

- metal interior fittings with galvanised brilliant chrome plating
- interior decor identical to carcass exterior
- 8.3 % **more storage space** for a carcass height of 78 cm
- 27 % **more storage space** for a carcass depth of 70.5 cm compared to 55.5 cm
- **high-quality appearance by uniform jointing**
- **no** extra charge for carcass depth 45.5 cm and 34 cm
- oven housings with 17.5 cm **panel**
- sink base units available optionally with **or** without an aluminium protective shelf

# Hanging base units

## Planning advice

### A kitchen designed for all tastes

Base units and tall units without plinth appear to float in the room, giving the room a touch of light modernity. To this end, we offer base units in the carcass heights

39 cm (3 grids),  
52 cm (4 grids) and  
65 cm (5 grids)

and tall units (crockery cupboards) in the carcass heights

143 cm (11 grids),  
156 cm (12 grids),  
168.8 cm (13 grids),  
181.8 cm (14 grids) and  
194.8 cm (15 grids),

to be mounted on the wall.

Planning options range from a completely free-hanging line of base units to a corner combination with connection to floor-mounted base units.

The available base units and tall units are prepared for wall mounting at the factory.

One heavy-duty fitting complete with cap is fitted in the right and left-hand carcass sides.

### Wall-mounting hardware must be provided by the customer!

The units must be mounted directly on the wall. Suitable hardware (screws and raw plugs) for mounting the units on the wall must be decided upon and procured by the customer.

### Assembly instructions:

The fittings are installed in the carcass sides and may not be changed. They may only be installed by authorised persons. Robust attachment requires a wall of suitable load-bearing capacity. Wall-mounting hardware is not included in the scope of delivery and must therefore be obtained by the customer.

The load-bearing capacity and nature of the wall, as well as the precise type of attachment must always be decided on site by a structural engineer or correspondingly authorized person. We cannot accept any liability for property damage or personal injury due to improper installation or inadequate building strength.

## Legend



### Hanging base units

All indicated cabinet types are approved for mounting on the wall without plinth.  
Carcass depths: 45.5/55.5/61,0 cm  
Carcass depth: 34 cm only with hinged doors

**Note:** not available for models in carcass depth 34 cm with drawers and/or pull-outs.

### Special features:





Carcass depth 55.5 cm: drawer and pull-out at top always with carcass depth 45.5 cm  
Carcass depth 45.5 cm: drawer and pull-out at top always with carcass depth 34.0 cm

Extra charge per unit model for heavy-duty fittings for hanging base units:

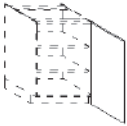
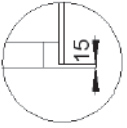



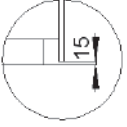


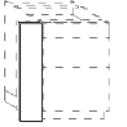
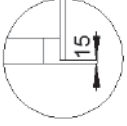

**MP-WST**



# Special finish

		Order no.	Price
<b>Reduction in carcass width</b>			
1. Extra charge refers to next largest element.			
Base units / base shelf units		<b>SA50 BU</b>	86
Dresser bar unit with folding-lifting doors		<b>SA50BABFL</b>	243
Wall units, dresser units		<b>SA50 BH</b>	64
Tall units, tall shelf units		<b>SA50 BS</b>	131
<b>Reduction in carcass depth</b>			
1. Available with drawer and pull-out for elements over 34 cm deep – use of standard drawer and pull-out depths.			
Base units / base shelf units		<b>SA50 TUI</b>	130
Dresser bar unit with folding-lifting doors		<b>SA50TABFL</b>	137
Wall units, dresser units, shelf units		<b>SA50 THI</b>	130
Tall units, tall shelf units		<b>SA50 TSI</b>	145
2. Depth reductions for units with adjustable glass shelves are supplied with adjustable shelves in the carcass decor.			
3. Depth reductions of carcasses with adjustable shelves – usable inside depth adapted to carcass depth			
<b>Reduction in carcass height</b>			
Available for all grid height dimensions (drawers/doors).			
Other dimensions only on consultation.			
		<b>Important!</b> Special heights for tall units only possible via modular system (model GMX...).	
Base units / base shelf units		<b>SA50 HU</b>	86
Dresser bar unit with folding-lifting doors		<b>SA50HABFL</b>	124
Wall units		<b>SA50 HH</b>	64
Dresser unit		<b>SA50 HA</b>	86
Wall shelf units		<b>SA50HHR</b>	72
<b>Dresser unit with roller shutter</b>		<b>SA50HHJ</b>	72
Tall units, tall shelf units		<b>SA50 HS</b>	131
<b>Cutout in rear carcass area</b>			
1. Only possible for base units / tall units where no drawers/pull-outs are planned!			
2. Cutout is not possible for diagonal units.			
3. Base units with a solid top shelf			
4. With corner units, only on request and prior technical check.			
Base units / base shelf units		<b>SA50AKU</b>	109
Wall units, dresser units, shelf units		<b>SA50AKH</b>	100
Tall units, tall shelf units		<b>SA50AKS</b>	169
<b>Variable width of drawers/pull-outs</b>			
<b>Price calculation:</b> Article SA50BU must be taken into account.			
Extra charge refers to next largest element.			
		<b>Not available for:</b> all handles N..., base units with connected panels, design fronts G1, G2, G2S, G5S, G6	
Extra charge for width reduction 1 drawer of 31-119 cm		<b>SA50BSK</b>	48
Extra charge for width reduction 1 pull-out of 31-119 cm		<b>SA50BAZ</b>	57
<b>Surcharge for width reductions of base cabinets with drawers / pull-outs</b>			
		<b>Not available for:</b> all handles N..., base units with connected panels, design fronts G1, G2, G2S, G5S, G6 The cabinet width reduction is included in this surcharge.	
<b>Extra charge for width reductions for base units with drawers/pull-outs</b>		<b>SA50BKU</b>	260
<b>Extra charge Sink carcass with full back panel</b>			
		<b>SA50SVR</b>	34
<b>Extra charge for base units with closed top shelf</b>			
not available for Diagonal and corner base units			
		<b>MP-KBOG</b>	100
<b>Extra charge for heavy-duty fittings wall-mounted units</b>			
		<b>MP-WST</b>	105
<b>Extra charge Plinth blocks screwed per unit</b>			
		<b>Recommendation:</b> For wall-hanging base units: Take into account the extra charge for screw-on plinth blocks <b>MP-SKV</b> We also recommend the screw-on plinth block for plans with panel brackets or plinth bases.	
		<b>MP-SKV</b>	18,40
<b>Extra charge for Drawer/pull-out LEGRABOX WOOD</b>			
		<b>MP-WOOD</b>	170

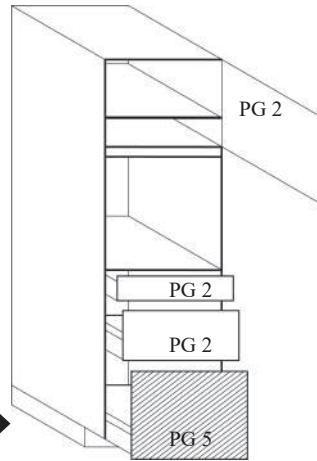
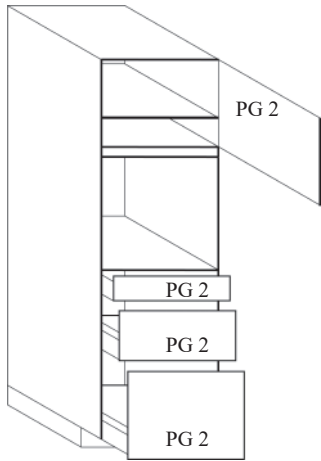
# Front extension

		Order no. W H D	Hinge side:	Carcass depth	Price groups								
					1	2	3	4	5	6	7	8	9
 <p><b>Extra charge front extension for doors in base units</b> extended up to 1.5 cm above floor (1.5 cm less than plinth height) Please note that twice the quantity is needed for 2-door units</p> 	<b>FV 20</b>			46	49	51	72	98	100	109	120	-	
	<b>FV 25</b>			46	49	51	72	98	100	109	120	-	
	<b>FV 30</b>			46	49	51	72	98	100	109	120	-	
	<b>FV 40</b>			49	50	52	76	105	112	121	133	-	
	<b>FV 45</b>			50	51	53	78	109	114	123	135	-	
	<b>FV 50</b>			51	52	54	83	113	120	131	144	-	
	<b>FV 60</b>			53	54	59	87	118	133	144	158	-	
	 <b>Not available for:</b> MIAMI, VIVA												
	 <b>Important!</b> Base units with glass doors, corner units, diagonal units, angled units are <b>not</b> available with front extension. Pinned fronts cannot be extended												
 <p><b>Extra charge front extension for pull-outs</b> Available for pull-out heights: 25.6 cm, 32.1 cm, 38.6 cm, 45.1, 51.6 cm extended up to 1.5 cm above floor (1.5 cm less than plinth height)</p> 	<b>FVA 30</b>			105	109	111	131	158	160	166	183	-	
	<b>FVA 40</b>			112	113	116	140	166	173	183	201	-	
	<b>FVA 45</b>			116	117	119	145	172	179	190	209	-	
	<b>FVA 50</b>			119	120	122	149	180	188	200	220	-	
	<b>FVA 60</b>			122	123	128	157	187	202	213	234	-	
	<b>FVA 70</b>			136	140	144	178	210	220	233	256	-	
	<b>FVA 80</b>			136	140	144	178	210	220	233	256	-	
	<b>FVA 90</b>			144	149	155	188	222	240	257	283	-	
	<b>FVA 100</b>			153	160	164	199	232	260	276	304	-	
	<b>FVA 120</b>			167	181	187	223	259	298	317	349	-	
 <b>Not available for:</b> MIAMI, VIVA													
 <b>Important!</b> Base units with glass doors, corner units, diagonal units, angled units are <b>not</b> available with front extension. Tall units with glass doors, corner units, diagonal units, angled units and tall appliance units with integrated ventilation are <b>not</b> available with front extension. Pinned fronts cannot be extended													
 <p><b>Base unit front filler with front extension</b></p> 	<b>UPFV 10 39</b>			94	98	105	144	169	171	183	201	-	
	<b>UPFV 20 39</b>			107	110	113	161	187	190	195	215	-	
	 <b>Not available for:</b> MIAMI, VIVA												
<p><b>Base unit front filler with front extension</b> extended up to 1.5 cm above floor (1.5 cm less than plinth height)</p>	<b>UPFV 10 52</b>			94	98	105	144	169	171	183	201	-	
	<b>UPFV 20 52</b>			107	110	113	161	187	190	206	227	-	
<p><b>Base unit front filler with front extension</b> extended up to 1.5 cm above floor (1.5 cm less than plinth height)</p>	<b>UPFV 10 65</b>			94	98	105	144	169	171	183	201	-	
	<b>UPFV 20 65</b>			107	110	113	161	187	190	206	227	-	
<p><b>Base unit front filler with front extension</b> extended up to 1.5 cm above floor (1.5 cm less than plinth height)</p>	<b>UPFV 10 72</b>			94	98	105	144	169	171	183	201	-	
	<b>UPFV 20 72</b>			107	110	113	161	187	190	206	227	-	
<p><b>Base unit front filler with front extension</b> extended up to 1.5 cm above floor (1.5 cm less than plinth height)</p>	<b>UPFV 10 78</b>			98	101	107	159	183	187	202	222	-	
	<b>UPFV 20 78</b>			107	110	119	190	214	216	231	254	-	
<p><b>Base unit front filler with front extension</b> extended up to 1.5 cm above floor (1.5 cm less than plinth height)</p>	<b>UPFV 10 85</b>			101	105	110	163	189	192	208	229	-	
	<b>UPFV 20 85</b>			110	113	122	195	222	224	237	261	-	
<p><b>Base unit front filler with front extension</b> extended up to 1.5 cm above floor (1.5 cm less than plinth height)</p>	<b>UPFV 10 91</b>			103	108	110	176	202	205	216	238	-	
	<b>UPFV 20 91</b>			107	112	122	213	237	240	254	279	-	

# Special finish Flex design

Order no.  
W H D

Price groups								
1	2	3	4	5	6	7	8	9



### Front substitution

The new Flex Design enables you to exchange individual fronts within a unit type for fronts from a different model - regardless of whether it is from the same or a different price group, regardless of whether it is a door, pull-out or flap door.

Note: In the case of connected fronts and special elements, an exchange is not always possible. Specific cases will be clarified upon request

Planning and calculation example:

Model:

XL/GL 2641 PUR DIRECTLACK black matt

Unit type:

Appliance tall unit GO 60 19 20 X3

Wish:

Pull-out front bottom 38.6 cm exchanged for Model XL/GL MALMÖ 5924 oak veneer Urban Oak

Dimensions of the front in qm:

(W x H) 59.6 cm x 38.6 cm = 0.23 qm

Extra charge from price group 2 to price group 5:

Article XL: MP-FLDXL-2 0.23 qm x 408.00 €/qm = €94.00

Article GL: MP-FLDGL-2 0.23 qm x 408.00 €/qm = €94.00

Extra charge: €94.00

Note: Exchanges to a lower price group will not result in a reimbursement of the price difference.

The deliverability of the replacement front and the availability of the handle versions must be checked in advance.

per m <sup>2</sup> , W x H	60	254	363	468	633	1101	1222	-	
<b>MP-FLDXL-10</b>	-	60	254	363	468	633	1101	1222	-
per m <sup>2</sup> , W x H	-	-	194	303	408	573	1041	1162	-
<b>MP-FLDXL-20</b>	-	-	194	303	408	573	1041	1162	-
per m <sup>2</sup> , W x H	-	-	-	109	214	379	847	968	-
<b>MP-FLDXL-30</b>	-	-	-	109	214	379	847	968	-
per m <sup>2</sup> , W x H	-	-	-	-	105	270	738	859	-
<b>MP-FLDXL-40</b>	-	-	-	-	105	270	738	859	-
per m <sup>2</sup> , W x H	-	-	-	-	-	165	633	754	-
<b>MP-FLDXL-50</b>	-	-	-	-	-	165	633	754	-
per m <sup>2</sup> , W x H	-	-	-	-	-	-	468	589	-
<b>MP-FLDXL-60</b>	-	-	-	-	-	-	468	589	-
per m <sup>2</sup> , W x H	-	-	-	-	-	-	-	121	-
<b>MP-FLDXL-70</b>	-	-	-	-	-	-	-	121	-

### Additional equipment

Order no.  
W H D

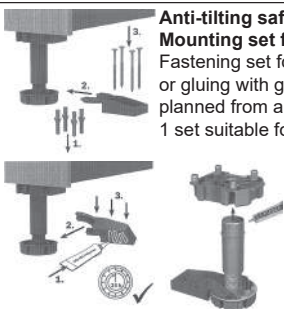
Decor groups								
M10	M20	M30	M40	M50	M60	M70	M80	M90

Surcharge for bas cabinets with glass fronts inside and exterior in the same design available in decor groups: S/B/H/MP/F/Z

<b>IDF-U</b>	-	-	-	802	-	802	802	-
--------------	---	---	---	-----	---	-----	-----	---

M 10	M 20	M 30	M 40	M 50
Glass unit outer finish K M10 laminate				B M50 Velvet lacquer S M50 microstructure lacquer
M 60	M 70	M 80	M 90	
		F M70 veneer / oak / walnut Z M70 Veneer / Bavaria		H M80 high gloss-Lacquer MP M80 laqué mat Premium

### Additional equipment



**Anti-tilting safety device**  
**Mounting set for base units**  
Fastening set for base cabinets for screwing or gluing with glue for floor mounting, can be planned from a plinth height of 10 cm  
1 set suitable for 1 base unit

<b>KS</b>	39							
-----------	----	--	--	--	--	--	--	--

**Note:**  
Mounting hardware is not included in the scope of delivery and must therefore be obtained by the customer.  
Base units - whether standing against the wall or used in island form - must also be secured in place to prevent them from toppling over.  
Attention: Gluing on laminate, PVC and linoleum floors is not permitted!  
For free-standing base units, KS-U is added automatically.

# 3.1

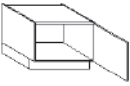
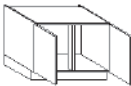
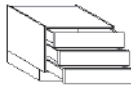
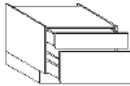
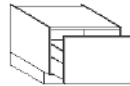
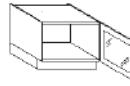
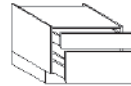
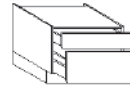
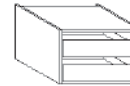
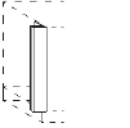


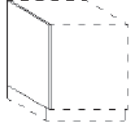
## Base units 39 cm, 52 cm, 65 cm high

Base units 39 cm high	XL 3.1.1	<b>Legend:</b>  Available with grip ledge N...  Not available with grip ledge N...  This symbol indicates which models are available  This symbol indicates which models are not available  wall-mounted units  available depths for wall-mounted units  Planning advice  Merchandise net  Not available with „push-to-open“ fitting  Available carcass depths 34/45.5/55.5/61.0 cm  Available carcass depths 45.5/55.5/61.0 cm  Available carcass depths 55.5/61.0 cm
Base units with glass door 39 cm high neutral	XL 3.1.1-XL 3.1.2	
Hob base units 39 cm high	XL 3.1.2	
Base shelf units 39 cm high	XL 3.1.2	
Front filler 39 cm high	XL 3.1.3	
Corner filler 39 cm high	XL 3.1.3	
Visible sides / increased side depth 39 cm high	XL 3.1.3	
Base units 52 cm high	XL 3.1.4	
Base units with glass door 52 cm high neutral	XL 3.1.5	
Hob base units 52 cm high	XL 3.1.5	
Sink carcasses 52 cm high	XL 3.1.5	
Front filler 52 cm high	XL 3.1.6	
Corner filler 52 cm high	XL 3.1.6	
Visible sides / increased side depth 52 cm high	XL 3.1.6	
Base units 65 cm high	XL 3.1.7-XL 3.1.8	
Base units as pass-throughs 65 cm high	XL 3.1.8	
Oven housings 65 cm high	XL 3.1.8	
Hob base units 65 cm high	XL 3.1.9	
Sink carcasses 65 cm high	XL 3.1.9-XL 3.1.11	
Fronts for electrical appliances 65 cm high	XL 3.1.11-XL 3.1.12	
Corner base units 65 cm high	XL 3.1.13	
Base shelf units 65 cm high	XL 3.1.14	
Background filler 65 cm high	XL 3.1.14	
Front filler 65 cm high	XL 3.1.14	
Corner filler 65 cm high	XL 3.1.15	
Back cladding 65 cm high with screw-fitted fronts	XL 3.1.15	
Support panel 65 cm high	XL 3.1.16	
Back cladding 65 cm high	XL 3.1.16	
Visible sides / increased side depth 65 cm high	XL 3.1.16	

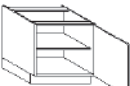
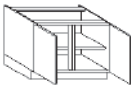
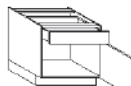
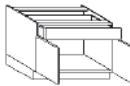
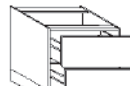
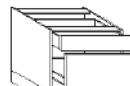
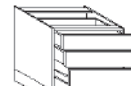
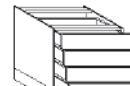
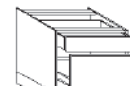
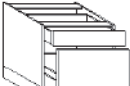
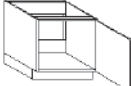

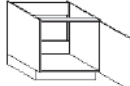
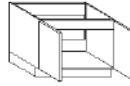
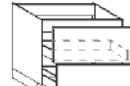



Heights  
39, 52,  
65 cm



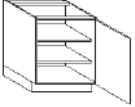
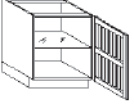

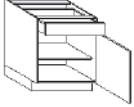
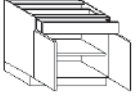
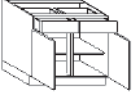
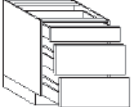
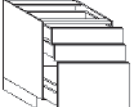
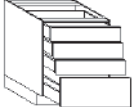
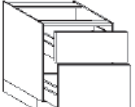
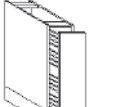
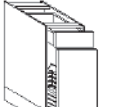

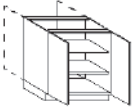
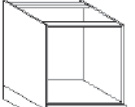
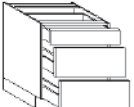
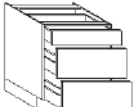
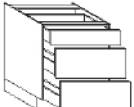
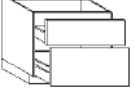
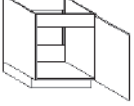
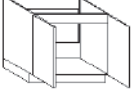
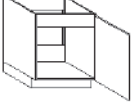
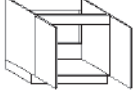
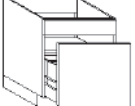
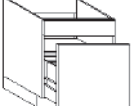
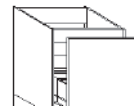
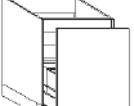
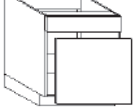
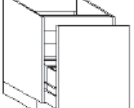
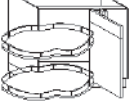

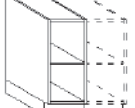
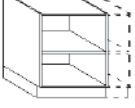


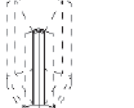
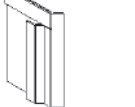
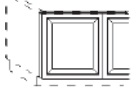
# The most important base unit models 39 cm high

Page XL 3.1.1	Page XL 3.1.1	Page XL 3.1.1	Page XL 3.1.1	Page XL 3.1.1	Page XL 3.1.1	Page XL 3.1.2	Page XL 3.1.2	Page XL 3.1.2
								
<b>U..395570</b> Unit widths: 30/40/45/50/60	<b>U..395570</b> Unit widths: 80/90/100/120	<b>U..395530</b> Unit widths: 30/40/45/50/60 70/80/90/100/120	<b>U..395511</b> Unit widths: 30/40/45/50/60 70/80/90/100/120	<b>U..395501</b> Unit widths: 30/40/45/50/60 70/80/90/100/120	<b>UGD..3955</b> Unit widths: 45/50/60	<b>UKI..395511</b> Unit widths: 60/80/90/100/120	<b>UKI..39554</b> Unit widths: 60/80/90/100/120	<b>URIF..3958IS2K</b> Unit widths: 45/60/90
Page XL 3.1.3	Page XL 3.1.3	Page XL 3.1.3	Page XL 3.1.3					
								
<b>UP..39</b> Unit widths: 3,5-20	<b>UPW..39</b> Unit widths: 65x65/75x75	<b>UPWN..39</b> Unit widths: 65x65/75x75	<b>USV..</b> Unit widths:					

# The most important base unit models 52 cm high

Page XL 3.1.4	Page XL 3.1.4	Page XL 3.1.4	Page XL 3.1.4	Page XL 3.1.4	Page XL 3.1.4	Page XL 3.1.4	Page XL 3.1.4	Page XL 3.1.5
								
<b>U..525570</b> Unit widths: 30/40/45/50/60	<b>U..525570</b> Unit widths: 80/90/100/120	<b>U..525510</b> Unit widths: 30/40/45/50/60	<b>U..525510</b> Unit widths: 80/90/100/120	<b>U..525502</b> Unit widths: 30/40/45/50/60 70/80/90/100/120	<b>U..525511</b> Unit widths: 30/40/45/50/60 70/80/90/100/120	<b>U..525521</b> Unit widths: 30/40/45/50/60 70/80/90/100/120	<b>U..525540</b> Unit widths: 30/40/45/50/60 70/80/90/100/120	<b>UKI.525511</b> Unit widths: 60/80/90/100/120
Page XL 3.1.5	Page XL 3.1.5	Page XL 3.1.5	Page XL 3.1.5	Page XL 3.1.5	Page XL 3.1.5	Page XL 3.1.6	Page XL 3.1.6	Page XL 3.1.6
								
<b>UKI.52554</b> Unit widths: 60/80/90/100/120	<b>US..5255701</b> Unit widths: 40/45/50/60	<b>US..5255701</b> Unit widths: 80/90/100/120	<b>US..5255702</b> Unit widths: 30/40/45/50/60	<b>US..5255702</b> Unit widths: 80/90/100/120	<b>US..5255026</b> Unit widths: 70/80/90/100/120	<b>UP..52</b> Unit widths: 3,5-20	<b>UPW..52</b> Unit widths: 65x65/75x75	<b>UPWN..52</b> Unit widths: 65x65/75x75

# The most important base unit models 65 cm high

Page XL 3.1.7	Page XL 3.1.7	Page XL 3.1.7	Page XL 3.1.7	Page XL 3.1.7	Page XL 3.1.7	Page XL 3.1.7	Page XL 3.1.7	Page XL 3.1.7
								
U..655570	SEU..655570	U..655570	U..655510	U..655510	U..655518	U..655512	U..655521	U..655531
Unit widths: 20/25/30/40/ 45/50/60	Unit widths: 60	Unit widths: 80/90/100/120	Unit widths: 30/40/45/50/60	Unit widths: 80/90/100/120	Unit widths: 80/90/100/120	Unit widths: 30/40/45/50/60 70/80/90/100/120	Unit widths: 30/40/45/50/60 70/80/90/100/120	Unit widths: 30/40/45/50/60 70/80/90/100/120
Page XL 3.1.8	Page XL 3.1.8	Page XL 3.1.8	Page XL 3.1.8	Page XL 3.1.8	Page XL 3.1.8	Page XL 3.1.9	Page XL 3.1.9	Page XL 3.1.9
								
U..655502	U..655507	U..655515	UDU..655570	UDU..655570	UH..655585	UKI..655512	UKI..65554	UKI..655541
Unit widths: 30/40/45/50/60 70/80/90/100/120	Unit widths: 15/20	Unit widths: 30/50	Unit widths: 45/50/60 80/90/100/120	Unit widths: 45/50/60 80/90/100/120	Unit widths: 60	Unit widths: 60/70/80/ 90/100/120	Unit widths: 60/80/90/100/120	Unit widths: 60/80/90/100/120
Page XL 3.1.9	Page XL 3.1.9	Page XL 3.1.9	Page XL 3.1.9	Page XL 3.1.9	Page XL 3.1.10	Page XL 3.1.10	Page XL 3.1.10	Page XL 3.1.11
								
UDK..6555028	US..6555701	US..6555701	US..6555702	US..6555702	US..655588	US..655581	US..6555881	US..6555811
Unit widths: 70/80/90/100/120	Unit widths: 40/45/50/60	Unit widths: 80/90/100/120	Unit widths: 30/40/45/50/60	Unit widths: 80/90/100/120	Unit widths: 30/40/45/50/60	Unit widths: 30/40/45/50/60	Unit widths: 30/40/45/50/60	Unit widths: 30/40/45/50/60
Page XL 3.1.11	Page XL 3.1.11	Page XL 3.1.13	Page XL 3.1.13	Page XL 3.1.14	Page XL 3.1.14	Page XL 3.1.14	Page XL 3.1.15	Page XL 3.1.15
								
US..655589	US..655579	UE..655564	UE..655574	UR..6558	UR..6558	UP..65	UPW..65	UPW..565
Unit widths: 45/50/60	Unit widths: 45/50/60	Unit widths: 110/115/125	Unit widths: 110/115/125	Unit widths: 30/40/45/50/60	Unit widths: 80/90	Unit widths: 3,5-20	Unit widths: 65x65/75x75	Unit widths: 105x105
Page XL 3.1.15	Page XL 3.1.15							
								
UPH..6552	UVF..65							
Unit widths: 65x65	Unit widths:							

## Base units 39 cm high

Carcase depth 55.5 cm (standard)

■ = Models also available in 34/45.5/61 cm carcise depth (Order no.: ... replace ... 55 ... with 34/45/61)  
 □ = Models also available in 45.5/61 cm carcise depth (order no.: replace ... 55 ... with 45/61)  
 ▲ = Types also available with 61 cm carcise depth (order no.: ... replace ... 55 ... with 61)

Order no.  
W H D

Hinge side: Carcise depth	Price groups											
	1	2	3	4	5	6	7	8	9			
386 34,0 45,5 55,5 61,0	■	U 30 39 55 70	R/L	161	165	181	210	230	240	251	276	-
		U 40 39 55 70	R/L	161	165	181	210	230	240	251	276	-
		U 45 39 55 70	R/L	161	165	181	210	230	240	251	276	-
		U 50 39 55 70	R/L	161	165	181	210	230	240	263	289	-
		U 60 39 55 70	R/L	165	172	192	231	251	263	286	315	-
386 34,0 45,5 55,5 61,0	■	U 80 39 55 70		205	213	236	338	377	398	427	470	-
		U 90 39 55 70		205	213	236	338	385	409	441	485	-
		U 100 39 55 70		211	220	245	346	399	413	448	493	-
		U 120 39 55 70		261	271	308	407	440	460	499	549	-
126 126 126	34,0 45,5 55,5 61,0	U 30 39 55 30		360	367	393	453	453	467	508	559	-
		U 40 39 55 30		360	367	393	453	453	467	508	559	-
		U 45 39 55 30		360	367	393	453	453	467	508	559	-
		U 50 39 55 30		360	367	393	453	453	467	508	559	-
		U 60 39 55 30		381	390	414	481	481	498	549	604	-
		U 70 39 55 30		578	588	647	703	713	746	815	897	-
		U 80 39 55 30		578	588	647	703	713	746	815	897	-
		U 90 39 55 30		578	588	647	703	713	746	815	897	-
		U 100 39 55 30		610	624	688	746	758	794	867	954	-
		U 120 39 55 30		639	657	728	790	800	846	923	1015	-
126 256	34,0 45,5 55,5 61,0	U 30 39 55 11		393	393	411	449	463	484	537	591	-
		U 40 39 55 11		393	393	411	449	463	484	537	591	-
		U 45 39 55 11		393	393	411	449	463	484	537	591	-
		U 50 39 55 11		393	393	411	449	463	484	537	591	-
		U 60 39 55 11		411	412	432	480	490	518	571	628	-
		U 70 39 55 11		572	578	618	678	695	734	813	894	-
		U 80 39 55 11		572	578	618	678	695	734	813	894	-
		U 90 39 55 11		572	578	618	678	695	734	813	894	-
		U 100 39 55 11		582	586	630	690	709	750	831	914	-
		U 120 39 55 11		589	599	647	704	723	769	850	935	-
386	34,0 45,5 55,5 61,0	U 30 39 55 01		252	255	280	314	314	325	357	393	-
		U 40 39 55 01		252	255	280	314	314	325	357	393	-
		U 45 39 55 01		252	255	280	314	314	325	357	393	-
		U 50 39 55 01		252	255	280	314	314	325	357	393	-
		U 60 39 55 01		269	275	302	341	341	360	391	430	-
		U 70 39 55 01		431	440	488	540	547	576	633	696	-
		U 80 39 55 01		431	440	488	540	547	576	633	696	-
		U 90 39 55 01		431	440	488	540	547	576	633	696	-
		U 100 39 55 01		441	448	500	552	560	594	651	716	-
		U 120 39 55 01		448	462	516	566	576	610	668	735	-
386	NEW	UB 45 39 55 01		391	396	419	448	467	477	494	543	-
		UB 50 39 55 01		392	396	419	448	473	481	501	551	-
		UB 60 39 55 01		398	402	423	462	479	491	515	567	-
		UB 70 39 55 01		467	477	499	546	601	617	652	717	-
		UB 80 39 55 01		467	477	499	546	601	617	652	717	-
		UB 90 39 55 01		467	477	499	546	601	617	652	717	-
126		U 30 13 55 10		178	181	194	237	237	250	268	295	-
		U 40 13 55 10		178	181	194	237	237	250	268	295	-
		U 45 13 55 10		178	181	194	237	237	250	268	295	-
		U 50 13 55 10		178	181	194	237	237	250	268	295	-
		U 60 13 55 10		178	181	194	237	237	250	268	295	-
		U 70 13 55 10		250	257	277	340	340	357	386	425	-
		U 80 13 55 10		250	257	277	340	340	357	386	425	-
		U 90 13 55 10		250	257	277	340	340	357	386	425	-
		U 100 13 55 10		278	288	310	371	371	385	418	460	-
		U 120 13 55 10		294	299	322	389	389	403	436	480	-

## Base units with glass door 39 cm high neutral

Carcise depth 55.5 cm (standard)

■ = Models also available in 34/45.5/61 cm carcise depth (Order no.: ... replace ... 55 ... with 34/45/61)  
 □ = Models also available in 45.5/61 cm carcise depth (order no.: replace ... 55 ... with 45/61)  
 ▲ = Types also available with 61 cm carcise depth (order no.: ... replace ... 55 ... with 61)

Order no.  
W H D

Hinge side: Carcise depth	Glass groups						
	G1	G2	G2S	G5S	G6		
386	NEW	UGD 45 39 55	-	-	410	-	792
		UGD 50 39 55	-	-	426	-	815
		UGD 60 39 55	-	-	473	-	851

## Base units with glass door 39 cm high neutral

Carcase depth 55.5 cm (standard)

- = Models also available in 34/45.5/61 cm carcass depth (Order no.: ... replace ... 55 ... with 34/45/61)
- = Models also available in 45.5/61 cm carcass depth (order no.: replace ... 55 ... with 45/61)
- ▲ = Types also available with 61 cm carcass depth (order no. ... replace ... 55 ... with 61)

Order no.  
W H D

Hinge side:	Carcass depth	Glass groups					
		G1	G2	G2S	G5S	G6	
		<b>G1 AKTIVglass frame</b> 991 Matt glass 992 Translucent black glass					
		<b>G2 Design front</b> 925 Frame White Agate/Matt glass 935 Premium W. Frame/Matt Glass 940 Macaron Col. Frame/Matt Glass 95 Light grey frame/matt glass 96 Silver Col. Frame/Matt Glass 960 Snow White Frame/Matt Glass 97 Black frame/black glass					
		<b>G2S aluminium, framed glass door</b> 988 aluminium black, Linea glass 994 Aluminium frame/clear glass 995 aluminium frame/black glass					
		<b>G5</b>					
		<b>G5S aluminium, door with mullion</b> 996 Alum.frame/clear gl./cross bar					
		<b>G6 NEW SALON</b> 986 aluminium black, black glass 987 aluminium black, clear glass 989 aluminium matt, bronze-coloured black glass 990 aluminium matt, bronze-coloured clear glass					

## Hob base units 39 cm high

Carcass depth 55.5 cm (standard)

- ▲ = Types also available with 61 cm carcass depth (order no. ... replace ... 55 ... with 61)

Order no.  
W H D

Hinge side:	Carcass depth	Price groups														
		1	2	3	4	5	6	7	8	9						
		<b>Hob base unit</b> With top shelf 1 drawer 12.6 cm with low frame 1 cable protective shelf 1 pull-out 25.6 cm														
		UKI	60	39	55	11	▲	527	531	568	630	643	657	710	781	-
		UKI	80	39	55	11	▲	805	810	885	969	978	1027	1126	1239	-
		UKI	90	39	55	11	▲	805	810	885	969	978	1027	1126	1239	-
		UKI	100	39	55	11	▲	820	832	907	992	1003	1056	1152	1267	-
		UKI	120	39	55	11	▲	842	851	931	1021	1027	1082	1185	1304	-
		<i>Important! Please follow the fitting instructions from the appliance manufacturers.</i>														
		<b>Hob base unit for induction hobs</b> With top shelf 1 drawer 12.6 cm with low frame 1 heat shield 1 pull-out 25.6 cm														
		UKI	60	39	55	4	▲	606	610	648	710	722	738	790	869	-
		UKI	80	39	55	4	▲	906	912	986	1070	1080	1130	1225	1348	-
		UKI	90	39	55	4	▲	912	919	991	1075	1087	1135	1231	1354	-
		UKI	100	39	55	4	▲	944	956	1031	1116	1127	1179	1276	1404	-
		UKI	120	39	55	4	▲	988	997	1079	1170	1176	1229	1333	1466	-
		<i>Important! Please follow the fitting instructions from the appliance manufacturers.</i>														

## Base shelf units 39 cm high

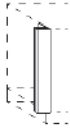

Carcass depth 57.7 cm, flush with front

- = Models also available in 36.1/47.7/63.2 cm carcass depth (Order no.: replace ... 58 ... with 36/48/63)



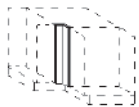


	<b>Base shelf unit 45 cm</b> 2 drawers with inset front Carcass depth 57.7 cm	36.1 47.7 57.7 63.2 PTO	URIF	45	39	58	IS2K	■	420	422	426	479	537	549	566	623	-
			URIF	45	39	58	IS2B	■	797	800	805	856	916	926	944	1038	-
			URIF	45	39	58	IS2S	■	797	800	805	856	916	926	944	1038	-
			URIF	45	39	58	IS2F	■	797	800	805	856	916	926	944	1038	-
			URIF	45	39	58	IS2Z	■	797	800	805	856	916	926	944	1038	-
	<b>Base shelf unit 60 cm</b> 2 drawers with inset front Carcass depth 57.7 cm	36.1 47.7 57.7 63.2 PTO	URIF	60	39	58	IS2K	■	434	436	444	501	562	591	617	679	-
			URIF	60	39	58	IS2B	■	812	814	824	879	940	970	994	1093	-
			URIF	60	39	58	IS2S	■	812	814	824	879	940	970	994	1093	-
			URIF	60	39	58	IS2F	■	812	814	824	879	940	970	994	1093	-
			URIF	60	39	58	IS2Z	■	812	814	824	879	940	970	994	1093	-
	<b>Base shelf unit 90 cm</b> 2 drawers with inset front Carcass depth 57.7 cm	36.1 47.7 57.7 63.2 PTO	URIF	90	39	58	IS2K	■	506	516	524	594	658	700	728	801	-
			URIF	90	39	58	IS2B	■	1111	1121	1129	1199	1265	1304	1335	1469	-
			URIF	90	39	58	IS2S	■	1111	1121	1129	1199	1265	1304	1335	1469	-
			URIF	90	39	58	IS2F	■	1111	1121	1129	1199	1265	1304	1335	1469	-
			URIF	90	39	58	IS2Z	■	1111	1121	1129	1199	1265	1304	1335	1469	-
Not available for: ALU TEC RP, ALUELEMENTS, ATLANTA-B, ATLANTA-S, BERGEN, CASTELLO, CHALET-B, CHALET-S, CHICAGO, FRAME, GENT, INTARSIA, LUGANO, LUX-B, MIAMI, NOBEL-B, NOBEL-S, OPAL-H, ORLANDO-B, ORLANDO-S, OSLO 15, PALERMO-B, PALERMO-S, ROMA-B, ROMA-S, SOFIE-B, SOFIE-S, STRIP ELEMENTS, TALEA, TESSIN 15, TIM 15, VILLAGE 15-B, VILLAGE 15-S, VINO, VIVA, YORK-B, YORK-S																	

<b>M 10</b>	<b>M 20</b>	<b>M 30</b>	<b>M 40</b>	<b>M 50</b>
K M10 laminate				B M50 Velvet Lacquer S M50 Microstructure Lacquer
<b>M 60</b>	<b>M 70</b>	<b>M 80</b>	<b>M 90</b>	
	F M70 veneer / oak / walnut Z M70 Veneer / Bavaria			

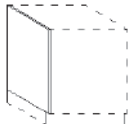

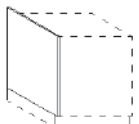

# Front filler 39 cm high

				Price groups										
		Order no. W H D		Hinge side:	Carcass depth	1	2	3	4	5	6	7	8	9
 <p><b>Base unit front filler</b> 3.5 - 10 cm 10.1 - 20 cm</p>		<b>UP</b>	<b>10 39</b>			50	50	53	71	71	71	75	83	-
		<b>UP</b>	<b>20 39</b>			60	60	63	88	88	88	98	108	-
<p><b>Base unit intermediate filler</b> 3.5 - 20 cm</p>		<b>UPZ</b>	<b>20 39</b>			55	55	57	84	84	84	93	102	-
		 <b>Not available for:</b> MIAMI, VIVA												

# Corner filler 39 cm high

 <p><b>Base unit corner filler 90°</b> 9.5 x 9.5 cm up to 20 x 20 cm</p>		 <b>Important!</b> Planning dimensions 65 x 65 cm Items can only be fitted in the ALU TEC RP models with a minimum size of 6 x 6 cm.												
		<b>UPW</b>	<b>65 39</b>			88	88	103	117	117	117	128	141	-
		<b>UPW</b>	<b>75 39</b>			98	98	110	123	123	123	159	175	-
 <p><b>Base unit corner filler 90° with grip ledge N700/775</b> 9.5 x 9.5 cm up to 20 x 20 cm</p> 		 <b>Important!</b> Planning dimensions 65 x 65 cm												
		<b>UPWN</b>	<b>65 39</b>			88	88	103	117	117	117	128	141	-
				Extra charge for N...			62	62	62	62	62	62	62	62
		<b>UPWN</b>	<b>75 39</b>			98	98	110	123	123	123	159	175	-
				Extra charge for N...			62	62	62	62	62	62	62	

# Visible sides / increased side depth 39 cm high

		Order no. W H D		Hinge side:	Carcass depth	Decor groups								
						M10	M20	M30	M40	M50	M60	M70	M80	M90
 <p><b>Base unit visible side</b> 55.5 cm side depth Fixed dimension, not variable 57.5 cm side depth Fixed dimension, not variable 60.5 cm side depth Fixed dimension, not variable 61 cm side depth Fixed dimension, not variable 70.5 cm side depth Fixed dimension, not variable</p>		 <b>Important!</b> Installation instead of a normal unit side. <b>Only available in the listed side depths.</b> For other dimensions, use USVT...												
		<b>USV</b>	<b>39</b>	R/L		0	0	63	63	83	83	94	123	-
		<b>USV</b>	<b>39 5</b>	R/L		0	0	63	63	83	83	94	123	-
		<b>USV</b>	<b>39 6</b>	R/L		0	0	63	63	83	83	94	123	-
		<b>USV</b>	<b>39 6 1</b>	R/L		0	0	63	63	83	83	94	123	-
		<b>USV</b>	<b>39 7</b>	R/L		0	0	63	63	83	83	94	123	-
 <p><b>Base unit increased side depth</b> from 61.1 cm up to 90 cm side depth Up to 60.9 cm side depth</p>		 <b>Important!</b> Installation instead of a normal unit side.												
		<b>USVT</b>	<b>39</b>	R/L		59	72	135	135	179	179	206	264	-
		<b>USVT</b>	<b>39 6</b>	R/L		32	35	89	89	119	119	138	180	-

M 10	M 20	M 30	M 40	M 50
K M10 laminate	D M20 Laminate decor	I M30 RESOPAL PRO super matt IH M30 HPL PRO PW M30 PRIMEWOOD/Basic Veneer	A M40 DIRECTLACK matt L M40 DIRECTLACK high-gloss	B M50 Velvet lacquer P M50 Soft lacquer RH M50 Velvet lacquer wood texture RW M50 Velvet lacquer spackle effect S M50 microstructure lacquer
M 60	M 70	M 80	M 90	
QH M60 SMARTGLAS high-gloss QM M60 SMARTGLAS satin-finish	F M70 veneer / oak / walnut V M70 Velvet lacquer textured Z M70 Veneer / Bavaria	C1 M80 FENIX stainless-steel look H M80 high gloss-Lacquer MP M80 laqué mat Premium O M80 Veneered		

# Base units 52 cm high

Carcase depth 55.5 cm (standard)

■ = Models also available in 34/45.5/61 cm carcise depth (Order no.: ... replace ... 55 ... with 34/45/61)  
 □ = Models also available in 45.5/61 cm carcise depth (order no.: replace ... 55 ... with 45/61)  
 ▲ = Types also available with 61 cm carcise depth (order no. ... replace ... 55 ... with 61)

Order no.  
 W H D

Hinge side:	Carcise depth	Price groups									
		1	2	3	4	5	6	7	8	9	
R/L	■	U 30 52 55 70	167	176	201	251	269	283	312	343	-
		U 40 52 55 70	167	176	201	255	269	288	316	348	-
		U 45 52 55 70	167	176	201	255	269	288	316	348	-
		U 50 52 55 70	167	176	201	255	288	311	347	382	-
		U 60 52 55 70	201	211	228	292	337	361	401	441	-
■	■	U 80 52 55 70	226	236	262	385	471	507	571	628	-
		U 90 52 55 70	226	236	262	385	471	507	571	628	-
		U 100 52 55 70	233	246	279	402	465	502	571	628	-
		U 120 52 55 70	270	288	330	483	550	601	679	747	-
R/L	■	U 30 52 55 10	216	223	250	310	325	346	375	413	-
		U 40 52 55 10	216	223	250	311	325	349	377	415	-
		U 45 52 55 10	216	223	250	311	339	359	390	429	-
		U 50 52 55 10	216	223	250	311	339	361	395	435	-
R/L	■	U 60 52 55 10	245	254	286	351	378	406	444	488	-
■	■	U 80 52 55 10	300	314	340	477	534	569	639	703	-
		U 90 52 55 10	300	314	340	477	534	569	639	703	-
		U 100 52 55 10	303	317	351	485	541	581	648	713	-
		U 120 52 55 10	311	325	360	498	552	595	663	729	-
Width 80, 100 Not available for: GENT, INTARSIA, OSLO 15, TESSIN 15, TIM 15, VILLAGE 15-B, VILLAGE 15-S Width 90, 120 Not available for: INTARSIA											
■	■	U 30 52 55 02	426	436	485	536	536	559	597	657	-
		U 40 52 55 02	426	436	485	536	536	559	597	657	-
		U 45 52 55 02	426	436	485	536	536	559	597	657	-
		U 50 52 55 02	426	436	485	536	536	559	608	669	-
		U 60 52 55 02	461	471	517	582	582	615	666	733	-
		U 70 52 55 02	736	749	834	917	932	983	1080	1188	-
		U 80 52 55 02	736	749	834	917	932	983	1080	1188	-
		U 90 52 55 02	736	749	834	917	932	983	1080	1188	-
		U 100 52 55 02	756	772	856	943	956	1012	1110	1221	-
U 120 52 55 02	773	790	881	971	981	1038	1141	1255	-		
■	■	U 30 52 55 11	426	436	485	536	536	559	597	657	-
		U 40 52 55 11	426	436	485	536	536	559	597	657	-
		U 45 52 55 11	426	436	485	536	536	559	597	657	-
		U 50 52 55 11	426	436	485	536	536	559	608	669	-
		U 60 52 55 11	461	471	517	582	582	615	666	733	-
		U 70 52 55 11	736	749	834	917	932	983	1080	1188	-
		U 80 52 55 11	736	749	834	917	932	983	1080	1188	-
		U 90 52 55 11	736	749	834	917	932	983	1080	1188	-
		U 100 52 55 11	756	772	856	943	956	1012	1110	1221	-
U 120 52 55 11	773	790	881	971	981	1038	1141	1255	-		
■	■	U 30 52 55 21	461	467	518	566	566	588	639	703	-
		U 40 52 55 21	461	467	518	566	566	588	639	703	-
		U 45 52 55 21	461	467	518	566	566	588	639	703	-
		U 50 52 55 21	461	467	518	566	566	588	639	703	-
		U 60 52 55 21	492	499	548	616	616	644	700	770	-
		U 70 52 55 21	769	782	865	948	962	1014	1110	1221	-
		U 80 52 55 21	769	782	865	948	962	1014	1110	1221	-
		U 90 52 55 21	769	782	865	948	962	1014	1110	1221	-
		U 100 52 55 21	793	812	900	987	1001	1057	1156	1272	-
U 120 52 55 21	820	844	934	1025	1038	1098	1203	1323	-		
■	■	U 30 52 55 40	461	476	491	562	579	602	639	703	-
		U 40 52 55 40	461	476	491	562	579	602	639	703	-
		U 45 52 55 40	461	476	491	562	579	602	639	703	-
		U 50 52 55 40	461	476	491	562	579	602	639	703	-
		U 60 52 55 40	480	488	505	587	607	637	677	745	-
		U 70 52 55 40	797	814	897	979	992	1044	1142	1256	-
		U 80 52 55 40	797	814	897	979	992	1044	1142	1256	-
		U 90 52 55 40	797	814	897	979	992	1044	1142	1256	-
		U 100 52 55 40	832	854	943	1029	1044	1100	1203	1323	-
U 120 52 55 40	865	895	990	1080	1094	1154	1264	1390	-		



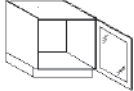
## Base units with glass door 52 cm high neutral

Carcase depth 55.5 cm (standard)

■ = Models also available in 34/45.5/61 cm carcass depth (Order no.: ... replace ... 55 ... with 34/45/61)  
 □ = Models also available in 45.5/61 cm carcass depth (order no.: replace ... 55 ... with 45/61)  
 ▲ = Types also available with 61 cm carcass depth (order no.: ... replace ... 55 ... with 61)

Order no.  
W H D

Hinge side:	Carcass depth	Price groups				
		G1	G2	G2S	G5S	G6
■		-	-	415	-	796
■		-	-	431	-	819
■		-	-	478	-	855

**516**  **Base unit with glass front**  
 -neutral-  
 1 glass door 51.6 cm  
 1 adjustable glass shelf

**NEW**

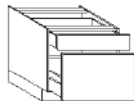
UGD	45	52	55
UGD	50	52	55
UGD	60	52	55

G 1	G 2	G 2S	G 5	G 5S	G 6
<b>G1 AKTIVglass frame</b> 991 Matt glass 992 Translucent black glass	<b>G2 Design front</b> 925 Frame White Agate/Matt glass 935 Premium W. Frame/Matt Glass 940 Macaron Col. Frame/Matt Glass 95 Light grey frame/matt glass 96 Silver Col. Frame/Matt Glass 960 Snow White Frame/Matt Glass 97 Black frame/black glass	<b>G2S aluminium, framed glass door</b> 988 aluminium black, Linea glass 994 Aluminium frame/clear glass 995 aluminium frame/black glass			
<b>G 5</b>	<b>G 5S</b> G5S aluminium, door with mullion 996 Alum.frame/clear gl./cross bar	<b>G 6</b> <b>G6 NEW SALON</b> 986 aluminium black, black glass 987 aluminium black, clear glass 989 aluminium matt, bronze-coloured black glass 990 aluminium matt, bronze-coloured clear glass			


## Hob base units 52 cm high

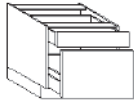
Carcass depth 55.5 cm (standard)

▲ = Types also available with 61 cm carcass depth (order no.: ... replace ... 55 ... with 61)


**126**  **Hob base unit**  
 1 drawer 12.6 cm  
 with low frame  
 1 cable protective shelf  
 1 pull-out 38.6 cm

UKI	60	52	55	11	▲	535	546	593	655	655	689	740	814	-
UKI	80	52	55	11	▲	812	826	909	990	1008	1058	1153	1268	-
UKI	90	52	55	11	▲	812	826	909	990	1008	1058	1153	1268	-
UKI	100	52	55	11	▲	830	848	931	1017	1029	1085	1184	1302	-
UKI	120	52	55	11	▲	849	865	957	1044	1056	1112	1216	1338	-

**Note:**  
 Please follow the fitting instructions from the appliance manufacturers.

**126**  **Hob base unit for induction hobs**  
 1 drawer 12.6 cm  
 with low frame  
 1 heat shield  
 1 pull-out 38.6 cm


UKI	60	52	55	4	▲	615	625	671	736	736	769	820	902	-
UKI	80	52	55	4	▲	913	926	1012	1092	1109	1159	1256	1382	-
UKI	90	52	55	4	▲	920	932	1018	1098	1114	1166	1262	1388	-
UKI	100	52	55	4	▲	954	971	1056	1140	1152	1208	1307	1438	-
UKI	120	52	55	4	▲	995	1014	1106	1193	1202	1259	1361	1497	-

**Note:**  
 Please follow the fitting instructions from the appliance manufacturers.


## Sink carcasses 52 cm high

Carcass depth 55.5 cm (standard)

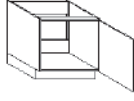
□ = Models also available in 45.5/61 cm carcass depth (order no.: replace ... 55 ... with 45/61) ▲ = Types also available with 61 cm carcass depth (order no.: ... replace ... 55 ... with 61)

**516**  **Sink carcass**  
 1 door 51.6 cm  
 1 aluminium protective shelf

US	40	52	55	701	R/L	▲	199	214	229	287	322	340	374	411	-
US	45	52	55	701	R/L	▲	199	214	229	287	322	340	374	411	-
US	50	52	55	701	R/L	▲	204	215	230	288	323	349	378	416	-
US	60	52	55	701	R/L	▲	231	246	267	331	368	389	430	473	-

**516**  **Sink carcass**  
 2 doors 51.6 cm  
 Left door with buffer strip  
 Without centre panel  
 1 aluminium protective shelf

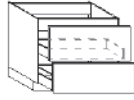
US	80	52	55	701	▲	267	280	308	440	507	547	610	671	-
US	90	52	55	701	▲	269	285	311	442	509	550	616	678	-
US	100	52	55	701	▲	287	299	329	472	515	553	620	682	-
US	120	52	55	701	▲	326	346	389	542	588	637	716	788	-

**516**  **Sink carcass**  
 1 door 51.6 cm

US	30	52	55	702	R/L	□	176	188	207	261	299	319	354	389	-
US	40	52	55	702	R/L	□	176	188	207	261	299	319	354	389	-
US	45	52	55	702	R/L	□	176	188	207	261	299	319	354	389	-
US	50	52	55	702	R/L	□	176	188	207	261	299	322	359	395	-
US	60	52	55	702	R/L	□	207	218	239	304	340	364	403	443	-

**516**  **Sink carcass**  
 2 doors 51.6 cm  
 Left door with buffer strip  
 Without centre panel

US	80	52	55	702	□	230	245	270	407	474	509	573	630	-
US	90	52	55	702	□	230	245	270	407	474	509	577	635	-
US	100	52	55	702	□	244	257	288	427	474	509	578	636	-
US	120	52	55	702	□	280	302	342	496	547	595	669	736	-

**256**  **Sink carcass**  
 1 pull-out 25.6 cm, 45.5 cm deep  
 with full-width panel  
 with wooden rear panel reduced in height  
 1 moulded part for drain set  
 1 pull-out 25.6 cm  
 with full-width panel



US	70	52	55	026	▲	873	894	979	1006	1021	1070	1174	1291	-
US	80	52	55	026	▲	873	894	979	1006	1021	1070	1174	1291	-
US	90	52	55	026	▲	873	894	979	1006	1021	1070	1174	1291	-
US	100	52	55	026	▲	893	912	1004	1029	1044	1101	1203	1323	-
US	120	52	55	026	▲	917	943	1039	1068	1082	1141	1253	1378	-

**Extra charge Sink carcass with full back panel**






SA50SVR	34
---------	----



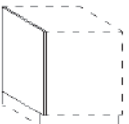

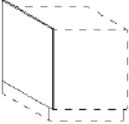

## Front filler 52 cm high

			Price groups										
Order no. W H D			Hinge side:	Carcase depth	1	2	3	4	5	6	7	8	9
 <b>Base unit front filler</b> 3.5 - 10 cm 10.1 - 20 cm	<b>UP 10 52</b>				50	50	53	71	71	71	75	83	-
	<b>UP 20 52</b>				60	60	63	88	88	88	98	108	-
<b>Base unit intermediate filler</b> 3.5 - 20 cm	<b>UPZ 20 52</b>				60	60	64	88	88	88	98	108	-
	 <b>Not available for:</b> MIAMI, VIVA												

## Corner filler 52 cm high

 <b>Base unit corner filler 90°</b> 9.5 x 9.5 cm up to 20 x 20 cm	 <b>Important!</b> Planning dimensions 65 x 65 cm Items can only be fitted in the ALU TEC RP models with a minimum size of 6 x 6 cm.												
	<b>UPW 65 52</b>				88	88	103	117	117	117	128	141	-
	<b>UPW 75 52</b>					98	98	110	123	123	123	159	175
 <b>Base unit corner filler 90° with grip ledge N700/775</b> 9.5 x 9.5 cm up to 20 x 20 cm  	 <b>Important!</b> Planning dimensions 65 x 65 cm												
	<b>UPWN 65 52</b>				88	88	103	117	117	117	128	141	-
	Extra charge for N...												
	<b>UPWN 75 52</b>					98	98	110	123	123	123	159	175
Extra charge for N...													

## Visible sides / increased side depth 52 cm high

			Decor groups										
Order no. W H D			Hinge side:	Carcase depth	M10	M20	M30	M40	M50	M60	M70	M80	M90
 <b>Base unit visible side</b> 55.5 cm side depth Fixed dimension, not variable 57.5 cm side depth Fixed dimension, not variable 60.5 cm side depth Fixed dimension, not variable 61 cm side depth Fixed dimension, not variable 70.5 cm side depth Fixed dimension, not variable	 <b>Important! Installation instead of a normal unit side.</b> Only available in the listed side depths. For other dimensions, use USVT...												
	<b>USV 52</b>	R/L			0	0	63	63	83	83	94	123	-
	<b>USV 52 5</b>	R/L			0	0	63	63	83	83	94	123	-
	<b>USV 52 6</b>	R/L			0	0	63	63	83	83	94	123	-
	<b>USV 52 6 1</b>	R/L			0	0	63	63	83	83	94	123	-
	<b>USV 52 7</b>	R/L			0	0	63	63	83	83	94	123	-
 <b>Base unit increased side depth</b> from 61.1 cm up to 90 cm side depth Up to 60.9 cm side depth	 <b>Important!</b> Installation instead of a normal unit side.												
	<b>USVT 52</b>	R/L			59	72	135	135	179	179	206	264	-
	<b>USVT 52 6</b>	R/L			32	35	89	89	119	119	138	180	-

M 10	M 20	M 30	M 40	M 50
K M10 laminate	D M20 Laminate decor	I M30 RESOPAL PRO super matt IH M30 HPL PRO PW M30 PRIMEWOOD/Basic Veneer	A M40 DIRECTLACK matt L M40 DIRECTLACK high-gloss	B M50 Velvet lacquer P M50 Soft lacquer RH M50 Velvet lacquer wood texture RW M50 Velvet lacquer spackle effect S M50 microstructure lacquer
M 60	M 70	M 80	M 90	
QH M60 SMARTGLAS high-gloss QM M60 SMARTGLAS satin-finish	F M70 veneer / oak / walnut V M70 Velvet lacquer textured Z M70 Veneer / Bavaria	C1 M80 FENIX stainless-steel look H M80 high gloss-Lacquer MP M80 laqué mat Premium O M80 Veneered		

# Base units 65 cm high

Carcase depth 55.5 cm (standard)

■ = Models also available in 34/45.5/61 cm carcass depth (Order no.: ... replace ... 55 ... with 34/45/61)  
 □ = Models also available in 45.5/61 cm carcass depth (order no.: replace ... 55 ... with 45/61)  
 ▲ = Types also available with 61 cm carcass depth (order no.: ... replace ... 55 ... with 61)

Order no.  
 W H D

Hinge side:	Carcass depth	Price groups															
		1	2	3	4	5	6	7	8	9							
646	34,0 45,5 55,5 61,0		<b>Base unit</b>		R/L	■	1 door 64.6 cm	178	188	210	260	279	293	322	354	-	
			2 adjustable shelves				U 20 65 55 70	178	188	210	260	279	293	322	354	-	
			U 25 65 55 70	178			188	210	260	279	293	322	354	-			
			U 30 65 55 70	178			188	210	260	279	293	322	354	-			
			U 40 65 55 70	178			188	210	264	279	299	325	358	-			
			U 45 65 55 70	178			188	210	264	279	299	325	358	-			
			U 50 65 55 70	178			188	210	264	299	321	357	393	-			
			U 60 65 55 70	R/L	■	211	223	239	302	347	371	412	453	-			
width 20 cm: FRAME, VILLAGE 15-S, VILLAGE 15-B, CHALET-S, CHALET-B, OSLO 15, TESSIN 15, BERGEN, LUGANO, CASTELLO, VIVA, TIM 15 are supplied with smooth fronts. width 25 cm: FRAME are supplied with smooth fronts.																	
646	34,0 45,5 55,5 61,0		<b>Base unit</b>		R/L	■	1 door 64.6 cm	-	-	-	-	-	-	-	-	-	
			1 adjustable glass shelf				With „push to open“ fitting	SE U 60 65 55 70									1093
Available for: STRIP ELEMENTS Available finishes: 775 Ash black lacquered																	
646	34,0 45,5 55,5 61,0		<b>Base unit</b>			■	2 doors 64.6 cm	237	250	276	399	482	522	583	641	-	
			2 adjustable shelves				U 80 65 55 70	237	250	276	399	482	522	584	642	-	
			U 90 65 55 70	251			262	297	419	482	522	587	646	-			
			U 100 65 55 70	288			307	351	500	569	618	697	767	-			
			U 120 65 55 70														
126 516	34,0 45,5 55,5 61,0		<b>Base unit</b>		R/L	■	1 drawer 12.6 cm	227	233	259	320	335	356	385	424	-	
			1 door 51.6 cm				U 30 65 55 10	227	233	259	321	335	359	389	428	-	
			1 adjustable shelf				U 40 65 55 10	227	233	259	321	349	368	400	440	-	
			U 45 65 55 10	227			233	259	321	349	370	406	447	-			
			U 50 65 55 10	255			264	298	361	391	416	456	502	-			
			U 60 65 55 10	R/L	■	255	264	298	361	391	416	456	502	-			
126 516	34,0 45,5 55,5 61,0		<b>Base unit</b>			■	1 drawer 12.6 cm with full-width panel	312	325	353	488	546	581	650	715	-	
			2 doors 51.6 cm				U 80 65 55 10	312	325	353	488	546	581	650	715	-	
			1 adjustable shelf				U 90 65 55 10	321	334	367	501	558	598	664	730	-	
			Left door with buffer strip Without centre panel				U 100 65 55 10	329	345	376	517	570	612	682	750	-	
			U 120 65 55 10														
Width 80, 100 Not available for: GENT, INTARSIA, OSLO 15, TESSIN 15, TIM 15, VILLAGE 15-B, VILLAGE 15-S Width 90, 120 Not available for: INTARSIA																	
126 516	34,0 45,5 55,5 61,0		<b>Base unit</b>			■	2 drawers 12.6 cm	343	359	378	518	577	615	678	746	-	
			2 doors 51.6 cm				U 80 65 55 18	343	359	383	522	577	615	681	749	-	
			1 adjustable shelf				U 90 65 55 18	360	371	398	540	577	615	682	750	-	
			U 100 65 55 18	399			422	460	623	674	718	797	877	-			
			U 120 65 55 18														
126 256 256	34,0 45,5 55,5 61,0		<b>Base unit</b>			■	1 drawer 12.6 cm	461	467	518	566	566	588	639	703	-	
			2 pull-outs 25.6 cm				U 30 65 55 12	461	467	518	566	566	588	639	703	-	
			U 40 65 55 12	461			467	518	566	566	588	639	703	-			
			U 45 65 55 12	461			467	518	566	566	588	639	703	-			
			U 50 65 55 12	461			467	518	566	566	588	639	703	-			
			U 60 65 55 12	492			499	548	616	616	644	700	770	-			
			U 70 65 55 12	769			782	865	948	962	1014	1110	1221	-			
			U 80 65 55 12	769			782	865	948	962	1014	1110	1221	-			
			U 90 65 55 12	769			782	865	948	962	1014	1110	1221	-			
			U 100 65 55 12	793			812	900	987	1001	1057	1156	1272	-			
			U 120 65 55 12			820	844	934	1025	1038	1098	1203	1323	-			
126 126 386	34,0 45,5 55,5 61,0		<b>Base unit</b>			■	2 drawers 12.6 cm	461	467	518	566	566	588	639	703	-	
			1 pull-out 38.6 cm				U 30 65 55 21	461	467	518	566	566	588	639	703	-	
			U 40 65 55 21	461			467	518	566	566	588	639	703	-			
			U 45 65 55 21	461			467	518	566	566	588	639	703	-			
			U 50 65 55 21	461			467	518	566	566	588	639	703	-			
			U 60 65 55 21	492			499	548	616	616	644	700	770	-			
			U 70 65 55 21	769			782	865	948	962	1014	1110	1221	-			
			U 80 65 55 21	769			782	865	948	962	1014	1110	1221	-			
			U 90 65 55 21	769			782	865	948	962	1014	1110	1221	-			
			U 100 65 55 21	793			812	900	987	1001	1057	1156	1272	-			
			U 120 65 55 21			820	844	934	1025	1038	1098	1203	1323	-			
126 126 256	34,0 45,5 55,5 61,0		<b>Base unit</b>			■	3 drawers 12.6 cm	461	476	491	562	579	602	639	703	-	
			1 pull-out 25.6 cm				U 30 65 55 31	461	476	491	562	579	602	639	703	-	
			U 40 65 55 31	461			476	491	562	579	602	639	703	-			
			U 45 65 55 31	461			476	491	562	579	602	639	703	-			
			U 50 65 55 31	461			476	491	562	579	602	639	703	-			
			U 60 65 55 31	480			488	505	587	607	637	677	745	-			
			U 70 65 55 31	797			814	897	979	992	1044	1142	1256	-			
			U 80 65 55 31	797			814	897	979	992	1044	1142	1256	-			
			U 90 65 55 31	797			814	897	979	992	1044	1142	1256	-			
			U 100 65 55 31	832			854	943	1029	1044	1100	1203	1323	-			
			U 120 65 55 31			865	895	990	1080	1094	1154	1264	1390	-			

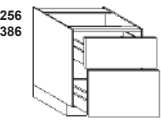
## Base units 65 cm high

Carcase depth 55.5 cm (standard)

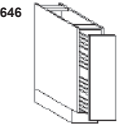
■ = Models also available in 34/45.5/61 cm carcass depth (Order no.: ... replace ... 55 ... with 34/45/61)  
 □ = Models also available in 45.5/61 cm carcass depth (order no.: replace ... 55 ... with 45/61)  
 ▲ = Types also available with 61 cm carcass depth (order no. ... replace ... 55 ... with 61)

Order no.  
W H D

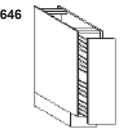
Hinge side:	Carcass depth	Price groups									
		1	2	3	4	5	6	7	8	9	
■	55.5	U 30 65 55 02	426	436	485	536	536	559	597	657	-
		U 40 65 55 02	426	436	485	536	536	559	597	657	-
		U 45 65 55 02	426	436	485	536	536	559	597	657	-
		U 50 65 55 02	426	436	485	536	536	559	608	669	-
		U 60 65 55 02	461	471	517	582	582	615	666	733	-
		U 70 65 55 02	736	749	834	917	932	983	1080	1188	-
		U 80 65 55 02	736	749	834	917	932	983	1080	1188	-
		U 90 65 55 02	736	749	834	917	932	983	1080	1188	-
		U 100 65 55 02	756	772	856	943	956	1012	1110	1221	-
U 120 65 55 02	773	790	881	971	981	1038	1141	1255	-		
▲	61.0	U 15 65 55 07	297	302	328	391	413	430	462	508	-
Not available for: MIAMI, VIVA Important! Available frame fronts are supplied with smooth fronts.											
▲	61.0	U 20 65 55 07	297	302	328	391	413	430	462	508	-
Not available for: BERGEN, LUGANO width 20 cm: FRAME, VILLAGE 15-S, VILLAGE 15-B, CHALET-S, CHALET-B, OSLO 15, TESSIN 15, BERGEN, LUGANO, CASTELLO, VIVA, TIM 15 are supplied with smooth fronts.											
▲	61.0	U 30 65 55 15	321	328	357	418	441	460	488	537	-
▲	61.0	U 50 65 55 15	357	366	390	464	479	505	540	594	-



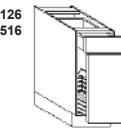
**Base unit**  
 1 pull-out 25.6 cm  
 1 pull-out 38.6 cm



**Base unit**  
 1 pull-out 64.6 cm  
 2 fixed-position baskets with metal base and chrome-plated, square-section rail



**Base unit**  
 1 pull-out 64.6 cm  
 2 fixed-position baskets with metal base and chrome-plated, square-section rail

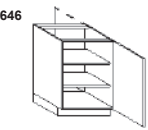


**Base unit bottle pull-out**  
 1 drawer 12.6 cm  
 1 pull-out 51.6 cm with  
 1 bottle basket (chrome-plated)  
 (with 50 cm width 2 bottle baskets)

## Base units as pass-throughs 65 cm high

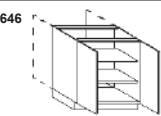
Carcass depth 55.5 cm (standard)

▲ = Types also available with 61 cm carcass depth (order no. ... replace ... 55 ... with 61)



**Base unit as pass-through**  
 1 door 64.6 cm  
 2 adjustable shelves

UDU 45 65 55 70	R/L ▲	204	215	241	304	320	345	373	410	-
UDU 50 65 55 70	R/L ▲	205	215	242	304	343	369	411	452	-
UDU 60 65 55 70	R/L ▲	244	255	276	349	400	426	474	521	-
Note: Door hinged front left = door hinged rear right. Always from the perspective of standing in front of the unit. Please order additional doors for the rear side.										



**Base unit as pass-through**  
 2 doors 64.6 cm  
 2 adjustable shelves

UDU 80 65 55 70	▲	276	286	316	458	554	599	669	736	-
UDU 90 65 55 70	▲	276	286	316	458	554	599	669	736	-
UDU 100 65 55 70	▲	282	296	332	482	552	604	678	746	-
UDU 120 65 55 70	▲	332	354	404	576	654	711	801	881	-
Note: Door hinged front left = door hinged rear right. Always from the perspective of standing in front of the unit. Please order additional doors for the rear side.										



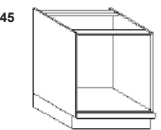
**Base unit door**  
 With fitting drill hole  
 Without fitting,  
 Height: 646 mm

E-TUO 20 65	R/L	50	52	65	94	116	165	181	199	-
E-TUO 25 65	R/L	52	57	73	105	133	178	194	213	-
E-TUO 30 65	R/L	54	68	84	116	140	183	204	224	-
E-TUO 40 65	R/L	63	85	105	137	181	226	249	274	-
E-TUO 45 65	R/L	66	93	112	146	199	236	260	286	-
E-TUO 50 65	R/L	70	105	123	159	216	258	286	315	-
E-TUO 60 65	R/L	75	122	143	179	249	308	340	374	-
width 20 cm: FRAME, VILLAGE 15-S, VILLAGE 15-B, CHALET-S, CHALET-B, OSLO 15, TESSIN 15, BERGEN, LUGANO, CASTELLO, VIVA, TIM 15 are supplied with smooth fronts. width 25 cm: FRAME are supplied with smooth fronts.										

## Oven housings 65 cm high

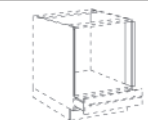
Carcass depth 55.5 cm (standard)

▲ = Types also available with 61 cm carcass depth (order no. ... replace ... 55 ... with 61)



**Oven housing**  
 1 fixed panel 4.5 cm

UH 60 65 55 85	▲	161	162	171	180	180	199	217	239	-
Note: When planning with induction hotplates please take into account the specifications of the manufacturer for the thickness of the worktop.										



**Heat shields**  
 to protect fronts adjacent to oven  
 silver-coloured  
 price per pair

HP/C		17,10									
------	--	-------	--	--	--	--	--	--	--	--	--

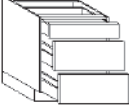

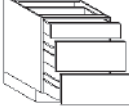

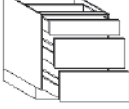

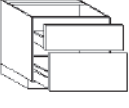

## Hob base units 65 cm high

Carcase depth 55.5 cm (standard)

		Price groups								
Hinge side:	Carcase depth	1	2	3	4	5	6	7	8	9

Order no.  
W H D

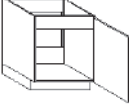

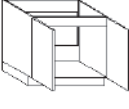

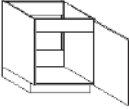

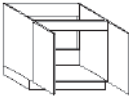

▲ = Types also available with 61 cm carcase depth (order no. ... replace ... 55 ... with 61)

126 256 256 	<b>Hob base unit</b> 1 drawer 12.6 cm with low frame 1 cable protective shelf 2 pull-outs 25.6 cm		UKI 60 65 55 12	▲	570	578	625	692	692	720	777	855	-
			UKI 70 65 55 12	▲	848	861	943	1026	1038	1090	1189	1308	-
			UKI 80 65 55 12	▲	848	861	943	1026	1038	1090	1189	1308	-
			UKI 90 65 55 12	▲	848	861	943	1026	1038	1090	1189	1308	-
			UKI 100 65 55 12	▲	872	893	977	1065	1078	1133	1235	1359	-
			UKI 120 65 55 12	▲	899	923	1014	1102	1115	1173	1282	1410	-
			Note: Please follow the fitting instructions from the appliance manufacturers.										
126 256 256 	<b>Hob base unit for induction hobs</b> 1 drawer 12.6 cm with low frame 1 heat shield 2 pull-outs 25.6 cm		UKI 60 65 55 4	▲	650	656	705	770	770	797	854	939	-
			UKI 80 65 55 4	▲	949	965	1044	1127	1137	1189	1289	1418	-
			UKI 90 65 55 4	▲	956	970	1050	1132	1143	1196	1294	1423	-
			UKI 100 65 55 4	▲	996	1015	1101	1186	1199	1254	1356	1492	-
			UKI 120 65 55 4	▲	1045	1071	1160	1248	1259	1317	1428	1571	-
			Note: Please follow the fitting instructions from the appliance manufacturers.										
126 256 256 	<b>Hob base unit for induction hobs</b> 1 drawer 12.6 cm with low frame 45.5 cm deep 1 heat shield 2 pull-outs 25.6 cm		UKI 60 65 55 41	▲	650	656	705	770	770	797	854	939	-
			UKI 80 65 55 41	▲	949	965	1044	1127	1137	1189	1289	1418	-
			UKI 90 65 55 41	▲	956	970	1050	1132	1143	1196	1294	1423	-
			UKI 100 65 55 41	▲	996	1015	1101	1186	1199	1254	1356	1492	-
			UKI 120 65 55 41	▲	1045	1071	1160	1248	1259	1317	1428	1571	-
			Note: Please follow the fitting instructions from the appliance manufacturers. Cutlery organisers are not available for this article.										
256 386 	<b>Hob base unit for hob extractor</b> 1 fixed inside panel 1 drawer 25.6 cm with wooden rear panel 1 pull-out 38.6 cm with wooden rear panel		UDK 70 65 55 028	▲	812	820	902	982	996	1044	1138	1252	-
			UDK 80 65 55 028	▲	812	820	902	982	996	1044	1138	1252	-
			UDK 90 65 55 028	▲	812	820	902	982	996	1044	1138	1252	-
			UDK 100 65 55 028	▲	827	847	926	1006	1014	1076	1161	1277	-
			UDK 120 65 55 028	▲	849	862	949	1035	1040	1091	1194	1313	-
						Note: The pull-outs are adapted to the respective hob extractor type. We will not assume any liability for damage caused by moisture.							

## Sink carcasses 65 cm high

Carcase depth 55.5 cm (standard)

□ = Models also available in 45.5/61 cm carcase depth (order no.: replace ... 55 ... with 45/61) ▲ = Types also available with 61 cm carcase depth (order no. ... replace ... 55 ... with 61)

646 	<b>Sink carcass</b> 1 door 64.6 cm 1 inside panel 1 aluminium protective shelf		US 40 65 55 701	R/L ▲	199	214	229	287	322	340	374	411	-
			US 45 65 55 701	R/L ▲	199	214	229	287	322	340	374	411	-
			US 50 65 55 701	R/L ▲	204	215	230	288	323	349	378	416	-
			US 60 65 55 701	R/L ▲	231	246	267	331	368	389	430	473	-
646 	<b>Sink carcass</b> 2 doors 64.6 cm Left door with buffer strip Without centre panel 1 inside panel 1 aluminium protective shelf		US 80 65 55 701	▲	267	280	308	440	507	547	610	671	-
			US 90 65 55 701	▲	269	285	311	442	509	550	616	678	-
			US 100 65 55 701	▲	287	299	329	472	515	553	620	682	-
			US 120 65 55 701	▲	326	346	389	542	588	637	716	788	-
646 	<b>Sink carcass</b> 1 door 64.6 cm 1 inside panel		US 30 65 55 702	R/L □	176	188	207	261	299	319	354	389	-
			US 40 65 55 702	R/L □	176	188	207	261	299	319	354	389	-
			US 45 65 55 702	R/L □	176	188	207	261	299	319	354	389	-
			US 50 65 55 702	R/L □	176	188	207	261	299	322	359	395	-
			US 60 65 55 702	R/L □	207	218	239	304	340	364	403	443	-
646 	<b>Sink carcass</b> 2 doors 64.6 cm Left door with buffer strip 1 inside panel Without centre panel		US 80 65 55 702	□	230	245	270	407	474	509	573	630	-
			US 90 65 55 702	□	230	245	270	407	474	509	577	635	-
			US 100 65 55 702	□	244	257	288	427	474	509	578	636	-
			US 120 65 55 702	□	280	302	342	496	547	595	669	736	-

# Sink carcasses 65 cm high

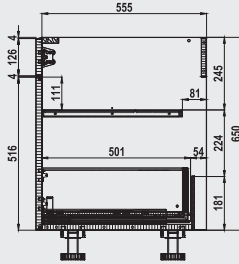
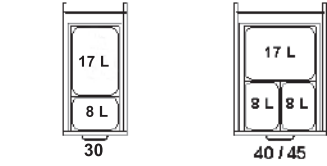
Carcase depth 55.5 cm (standard)

□ = Models also available in 45.5/61 cm carcass depth (order no.: replace ... 55 ... with 45/61)  
 ▲ = Types also available with 61 cm carcass depth (order no. ... replace ... 55 ... with 61)

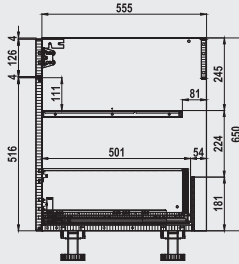
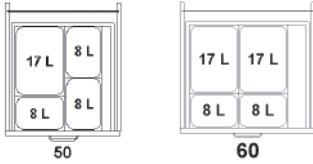
Order no.  
 W H D

Hinge side:	Carcass depth	Price groups									
		1	2	3	4	5	6	7	8	9	
▲	55.5	US 30 65 55 88	585	593	621	689	703	728	761	837	-
		US 40 65 55 88	585	593	621	689	703	728	761	837	-
		US 45 65 55 88	585	593	621	689	703	728	761	837	-
▲	55.5	US 50 65 55 88	620	624	652	717	736	758	792	871	-
		US 60 65 55 88	648	658	700	758	776	796	831	914	-
▲	55.5	US 30 65 55 81	299	307	325	378	416	436	472	519	-
		US 40 65 55 81	299	307	325	378	416	436	472	519	-
		US 45 65 55 81	299	307	325	378	416	436	472	519	-
		US 50 65 55 81	299	307	325	378	416	439	476	524	-
		US 60 65 55 81	326	339	363	423	456	480	522	574	-
▲	55.5	US 30 65 55 881	585	593	621	689	703	728	761	837	-
		US 40 65 55 881	585	593	621	689	703	728	761	837	-
		US 45 65 55 881	585	593	621	689	703	728	761	837	-

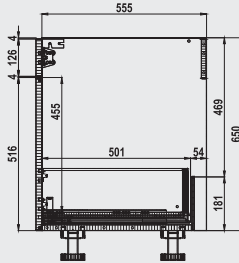
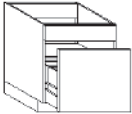
126 516  
**Sink carcass**  
 1 panel 12.6 cm  
 1 front pull-out 51.6 cm  
 with waste bins



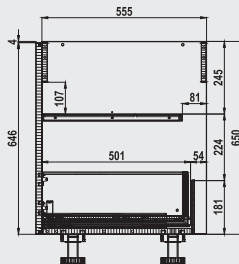
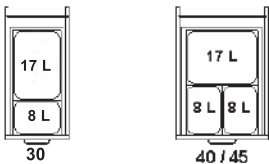
126 516  
**Sink carcass**  
 1 panel 12.6 cm  
 1 front pull-out 51.6 cm  
 with 4 waste bins



126 516  
**Sink carcass**  
 1 panel 12.6 cm  
 1 front pull-out 51.6 cm



646  
**Sink carcass**  
 1 inside panel  
 1 front pull-out 64.6 cm  
 with waste bins



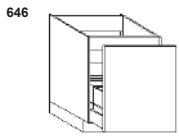
# Sink carcasses 65 cm high

Carcase depth 55.5 cm (standard)

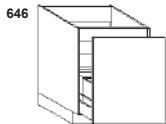
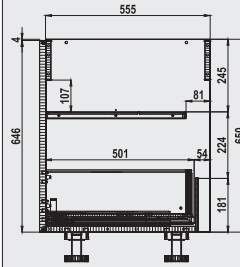
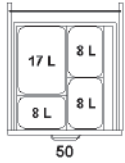
□ = Models also available in 45.5/61 cm carcass depth (order no.: replace ... 55 ... with 45/61)  
 ▲ = Types also available with 61 cm carcass depth (order no.: ... replace ... 55 ... with 61)

Order no.  
W H D

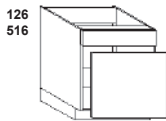
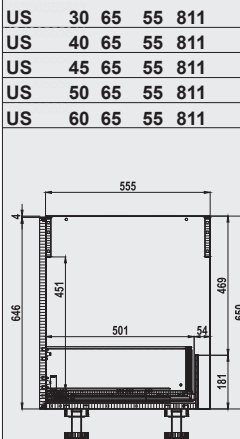
Hinge side: Carcass depth	Price groups								
	1	2	3	4	5	6	7	8	9
▲	620	624	652	717	736	758	792	871	-
	648	658	700	758	776	796	831	914	-
▲	299	307	325	378	416	436	472	519	-
	299	307	325	378	416	436	472	519	-
	299	307	325	378	416	436	472	519	-
	299	307	325	378	416	439	476	524	-
	326	339	363	423	456	480	522	574	-
▲	199	214	229	287	322	340	374	411	-
	204	215	230	288	323	349	378	416	-
	231	246	267	331	368	389	430	473	-
▲	199	214	229	287	322	340	374	411	-
	204	215	230	288	323	349	378	416	-
	231	246	267	331	368	389	430	473	-
	34								



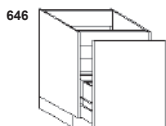
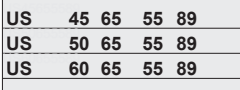
**Sink carcass**  
 1 inside panel  
 1 front pull-out 64.6 cm  
 with 4 waste bins



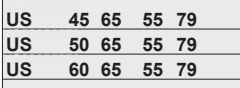
**Sink carcass**  
 1 inside panel  
 1 front pull-out 64.6 cm



**Sink carcass for waste bin**  
 1 panel 12.6 cm  
 1 front 51.6 cm, separate  
 1 aluminium protective shelf



**Sink carcass for waste bin**  
 1 inside panel  
 1 front 64.6 cm, separate  
 1 aluminium protective shelf

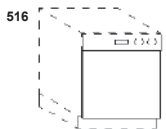


**Extra charge Sink carcass with full back panel**

SA50SVR

## Fronts for electrical appliances 65 cm high

Please specify the dishwasher item number when ordering.



**Base unit door, 51.6 cm high**  
 as front panel for **integrated**  
 dishwashers 82 cm high  
 44.6 cm wide with 45 cm  
 59.6 cm wide with 60 cm

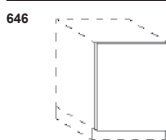
**Important!**  
 Minimum plinth height 17 cm

UT 45 52

70 74 89 112 149 163 181 199 -

UT 60 52

82 85 99 134 178 188 216 238 -



**Base unit door, 64.6 cm high**  
 as front panel for **fully integrated**  
 dishwashers 82 cm high  
 and pull-out fridges  
 and freezers  
 44.6 cm wide with 45 cm  
 59.6 cm wide with 60 cm

UT 45 65 1

96 100 108 120 186 207 244 268 -

UT 60 65 1

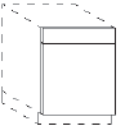
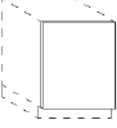
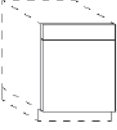
108 112 122 134 218 236 281 309 -



# Fronts for electrical appliances 65 cm high

Please specify the dishwasher item number when ordering.

Order no.  
W H D

Hinge side:	Carcass depth	Price groups								
		1	2	3	4	5	6	7	8	9
<p><b>126 516</b></p>  <p><b>Base unit door, 64.6 cm high</b> drawer panel 12.6 cm attached to door 51.6 cm</p> <p>44.6 cm wide with 45 cm <i>Surcharge in connection with the grip rails N700 and N775 incl. connecting plate and additional grip rails</i></p> <p>59.6 cm wide with 60 cm <i>Surcharge in connection with the grip rails N700 and N775 incl. connecting plate and additional grip rails</i></p>										
<p><b>646</b></p>  <p><b>Base unit door, 64.6 cm high</b> for integrated built-under fridges with door and fully integrated washing machines</p> <p>44.6 cm wide with 45 cm 59.6 cm wide with 60 cm</p>										
<p><b>126 516</b></p>  <p><b>Base unit door, 64.6 cm high</b> drawer panel 12.6 cm attached to door 51.6 cm</p> <p>44.6 cm wide with 45 cm <i>Surcharge in connection with the grip rails N700 and N775 incl. connecting plate and additional grip rails</i></p> <p>59.6 cm wide with 60 cm <i>Surcharge in connection with the grip rails N700 and N775 incl. connecting plate and additional grip rails</i></p>										
<p><b>Front decor panels</b> Price group 1 - 3: lamine in front decor or smooth lacquering Price group 4 - 7: smooth veneer, smooth lacquering or laminate</p>										
<p><b>Important!</b> Minimum plinth height 17 cm</p>										
<p><b>UTV 45 65</b> Extra charge for MP-GSN...</p>										
<p><b>UTV 60 65</b> Extra charge for MP-GSN...</p>										
<p><b>UT 45 65 11</b> R/L</p>										
<p><b>UT 60 65 11</b> R/L</p>										
<p><b>UTV 45 651</b> R/L</p>										
<p><b>UTV 60 651</b> R/L</p>										
<p>per m<sup>2</sup>, W x H</p>										
<p><b>DP 00</b></p>										
<p><b>minimum price</b></p>										
<p><b>Note:</b> Price per m<sup>2</sup>, Minimum price: 0.5 m<sup>2</sup> <b>Not available for:</b> TOP 1251/2/4; TOP 1256/7/9, TOP 1296-1309, TOP 1346-1364 TOP 1396/9, TOP 1421/4, TOP 1431/4, TOP 1441-1449, TOP 1486/9 TOP 1586-1589, TREND 1581-1584, TREND 1596-1599 SHERWOOD, PUR, EDITION, CASA-B, SIGNUM-B, MIAMI, FRAME, SMART, SMART-M, VILLAGE 15-S, VILLAGE 15-B, SOFIE-S, SOFIE-B, FENIX-INOX, SMART MIRROR, OSLO 15, LUGANO, TESSIN 15, BAVARIA, MONTANA, NEVADA; PADUA, MODENA, FLORENZ</p>										



# Corner base units 65 cm high

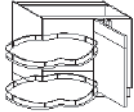
Carcase depth 55.5 cm (standard)

▲ = Types also available with 61 cm carcass depth (order no. ... replace ... 55 ... with 61)

Order no.  
W H D

Hinge side:	Carcass depth	Price groups								
		1	2	3	4	5	6	7	8	9

**126**  
**516**



**Corner base unit „Le Mans“**  
Blind section left or right  
1 panel 12.6 cm attached to door 51.6 cm  
2 wooden carousel shelves with chrome-plated rail  
fully swivelling „Le Mans“  
Carcass width 100 cm with loose corner filler

Ill. right

Door 45 cm

Door 50 cm

Door 60 cm

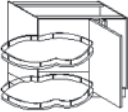
**Extra charge**  
**for extending corner filler width**

**Note:**  
Items in ALU TEC RP models  
only available with a fixed corner angle min. dimensions 6 x 6 cm!  
Please allow for shelf turning space and 50 cm clearance for carousel shelves.  
handle N700/775: with fixed corner angle

<b>UE 110 65 55 64</b>	R/L ▲	897	903	933	991	1071	1098	1147	1262	-
<b>UE 115 65 55 64</b>	R/L ▲	931	940	969	1026	1107	1132	1182	1300	-
<b>UE 125 65 55 64</b>	R/L ▲	977	987	1019	1107	1188	1218	1271	1398	-

<b>PLV</b>		24,20	25,10	25,10	34	34	34	34	37	-
------------	--	-------	-------	-------	----	----	----	----	----	---

**646**



**Corner base unit „Le Mans“**  
Blind section left or right  
1 door 64.6 cm high  
2 wooden carousel shelves with chrome-plated rail  
fully swivelling „Le Mans“  
Carcass width 100 cm with loose corner filler

Ill. right

Door 45 cm

Door 50 cm

Door 60 cm

**Extra charge**  
**for extending corner filler width**

**Note:**  
Items in ALU TEC RP models  
only available with a fixed corner angle min. dimensions 6 x 6 cm!  
Please allow for shelf turning space and 50 cm clearance for carousel shelves.  
handle N700/775: with fixed corner angle

<b>UE 110 65 55 74</b>	R/L ▲	897	903	933	991	1071	1098	1147	1262	-
<b>UE 115 65 55 74</b>	R/L ▲	931	940	969	1026	1107	1132	1182	1300	-
<b>UE 125 65 55 74</b>	R/L ▲	977	987	1019	1107	1188	1218	1271	1398	-

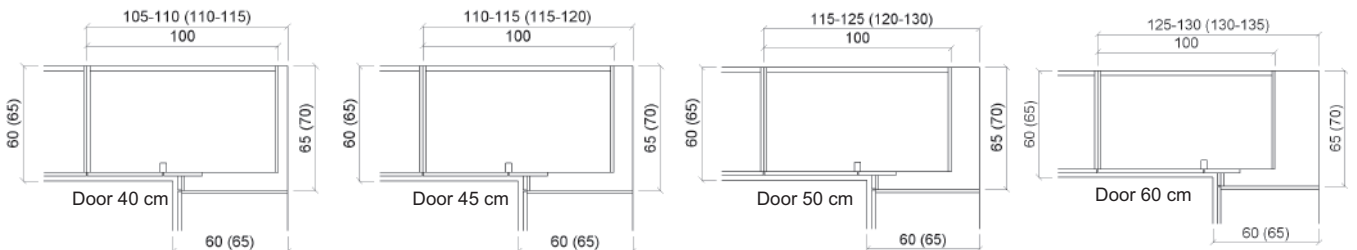
<b>PLV</b>		24,20	25,10	25,10	34	34	34	34	37	-
------------	--	-------	-------	-------	----	----	----	----	----	---



**Cushioned self-closing mechanism for „Le Mans“ carousel shelves**

<b>Z 142</b>	R/L	41								
--------------	-----	----	--	--	--	--	--	--	--	--

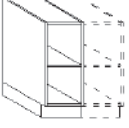

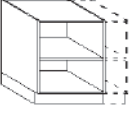

**Important!**  
Version L = left suitable for unit types in the version L=left  
Version R = right suitable for unit types in the version R=right






## Base shelf units 65 cm high

Carcase depth 57.7 cm, flush with front

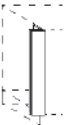




■ = = Models also available in 36.1/47.7/63.2 cm carcass depth  
(Order no.: replace ... 58 ... with 36/48/63)

		Order no.		Hinge side:	Carcass depth	Decor groups								
		W	H			D	M10	M20	M30	M40	M50	M60	M70	M80
 <p><b>Base shelf unit</b> 1 adjustable shelf</p> <p>wide in cm: 13-30</p> <p>wide in cm: 30,1-40</p> <p>wide in cm: 40,1-45</p> <p>wide in cm: 45,1-50</p> <p>wide in cm: 50,1-60</p>		<b>UR 30 65 58</b>		■	204	-	-	-	708	-	708	708	-	
		<b>UR 40 65 58</b>		■	204	-	-	-	708	-	708	708	-	
		<b>UR 45 65 58</b>		■	204	-	-	-	708	-	708	708	-	
		<b>UR 50 65 58</b>		■	204	-	-	-	708	-	708	708	-	
		<b>UR 60 65 58</b>		■	204	-	-	-	708	-	708	708	-	
 <p><b>Base shelf unit</b> 1 adjustable shelf</p> <p>wide in cm: 60,1-80</p> <p>wide in cm: 80,1-90</p>		<b>UR 80 65 58</b>		■	229	-	-	-	801	-	1036	1036	-	
		<b>UR 90 65 58</b>		■	229	-	-	-	801	-	1036	1036	-	
<b>M 10</b>	<b>M 20</b>	<b>M 30</b>	<b>M 40</b>	<b>M 50</b>										
K M10 laminate				B M50 Velvet lacquer S M50 microstructure lacquer										
<b>M 60</b>	<b>M 70</b>	<b>M 80</b>	<b>M 90</b>											
	F M70 veneer / oak / walnut Z M70 Veneer / Bavaria	H M80 high gloss-Lacquer MP M80 laqué mat Premium												

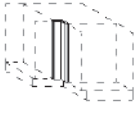



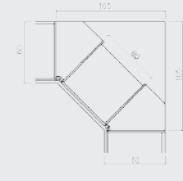

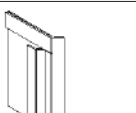
## Background filler 65 cm high

 <p><b>Base unit background filler</b> Width: 20 cm For fitting flush with carcass</p>	Unit price										
	<b>UPSL 00 65</b>		25,70	28,50	38	50	50	50	50	50	50
 <p><b>Base unit corner background fillers</b> For corner solution 105 x 105 cm</p>	Unit price										
	<b>UWSL 65 1</b>		50	50	63	84	84	84	84	84	84
 <b>Important!</b> Planning dimensions 25.9 x 25.9 cm 2 x model required for diagonal corner solution.											
<b>M 10</b>	<b>M 20</b>	<b>M 30</b>	<b>M 40</b>	<b>M 50</b>							
K M10 laminate	D M20 Laminate decor	I M30 RESOPAL PRO super matt IH M30 HPL PRO PW M30 PRIMEWOOD/Basic Veneer	A M40 DIRECTLACK matt L M40 DIRECTLACK high-gloss	B M50 Velvet lacquer P M50 Soft lacquer S M50 microstructure lacquer							
<b>M 60</b>	<b>M 70</b>	<b>M 80</b>	<b>M 90</b>								
QH M60 SMARTGLAS high-gloss QM M60 SMARTGLAS satin-finish	F M70 veneer / oak / walnut Z M70 Veneer / Bavaria	C1 M80 FENIX stainless-steel look H M80 high gloss-Lacquer MP M80 laqué mat Premium									

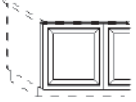
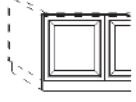
## Front filler 65 cm high

		Order no.		Hinge side:	Carcass depth	Price groups								
		W	H			D	1	2	3	4	5	6	7	8
 <p><b>Base unit front filler</b></p> <p>3.5 - 10 cm</p> <p>10.1 - 20 cm</p>		<b>UP 10 65</b>			50	50	53	71	71	71	75	83	-	
		<b>UP 20 65</b>			60	60	64	88	88	88	98	108	-	
 <p><b>Base unit front filler with buffer strip</b> and 1 door 64.6 cm, 10 - 20 cm</p>		<b>UPA 20 65</b>		R/L	87	87	93	141	141	141	159	175	-	
		<b>UPZ 20 65</b>			60	60	64	88	88	88	98	108	-	
 <b>Not available for:</b> MIAMI, VIVA														

# Corner filler 65 cm high

		Price groups										
		1	2	3	4	5	6	7	8	9		
 <p><b>Base unit corner filler 90°</b> 9.5 x 9.5 cm up to 20 x 20 cm</p>	<p><b>Order no.</b> W H D</p>	<p><b>Hinge side:</b></p> <p><b>Carcase depth:</b></p>										
		<p><b>Important!</b> Planning dimensions 65 x 65 cm Items can only be fitted in the ALU TEC RP models with a minimum size of 6 x 6 cm.</p>		<p><b>UPW 65 65</b>      88 88 103 117 117 117 128 141 -</p> <p><b>UPW 75 65</b>      98 98 110 123 123 123 159 175 -</p>								
 <p><b>Base unit corner filler 90° with grip ledge N700/775</b> 9.5 x 9.5 cm up to 20 x 20 cm</p> 		<p><b>Important!</b> Planning dimensions 65 x 65 cm</p>										
		<p><b>UPWN 65 65</b>      88 88 103 117 117 117 128 141 -</p> <p>Extra charge for N...      62 62 62 62 62 62 62 62</p> <p><b>UPWN 75 65</b>      98 98 110 123 123 123 159 175 -</p> <p>Extra charge for N...      62 62 62 62 62 62 62 62</p>										
 <p><b>Base unit corner filler 135°</b> For corner solution 105 x 105 cm</p>		<p><b>UPW 135 65</b>      88 88 103 117 117 117 128 141 -</p> <p><b>Not available for:</b> ALU TEC RP</p> <p><b>Important!</b> Planning dimensions 25.9 x 25.9 cm</p> 										
 <p><b>Base unit corner filler for variable corner solutions / diagonal solutions</b> min. planning dimension 25.9 cm max. planning dimension 38 cm</p>		<p><b>Important!</b> 2 x model required for diagonal corner solution. <b>Note:</b> Please specify the precise angle and angle leg. With angles less than 90°, please do not plan pull-outs/drawers or dishwashers in the corner.</p> <p><b>Not available for:</b> ALU TEC RP</p>										
 <p><b>Base unit corner filler 90° for height offset</b> 9.5 x 9.5 cm with connection height 52 cm</p>		<p><b>Important!</b> Planning dimensions 65 x 65 cm</p> <p><b>Not available for:</b> ALU TEC RP, MIAMI, VIVA</p>										
		<b>UPH 65 65 52</b>	R/L	120	120	131	143	143	143	159	175	-

## Back cladding 65 cm high with screw-fitted fronts

<p>646</p>  <p><b>Back cladding</b> for base units, 65 cm high only available in grid sizes carcase material with screw-fitted fronts 64.6 cm</p>		<p>per 10 cm Width</p> <p><b>UVF 65</b>      38 41 45 64 66 69 75 83 -</p> <p><b>Important!</b> Observe worktop excess depth 66 cm! The plinth panel required is supplied loose.</p>								
<p>646</p>  <p><b>Back cladding</b> for base units, 65 cm high only available in grid sizes carcase material extends down to floor level With screw-fitted fronts 64.6 cm</p>		<p>per 10 cm Width</p> <p><b>UVF 00 65</b>      38 41 45 64 66 69 75 83 -</p> <p><b>Important!</b> Observe worktop excess depth 66 cm! The plinth panel required is supplied loose.</p>								

## Support panel 65 cm high

		Order no.		Decor groups										
		W H D		Hinge side:	Carcass depth	M10	M20	M30	M40	M50	M60	M70	M80	M90
	<b>Base unit support panel</b> 60 cm deep, 85 cm high without plinth cutout Height to be adapted on site	Unit price												
		<b>USW 85 60</b>			46	145	247	329	329	329	329	329	329	-
	<b>Base unit support panel</b> 90 cm deep, 85 cm high without plinth cutout Height to be adapted on site	Unit price												
		<b>USW 85 90</b>			48	171	277	369	369	369	369	369	369	-
<b>M 10</b>	<b>M 20</b>	<b>M 30</b>		<b>M 40</b>		<b>M 50</b>								
K M10 laminate	D M20 Laminate decor	I M30 RESOPAL PRO super matt IH M30 HPL PRO PW M30 PRIMEWOOD/Basic Veneer		A M40 DIRECTLACK matt L M40 DIRECTLACK high-gloss		B M50 Velvet lacquer S M50 microstructure lacquer								
<b>M 60</b>	<b>M 70</b>	<b>M 80</b>		<b>M 90</b>										
QH M60 SMARTGLAS high-gloss QM M60 SMARTGLAS satin-finish	F M70 veneer / oak / walnut Z M70 Veneer / Bavaria	C1 M80 FENIX stainless-steel look H M80 high gloss-Lacquer MP M80 laqué mat Premium												

## Back cladding 65 cm high

	<b>Back cladding</b> With suspension fittings for base units, 65 cm high 16 mm thick	per 10 cm Width												
		<b>UVK 65</b>			9,10	15,50	32	42	42	42	42	42	42	-
		<b>Important!</b> Observe worktop excess depth 64 cm! The plinth panel required is supplied loose.												
	<b>Back cladding</b> With suspension fittings For base units 16 mm thick variable height	per m <sup>2</sup> , W x H												
		<b>UVK 00</b>			118	200	483	644	644	644	644	644	644	-
		<b>Important!</b> Observe worktop excess depth 64 cm! The plinth panel required is supplied loose.												
		<b>minimum price</b>												
				47	50	73	134	74	134	121	134	134	-	

## Visible sides / increased side depth 65 cm high

	<b>Base unit visible side</b>  55.5 cm side depth Fixed dimension, not variable 57.5 cm side depth Fixed dimension, not variable 60.5 cm side depth Fixed dimension, not variable 61 cm side depth Fixed dimension, not variable 70.5 cm side depth Fixed dimension, not variable	<b>Important! Installation instead of a normal unit side.</b> Only available in the listed side depths. For other dimensions, use USVT...												
		<b>USV 65</b>	R/L	0	0	63	63	83	83	94	123	-		
		<b>USV 65 5</b>	R/L	0	0	63	63	83	83	94	123	-		
		<b>USV 65 6</b>	R/L	0	0	63	63	83	83	94	123	-		
		<b>USV 65 6 1</b>	R/L	0	0	63	63	83	83	94	123	-		
		<b>USV 65 7</b>	R/L	0	0	63	63	83	83	94	123	-		
	<b>Base unit increased side depth</b>  from 61.1 cm up to 90 cm side depth Up to 60.9 cm side depth	<b>Important!</b> Installation instead of a normal unit side.												
		<b>USVT 65</b>	R/L	59	72	135	135	179	179	206	264	-		
		<b>USVT 65 6</b>	R/L	32	35	89	89	119	119	138	180	-		
<b>Central partition, separate</b>		<b>UM 65</b>		34										
<b>Central partition installed</b>		<b>UM 65E</b>		34										
<b>M 10</b>	<b>M 20</b>	<b>M 30</b>		<b>M 40</b>		<b>M 50</b>								
K M10 laminate	D M20 Laminate decor	I M30 RESOPAL PRO super matt IH M30 HPL PRO PW M30 PRIMEWOOD/Basic Veneer		A M40 DIRECTLACK matt L M40 DIRECTLACK high-gloss		B M50 Velvet lacquer P M50 Soft lacquer RH M50 Velvet lacquer wood texture RW M50 Velvet lacquer spackle effect S M50 microstructure lacquer								
<b>M 60</b>	<b>M 70</b>	<b>M 80</b>		<b>M 90</b>										
QH M60 SMARTGLAS high-gloss QM M60 SMARTGLAS satin-finish	F M70 veneer / oak / walnut V M70 Velvet lacquer textured Z M70 Veneer / Bavaria	C1 M80 FENIX stainless-steel look H M80 high gloss-Lacquer MP M80 laqué mat Premium O M80 Veneered												

## 3.2

Base units 71.5 cm high -  
half grid

Base units 71.5 cm high	XL 3.2.2-XL 3.2.7
Base units as pass-throughs 71.5 cm high	XL 3.2.7-XL 3.2.8
Base units with glass door 71.5 cm high neutral	XL 3.2.8
Additional equipment	XL 3.2.8
Oven housings 71.5 cm high	XL 3.2.9
Hob base units 71.5 cm high	XL 3.2.9-XL 3.2.10
Sink carcases 71.5 cm high	XL 3.2.11-XL 3.2.15
Base units 71.5 cm high for water purifying, boiling and chilling systems	XL 3.2.16
Corner base units Sink carcases 71.5 cm high	XL 3.2.16
Fronts for electrical appliances	XL 3.2.16-XL 3.2.18
Corner base units 71.5 cm high variable	XL 3.2.18-XL 3.2.20
Corner base units 71.5 cm high Le Mans	XL 3.2.20-XL 3.2.21
Corner base units 71.5 cm high as carousel corner unit	XL 3.2.21-XL 3.2.22
Diagonal corner base unit 71.5 cm high	XL 3.2.22-XL 3.2.23
Base shelf units 71.5 cm high	XL 3.2.24
Base shelf units 71.5 cm high	XL 3.2.25
Base shelf units 71.5 cm high, country house elements	XL 3.2.26
Base units 71.5 cm high	XL 3.2.27-XL 3.2.28
Hob base units 71.5 cm high	XL 3.2.28
spacefitter frame 71.5 cm high	XL 3.2.29
Background filler 71.5 cm high	XL 3.2.29
Front filler 71.5 cm high	XL 3.2.29
Corner filler 71.5 cm high	XL 3.2.30
Back cladding 71.5 cm high with screw-fitted fronts	XL 3.2.30
Support panel 71.5 cm high	XL 3.2.31
Back cladding 71.5 cm high	XL 3.2.31
Visible sides / increased side depth 71.5 cm high	XL 3.2.31

## Legend:



Available with grip ledge N...



Not available with grip ledge N...



This symbol indicates which models are available



This symbol indicates which models are not available



wall-mounted units



available depths for wall-mounted units



Planning advice



Merchandise net



Not available with „push-to-open“ fitting



Aperture height specifications



Available carcass depths 34/45.5/55.5/61.0 cm



Available carcass depths 45.5/55.5/61.0 cm



Available carcass depths 55.5/61.0 cm

Note:  
base units in 71.5 cm height are not available for these models:  
MIAMI, VIVA

Height  
71.5 cm

# The most important base unit models 71.5 cm high

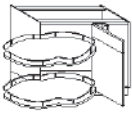
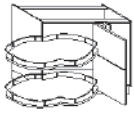
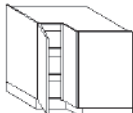
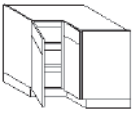
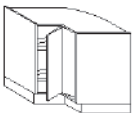
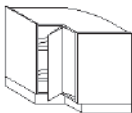
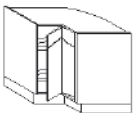
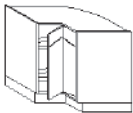
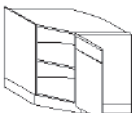
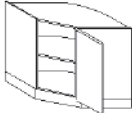
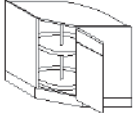
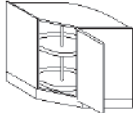
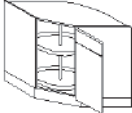
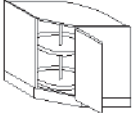
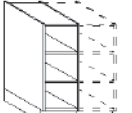
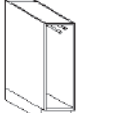
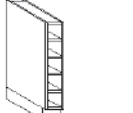
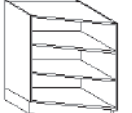
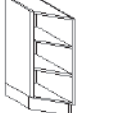
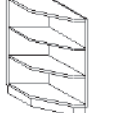
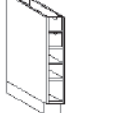

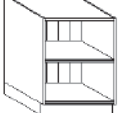
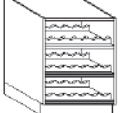


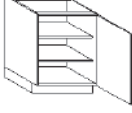
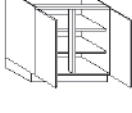
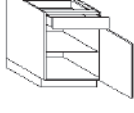
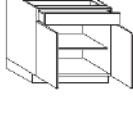
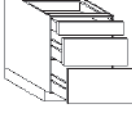
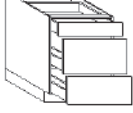
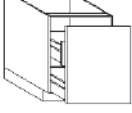
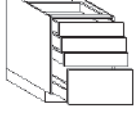
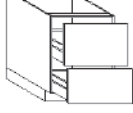
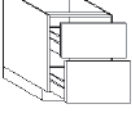
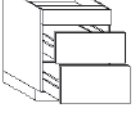
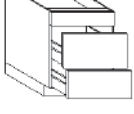
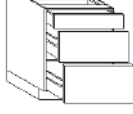
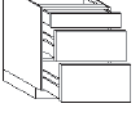
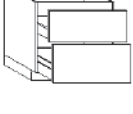
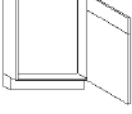

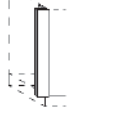
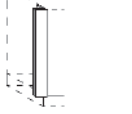



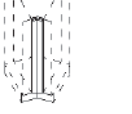

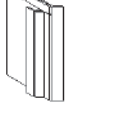
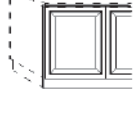
Page XL 3.2.2	Page XL 3.2.2	Page XL 3.2.2	Page XL 3.2.2	Page XL 3.2.2	Page XL 3.2.2	Page XL 3.2.2	Page XL 3.2.2	Page XL 3.2.2
U..725570 Unit widths: 20/25/30/40/ 45/50/60	U..725570 Unit widths: 80/90/100/120	U..725560 Unit widths: 30/40/45/50/60	U..725560 Unit widths: 80/90/100/120	U..725510 Unit widths: 30/40/45/50/60	U..725510 Unit widths: 70/80/90/100/120	U..725518 Unit widths: 70/80/90/100/120	U..725512 Unit widths: 30/40/45/50/60 70/80/90/100/120	U..7255120 Unit widths: 30/40/45/50/60 70/80/90/100/120
Page XL 3.2.3	Page XL 3.2.3	Page XL 3.2.3	Page XL 3.2.3	Page XL 3.2.3	Page XL 3.2.3	Page XL 3.2.3	Page XL 3.2.4	Page XL 3.2.4
U..725531 Unit widths: 30/40/45/50/60 70/80/90/100/120	U..725502 Unit widths: 30/40/45/50/60 70/80/90/100/120	U..7255020 Unit widths: 30/40/45/50/60 70/80/90/100/120	U..7255022 Unit widths: 30/40/45/50/60 70/80/90/100/120	U..72550210 Unit widths: 30/40/45/50/60 70/80/90/100/120	U..7255012 Unit widths: 30/40/45/50/60	U..725507 Unit widths: 15/20	U..725509 Unit widths: 15/20	U..726104 Unit widths: 20
Page XL 3.2.4	Page XL 3.2.4	Page XL 3.2.4	Page XL 3.2.4	Page XL 3.2.4	Page XL 3.2.4	Page XL 3.2.4	Page XL 3.2.5	Page XL 3.2.5
U..725571 Unit widths: 30	U..725561 Unit widths: 30	U..725507M Unit widths: 30	U..7255071M Unit widths: 30	UVP..725507M Unit widths: 30	UVP..725517M Unit widths: 30	U..725508 Unit widths: 30	U..7255081 Unit widths: 30	U..725515 Unit widths: 30 /50
Page XL 3.2.5	Page XL 3.2.5	Page XL 3.2.5	Page XL 3.2.5	Page XL 3.2.5	Page XL 3.2.5	Page XL 3.2.6	Page XL 3.2.6	Page XL 3.2.6
U..7255151 Unit widths: 30/50	U..725506M Unit widths: 30	U..7255061M Unit widths: 30	U..725573 Unit widths: 30/40/45/50/60	U..725563 Unit widths: 30/40/45/50/60	U..725513 Unit widths: 30/40/45/50/60	U..725514 Unit widths: 30/40/45/50/60	U..725505 Unit widths: 30/45/50/60	U..725595 Unit widths: 45
Page XL 3.2.6	Page XL 3.2.6	Page XL 3.2.7	Page XL 3.2.7	Page XL 3.2.7	Page XL 3.2.7	Page XL 3.2.7	Page XL 3.2.7	Page XL 3.2.7
U..725586 Unit widths: 60	U..725595 Unit widths: 60	U..725579 Unit widths: 30/40/45/50/60	US..725570 Unit widths: 25	US..725560 Unit widths: 25	USVTP..725507 Unit widths: 25	UDU..725570 Unit widths: 45/50/60	UDU..725570 Unit widths: 80/90/100/120	UDU..725560 Unit widths: 45/50/60
Page XL 3.2.7	Page XL 3.2.7	Page XL 3.2.8	Page XL 3.2.8	Page XL 3.2.8	Page XL 3.2.9	Page XL 3.2.9	Page XL 3.2.9	Page XL 3.2.9
UDU..725560 Unit widths: 80/90/100/120	UDU..725510 Unit widths: 45/50/60	UDU..725518 Unit widths: 80/90/100/120	E-TUO..59 Unit widths: 40/45/50/60	UGD..7255 Unit widths: 45/50/60	UH..725585 Unit widths: 60	UH..725512 Unit widths: 60	UM..725583 Unit widths: 60/90	UK..725582 Unit widths: 60/70/80/ 90/100/120



# The most important base unit models 71.5 cm high

Page XL 3.2.9	Page XL 3.2.9	Page XL 3.2.9	Page XL 3.2.10	Page XL 3.2.10	Page XL 3.2.10	Page XL 3.2.10	Page XL 3.2.10	Page XL 3.2.10
UK..7255820 Unit widths: 60/70/80/ 90/100/120	UKI..725512 Unit widths: 60/70/80/ 90/100/120	UKI..725513 Unit widths: 60/70/80/ 90/100/120	UKI..7255120 Unit widths: 60/70/80/ 90/100/120	UKI..7255121 Unit widths: 60/70/80/ 90/100/120	UKI..72554 Unit widths: 60/80/90/100/120	UKI..725541 Unit widths: 60/80/90/100/120	UKI..725540 Unit widths: 60/80/90/100/120	UKI..725542 Unit widths: 60/80/90/100/120
Page XL 3.2.10	Page XL 3.2.10	Page XL 3.2.11	Page XL 3.2.11	Page XL 3.2.11	Page XL 3.2.11	Page XL 3.2.11	Page XL 3.2.11	Page XL 3.2.11
UDK..7255020 Unit widths: 80/90/100/120	UDK..7255028 Unit widths: 70/80/90/100/120	US..7255701 Unit widths: 40/45/50/60	US..7255701 Unit widths: 80/90/100/120	US..7255702 Unit widths: 30/40/45/50/60	US..7255702 Unit widths: 80/90/100/120	US..7255601 Unit widths: 40/45/50/60	US..7255601 Unit widths: 80/90/100/120	US..7255602 Unit widths: 30/40/45/50/60
Page XL 3.2.11	Page XL 3.2.11	Page XL 3.2.12	Page XL 3.2.12	Page XL 3.2.12	Page XL 3.2.12	Page XL 3.2.13	Page XL 3.2.13	Page XL 3.2.13
US..7255602 Unit widths: 80/90/100/120	US..7255026 Unit widths: 70/80/90/100/120	US..7255028 Unit widths: 70/80/90/100/120	US..7255027 Unit widths: 80/90/100/120	US..726195 Unit widths: 45/50/60	US..7255826 Unit widths: 70/80/90/100/120	US..7255828 Unit widths: 70/80/90/100/120	US..725588 Unit widths: 30/40/45/50/60	US..725581 Unit widths: 30/40/45/50/60
Page XL 3.2.14	Page XL 3.2.14	Page XL 3.2.14	Page XL 3.2.15	Page XL 3.2.15	Page XL 3.2.15	Page XL 3.2.15	Page XL 3.2.15	Page XL 3.2.15
US..7255881 Unit widths: 30/40/45/50/60	US..7255811 Unit widths: 30/40/45/50/60	US..726193 Unit widths: 60	US..7261931 Unit widths: 60	US..725589 Unit widths: 45/50/60	US..725579 Unit widths: 45/50/60	US..7255020 Unit widths: 60	US..7255022 Unit widths: 60	US..7255021 Unit widths: 60
Page XL 3.2.16	Page XL 3.2.16	Page XL 3.2.16	Page XL 3.2.16	Page XL 3.2.16	Page XL 3.2.16	Page XL 3.2.16	Page XL 3.2.18	Page XL 3.2.18
UWS..725570 Unit widths: 45/60	USE..72557 Unit widths: 105/110/115/125	USE..72558 Unit widths: 105/110/115/125	USD..7280 Unit widths: 90x90	USD..7270 Unit widths: 90x90	USD..57280 Unit widths: 105x105	USD..57270 Unit widths: 105x105	UE..725510 Unit widths: 105/110/115/125	UE..725570 Unit widths: 105/110/115/125
Page XL 3.2.18	Page XL 3.2.19	Page XL 3.2.19	Page XL 3.2.19	Page XL 3.2.19	Page XL 3.2.19	Page XL 3.2.20	Page XL 3.2.20	Page XL 3.2.20
UE..725560 Unit widths: 105/110/115/125	UE..725512 Unit widths: 110/115/125	UE..725513 Unit widths: 110/115/125	UE..725573 Unit widths: 110/115/125	UE..725563 Unit widths: 110/115/125	UE..725571 Unit widths: 110/115/125	UE..725561 Unit widths: 110/115/125	UE..725514 Unit widths: 110/115/125	UE..725574 Unit widths: 110/115/125

# The most important base unit models 71.5 cm high



Page XL 3.2.20	Page XL 3.2.21	Page XL 3.2.21	Page XL 3.2.21	Page XL 3.2.21	Page XL 3.2.21	Page XL 3.2.21	Page XL 3.2.22	Page XL 3.2.22
								
UE..725564 Unit widths: 110/115/125	UE..7255742 Unit widths: 110/115/125	UEB..7270 Unit widths: 80x80/90x90	UEB..7260 Unit widths: 90x90	UEK..7273 Unit widths: 80x80/90x90	UEK..7272 Unit widths: 80x80/90x90	UEK..7263 Unit widths: 90x90	UEK..7262 Unit widths: 90x90	UED..7260 Unit widths: 90x90/105x105
Page XL 3.2.22	Page XL 3.2.22	Page XL 3.2.22	Page XL 3.2.22	Page XL 3.2.22	Page XL 3.2.24	Page XL 3.2.24	Page XL 3.2.24	Page XL 3.2.24
								
UED..7270 Unit widths: 90x90/105x105	UED..7263 Unit widths: 90x90/105x105	UED..7273 Unit widths: 90x90/105x105	UED..7262 Unit widths: 90x90/105x105	UED..7272 Unit widths: 90x90/105x105	UR..7258 Unit widths: 30/40/45/50/60	URH..7258 Unit widths: 15/20/25	URFL..7258 Unit widths: 15/30	URS..7258 Unit widths: 15-60
Page XL 3.2.24	Page XL 3.2.24	Page XL 3.2.24	Page XL 3.2.25	Page XL 3.2.26	Page XL 3.2.26	Page XL 3.2.26	Page XL 3.2.26	Page XL 3.2.27
								
URS..7258 Unit widths: 25	URA..7258 Unit widths: 25/34	URSK..7258 Unit widths: 15	URIF..7258IA3K Unit widths: 45/60/90	URL..7258 Unit widths: 30/45/60/90	URFL..7258 Unit widths: 30/45/60	URAL..7258 Unit widths: 57,7	URAL..7235 Unit widths: 93,8/105,4/115,4	U..727070 Unit widths: 30/40/45/50/60
Page XL 3.2.27	Page XL 3.2.27	Page XL 3.2.27	Page XL 3.2.27	Page XL 3.2.27	Page XL 3.2.27	Page XL 3.2.27	Page XL 3.2.28	Page XL 3.2.28
								
U..727070 Unit widths: 80/90/100/120	U..727010 Unit widths: 30/40/45/50/60	U..727010 Unit widths: 70/80/90/100/120	U..727012 Unit widths: 30/40/45/50/60	U..7270120 Unit widths: 30/40/45/50/60 70/80/90/100/120	U..7270012 Unit widths: 30/40/45/50/60	U..727031 Unit widths: 30/40/45/50/60 70/80/90/100/120	U..727002 Unit widths: 30/40/45/50/60 70/80/90/100/120	U..7270020 Unit widths: 30/40/45/50/60 70/80/90/100/120
Page XL 3.2.28	Page XL 3.2.28	Page XL 3.2.28	Page XL 3.2.28	Page XL 3.2.28	Page XL 3.2.29	Page XL 3.2.29	Page XL 3.2.29	Page XL 3.2.29
								
UK..727082 Unit widths: 60/70/80/ 90/100/120	UK..7270820 Unit widths: 60/70/80/ 90/100/120	UKI..727012 Unit widths: 60/70/80/ 90/100/120	UKI..7270120 Unit widths: 60/70/80/ 90/100/120	UDK..7270020 Unit widths: 80/90/100/120	UPR..721060 Unit widths: 30/40/45/50/60	UPR..721070 Unit widths: 20/25/30/40/ 45/50/60	UP..72 Unit widths: 3,5-20	UPA..72 Unit widths: 10-20
Page XL 3.2.29	Page XL 3.2.30	Page XL 3.2.30	Page XL 3.2.30	Page XL 3.2.30	Page XL 3.2.30	Page XL 3.2.30		
								
UPN..72 Unit widths: 7,5-20	UPW..72 Unit widths: 65x65/75x75	UPWN..72 Unit widths: 65x65/75x75	UPW..72 Unit widths: 105x105	UPW..72 Unit widths: 105x105	UPH..7265 Unit widths: 65x65	UVF..72 Unit widths: 65x65		

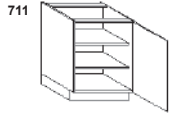
# Base units 71.5 cm high

Carcase depth 55.5 cm (standard)

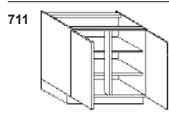
■ = Models also available in 34/45.5/61 cm carcass depth (Order no.: ... replace ... 55 ... with 34/45/61)  
 □ = Models also available in 45.5/61 cm carcass depth (order no.: replace ... 55 ... with 45/61)  
 ▲ = Types also available with 61 cm carcass depth (order no. ... replace ... 55 ... with 61)

Order no.  
 W H D

Hinge side:	Carcass depth	Price groups										
		1	2	3	4	5	6	7	8	9		
R/L	34.0 45.5 55.5 61.0	U 20 72 55 70	■	178	188	210	260	279	293	322	354	-
		U 25 72 55 70	■	178	188	210	260	279	293	322	354	-
		U 30 72 55 70	■	178	188	210	260	279	293	322	354	-
		U 40 72 55 70	■	178	188	210	264	279	299	325	358	-
		U 45 72 55 70	■	178	188	210	264	279	299	325	358	-
		U 50 72 55 70	■	178	188	210	264	299	321	357	393	-
		U 60 72 55 70	■	211	223	239	302	347	371	412	453	-
 width 20 cm: <i>FRAME, VILLAGE 15-S, VILLAGE 15-B, CHALET-S, CHALET-B, OSLO 15, TESSIN 15, BERGEN, LUGANO, CASTELLO, VIVA, TIM 15</i> are supplied with smooth fronts. width 25 cm: <i>FRAME</i> are supplied with smooth fronts.												
R/L	34.0 45.5 55.5 61.0	U 80 72 55 70	■	237	250	276	399	482	522	583	641	-
		U 90 72 55 70	■	237	250	276	399	482	522	584	642	-
		U 100 72 55 70	■	251	262	297	419	482	522	587	646	-
		U 120 72 55 70	■	288	307	351	500	569	618	697	767	-
R/L	34.0 45.5 55.5 61.0	U 30 72 55 60	■	178	188	210	260	279	293	322	354	-
		U 40 72 55 60	■	178	188	210	264	279	299	325	358	-
		U 45 72 55 60	■	178	188	210	264	279	299	325	358	-
		U 50 72 55 60	■	178	188	210	264	299	321	357	393	-
		U 60 72 55 60	■	211	223	239	302	347	371	412	453	-
R/L	34.0 45.5 55.5 61.0	U 80 72 55 60	■	237	250	276	399	482	522	583	641	-
		U 90 72 55 60	■	237	250	276	399	482	522	584	642	-
		U 100 72 55 60	■	251	262	297	419	482	522	587	646	-
		U 120 72 55 60	■	288	307	351	500	569	618	697	767	-
R/L	34.0 45.5 55.5 61.0	U 30 72 55 10	■	227	233	259	320	335	356	385	424	-
		U 40 72 55 10	■	227	233	259	321	335	359	389	428	-
		U 45 72 55 10	■	227	233	259	321	349	368	400	440	-
		U 50 72 55 10	■	227	233	259	321	349	370	406	447	-
		U 60 72 55 10	■	255	264	298	361	391	416	456	502	-
R/L	34.0 45.5 55.5 61.0	U 80 72 55 10	■	312	325	353	488	546	581	650	715	-
		U 90 72 55 10	■	312	325	353	488	546	581	650	715	-
		U 100 72 55 10	■	321	334	367	501	558	598	664	730	-
		U 120 72 55 10	■	329	345	376	517	570	612	682	750	-
 Width 80 Not available for: <i>GENT, OSLO 15, TESSIN 15, TIM 15, VILLAGE 15-B, VILLAGE 15-S</i> Width 90, 120 Not available for: <i>INTARSIA</i> Width 100												
R/L	34.0 45.5 55.5 61.0	U 80 72 55 18	■	343	359	378	518	577	615	678	746	-
		U 90 72 55 18	■	343	359	383	522	577	615	681	749	-
		U 100 72 55 18	■	360	371	398	540	577	615	682	750	-
		U 120 72 55 18	■	399	422	460	623	674	718	797	877	-
R/L	34.0 45.5 55.5 61.0	U 30 72 55 12	■	461	467	518	566	566	588	639	703	-
		U 40 72 55 12	■	461	467	518	566	566	588	639	703	-
		U 45 72 55 12	■	461	467	518	566	566	588	639	703	-
		U 50 72 55 12	■	461	467	518	566	566	588	639	703	-
		U 60 72 55 12	■	492	499	548	616	616	644	700	770	-
		U 70 72 55 12	■	769	782	865	948	962	1014	1110	1221	-
		U 80 72 55 12	■	769	782	865	948	962	1014	1110	1221	-
		U 90 72 55 12	■	769	782	865	948	962	1014	1110	1221	-
		U 100 72 55 12	■	793	812	900	987	1001	1057	1156	1272	-
		U 120 72 55 12	■	820	844	934	1025	1038	1098	1203	1323	-
R/L	34.0 45.5 55.5 61.0	U 30 72 55 120	■	461	467	518	566	566	588	639	703	-
		U 40 72 55 120	■	461	467	518	566	566	588	639	703	-
		U 45 72 55 120	■	461	467	518	566	566	588	639	703	-
		U 50 72 55 120	■	461	467	518	566	566	588	639	703	-
		U 60 72 55 120	■	492	499	548	616	616	644	700	770	-
		U 70 72 55 120	■	769	782	865	948	962	1014	1110	1221	-
		U 80 72 55 120	■	769	782	865	948	962	1014	1110	1221	-
		U 90 72 55 120	■	769	782	865	948	962	1014	1110	1221	-
		U 100 72 55 120	■	793	812	900	987	1001	1057	1156	1272	-
		U 120 72 55 120	■	820	844	934	1025	1038	1098	1203	1323	-



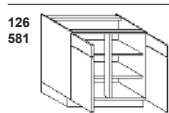
**Base unit**  
 1 door 71.1 cm  
 2 adjustable shelves



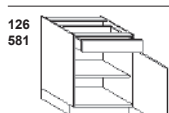
**Base unit**  
 2 doors 71.1 cm  
 2 adjustable shelves



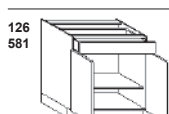
**Base unit**  
 1 panel 12.6 cm attached to  
 1 door 58.1 cm connected  
 2 adjustable shelves



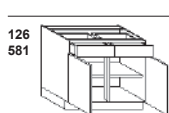
**Base unit**  
 2 panels 12.6 cm with  
 2 doors 58.1 cm  
 2 adjustable shelves



**Base unit**  
 1 drawer 12.6 cm  
 1 door 58.1 cm  
 1 adjustable shelf



**Base unit**  
 1 drawer 12.6 cm with  
 full-width panel  
 2 doors 58.1 cm  
 1 adjustable shelf  
 Left door with buffer strip  
 Without centre panel



**Base unit**  
 2 drawers 12.6 cm  
 2 doors 58.1 cm  
 1 adjustable shelf



**Base unit**  
 1 drawer 12.6 cm  
 1 pull-out 25.6 cm  
 1 pull-out 32.1 cm



**Base unit**  
 1 drawer 12.6 cm  
 1 pull-out 32.1 cm  
 1 pull-out 25.6 cm

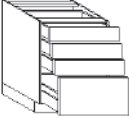
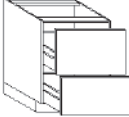
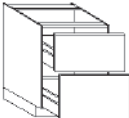
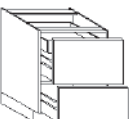
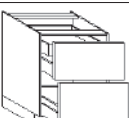
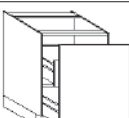
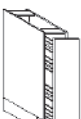



# Base units 71.5 cm high

Carcase depth 55.5 cm (standard)

- = Models also available in 34/45.5/61 cm carcass depth (Order no.: ... replace ... 55 ... with 34/45/61)
- = Models also available in 45.5/61 cm carcass depth (order no.: replace ... 55 ... with 45/61)
- ▲ = Types also available with 61 cm carcass depth (order no.: ... replace ... 55 ... with 61)

Order no.  
W H D

Hinge side: Carcass depth	Price groups													
	1	2	3	4	5	6	7	8	9					
126 126 321		<b>Base unit</b> 3 drawers 12.6 cm 1 pull-out 32.1 cm	34,0 45,5 55,5 61,0	U 30 72 55 31	■	461	476	491	562	579	602	639	703	-
				U 40 72 55 31	■	461	476	491	562	579	602	639	703	-
				U 45 72 55 31	■	461	476	491	562	579	602	639	703	-
				U 50 72 55 31	■	461	476	491	562	579	602	639	703	-
				U 60 72 55 31	■	480	488	505	587	607	637	677	745	-
				U 70 72 55 31	■	797	814	897	979	992	1044	1142	1256	-
				U 80 72 55 31	■	797	814	897	979	992	1044	1142	1256	-
				U 90 72 55 31	■	797	814	897	979	992	1044	1142	1256	-
				U 100 72 55 31	■	832	854	943	1029	1044	1100	1203	1323	-
U 120 72 55 31	■	865	895	990	1080	1094	1154	1264	1390	-				
386 321		<b>Base unit</b> 1 pull-out 38.6 cm 1 pull-out 32.1 cm	34,0 45,5 55,5 61,0	U 30 72 55 02	■	426	436	485	536	536	559	608	669	-
				U 40 72 55 02	■	426	436	485	536	536	559	608	669	-
				U 45 72 55 02	■	426	436	485	536	536	559	608	669	-
				U 50 72 55 02	■	426	436	485	536	536	559	608	669	-
				U 60 72 55 02	■	461	471	517	582	582	615	666	733	-
				U 70 72 55 02	■	736	749	834	917	932	983	1080	1188	-
				U 80 72 55 02	■	736	749	834	917	932	983	1080	1188	-
				U 90 72 55 02	■	736	749	834	917	932	983	1080	1188	-
				U 100 72 55 02	■	756	772	856	943	956	1012	1109	1220	-
U 120 72 55 02	■	773	790	881	971	981	1038	1141	1255	-				
321 386		<b>Base unit</b> 1 pull-out 32.1 cm 1 pull-out 38.6 cm	34,0 45,5 55,5 61,0	U 30 72 55 020	■	426	436	485	536	536	559	608	669	-
				U 40 72 55 020	■	426	436	485	536	536	559	608	669	-
				U 45 72 55 020	■	426	436	485	536	536	559	608	669	-
				U 50 72 55 020	■	426	436	485	536	536	559	608	669	-
				U 60 72 55 020	■	461	471	517	582	582	615	666	733	-
				U 70 72 55 020	■	736	749	834	917	932	983	1080	1188	-
				U 80 72 55 020	■	736	749	834	917	932	983	1080	1188	-
				U 90 72 55 020	■	736	749	834	917	932	983	1080	1188	-
				U 100 72 55 020	■	756	772	856	943	956	1012	1109	1220	-
U 120 72 55 020	■	773	790	881	971	981	1038	1141	1255	-				
386 321		<b>Base unit</b> 1 pull-out 38.6 cm 1 internal drawer 1 pull-out 32.1 cm	34,0 45,5 55,5 61,0	U 30 72 55 022	■	538	547	594	646	646	666	719	791	-
				U 40 72 55 022	■	546	553	599	652	652	675	726	799	-
				U 45 72 55 022	■	547	554	602	653	653	676	727	800	-
				U 50 72 55 022	■	548	555	603	654	654	677	728	801	-
				U 60 72 55 022	■	594	604	649	718	718	746	802	882	-
				U 70 72 55 022	■	876	890	976	1062	1074	1126	1224	1346	-
				U 80 72 55 022	■	876	890	976	1062	1074	1126	1224	1346	-
				U 90 72 55 022	■	881	895	979	1065	1078	1130	1227	1350	-
				U 100 72 55 022	■	905	922	1012	1096	1111	1166	1267	1394	-
U 120 72 55 022	■	956	974	1068	1153	1171	1227	1333	1466	-				
321 386		<b>Base unit</b> 1 drawer with panel 32.1 cm 1 internal drawer 1 pull-out 38.6 cm	34,0 45,5 55,5 61,0	U 30 72 55 0210	■	538	547	594	646	646	666	719	791	-
				U 40 72 55 0210	■	546	553	599	652	652	675	726	799	-
				U 45 72 55 0210	■	547	554	602	653	653	676	727	800	-
				U 50 72 55 0210	■	548	555	603	654	654	677	728	801	-
				U 60 72 55 0210	■	594	604	649	718	718	746	802	882	-
				U 70 72 55 0210	■	876	890	976	1062	1074	1126	1224	1346	-
				U 80 72 55 0210	■	876	890	976	1062	1074	1126	1224	1346	-
				U 90 72 55 0210	■	881	895	979	1065	1078	1130	1227	1350	-
				U 100 72 55 0210	■	905	922	1012	1096	1111	1166	1267	1394	-
U 120 72 55 0210	■	956	974	1068	1153	1171	1227	1333	1466	-				
711		<b>Base unit</b> 1 pull-out with front panel 71.1 cm 1 internal pull-out	34,0 45,5 55,5 61,0	U 30 72 55 012	□	465	477	523	573	573	598	650	715	-
				U 40 72 55 012	□	465	477	523	573	573	598	650	715	-
				U 45 72 55 012	□	465	477	523	573	573	598	650	715	-
				U 50 72 55 012	□	465	477	523	573	573	598	650	715	-
				U 60 72 55 012	□	498	509	555	624	624	655	711	782	-
711		<b>Base unit</b> 1 pull-out 71.1 cm 2 fixed-position baskets with metal base and chrome-plated, square-section rail	PTO	U 15 72 55 07	▲	297	302	328	391	413	430	462	508	-
				 <b>Important!</b> Most handles arranged vertically! Available frame fronts are supplied with smooth fronts.										
<b>Set of 3 separating bars</b>				TRB15-3		15								

All units not available in: MIAMI, VIVA  
□ = Merchandise net








■ = extra charge for wall-mounted units, item: MP-WST

# Base units 71.5 cm high

Carcase depth 55.5 cm (standard)

■ = Models also available in 34/45.5/61 cm carcass depth (Order no.: ... replace ... 55 ... with 34/45/61)  
 □ = Models also available in 45.5/61 cm carcass depth (order no.: replace ... 55 ... with 45/61)  
 ▲ = Types also available with 61 cm carcass depth (order no. ... replace ... 55 ... with 61)

Order no.  
 W H D

Hinge side:	Carcass depth	Price groups														
		1	2	3	4	5	6	7	8	9						
▲		U	15	72	55	09	▲	310	319	342	407	430	442	477	525	-
 <b>Important!</b> Most handles arranged vertically! Available frame fronts are supplied with smooth fronts.																
▲		U	20	72	55	07	▲	297	302	328	391	413	430	462	508	-
 <b>Not available for:</b> BERGEN, LUGANO  <b>Note:</b> Pull-out as for unit in 15 cm width (U 15 72 55 07) width 20 cm: FRAME, VILLAGE 15-S, VILLAGE 15-B, CHALET-S, CHALET-B, OSLO 15, TESSIN 15, BERGEN, LUGANO, CASTELLO, VIVA, TIM 15 are supplied with smooth fronts.																
▲		U	20	72	55	09	▲	310	319	342	407	430	442	477	525	-
 <b>Not available for:</b> BERGEN, LUGANO  <b>Note:</b> Pull-out as for unit in 15 cm width (U 15 72 55 09) width 20 cm: FRAME, VILLAGE 15-S, VILLAGE 15-B, CHALET-S, CHALET-B, OSLO 15, TESSIN 15, BERGEN, LUGANO, CASTELLO, VIVA, TIM 15 are supplied with smooth fronts.																
		U	20	72	55	04		363	368	393	457	479	496	528	581	-
 <b>Not available with TIP-ON Blumotion</b> width 20 cm: FRAME, VILLAGE 15-S, VILLAGE 15-B, CHALET-S, CHALET-B, OSLO 15, TESSIN 15, BERGEN, LUGANO, CASTELLO, VIVA, TIM 15 are supplied with smooth fronts.																
R/L	▲	U	30	72	55	71		199	211	231	293	300	317	351	386	-
R/L	▲	U	30	72	55	61		199	211	231	293	300	317	351	386	-
▲		U	30	72	55	07M	▲	493	504	526	571	589	604	637	701	-
▲		U	30	72	55	071M	▲	493	504	526	571	589	604	637	701	-
▲		UVP	30	72	55	07M	▲	619	629	651	693	711	726	758	834	-
▲		UVP	30	72	55	17M	▲	619	629	651	693	711	726	758	834	-
▲		U	30	72	55	08	▲	624	637	656	700	718	732	763	839	-
 <b>Note:</b> May not be planned directly against a wall.																





# Base units 71.5 cm high

Carcase depth 55.5 cm (standard)

■ = Models also available in 34/45.5/61 cm carcass depth (Order no.: ... replace ... 55 ... with 34/45/61)  
 □ = Models also available in 45.5/61 cm carcass depth (order no.: replace ... 55 ... with 45/61)  
 ▲ = Types also available with 61 cm carcass depth (order no.: ... replace ... 55 ... with 61)

Order no.  
W H D

Hinge side:	Carcass depth	Price groups									
		1	2	3	4	5	6	7	8	9	
▲	55.5	U 30 72 55 081	624	637	656	700	718	732	763	839	-
		<b>Note:</b> May not be planned directly against a wall.									
R/L	▲	U 40 72 55 09	442	451	476	533	546	564	594	653	-
▲	55.5	U 30 72 55 15	321	328	357	418	441	460	488	537	-
		U 50 72 55 15	357	366	390	464	479	505	540	594	-
▲	55.5	U 30 72 55 151	425	434	463	524	547	563	594	653	-
		U 50 72 55 151	472	480	502	578	593	620	653	718	-
▲	55.5	U 30 72 55 06M	564	576	597	641	658	674	704	774	-
▲	55.5	U 30 72 55 061M	564	576	597	641	658	674	704	774	-
		<b>Planning advice:</b> Doors with wide angle hinges may not be planned alongside units or panels if the protrusion to the front of the adjoining article is greater than 3 cm (hinge side). Doors with wide angle hinges protrude over the carcass side.									
R/L	■	U 30 72 55 73	440	446	467	541	555	580	617	679	-
R/L	■	U 40 72 55 73	440	446	467	541	555	580	617	679	-
R/L	■	U 45 72 55 73	440	446	467	541	555	580	617	679	-
R/L	■	U 50 72 55 73	440	446	467	541	555	580	617	679	-
R/L	■	U 60 72 55 73	465	481	501	580	599	625	663	729	-
<b>Planning advice:</b> Doors with wide angle hinges may not be planned alongside units or panels if the protrusion to the front of the adjoining article is greater than 3 cm (hinge side). Doors with wide angle hinges protrude over the carcass side.											
R/L	■	U 30 72 55 63	440	446	467	541	555	580	617	679	-
R/L	■	U 40 72 55 63	440	446	467	541	555	580	617	679	-
R/L	■	U 45 72 55 63	440	446	467	541	555	580	617	679	-
R/L	■	U 50 72 55 63	440	446	467	541	555	580	617	679	-
R/L	■	U 60 72 55 63	465	481	501	580	599	625	663	729	-
<b>Planning advice:</b> Doors with wide angle hinges may not be planned alongside units or panels if the protrusion to the front of the adjoining article is greater than 3 cm (hinge side). Doors with wide angle hinges protrude over the carcass side.											
R/L	■	U 30 72 55 13	453	462	484	555	569	597	629	692	-
R/L	■	U 40 72 55 13	453	462	484	555	569	597	629	692	-
R/L	■	U 45 72 55 13	453	462	484	555	569	597	629	692	-
R/L	■	U 50 72 55 13	453	462	484	555	569	597	629	692	-
R/L	■	U 60 72 55 13	483	493	522	597	615	641	678	746	-
<b>Planning advice:</b> Doors with wide angle hinges may not be planned alongside units or panels if the protrusion to the front of the adjoining article is greater than 3 cm (hinge side). Doors with wide angle hinges protrude over the carcass side.											

# Base units 71.5 cm high

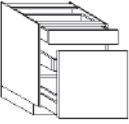
Carcase depth 55.5 cm (standard)

- = Models also available in 34/45.5/61 cm carcass depth (Order no.: ... replace ... 55 ... with 34/45/61)
- = Models also available in 45.5/61 cm carcass depth (order no.: replace ... 55 ... with 45/61)
- ▲ = Types also available with 61 cm carcass depth (order no. ... replace ... 55 ... with 61)

Order no.  
W H D

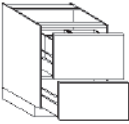
Hinge side:	Carcass depth	Price groups								
		1	2	3	4	5	6	7	8	9
U	34, 45, 55, 61, 0	418	423	451	523	541	561	598	658	-
		418	423	451	523	541	561	598	658	-
		418	423	451	523	541	561	598	658	-
		418	423	451	523	541	561	598	658	-
		447	462	491	559	573	603	643	707	-
U		676	684	735	781	781	805	855	941	-
		676	684	735	781	781	805	855	941	-
U		676	684	735	781	781	805	855	941	-
		709	718	765	829	829	860	917	1009	-
U		520	534	555	621	658	677	718	790	-
		Not available with TIP-ON								
U		641	657	700	716	745	757	785	864	-
		Not available with TIP-ON								
U		547	561	582	648	685	704	745	820	-
		Not available with TIP-ON								

126  
581

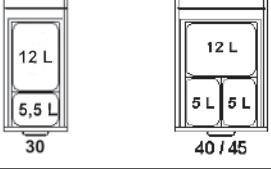


**Base unit**  
1 drawer 12.6 cm  
1 pull-out with front panel 58.1 cm  
with 1 internal drawer

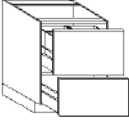
386  
321



**Base unit**  
1 pull-out 38.6 cm  
with waste bins  
1 pull-out 32.1 cm



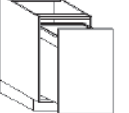
386  
321



**Base unit**  
1 pull-out 38.6 cm  
with 4 waste bins  
1 pull-out 32.1 cm



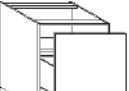
711



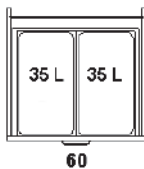
**Base unit**  
1 pull-out with front panel 71.1 cm  
with frame and 1 waste bin  
for dropping in (Hailo)  
waste system: 1x55 litres




711



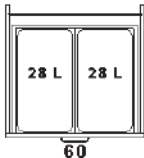
**Base unit**  
1 pull-out with front panel 71.1 cm  
2 waste bins in the pull-out  
waste system: 2x35 litres



711



**Base unit**  
1 pull-out with front panel 71.1 cm  
with frame and 2 waste bins  
for dropping in (Hailo)  
1 internal drawer





# Base units 71.5 cm high

Carcase depth 55.5 cm (standard)

■ = Models also available in 34/45.5/61 cm carcass depth (Order no.: ... replace ... 55 ... with 34/45/61)  
 □ = Models also available in 45.5/61 cm carcass depth (order no.: replace ... 55 ... with 45/61)  
 ▲ = Types also available with 61 cm carcass depth (order no.: ... replace ... 55 ... with 61)

Order no.  
W H D

Hinge side:	Carcass depth	Price groups									
		1	2	3	4	5	6	7	8	9	
▲	60	U 60 72 55 951	547	561	582	648	685	704	745	820	-
		⚠ Not available with TIP-ON									
■	34.0 45.5 55.5 61.0	U 30 72 55 79	218	229	251	301	320	333	364	400	-
		U 40 72 55 79	218	229	251	305	320	340	367	404	-
		U 45 72 55 79	218	229	251	305	320	340	367	404	-
		U 50 72 55 79	218	229	251	305	340	363	399	439	-
		U 60 72 55 79	252	263	280	343	388	412	454	499	-
R/L	60	US 25 72 55 70	338	346	369	418	435	446	478	526	-
		⚠ Important! Worktop length 27.5 cm									
R/L	60	US 25 72 55 60	338	346	369	418	435	446	478	526	-
		⚠ Important! Worktop length 27.5 cm									
R/L	60	USVTP25 72 55 07	713	721	745	785	801	814	842	926	-
		⚠ Important! Worktop length 27.5 cm									

## Base units as pass-throughs 71.5 cm high

Carcass depth 55.5 cm (standard)

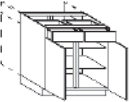



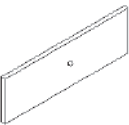
▲ = Types also available with 61 cm carcass depth (order no.: ... replace ... 55 ... with 61)

711		<b>Base unit as pass-through</b> 1 door 71.1 cm 2 adjustable shelves	UDU 45 72 55 70	R/L	▲	204	215	241	304	320	345	373	410	-
			UDU 50 72 55 70	R/L	▲	204	215	241	304	345	369	412	453	-
			UDU 60 72 55 70	R/L	▲	244	255	276	348	399	426	474	521	-
			⚠ Note: Door hinged front left = door hinged rear right. Always from the perspective of standing in front of the unit. Please order additional doors for the rear side.											
711		<b>Base unit as pass-through</b> 2 doors 71.1 cm 2 adjustable shelves	UDU 80 72 55 70		▲	275	287	316	458	554	599	671	738	-
			UDU 90 72 55 70		▲	275	287	316	458	554	599	672	739	-
			UDU 100 72 55 70		▲	288	301	342	482	554	599	676	744	-
			UDU 120 72 55 70		▲	332	354	404	576	654	711	801	881	-
⚠ Note: Door hinged front left = door hinged rear right. Always from the perspective of standing in front of the unit. Please order additional doors for the rear side.														
126 581		<b>Base unit as pass-through</b> 1 panel 12.6 cm attached to 1 door 58.1 cm connected 2 adjustable shelves	UDU 45 72 55 60	R/L	▲	204	215	241	304	320	345	373	410	-
			UDU 50 72 55 60	R/L	▲	204	215	241	304	345	369	412	453	-
			UDU 60 72 55 60	R/L	▲	244	255	276	348	399	426	474	521	-
			⚠ Note: Door hinged front left = door hinged rear right. Always from the perspective of standing in front of the unit. Please order additional doors for the rear side.											
126 581		<b>Base unit as pass-through</b> 2 panels 12.6 cm with 2 doors 58.1 cm 2 adjustable shelves	UDU 80 72 55 60		▲	275	287	316	458	554	599	671	738	-
			UDU 90 72 55 60		▲	275	287	316	458	554	599	672	739	-
			UDU 100 72 55 60		▲	288	301	342	482	554	599	676	744	-
			UDU 120 72 55 60		▲	332	354	404	576	654	711	801	881	-
⚠ Note: Door hinged front left = door hinged rear right. Always from the perspective of standing in front of the unit. Please order additional doors for the rear side.														
126 581		<b>Base unit as pass-through</b> 1 drawer 12.6 cm 1 door 58.1 cm 1 adjustable shelf	UDU 45 72 55 10	R/L	▲	261	268	298	369	401	423	460	506	-
			UDU 50 72 55 10	R/L	▲	261	268	298	369	401	425	466	513	-
			UDU 60 72 55 10	R/L	▲	294	304	343	416	448	478	524	576	-
			⚠ Note: Door hinged front left = door hinged rear right. Always from the perspective of standing in front of the unit. Please order additional doors for the rear side.											

## Base units as pass-throughs 71.5 cm high

Carcase depth 55.5 cm (standard)

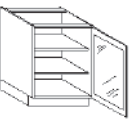

▲ = Types also available with 61 cm carcass depth (order no. ... replace ... 55 ... with 61)

		Order no.			Hinge side:	Carcass depth	Price groups								
		W	H	D			1	2	3	4	5	6	7	8	9
126 581		<b>Base unit as pass-through</b>													
		2 drawers 12.6 cm		UDU	80 72 55 18	▲	395	413	437	597	663	707	781	859	-
		2 doors 58.1 cm		UDU	90 72 55 18	▲	395	413	440	599	663	707	783	861	-
		1 adjustable shelf		UDU	100 72 55 18	▲	414	426	457	620	663	707	784	862	-
				UDU	120 72 55 18	▲	458	485	528	717	776	827	918	1010	-
				 <b>Note:</b> Door hinged front left = door hinged rear right. Always from the perspective of standing in front of the unit. Please order additional doors for the rear side.											
711		<b>Base unit door</b>													
		With fitting drill hole		E-TUO	20 72	R/L	52	54	73	105	129	170	186	205	-
		Without fitting,		E-TUO	25 72	R/L	58	68	85	117	147	184	204	224	-
		Height: 711 mm		E-TUO	30 72	R/L	60	77	98	129	161	207	227	250	-
				E-TUO	40 72	R/L	70	101	120	157	209	251	275	303	-
				E-TUO	45 72	R/L	72	111	133	169	228	281	306	337	-
		E-TUO	50 72	R/L	83	122	144	180	250	301	331	364	-		
		E-TUO	60 72	R/L	84	144	166	207	288	363	398	438	-		
581		<b>Base unit door</b>													
		With fitting drill hole		E-TUO	40 59	R/L	54	71	86	118	157	190	210	231	-
		Without fitting,		E-TUO	45 59	R/L	60	77	96	128	169	207	227	250	-
		Height: 581 mm		E-TUO	50 59	R/L	63	86	103	137	181	223	246	271	-
		E-TUO	60 59	R/L	66	100	118	156	209	250	271	298	-		
126		<b>Fixed panel</b>													
		Height: 126 mm		E-BF	40 13		49	50	52	76	105	112	121	133	-
				E-BF	45 13		50	51	53	78	109	114	123	135	-
				E-BF	50 13		51	52	54	83	113	120	131	144	-
		E-BF	60 13		53	54	59	87	118	133	144	158	-		

## Base units with glass door 71.5 cm high neutral

Carcass depth 55.5 cm (standard)

■ = Models also available in 34/45,5/61 cm carcass depth (Order no.: ... replace ... 55 ... with 34/45/61)

		Order no.			Hinge side:	Carcass depth	Glass groups							
		W	H	D			G1	G2	G2S	G5S	G6			
711		<b>Base unit with glass front</b>												
		-neutral-		UGD	45 72 55	R/L	■	-	485	-	-	-	-	-
		1 glass door 71.1 cm		UGD	50 72 55	R/L	■	-	518	-	-	-	-	-
		2 adjustable glass shelves		UGD	60 72 55	R/L	■	-	561	-	-	-	-	-
		 <b>Note:</b> For carcass depth 34 cm with wall mounting.												
		<b>G 1</b>		<b>G 2</b>		<b>G 2S</b>								
		<b>G 5</b>		<b>G 5S</b>		<b>G 6</b>								
		<b>G1 AKTIVglass frame</b> 991 Matt glass 992 Translucent black glass		<b>G2 Design front</b> 925 Frame White Agate/Matt glass 935 Premium W. Frame/Matt Glass 940 Macaron Col. Frame/Matt Glass 95 Light grey frame/matt glass 96 Silver Col. Frame/Matt Glass 960 Snow White Frame/Matt Glass 97 Black frame/black glass		<b>G2S aluminium, framed glass door</b> 988 aluminium black, Linea glass 994 Aluminium frame/clear glass 995 aluminium frame/black glass								
		996 aluminium, door with mullion 996 Alum.frame/clear gl./cross bar		<b>G6 NEW SALON</b> 986 aluminium black, black glass 987 aluminium black, clear glass 989 aluminium matt, bronze-coloured black glass 990 aluminium matt, bronze-coloured clear glass										

## Additional equipment

		Order no.			Hinge side:	Carcass depth	Decor groups								
		W	H	D			M10	M20	M30	M40	M50	M60	M70	M80	M90
		<b>Surcharge for bas cabinets with glass fronts inside and exterior in the same design</b>		IDF-U											
		available in decor groups: S/B/H/MP/F/Z													
		<b>M 10</b>		<b>M 20</b>		<b>M 30</b>		<b>M 40</b>		<b>M 50</b>					
		K M10 laminate								B M50 Velvet lacquer S M50 microstructure lacquer					
		<b>M 60</b>		<b>M 70</b>		<b>M 80</b>		<b>M 90</b>							
		F M70 veneer / oak / walnut Z M70 Veneer / Bavaria		H M80 high gloss-Lacquer MP M80 laqué mat Premium											

# Oven housings 71.5 cm high

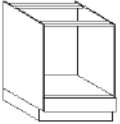
Carcase depth 55.5 cm (standard)

Please follow the fitting instructions from the appliance manufacturers.  
 ▲ = Types also available with 61 cm carcass depth (order no. ... replace ... 55 ... with 61)

Order no.  
 W H D

Hinge side:	Carcass depth	Price groups									
		1	2	3	4	5	6	7	8	9	
		▲	161	162	171	180	180	199	217	239	-
		▲	273	278	287	298	300	304	323	355	-
			17,10								
		▲	270	271	282	298	298	304	323	355	-
		▲	361	363	371	393	393	400	407	448	-

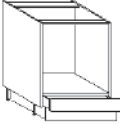
**106 Oven housing**  
 1 fixed panel 10.6 cm



<b>UH 60 72 55 85</b>	
-----------------------	--

Note: When planning with induction hotplates please take into account the specifications of the manufacturer for the thickness of the worktop. When fronts are laminate-coated, do not forget heat shields. (Model HP..)

**106 Oven housing**  
 1 spacious drawer with panel 10.6 cm high



**PTO**  
**NZ**

<b>UH 60 72 55 12</b>	
-----------------------	--

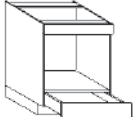
Note: When planning with induction hotplates please take into account the specifications of the manufacturer for the thickness of the worktop. When fronts are laminate-coated, do not forget heat shields. (Model HP..)  
 For use only as a slot-in solution or in conjunction with 1 base support panel.  
 Minimum plinth height: 10 cm  
 Only available with laminate drawer.

**Heat shields**  
 to protect fronts adjacent to oven  
 silver-coloured  
 price per pair



<b>HP/C</b>	
-------------	--

**126 Base unit for microwave**  
 1 fixed panel  
 1 open aperture 45 cm  
 1 drawer 12.6 cm

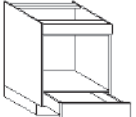


**45,0**

<b>UM 60 72 55 83</b>	
-----------------------	--

Note: Please indicate appliance type and manufacturer when ordering.

**126 Base unit for microwave**  
 1 fixed panel  
 1 open aperture 47.5 cm  
 1 drawer 12.6 cm  
 with full-width panel



**47,5**

<b>UM 90 72 55 83</b>	
-----------------------	--

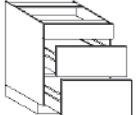
Note: Please indicate appliance type and manufacturer when ordering.

## Hob base units 71.5 cm high

Carcass depth 55.5 cm (standard)

Please follow the fitting instructions from the appliance manufacturers. ▲ = Types also available with 61 cm carcass depth (order no. ... replace ... 55 ... with 61)

**126 Hob base unit**  
 1 panel 12.6 cm  
 1 cable protective shelf  
 1 pull-out 25.6 cm  
 1 pull-out 32.1 cm

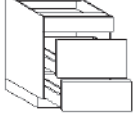


<b>UK 60 72 55 82</b>	▲	446	460	501	582	582	615	666	733	-
<b>UK 70 72 55 82</b>	▲	713	732	816	844	856	906	1005	1106	-
<b>UK 80 72 55 82</b>	▲	713	732	816	844	856	906	1005	1106	-
<b>UK 90 72 55 82</b>	▲	713	732	816	844	856	906	1005	1106	-
<b>UK 100 72 55 82</b>	▲	739	763	851	881	897	948	1050	1155	-
<b>UK 120 72 55 82</b>	▲	766	792	886	919	932	990	1097	1207	-

**Cutout for control panel**

<b>UK-AA</b>		22,80								
--------------	--	-------	--	--	--	--	--	--	--	--

**126 Hob base unit**  
 1 panel 12.6 cm  
 1 cable protective shelf  
 1 pull-out 32.1 cm  
 1 pull-out 25.6 cm

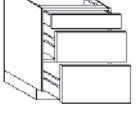


<b>UK 60 72 55 820</b>	▲	446	460	501	582	582	615	666	733	-
<b>UK 70 72 55 820</b>	▲	713	732	816	844	856	906	1005	1106	-
<b>UK 80 72 55 820</b>	▲	713	732	816	844	856	906	1005	1106	-
<b>UK 90 72 55 820</b>	▲	713	732	816	844	856	906	1005	1106	-
<b>UK 100 72 55 820</b>	▲	739	763	851	881	897	948	1050	1155	-
<b>UK 120 72 55 820</b>	▲	766	792	886	919	932	990	1097	1207	-

**Cutout for control panel**

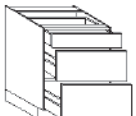
<b>UK-AA</b>		22,80								
--------------	--	-------	--	--	--	--	--	--	--	--

**126 Hob base unit**  
 1 drawer 12.6 cm  
 with low frame  
 1 cable protective shelf  
 1 pull-out 25.6 cm  
 1 pull-out 32.1 cm



<b>UKI 60 72 55 12</b>	▲	570	578	625	692	692	720	777	855	-
<b>UKI 70 72 55 12</b>	▲	848	861	943	1026	1038	1090	1189	1308	-
<b>UKI 80 72 55 12</b>	▲	848	861	943	1026	1038	1090	1189	1308	-
<b>UKI 90 72 55 12</b>	▲	848	861	943	1026	1038	1090	1189	1308	-
<b>UKI 100 72 55 12</b>	▲	872	893	977	1065	1080	1133	1235	1359	-
<b>UKI 120 72 55 12</b>	▲	899	934	1014	1102	1115	1173	1282	1410	-

**126 Hob base unit**  
 1 drawer 12.6 cm  
 with low frame  
 45.5 cm deep  
 1 cable protective shelf  
 1 pull-out 25.6 cm  
 1 pull-out 32.1 cm



<b>UKI 60 72 55 13</b>	▲	570	578	625	692	692	720	777	855	-
<b>UKI 70 72 55 13</b>	▲	848	861	943	1026	1038	1090	1189	1308	-
<b>UKI 80 72 55 13</b>	▲	848	861	943	1026	1038	1090	1189	1308	-
<b>UKI 90 72 55 13</b>	▲	848	861	943	1026	1038	1090	1189	1308	-
<b>UKI 100 72 55 13</b>	▲	872	893	977	1065	1080	1133	1235	1359	-
<b>UKI 120 72 55 13</b>	▲	899	934	1014	1102	1115	1173	1282	1410	-

Note: Cutlery organisers are not available for this article.





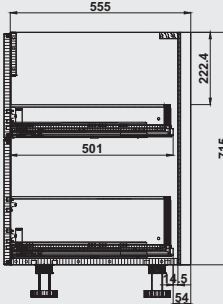

# Hob base units 71.5 cm high

Carcase depth 55.5 cm (standard)

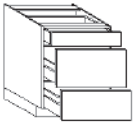
Please follow the fitting instructions from the appliance manufacturers.

▲ = Types also available with 61 cm carcass depth (order no. ... replace ... 55 ... with 61)

Order no.  
W H D

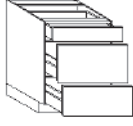
Hinge side:	Carcass depth	Price groups									
		1	2	3	4	5	6	7	8	9	
▲	55.5	UKI 60 72 55 120	570	578	625	692	692	720	777	855	-
		UKI 70 72 55 120	848	861	943	1026	1038	1090	1189	1308	-
		UKI 80 72 55 120	848	861	943	1026	1038	1090	1189	1308	-
		UKI 90 72 55 120	848	861	943	1026	1038	1090	1189	1308	-
		UKI 100 72 55 120	872	893	977	1065	1080	1133	1235	1359	-
		UKI 120 72 55 120	899	934	1014	1102	1115	1173	1282	1410	-
▲	55.5	UKI 60 72 55 121	570	578	625	692	692	720	777	855	-
		UKI 70 72 55 121	848	861	943	1026	1038	1090	1189	1308	-
		UKI 80 72 55 121	848	861	943	1026	1038	1090	1189	1308	-
		UKI 90 72 55 121	848	861	943	1026	1038	1090	1189	1308	-
		UKI 100 72 55 121	872	893	977	1065	1080	1133	1235	1359	-
		UKI 120 72 55 121	899	934	1014	1102	1115	1173	1282	1410	-
 <b>Note:</b> Cutlery organisers are not available for this article.											
▲	55.5	UKI 60 72 55 4	650	656	705	770	770	797	854	939	-
		UKI 80 72 55 4	949	965	1044	1127	1137	1189	1289	1418	-
		UKI 90 72 55 4	956	970	1050	1132	1143	1196	1294	1423	-
		UKI 100 72 55 4	996	1015	1101	1186	1199	1254	1356	1492	-
		UKI 120 72 55 4	1045	1071	1160	1248	1259	1317	1428	1571	-
▲	55.5	UKI 60 72 55 41	650	656	705	770	770	797	854	939	-
		UKI 80 72 55 41	949	965	1044	1127	1137	1189	1289	1418	-
		UKI 90 72 55 41	956	970	1050	1132	1143	1196	1294	1423	-
		UKI 100 72 55 41	996	1015	1101	1186	1199	1254	1356	1492	-
		UKI 120 72 55 41	1045	1071	1160	1248	1259	1317	1428	1571	-
 <b>Note:</b> Cutlery organisers are not available for this article.											
▲	55.5	UKI 60 72 55 40	650	656	705	770	770	797	854	939	-
		UKI 80 72 55 40	949	965	1044	1127	1137	1189	1289	1418	-
		UKI 90 72 55 40	956	970	1050	1132	1143	1196	1294	1423	-
		UKI 100 72 55 40	996	1015	1101	1186	1199	1254	1356	1492	-
		UKI 120 72 55 40	1045	1071	1160	1248	1259	1317	1428	1571	-
▲	55.5	UKI 60 72 55 42	650	656	705	770	770	797	854	939	-
		UKI 80 72 55 42	949	965	1044	1127	1137	1189	1289	1418	-
		UKI 90 72 55 42	956	970	1050	1132	1143	1196	1294	1423	-
		UKI 100 72 55 42	996	1015	1101	1186	1199	1254	1356	1492	-
		UKI 120 72 55 42	1045	1071	1160	1248	1259	1317	1428	1571	-
 <b>Note:</b> Cutlery organisers are not available for this article.											
▲	55.5	UDK 80 72 55 020	734	748	833	917	931	983	1079	1187	-
		UDK 90 72 55 020	734	748	833	917	931	983	1079	1187	-
		UDK 100 72 55 020	752	767	853	942	956	1009	1111	1222	-
		UDK 120 72 55 020	767	788	877	966	983	1040	1140	1254	-
		 <b>Note:</b> The pull-outs are adapted to the respective hob extractor type. We will not assume any liability for damage caused by moisture.									
											
▲	55.5	UDK 70 72 55 028	849	862	947	1030	1045	1096	1194	1313	-
		UDK 80 72 55 028	849	862	947	1030	1045	1096	1194	1313	-
		UDK 90 72 55 028	849	862	947	1030	1045	1096	1194	1313	-
		UDK 100 72 55 028	867	885	970	1056	1068	1126	1222	1344	-
		UDK 120 72 55 028	886	903	993	1083	1094	1150	1254	1379	-
 <b>Note:</b> The pull-outs are adapted to the respective hob extractor type. We will not assume any liability for damage caused by moisture.											

126  
321  
256



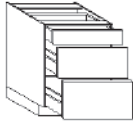
**Hob base unit**  
1 drawer 12.6 cm  
with low frame  
1 cable protective shelf  
1 pull-out 32.1 cm  
1 pull-out 25.6 cm

126  
321  
256



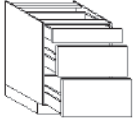
**Hob base unit**  
1 drawer 12.6 cm  
with low frame  
45.5 cm deep  
1 cable protective shelf  
1 pull-out 32.1 cm  
1 pull-out 25.6 cm

126  
321  
256



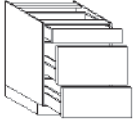
**Hob base unit for induction hobs**  
1 drawer 12.6 cm  
with low frame  
1 heat shield  
1 pull-out 25.6 cm  
1 pull-out 32.1 cm

126  
321  
256



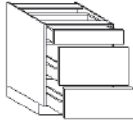
**Hob base unit for induction hobs**  
1 drawer 12.6 cm  
with low frame  
45.5 cm deep  
1 heat shield  
1 pull-out 25.6 cm  
1 pull-out 32.1 cm

126  
321  
256



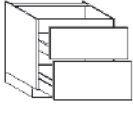
**Hob base unit for induction hobs**  
1 drawer 12.6 cm  
with low frame  
1 heat shield  
1 pull-out 32.1 cm  
1 pull-out 25.6 cm

126  
321  
256



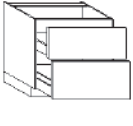
**Hob base unit for induction hobs**  
1 drawer 12.6 cm  
with low frame  
45.5 cm deep  
1 heat shield  
1 pull-out 32.1 cm  
1 pull-out 25.6 cm

321  
386



**Hob base unit for hob extractor**  
1 fixed inside panel  
1 drawer 32.1 cm  
1 pull-out 38.6 cm

321  
386



**Hob base unit for hob extractor**  
1 fixed inside panel  
1 drawer 32.1 cm  
with wooden rear panel  
1 pull-out 38.6 cm  
with wooden rear panel

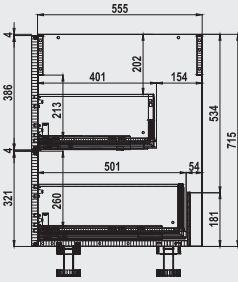
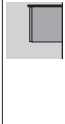
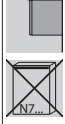
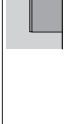
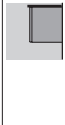
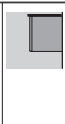
# Sink carcasses 71.5 cm high

Carcase depth 55.5 cm (standard)

□ = Models also available in 45.5/61 cm carcass depth (order no.: replace ... 55 ... with 45/61)  
 ▲ = Types also available with 61 cm carcass depth (order no. ... replace ... 55 ... with 61)

Order no.  
W H D

Hinge side: Carcass depth	Price groups									
	1	2	3	4	5	6	7	8	9	
R/L ▲	US 40 72 55 701	199	214	229	287	322	340	374	411	-
	US 45 72 55 701	199	214	229	287	322	340	374	411	-
	US 50 72 55 701	204	215	230	288	323	349	378	416	-
	US 60 72 55 701	231	246	267	331	368	389	430	473	-
▲	US 80 72 55 701	267	280	308	440	507	547	610	671	-
	US 90 72 55 701	269	285	311	442	509	550	616	678	-
	US 100 72 55 701	287	299	329	472	515	553	620	682	-
	US 120 72 55 701	326	346	389	542	588	637	716	788	-
R/L □	US 30 72 55 702	176	188	207	261	299	319	354	389	-
	US 40 72 55 702	176	188	207	261	299	319	354	389	-
	US 45 72 55 702	176	188	207	261	299	319	354	389	-
	US 50 72 55 702	176	188	207	261	299	322	359	395	-
R/L □	US 60 72 55 702	207	218	239	304	340	364	403	443	-
□	US 80 72 55 702	230	245	270	407	474	509	573	630	-
	US 90 72 55 702	230	245	270	407	474	509	577	635	-
	US 100 72 55 702	244	257	288	427	474	509	578	636	-
	US 120 72 55 702	280	302	342	496	547	595	669	736	-
R/L ▲	US 40 72 55 601	199	214	229	287	322	340	374	411	-
	US 45 72 55 601	199	214	229	287	322	340	374	411	-
	US 50 72 55 601	204	215	230	288	323	349	378	416	-
	US 60 72 55 601	231	246	267	331	368	389	430	473	-
▲	US 80 72 55 601	267	280	308	440	507	547	610	671	-
	US 90 72 55 601	269	285	311	442	509	550	616	678	-
	US 100 72 55 601	287	299	329	472	515	553	620	682	-
	US 120 72 55 601	326	346	389	542	588	637	716	788	-
R/L □	US 30 72 55 602	176	188	207	261	299	319	354	389	-
	US 40 72 55 602	176	188	207	261	299	319	354	389	-
	US 45 72 55 602	176	188	207	261	299	319	354	389	-
	US 50 72 55 602	176	188	207	261	299	322	359	395	-
R/L □	US 60 72 55 602	207	218	239	304	340	364	403	443	-
□	US 80 72 55 602	230	245	270	407	474	509	573	630	-
	US 90 72 55 602	230	245	270	407	474	509	577	635	-
	US 100 72 55 602	244	257	288	427	474	509	578	636	-
	US 120 72 55 602	280	302	342	496	547	595	669	736	-
▲	US 70 72 55 026	881	896	979	1064	1078	1131	1229	1352	-
	US 80 72 55 026	881	896	979	1064	1078	1131	1229	1352	-
	US 90 72 55 026	881	896	979	1064	1078	1131	1229	1352	-
	US 100 72 55 026	898	913	1002	1089	1102	1158	1259	1385	-
	US 120 72 55 026	911	935	1026	1115	1130	1185	1290	1419	-



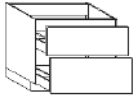


# Sink carcasses 71.5 cm high

Carcase depth 55.5 cm (standard)

□ = Models also available in 45.5/61 cm carcass depth (order no.: replace ... 55 ... with 45/61)  
 ▲ = Types also available with 61 cm carcass depth (order no. ... replace ... 55 ... with 61)

321  
386



## Sink carcass

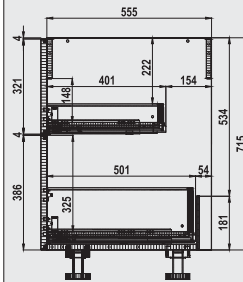
1 pull-out 32.1 cm, 45.5 cm deep  
 with full-width panel  
 with wooden rear panel reduced in height  
 1 moulded part for drain set  
 1 pull-out 38.6 cm with full-width panel

Order no.  
W H D

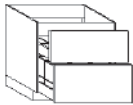
US 70 72 55 028  
 US 80 72 55 028  
 US 90 72 55 028  
 US 100 72 55 028  
 US 120 72 55 028

Hinge side:	Carcass depth	Price groups								
		1	2	3	4	5	6	7	8	9

▲	881	896	979	1064	1078	1131	1229	1352	-
▲	881	896	979	1064	1078	1131	1229	1352	-
▲	881	896	979	1064	1078	1131	1229	1352	-
▲	898	913	1002	1089	1102	1158	1259	1385	-
▲	911	935	1026	1115	1130	1185	1290	1419	-



321  
386

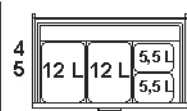
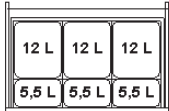
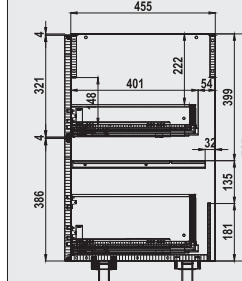
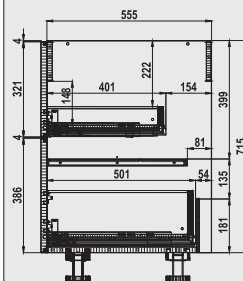


## Sink carcass

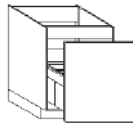
1 drawer 32.1 cm, 45.5 cm deep  
 with full-width panel  
 with wooden rear panel reduced in height  
 1 moulded part for drain set  
 1 pull-out 38.6 cm  
 with full-width panel  
 1 waste system in bottom pull-out

US 80 72 55 027  
 US 90 72 55 027  
 US 100 72 55 027  
 US 120 72 55 027

□	1253	1267	1353	1427	1442	1494	1592	1751	-
□	1256	1270	1357	1430	1445	1497	1595	1755	-
□	1278	1299	1385	1464	1479	1531	1636	1800	-
▲	1310	1333	1423	1504	1519	1574	1679	1847	-



711



## Sink carcass

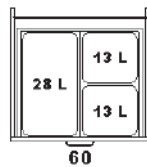
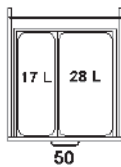
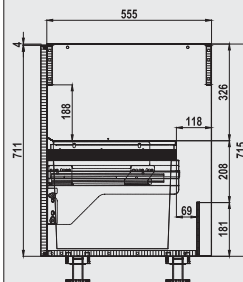
1 pull-out with front panel 71.1 cm  
 with frame and waste bin for hanging  
 1 inside panel

US 45 72 55 95  
 US 50 72 55 95  
 US 60 72 55 95

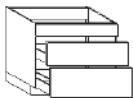
▲	553	569	583	643	677	694	730	803	-
▲	559	576	588	649	684	708	739	813	-
▲	606	621	642	707	743	764	805	886	-



Not available with TIP-ON Blumotion



126  
256  
321

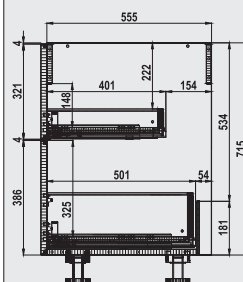


## Sink carcass

1 full-width panel 12.6 cm  
 1 drawer 25.6 cm, 45.5 cm deep  
 with full-width panel  
 1 moulded part for drain set  
 1 pull-out 32.1 cm with full width panel

US 70 72 55 826  
 US 80 72 55 826  
 US 90 72 55 826  
 US 100 72 55 826  
 US 120 72 55 826

▲	856	873	962	986	1003	1049	1150	1265	-
▲	856	873	962	986	1003	1049	1150	1265	-
▲	856	873	962	986	1003	1049	1150	1265	-
▲	872	897	983	1011	1024	1079	1182	1300	-
▲	901	924	1019	1047	1062	1118	1227	1350	-



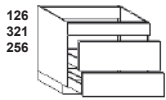
# Sink carcasses 71.5 cm high

Carcase depth 55.5 cm (standard)

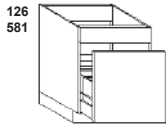
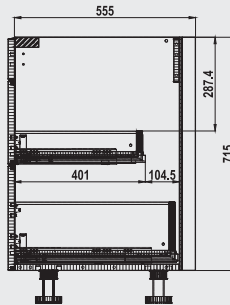
□ = Models also available in 45.5/61 cm carcass depth (order no.: replace ... 55 ... with 45/61)  
 ▲ = Types also available with 61 cm carcass depth (order no. ... replace ... 55 ... with 61)

Order no.  
W H D

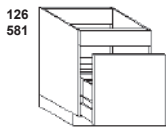
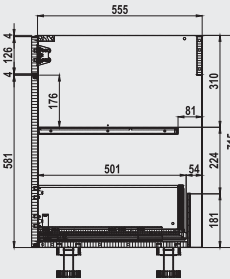
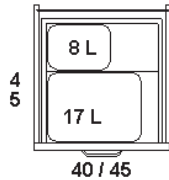
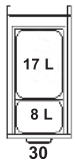
Hinge side: Carcass depth	Price groups									
	1	2	3	4	5	6	7	8	9	
▲	US 70 72 55 828	856	873	962	986	1003	1049	1150	1265	-
	US 80 72 55 828	856	873	962	986	1003	1049	1150	1265	-
	US 90 72 55 828	856	873	962	986	1003	1049	1150	1265	-
	US 100 72 55 828	872	897	983	1011	1024	1079	1182	1300	-
	US 120 72 55 828	901	924	1019	1047	1062	1118	1227	1350	-
▲	US 30 72 55 88	585	593	621	689	703	728	761	837	-
	US 40 72 55 88	585	593	621	689	703	728	761	837	-
	US 45 72 55 88	585	593	621	689	703	728	761	837	-
□	US 50 72 55 88	620	624	652	717	736	758	792	871	-
	US 60 72 55 88	648	658	700	758	776	796	831	914	-
▲	US 30 72 55 81	299	307	325	378	416	436	472	519	-
	US 40 72 55 81	299	307	325	378	416	436	472	519	-
	US 45 72 55 81	299	307	325	378	416	436	472	519	-
	US 50 72 55 81	299	307	325	378	416	439	476	524	-
	US 60 72 55 81	326	339	363	423	456	480	522	574	-



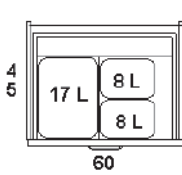
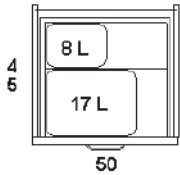
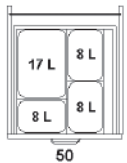
**Sink carcass**  
 1 full-width panel 12.6 cm  
 1 drawer 32.1 cm, 45.5 cm deep  
 with full-width panel  
 1 pull-out 25.6 cm with full width panel



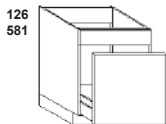
**Sink carcass**  
 1 panel 12.6 cm  
 1 pull-out 58.1 cm  
 with waste bins



**Sink carcass**  
 1 panel 12.6 cm  
 1 pull-out 58.1 cm  
 with waste bins

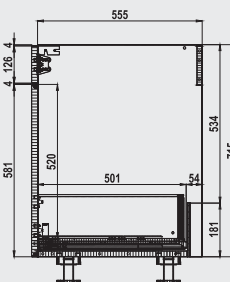


US 50 72 55 88  
 US 60 72 55 88



**Sink carcass**  
 1 panel 12.6 cm  
 1 pull-out 58.1 cm

US 30 72 55 81  
 US 40 72 55 81  
 US 45 72 55 81  
 US 50 72 55 81  
 US 60 72 55 81





# Sink carcasses 71.5 cm high

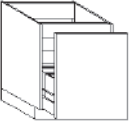
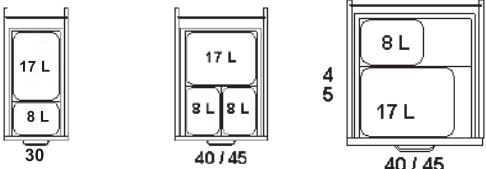
Carcase depth 55.5 cm (standard)



□ = Models also available in 45.5/61 cm carcass depth (order no.: replace ... 55 ... with 45/61)  
 ▲ = Types also available with 61 cm carcass depth (order no. ... replace ... 55 ... with 61)

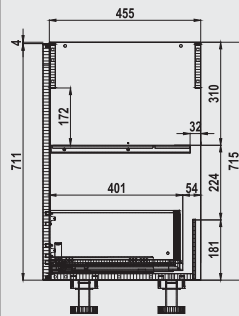
Order no.  
W H D

Hinge side:	Carcass depth	Price groups								
		1	2	3	4	5	6	7	8	9

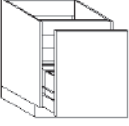
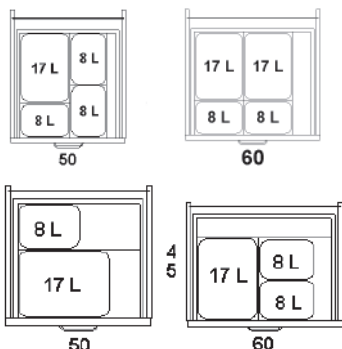
**711 Sink carcass**  
 1 inside panel  
 1 pull-out 71.1 cm  
 with waste bins






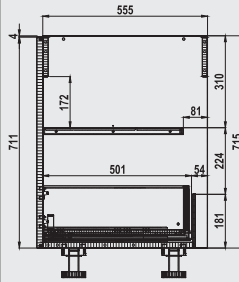
  Not available with TIP-ON	US 30 72 55 881	▲	585	593	621	689	703	728	761	837	-
	US 40 72 55 881	□	585	593	621	689	703	728	761	837	-
	US 45 72 55 881	□	585	593	621	689	703	728	761	837	-



**711 Sink carcass**  
 1 inside panel  
 1 pull-out 71.1 cm  
 with waste bins






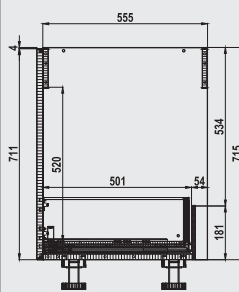
  Not available with TIP-ON	US 50 72 55 881	□	620	624	652	717	736	758	792	871	-
	US 60 72 55 881	□	648	658	700	758	776	796	831	914	-



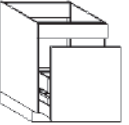
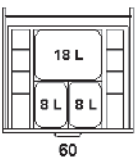
**711 Sink carcass**  
 1 inside panel  
 1 pull-out 71.1 cm



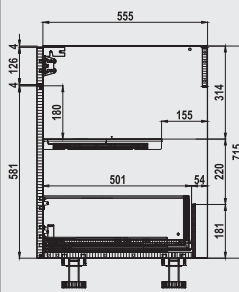
  Not available with TIP-ON	US 30 72 55 811	▲	299	307	325	378	416	436	472	519	-
	US 40 72 55 811	▲	299	307	325	378	416	436	472	519	-
	US 45 72 55 811	▲	299	307	325	378	416	436	472	519	-
	US 50 72 55 811	▲	299	307	325	378	416	439	476	524	-
	US 60 72 55 811	▲	326	339	363	423	456	480	522	574	-



**126 581 Sink carcass**  
 1 fixed panel 12.6 cm  
 1 pull-out with front panel 58.1 cm  
 with Hailo Separato-K waste separation system  
 with extendable lid

US 60 72 55 93	▲	533	545	568	629	661	686	726	799	-
----------------	---	-----	-----	-----	-----	-----	-----	-----	-----	---



# Sink carcasses 71.5 cm high

Carcase depth 55.5 cm (standard)

□ = Models also available in 45.5/61 cm carcass depth (order no.: replace ... 55 ... with 45/61)  
 ▲ = Types also available with 61 cm carcass depth (order no.: ... replace ... 55 ... with 61)

Order no.  
W H D

Hinge side: Carcass depth	Price groups								
	1	2	3	4	5	6	7	8	9
▲	533	545	568	629	661	686	726	799	-
▲	199	214	229	287	322	340	374	411	-
▲	204	215	230	288	323	349	378	416	-
▲	231	246	267	331	368	389	430	473	-
▲	199	214	229	287	322	340	374	411	-
▲	200	215	230	288	323	349	378	416	-
▲	231	246	267	331	368	389	430	473	-
▲	483	494	538	611	624	640	694	763	-
▲	483	494	538	611	624	640	694	763	-
□	731	739	785	853	866	881	936	1030	-
	34								

**711 Sink carcass**  
 1 inside panel  
 1 pull-out with front panel 71.1 cm  
 with Hailo Separato-K waste separation system  
 with extendable lid

**US 60 72 55 931**

**126 581 Sink carcass for waste bin**  
 1 panel 12.6 cm  
 1 front 58.1 cm, separate  
 1 aluminium protective shelf

**US 45 72 55 89**  
**US 50 72 55 89**  
**US 60 72 55 89**

**711 Sink carcass for waste bin**  
 1 inside panel  
 1 front 71.1 cm, separate  
 1 aluminium protective shelf

**US 45 72 55 79**  
**US 50 72 55 79**  
**US 60 72 55 79**

**386 321 Sink carcass**  
 1 pull-out 38.6 cm, 45.5 cm deep  
 with wooden rear panel  
 reduced in height 1 moulded part for drain set  
 1 pull-out 32.1 cm

**US 60 72 55 020**

**321 386 Sink carcass**  
 1 drawer 32.1 cm, 45.5 cm deep  
 1 moulded part for drain set  
 1 pull-out 38.6 cm

**US 60 72 55 022**

**321 386 Sink carcass**  
 1 drawer 32.1 cm, 45.5 cm deep  
 with wooden rear panel reduced in height  
 1 moulded part for drain set  
 1 pull-out 38.6 cm  
 1 waste system in bottom pull-out

**US 60 72 55 021**

Extra charge Sink carcass with full back panel

SA50SVR

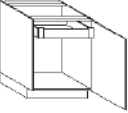
# Base units 71.5 cm high for water purifying, boiling and chilling systems

Carcase depth 55.5 cm (standard)


□ = Models also available in 45.5/61 cm carcass depth (order no.: replace ... 55 ... with 45/61)  
 ▲ = Types also available with 61 cm carcass depth (order no. ... replace ... 55 ... with 61)

Order no.  
W H D

Hinge side:	Carcass depth	Price groups								
		1	2	3	4	5	6	7	8	9
R/L ▲	422	438	453	511	546	563	598	658	-	
R/L ▲	485	500	522	585	622	643	685	754	-	

711  **Base unit for purifying, boiling and chilling water**  
 1 door 71.1 cm  
 1 internal drawer  
 with 1 Ambia-Line frame set for storing cartridges  
 1 aluminium protective shelf

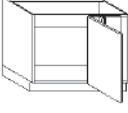
UWS	45	72	55	70	R/L ▲	422	438	453	511	546	563	598	658	-
UWS	60	72	55	70	R/L ▲	485	500	522	585	622	643	685	754	-

 **Note:** 54.5 cm clear installed height and 50.5 cm clear installed height for water purifying, boiling and chilling systems  
 Please follow the fitting instructions from the appliance manufacturers

## Corner base units Sink carcasses 71.5 cm high



Carcass depth 55.5 cm (standard)


□ = Models also available in 45.5/61 cm carcass depth (order no.: replace ... 55 ... with 45/61) ▲ = Types also available with 61 cm carcass depth (order no. ... replace ... 55 ... with 61)

711  **Corner sink base unit, variable**  
 Blind section left or right  
 1 inside panel  
 1 door 71.1 cm  
 Carcass width 100 cm with loose corner filler

*Ill. right*

Door 40 cm  
 Door 45 cm  
 Door 50 cm  
 Door 60 cm

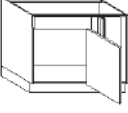
  **Note:** Items in ALU TEC RP model are only available with a fixed corner angle min. 6 x 6 cm. Handle N700/775: with fixed corner angle.

 **Not available for:**  
 ALU TEC RP

USE	105	72	55	7	R/L □	227	237	264	337	422	446	496	546	-
USE	110	72	55	7	R/L □	227	237	264	337	422	446	496	546	-
USE	115	72	55	7	R/L □	227	237	264	337	422	446	496	546	-
USE	125	72	55	7	R/L □	227	239	268	370	462	485	541	595	-



**Extra charge for extending corner filler width**


PLV						24,20	25,10	25,10	34	34	34	34	37	-
-----	--	--	--	--	--	-------	-------	-------	----	----	----	----	----	---

126 581  **Corner sink base unit, variable**  
 Blind section left or right  
 1 panel 12.6 cm  
 1 door 58.1 cm  
 Carcass width 100 cm with loose corner filler

*Ill. right*

Door 40 cm  
 Door 45 cm  
 Door 50 cm  
 Door 60 cm

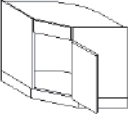
  **Note:** Items in ALU TEC RP model are only available with a fixed corner angle min. 6 x 6 cm. Handle N700/775: with fixed corner angle.

 **Not available for:**  
 ALU TEC RP


USE	105	72	55	8	R/L □	227	237	264	337	422	446	496	546	-
USE	110	72	55	8	R/L □	227	237	264	337	422	446	496	546	-
USE	115	72	55	8	R/L □	227	237	264	337	422	446	496	546	-
USE	125	72	55	8	R/L □	227	239	268	370	462	485	541	595	-

**Extra charge for extending corner filler width**

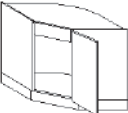
PLV						24,20	25,10	25,10	34	34	34	34	37	-
-----	--	--	--	--	--	-------	-------	-------	----	----	----	----	----	---


126 581  **Diagonal sink base unit**  
 90 x 90 cm, inside depth 72.5 cm  
 1 panel 12.6 cm  
 1 door 58.1 cm high, 40 cm wide

 **USD 90 72 80**

 **Not available for:**  
 ALU TEC RP, MIAMI, VIVA

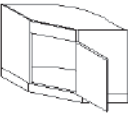
R/L	559	568	583	631	667	689	720	792	-
-----	-----	-----	-----	-----	-----	-----	-----	-----	---

711  **Diagonal sink base unit**  
 90 x 90 cm, inside depth 72.5 cm  
 1 door 71.1 cm high, 40 cm wide with 1 inside panel


 **USD 90 72 70**

 **Not available for:**  
 ALU TEC RP, MIAMI, VIVA

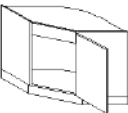
R/L	559	568	583	631	667	689	720	792	-
-----	-----	-----	-----	-----	-----	-----	-----	-----	---

126 581  **Diagonal sink base unit**  
 105 x 105 cm, inside depth 72.5 cm  
 1 panel 12.6 cm  
 1 door 58.1 cm high, 60 cm wide


 **USD 105 72 80**

 **Not available for:**  
 ALU TEC RP, MIAMI, VIVA

R/L	589	604	626	682	717	737	778	856	-
-----	-----	-----	-----	-----	-----	-----	-----	-----	---

711  **Diagonal sink base unit**  
 105 x 105 cm, inside depth 72.5 cm  
 1 door 71.1 cm high, 60 cm wide with 1 inside panel

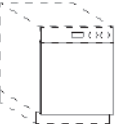
 **USD 105 72 70**


 **Not available for:**  
 ALU TEC RP, MIAMI, VIVA

R/L	589	604	626	682	717	737	778	856	-
-----	-----	-----	-----	-----	-----	-----	-----	-----	---

## Fronts for electrical appliances

Please specify the dishwasher item number when ordering.

581  **Base unit door, 58.1 cm**  
 as front panel for integrated dishwashers  
 44.6 cm wide with 45 cm  
 59.6 cm wide with 60 cm

 **Important!**  
 Only plan large-volume dishwashers with a plinth height of at least 15 cm.

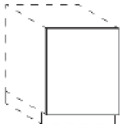
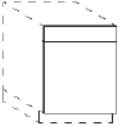
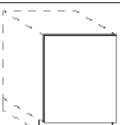
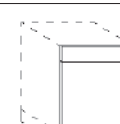
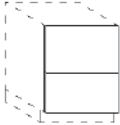
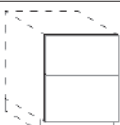
UT	45	59				70	74	89	112	149	163	181	199	-
UT	60	59				82	85	99	134	178	188	216	238	-

# Fronts for electrical appliances

Please specify the dishwasher item number when ordering.

Order no.  
W H D

Hinge side:	Carcass depth	Price groups								
		1	2	3	4	5	6	7	8	9

<p>711</p> 	<p><b>Base unit door, 71.1 cm</b> As front panel for fully integrated dishwashers and pull-out fridges and freezers 44.6 cm wide with 45 cm 59.6 cm wide with 60 cm</p>	<p><b>Important!</b> Only plan large-volume dishwashers with a plinth height of at least 15 cm.</p> <table border="1"> <tr> <td><b>UT 45 72 1</b></td> <td>96</td> <td>100</td> <td>108</td> <td>120</td> <td>186</td> <td>207</td> <td>244</td> <td>268</td> <td>-</td> </tr> <tr> <td><b>UT 60 72 1</b></td> <td>108</td> <td>112</td> <td>122</td> <td>134</td> <td>218</td> <td>236</td> <td>281</td> <td>309</td> <td>-</td> </tr> </table>	<b>UT 45 72 1</b>	96	100	108	120	186	207	244	268	-	<b>UT 60 72 1</b>	108	112	122	134	218	236	281	309	-																								
<b>UT 45 72 1</b>	96	100	108	120	186	207	244	268	-																																					
<b>UT 60 72 1</b>	108	112	122	134	218	236	281	309	-																																					
<p>126 581</p> 	<p><b>Base unit door, 71.1 cm</b> drawer panel 12.6 cm attached to door 58.1 cm As front panel for fully integrated dishwashers and pull-out fridges and freezers 44.6 cm wide with 45 cm <i>Surcharge in connection with the grip rails N700 and N775 incl. connecting plate and additional grip rails</i> 59.6 cm wide with 60 cm <i>Surcharge in connection with the grip rails N700 and N775 incl. connecting plate and additional grip rails</i></p>	<p><b>Important!</b> Only plan large-volume dishwashers with a plinth height of at least 15 cm.</p> <table border="1"> <tr> <td><b>UTV 45 72</b></td> <td>96</td> <td>100</td> <td>108</td> <td>120</td> <td>186</td> <td>207</td> <td>244</td> <td>268</td> <td>-</td> </tr> <tr> <td><b>Extra charge for MP-GSN...</b></td> <td>145</td> <td>145</td> <td>145</td> <td>145</td> <td>145</td> <td>145</td> <td>145</td> <td>145</td> <td>-</td> </tr> <tr> <td><b>UTV 60 72</b></td> <td>108</td> <td>112</td> <td>122</td> <td>134</td> <td>218</td> <td>236</td> <td>281</td> <td>309</td> <td>-</td> </tr> <tr> <td><b>Extra charge for MP-GSN...</b></td> <td>148</td> <td>148</td> <td>148</td> <td>148</td> <td>148</td> <td>148</td> <td>148</td> <td>148</td> <td>-</td> </tr> </table>	<b>UTV 45 72</b>	96	100	108	120	186	207	244	268	-	<b>Extra charge for MP-GSN...</b>	145	145	145	145	145	145	145	145	-	<b>UTV 60 72</b>	108	112	122	134	218	236	281	309	-	<b>Extra charge for MP-GSN...</b>	148	148	148	148	148	148	148	148	-				
<b>UTV 45 72</b>	96	100	108	120	186	207	244	268	-																																					
<b>Extra charge for MP-GSN...</b>	145	145	145	145	145	145	145	145	-																																					
<b>UTV 60 72</b>	108	112	122	134	218	236	281	309	-																																					
<b>Extra charge for MP-GSN...</b>	148	148	148	148	148	148	148	148	-																																					
<p>711</p> 	<p><b>Base unit door, 71.1 cm</b> for integrated built-under fridges with door and fully integrated washing machines 44.6 cm wide with 45 cm 59.6 cm wide with 60 cm</p>	<table border="1"> <tr> <td><b>UT 45 72 11</b></td> <td>R/L</td> <td>96</td> <td>100</td> <td>108</td> <td>120</td> <td>186</td> <td>207</td> <td>244</td> <td>268</td> <td>-</td> </tr> <tr> <td><b>UT 60 72 11</b></td> <td>R/L</td> <td>108</td> <td>112</td> <td>122</td> <td>134</td> <td>218</td> <td>236</td> <td>281</td> <td>309</td> <td>-</td> </tr> </table>	<b>UT 45 72 11</b>	R/L	96	100	108	120	186	207	244	268	-	<b>UT 60 72 11</b>	R/L	108	112	122	134	218	236	281	309	-																						
<b>UT 45 72 11</b>	R/L	96	100	108	120	186	207	244	268	-																																				
<b>UT 60 72 11</b>	R/L	108	112	122	134	218	236	281	309	-																																				
<p>126 581</p> 	<p><b>Base unit door, 71.1 cm</b> drawer panel 12.6 cm attached to door 58.1 cm for integrated built-under fridges with door and fully integrated washing machines 44.6 cm wide with 45 cm <i>Surcharge in connection with the grip rails N700 and N775 incl. connecting plate and additional grip rails</i> 59.6 cm wide with 60 cm <i>Surcharge in connection with the grip rails N700 and N775 incl. connecting plate and additional grip rails</i></p>	<table border="1"> <tr> <td><b>UTV 45 72 1</b></td> <td>R/L</td> <td>96</td> <td>100</td> <td>108</td> <td>120</td> <td>186</td> <td>207</td> <td>244</td> <td>268</td> <td>-</td> </tr> <tr> <td><b>Extra charge for MP-GSN...</b></td> <td></td> <td>145</td> <td>145</td> <td>145</td> <td>145</td> <td>145</td> <td>145</td> <td>145</td> <td>145</td> <td>-</td> </tr> <tr> <td><b>UTV 60 72 1</b></td> <td>R/L</td> <td>108</td> <td>112</td> <td>122</td> <td>134</td> <td>218</td> <td>236</td> <td>281</td> <td>309</td> <td>-</td> </tr> <tr> <td><b>Extra charge for MP-GSN...</b></td> <td></td> <td>148</td> <td>148</td> <td>148</td> <td>148</td> <td>148</td> <td>148</td> <td>148</td> <td>148</td> <td>-</td> </tr> </table>	<b>UTV 45 72 1</b>	R/L	96	100	108	120	186	207	244	268	-	<b>Extra charge for MP-GSN...</b>		145	145	145	145	145	145	145	145	-	<b>UTV 60 72 1</b>	R/L	108	112	122	134	218	236	281	309	-	<b>Extra charge for MP-GSN...</b>		148	148	148	148	148	148	148	148	-
<b>UTV 45 72 1</b>	R/L	96	100	108	120	186	207	244	268	-																																				
<b>Extra charge for MP-GSN...</b>		145	145	145	145	145	145	145	145	-																																				
<b>UTV 60 72 1</b>	R/L	108	112	122	134	218	236	281	309	-																																				
<b>Extra charge for MP-GSN...</b>		148	148	148	148	148	148	148	148	-																																				
<p>386 321</p> 	<p><b>Base unit door, 71.1 cm</b> split into 2 connected panels each of 38.6 cm and 32.1 cm attached As front panel for fully integrated dishwashers 44.6 cm wide with 45 cm <i>Surcharge in connection with the grip rails N700 and N775 incl. connecting plate and additional grip rails</i> 59.6 cm wide with 60 cm <i>Surcharge in connection with the grip rails N700 and N775 incl. connecting plate and additional grip rails</i></p>	<table border="1"> <tr> <td><b>UT 45 72 02</b></td> <td></td> <td>121</td> <td>124</td> <td>134</td> <td>148</td> <td>232</td> <td>259</td> <td>303</td> <td>333</td> <td>-</td> </tr> <tr> <td><b>Extra charge for MP-GSN...</b></td> <td></td> <td>145</td> <td>145</td> <td>145</td> <td>145</td> <td>145</td> <td>145</td> <td>145</td> <td>145</td> <td>-</td> </tr> <tr> <td><b>UT 60 72 02</b></td> <td></td> <td>134</td> <td>140</td> <td>154</td> <td>169</td> <td>273</td> <td>298</td> <td>352</td> <td>387</td> <td>-</td> </tr> <tr> <td><b>Extra charge for MP-GSN...</b></td> <td></td> <td>148</td> <td>148</td> <td>148</td> <td>148</td> <td>148</td> <td>148</td> <td>148</td> <td>148</td> <td>-</td> </tr> </table>	<b>UT 45 72 02</b>		121	124	134	148	232	259	303	333	-	<b>Extra charge for MP-GSN...</b>		145	145	145	145	145	145	145	145	-	<b>UT 60 72 02</b>		134	140	154	169	273	298	352	387	-	<b>Extra charge for MP-GSN...</b>		148	148	148	148	148	148	148	148	-
<b>UT 45 72 02</b>		121	124	134	148	232	259	303	333	-																																				
<b>Extra charge for MP-GSN...</b>		145	145	145	145	145	145	145	145	-																																				
<b>UT 60 72 02</b>		134	140	154	169	273	298	352	387	-																																				
<b>Extra charge for MP-GSN...</b>		148	148	148	148	148	148	148	148	-																																				
<p>321 386</p> 	<p><b>Base unit door, 71.1 cm</b> split into 2 connected panels each of 32.1 cm and 38.6 cm attached As front panel for fully integrated dishwashers 44.6 cm wide with 45 cm <i>Surcharge in connection with the grip rails N700 and N775 incl. connecting plate and additional grip rails</i> 59.6 cm wide with 60 cm <i>Surcharge in connection with the grip rails N700 and N775 incl. connecting plate and additional grip rails</i></p>	<table border="1"> <tr> <td><b>UT 45 72 020</b></td> <td></td> <td>121</td> <td>124</td> <td>134</td> <td>148</td> <td>232</td> <td>259</td> <td>303</td> <td>333</td> <td>-</td> </tr> <tr> <td><b>Extra charge for MP-GSN...</b></td> <td></td> <td>145</td> <td>145</td> <td>145</td> <td>145</td> <td>145</td> <td>145</td> <td>145</td> <td>145</td> <td>-</td> </tr> <tr> <td><b>UT 60 72 020</b></td> <td></td> <td>134</td> <td>140</td> <td>154</td> <td>169</td> <td>273</td> <td>298</td> <td>352</td> <td>387</td> <td>-</td> </tr> <tr> <td><b>Extra charge for MP-GSN...</b></td> <td></td> <td>148</td> <td>148</td> <td>148</td> <td>148</td> <td>148</td> <td>148</td> <td>148</td> <td>148</td> <td>-</td> </tr> </table>	<b>UT 45 72 020</b>		121	124	134	148	232	259	303	333	-	<b>Extra charge for MP-GSN...</b>		145	145	145	145	145	145	145	145	-	<b>UT 60 72 020</b>		134	140	154	169	273	298	352	387	-	<b>Extra charge for MP-GSN...</b>		148	148	148	148	148	148	148	148	-
<b>UT 45 72 020</b>		121	124	134	148	232	259	303	333	-																																				
<b>Extra charge for MP-GSN...</b>		145	145	145	145	145	145	145	145	-																																				
<b>UT 60 72 020</b>		134	140	154	169	273	298	352	387	-																																				
<b>Extra charge for MP-GSN...</b>		148	148	148	148	148	148	148	148	-																																				







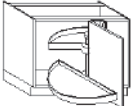


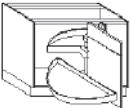


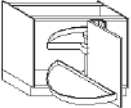


# Corner base units 71.5 cm high variable

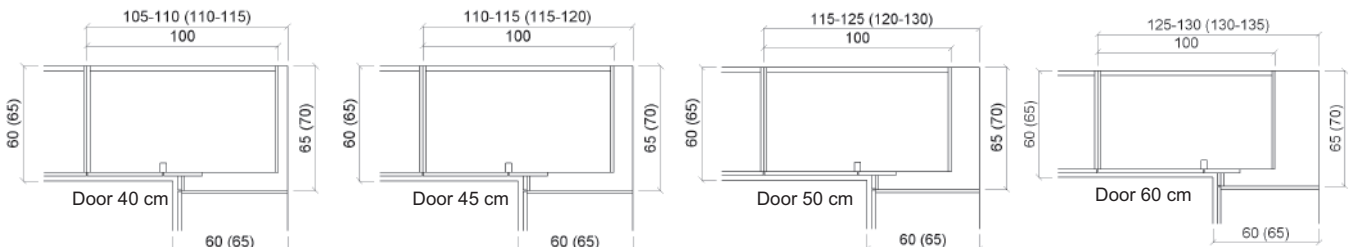
Carcase depth 55.5 cm (standard)

■ = Models also available in 34/45.5/61 cm carcass depth (Order no.: ... replace ... 55 ... with 34/45/61)  
 ▲ = Types also available with 61 cm carcass depth (order no. ... replace ... 55 ... with 61)

Order no.  
 W H D

Hinge side:	Carcass depth	Price groups								
		1	2	3	4	5	6	7	8	9

126 581  Ill. right <b>Corner base unit, variable</b> Blind section left or right 1 drawer 12.6 cm 1 door 58.1 cm 2 carousel shelves Carcase width 100 cm with loose corner filler  Door 45 cm Door 50 cm Door 60 cm  <b>Extra charge for extending corner filler width</b>	 <b>Note: Items in ALU TEC RP models only available with a fixed corner angle min. dimensions 6 x 6 cm! handle N700/775: with fixed corner angle</b>	UE 110 72 55 12	R/L ▲	329	343	373	448	535	563	615	677	-
		UE 115 72 55 12	R/L ▲	329	343	373	448	535	563	615	677	-
		UE 125 72 55 12	R/L ▲	329	346	375	485	573	604	657	723	-
		PLV		24,20	25,10	25,10	34	34	34	34	37	-
126 581  Ill. right <b>Corner base unit, variable</b> Blind section left or right 1 drawer 12.6 cm 1 door 58.1 cm 2 wooden carousel shelves with chrome-plated rail Carcase width 100 cm with loose corner filler  Door 45 cm Door 50 cm Door 60 cm  <b>Extra charge for extending corner filler width</b>	 <b>Note: Items in ALU TEC RP models only available with a fixed corner angle min. dimensions 6 x 6 cm! handle N700/775: with fixed corner angle</b>	UE 110 72 55 13	R/L ▲	418	432	462	537	621	651	700	770	-
		UE 115 72 55 13	R/L ▲	418	432	462	537	621	651	700	770	-
		UE 125 72 55 13	R/L ▲	418	436	465	571	658	690	743	817	-
		PLV		24,20	25,10	25,10	34	34	34	34	37	-
711  Ill. right <b>Corner base unit, variable</b> Blind section left or right 1 door 71.1 cm high 2 wooden carousel shelves with chrome-plated rail Carcase width 100 cm with loose corner filler  Door 45 cm Door 50 cm Door 60 cm  <b>Extra charge for extending corner filler width</b>	  <b>Note: Items in ALU TEC RP models only available with a fixed corner angle min. dimensions 6 x 6 cm! handle N700/775: with fixed corner angle</b>	UE 110 72 55 73	R/L ▲	383	398	423	498	582	611	658	724	-
		UE 115 72 55 73	R/L ▲	383	398	423	498	582	611	658	724	-
		UE 125 72 55 73	R/L ▲	383	401	427	535	621	650	703	773	-
		PLV		24,20	25,10	25,10	34	34	34	34	37	-
126 581  Ill. right <b>Corner base unit, variable</b> Blind section left or right 1 panel 12.6 cm attached to 1 door 58.1 cm, 2 wooden carousel shelves with chrome-plated rail Carcase width 100 cm with loose corner filler  Door 45 cm Door 50 cm Door 60 cm  <b>Extra charge for extending corner filler width</b>	  <b>Note: Items in ALU TEC RP models only available with a fixed corner angle min. dimensions 6 x 6 cm! handle N700/775: with fixed corner angle</b>	UE 110 72 55 63	R/L ▲	383	398	423	498	582	611	658	724	-
		UE 115 72 55 63	R/L ▲	383	398	423	498	582	611	658	724	-
		UE 125 72 55 63	R/L ▲	383	401	427	535	621	650	703	773	-
		PLV		24,20	25,10	25,10	34	34	34	34	37	-
711  Ill. right <b>Corner base unit, variable</b> Blind section left or right 1 door 71.1 cm 2 carousel shelves Carcase width 100 cm with loose corner filler  Door 45 cm Door 50 cm Door 60 cm	  <b>Note: Items in ALU TEC RP models only available with a fixed corner angle min. dimensions 6 x 6 cm! handle N700/775: with fixed corner angle</b>	UE 110 72 55 71	R/L ▲	298	310	338	413	496	526	572	629	-
		UE 115 72 55 71	R/L ▲	298	310	338	413	496	526	572	629	-
		UE 125 72 55 71	R/L ▲	298	312	341	447	535	562	618	680	-
		PLV										





# Corner base units 71.5 cm high variable

Carcase depth 55.5 cm (standard)


■ = Models also available in 34/45.5/61 cm carcass depth (Order no.: ... replace ... 55 ... with 34/45/61)  
 ▲ = Types also available with 61 cm carcass depth (order no. ... replace ... 55 ... with 61)


Order no.  
W H D

Hinge side:	Carcass depth	Price groups								
		1	2	3	4	5	6	7	8	9
		24,20	25,10	25,10	34	34	34	34	37	-

**Extra charge for extending corner filler width**

PLV

**126 581**  **Corner base unit, variable**  
 Blind section left or right  
 1 panel 12.6 cm attached to door 58.1 cm  
 2 carousel shelves  
 Carcase width 100 cm with loose corner filler

**PTO**  **Note: Items in ALU TEC RP models only available with a fixed corner angle min. dimensions 6 x 6 cm! handle N700/775: with fixed corner angle**

*Ill. right*

Door 45 cm  
 Door 50 cm  
 Door 60 cm

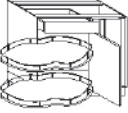
<b>UE 110 72 55 61</b>	R/L ▲	298	310	338	413	496	526	572	629	-
<b>UE 115 72 55 61</b>	R/L ▲	298	310	338	413	496	526	572	629	-
<b>UE 125 72 55 61</b>	R/L ▲	298	312	341	447	535	562	618	680	-

**Extra charge for extending corner filler width**

PLV


# Corner base units 71.5 cm high Le Mans

Carcass depth 55.5 cm (standard)

**126 581**  **Corner base unit „Le Mans“**  
 Blind section left or right  
 1 drawer 12.6 cm, 1 door 58.1 cm  
 2 wooden carousel shelves with chrome-plated rail  
 fully swivelling „Le Mans“  
 Carcase width 100 cm with loose corner filler

*Ill. right*

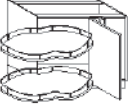
Door 45 cm  
 Door 50 cm  
 Door 60 cm

 **Note: Items in ALU TEC RP models only available with a fixed corner angle min. dimensions 6 x 6 cm! handle N700/775: with fixed corner angle Please allow for shelf turning space and 50 cm clearance for carousel shelves.**

<b>UE 110 72 55 14</b>	R/L ▲	928	935	967	1027	1107	1134	1185	1304	-
<b>UE 115 72 55 14</b>	R/L ▲	965	972	1001	1062	1142	1171	1220	1342	-
<b>UE 125 72 55 14</b>	R/L ▲	1012	1020	1052	1141	1226	1255	1309	1440	-


**Extra charge for extending corner filler width**

PLV

**711**  **Corner base unit „Le Mans“**  
 Blind section left or right  
 1 door 71.1 cm high  
 2 wooden carousel shelves with chrome-plated rail  
 fully swivelling „Le Mans“  
 Carcase width 100 cm with loose corner filler

*Ill. right*

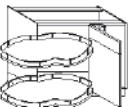
Door 45 cm  
 Door 50 cm  
 Door 60 cm


 **Note: Items in ALU TEC RP models only available with a fixed corner angle min. dimensions 6 x 6 cm! handle N700/775: with fixed corner angle Please allow for shelf turning space and 50 cm clearance for carousel shelves.**

<b>UE 110 72 55 74</b>	R/L ▲	897	903	933	991	1071	1098	1147	1262	-
<b>UE 115 72 55 74</b>	R/L ▲	931	940	969	1026	1107	1132	1182	1300	-
<b>UE 125 72 55 74</b>	R/L ▲	977	987	1019	1107	1188	1218	1271	1398	-

**Extra charge for extending corner filler width**

PLV

**126 581**  **Corner base unit „Le Mans“**  
 Blind section left or right  
 1 panel 12.6 cm attached to door 58.1 cm  
 2 wooden carousel shelves with chrome-plated rail  
 fully swivelling „Le Mans“  
 Carcase width 100 cm with loose corner filler

**PTO**  **Note: Items in ALU TEC RP models only available with a fixed corner angle min. dimensions 6 x 6 cm! handle N700/775: with fixed corner angle Please allow for shelf turning space and 50 cm clearance for carousel shelves.**

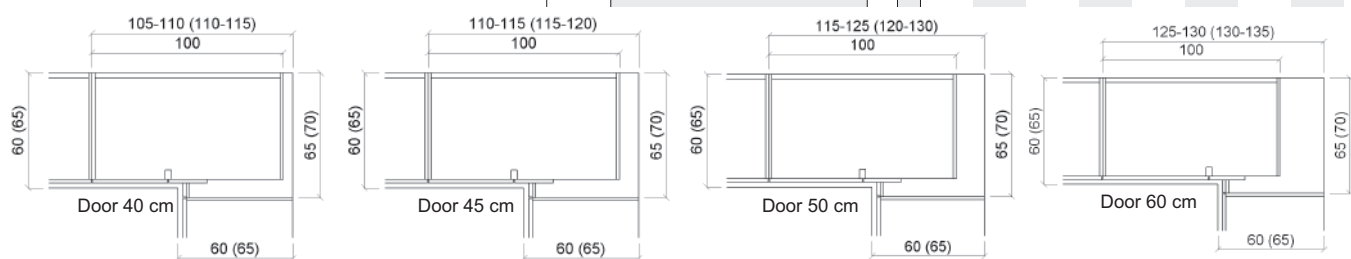
*Ill. right*

Door 45 cm  
 Door 50 cm  
 Door 60 cm

<b>UE 110 72 55 64</b>	R/L ▲	897	903	933	991	1071	1098	1147	1262	-
<b>UE 115 72 55 64</b>	R/L ▲	931	940	969	1026	1107	1132	1182	1300	-
<b>UE 125 72 55 64</b>	R/L ▲	977	987	1019	1107	1188	1218	1271	1398	-

**Extra charge for extending corner filler width**

PLV



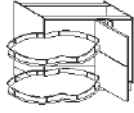





# Corner base units 71.5 cm high Le Mans

Carcase depth 55.5 cm (standard)

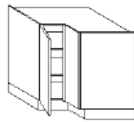

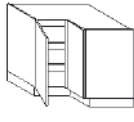

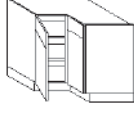

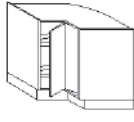

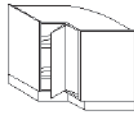

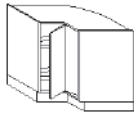

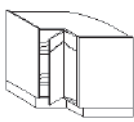

Hinge side:	Carcase depth	Price groups								
		1	2	3	4	5	6	7	8	9

Order no.  
W H D

<p>321 386</p>  <p>Blind section left or right 1 door consisting of 2 panels 32.1 cm and 38.6 cm attached 2 wooden carousel shelves with chrome-plated rail fully swivelling „Le Mans“ Carcase width 100 cm with loose corner filler Door 45 cm Door 50 cm Door 60 cm</p>	 <p>Note: Items in ALU TEC RP models only available with a fixed corner angle min. dimensions 6 x 6 cm! handle N700/775: with fixed corner angle Please allow for shelf turning space and 50 cm clearance for carousel shelves.</p>											
		UE 110 72 55 742	R/L ▲	897	903	933	991	1071	1098	1147	1262	-
		UE 115 72 55 742	R/L ▲	931	940	969	1026	1107	1132	1182	1300	-
		UE 125 72 55 742	R/L ▲	977	987	1019	1107	1188	1218	1271	1398	-
 <p>Cushioned self-closing mechanism for “Le Mans” carousel shelves</p>	 <p>Important! Version L = left suitable for unit types in the version L=left Version R = right suitable for unit types in the version R=right</p>	Z 142	R/L	41								

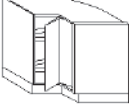
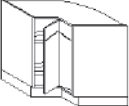
# Corner base units 71.5 cm high as carousel corner unit

Carcase depth 55.5 cm (standard)

711	 <p>Corner base unit with shelves side length 80 x 80 cm 2 adjustable shelves 2 doors 20 cm wide, 71.1 cm high (doors attached to front panels not possible) Right door with corner angle 4.2 cm x 4.2 cm</p>	 <p>UEB 80 72 70</p> <p>Not available for: ALU TEC RP, MIAMI, VIVA</p> <p>Models FRAME, VILLAGE 15-S, VILLAGE 15-B, OSLO 15, TESSIN 15, BERGEN, LUGANO, CASTELLO, VIVA, VINO, TIM 15 are supplied with smooth fronts.</p>		554	573	623	699	699	711	778	856	-
711	 <p>Corner base unit with shelves side length 90 x 90 cm 2 adjustable shelves 2 doors 30 cm wide, 71.1 cm high (doors attached to front panels not possible) Right door with corner angle 4.2 cm x 4.2 cm</p>	 <p>UEB 90 72 70</p> <p>Not available for: ALU TEC RP, MIAMI, VIVA</p>		554	573	623	699	699	711	778	856	-
126 581	 <p>Corner base unit with shelves side length 90 x 90 cm 2 adjustable shelves 2 panels 12.6 cm with 2 doors 58.1 cm 30 cm wide Right door with corner angle 4.2 cm x 4.2 cm</p>	 <p>UEB 90 72 60</p> <p>Not available for: ALU TEC RP, MIAMI, VIVA</p>		554	573	623	699	699	711	778	856	-
711	 <p>Corner base unit as carousel corner unit side length 80 x 80 cm 2 wooden carousel shelves with chrome-plated rail with 360° rotation mechanism 2 doors 20 cm wide, 71.1 cm high (doors attached to front panels not possible) Right door with corner angle 4.2 x 4.2 cm</p>	 <p>UEK 80 72 73</p> <p>model ALU TEC RP: The doors are different for technical reasons: left door 21.8 cm, right door 24.1 cm without corner angle. Models FRAME, VILLAGE 15-S, VILLAGE 15-B, OSLO 15, TESSIN 15, BERGEN, LUGANO, CASTELLO, VIVA, VINO, TIM 15 are supplied with smooth fronts.</p>		744	764	813	883	883	900	965	1062	-
711	 <p>Corner base unit as carousel corner unit side length 80 x 80 cm 2 carousel shelves with 360° rotation mechanism 2 doors 20 cm wide, 71.1 cm high (doors attached to front panels not possible) Right door with corner angle 4.2 x 4.2 cm</p>	 <p>UEK 80 72 72</p> <p>model ALU TEC RP: The doors are different for technical reasons: left door 21.8 cm, right door 24.1 cm without corner angle. Models FRAME, VILLAGE 15-S, VILLAGE 15-B, OSLO 15, TESSIN 15, BERGEN, LUGANO, CASTELLO, VIVA, VINO, TIM 15 are supplied with smooth fronts.</p>		554	573	623	699	699	711	778	856	-
711	 <p>Corner base unit as carousel corner unit side length 90 x 90 cm 2 wooden carousel shelves with chrome-plated rail with 360° rotation mechanism 2 doors 30 cm wide, 71.1 cm high Right door with corner angle 4.2 x 4.2 cm</p>	 <p>UEK 90 72 73</p> <p>Not available for: ALU TEC RP, MPX</p> <p>ALU TEC RP models: The doors are different for technical reasons: left door 31.8 cm, right door 34.1 cm without corner angle</p>		744	764	813	883	883	900	965	1062	-
126 581	 <p>Corner base unit as carousel corner unit side length 90 x 90 cm 2 wooden carousel shelves with chrome-plated rail with 360° rotation mechanism 2 panels 12.6 cm with 2 doors 58.1 cm 30 cm wide Right door with corner angle 4.2 x 4.2 cm</p>	 <p>UEK 90 72 63</p> <p>Not available for: ALU TEC RP</p> <p>Not available for: N700, N775</p>		744	764	813	883	883	900	965	1062	-

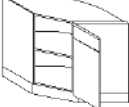
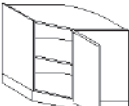
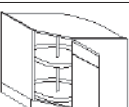
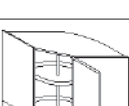
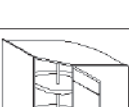


## Corner base units 71.5 cm high as carousel corner unit

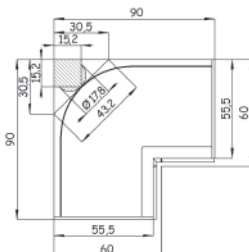
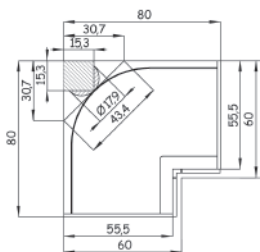
Carcase depth 55.5 cm (standard)

		Order no.		Price groups											
		W	H	D											
					Hinge side:	Carcase depth	1	2	3	4	5	6	7	8	9
711	 <p><b>Corner base unit as carousel corner unit</b> side length 90 x 90 cm 2 carousel shelves with 360° rotation mechanism 2 doors 30 cm wide, 71.1 cm high Right door with corner angle 4.2 x 4.2 cm</p>	<b>PTO</b>	<b>UEK 90 72 72</b>			554	573	623	699	699	711	778	856	-	
					Not available for:										
					ALU TEC RP, MPX										
					ALU TEC RP models:										
					The doors are different for technical reasons: left door 31.8 cm, right door 34.1 cm without corner angle										
126 581	 <p><b>Corner base unit as carousel corner unit</b> side length 90 x 90 cm 2 carousel shelves with 360° rotation mechanism Panel 12.6 cm with doors 58.1 cm attached, 30 cm wide Right door with corner angle 4.2 x 4.2 cm</p>	<b>PTO</b>	<b>UEK 90 72 62</b>			554	573	623	699	699	711	778	856	-	
					Not available for:										
					ALU TEC RP										
					Not available for:										
					N700, N775										

## Diagonal corner base unit 71.5 cm high

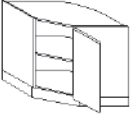

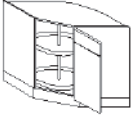

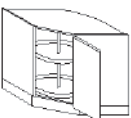

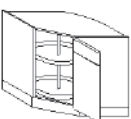

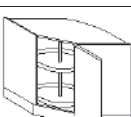

Carcase depth 55.5 cm (standard)

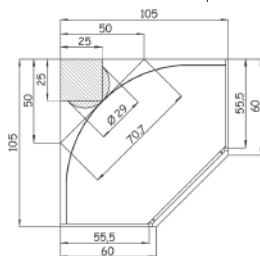
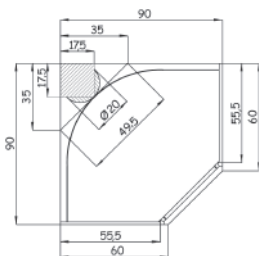
126 581	 <p><b>Diagonal corner base unit</b> 90 x 90 cm, inside depth 72.5 cm 1 panel 12.6 cm attached to 1 door 58.1 cm connected 40 cm wide 1 adjustable shelf</p>	<b>PTO</b>	<b>UED 90 72 60</b>	R/L	610	617	634	684	718	736	772	849	-	
					Not available for:									
					ALU TEC RP, MIAMI, VIVA									
711	 <p><b>Diagonal corner base unit</b> 90 x 90 cm, inside depth 72.5 cm 1 door 40 cm wide, 71.1 cm high 1 adjustable shelf</p>	<b>PTO</b>	<b>UED 90 72 70</b>	R/L	610	617	634	684	718	736	772	849	-	
					Not available for:									
					ALU TEC RP, MIAMI, VIVA									
126 581	 <p><b>Diagonal carousel corner base unit</b> 90 x 90 cm, inside depth 72.5 cm 1 panel 12.6 cm attached to 1 door 58.1 cm connected 40 cm wide 2 wooden carousel shelves with chrome-plated rail</p>	<b>PTO</b>	<b>UED 90 72 63</b>	R/L	863	870	887	931	967	982	1017	1119	-	
					Not available for:									
					ALU TEC RP, MIAMI, VIVA									
711	 <p><b>Diagonal carousel corner base unit</b> 90 x 90 cm, inside depth 72.5 cm 1 door 40 cm wide, 71.1 cm high 2 wooden carousel shelves with chrome-plated rail</p>	<b>PTO</b>	<b>UED 90 72 73</b>	R/L	863	870	887	931	967	982	1017	1119	-	
					Not available for:									
					ALU TEC RP, MIAMI, VIVA									
126 581	 <p><b>Diagonal carousel corner base unit</b> 90 x 90 cm, inside depth 72.5 cm 1 panel 12.6 cm attached to 1 door 58.1 cm connected 40 cm wide 2 carousel shelves</p>	<b>PTO</b>	<b>UED 90 72 62</b>	R/L	674	681	699	745	781	800	831	914	-	
					Not available for:									
					ALU TEC RP, MIAMI, VIVA									
711	 <p><b>Diagonal carousel corner base unit</b> 90 x 90 cm, inside depth 72.5 cm 1 door 40 cm wide, 71.1 cm high 2 carousel shelves</p>	<b>PTO</b>	<b>UED 90 72 72</b>	R/L	674	681	699	745	781	800	831	914	-	
					Not available for:									
					ALU TEC RP, MIAMI, VIVA									
126 581	 <p><b>Diagonal corner base unit</b> 105 x 105 cm, inside depth 72.5 cm 1 panel 12.6 cm attached to 1 door 58.1 cm connected 60 cm wide 1 adjustable shelf</p>	<b>PTO</b>	<b>UED 105 72 60</b>	R/L	641	649	674	727	761	784	823	905	-	
					Not available for:									
					ALU TEC RP, MIAMI, VIVA									



# Diagonal corner base unit 71.5 cm high

Carcase depth 55.5 cm (standard)

		Order no.		Hinge side:	Carcase depth	Price groups								
		W	H			D	1	2	3	4	5	6	7	8
711	 <p><b>Diagonal corner base unit</b> 105 x 105 cm, inside depth 72.5 cm 1 door 60 cm wide, 71.1 cm high 1 adjustable shelf</p>	<del>PTO</del>	<b>UED 105 72 70</b>	R/L	641	649	674	727	761	784	823	905	-	
		<p><del>Not available for:</del>   <del>ALU TEC RP, MIAMI, VIVA</del></p>												
126 581	 <p><b>Diagonal carousel corner base unit</b> 105 x 105 cm, inside depth 72.5 cm 1 panel 12.6 cm attached to 1 door 58.1 cm connected 60 cm wide 2 wooden carousel shelves with chrome-plated rail</p>	<del>PTO</del>	<b>UED 105 72 63</b>	R/L	896	905	925	973	1010	1035	1070	1177	-	
		<p><del>Not available for:</del>   <del>ALU TEC RP, MIAMI, VIVA</del></p>												
711	 <p><b>Diagonal carousel corner base unit</b> 105 x 105 cm, inside depth 72.5 cm 1 door 60 cm wide, 71.1 cm high 2 wooden carousel shelves with chrome-plated rail</p>	<del>PTO</del>	<b>UED 105 72 73</b>	R/L	896	905	925	973	1010	1035	1070	1177	-	
		<p><del>Not available for:</del>   <del>ALU TEC RP, MIAMI, VIVA</del></p>												
126 581	 <p><b>Diagonal carousel corner base unit</b> 105 x 105 cm, inside depth 72.5 cm 1 panel 12.6 cm attached to 1 door 58.1 cm connected 60 cm wide 2 carousel shelves</p>	<del>PTO</del>	<b>UED 105 72 62</b>	R/L	705	717	735	788	824	850	884	972	-	
		<p><del>Not available for:</del>   <del>ALU TEC RP, MIAMI, VIVA</del></p>												
711	 <p><b>Diagonal carousel corner base unit</b> 105 x 105 cm, inside depth 72.5 cm 1 door 60 cm wide, 71.1 cm high 2 carousel shelves</p>	<del>PTO</del>	<b>UED 105 72 72</b>	R/L	705	717	735	788	824	850	884	972	-	
		<p><del>Not available for:</del>   <del>ALU TEC RP, MIAMI, VIVA</del></p>												



# Base shelf units 71.5 cm high

Carcase depth 57.7 cm, flush with front

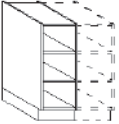
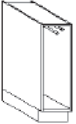

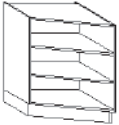
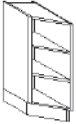
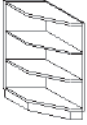
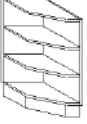

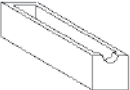
■ = Models also available in 36.1/47.7/63.2 cm carcass depth  
(Order no.: replace ... 58 ... with 36/48/63)

□ = Models also available in 47.7 cm carcass depth (order no.: replace ... 58 ... with 48)

Order no.

W H D

## Decor groups

	Hinge side:	Carcass depth	Decor groups										
			M10	M20	M30	M40	M50	M60	M70	M80	M90		
 <p><b>Base shelf unit</b> 2 adjustable shelves wide in cm: 13-30 wide in cm: 30,1-40 wide in cm: 40,1-45 wide in cm: 45,1-50 wide in cm: 50,1-60 wide in cm: 60,1-80 wide in cm: 80,1-90</p>	36,1 47,7 57,7 63,2	■	UR 30 72 58	■	204	-	-	-	708	-	708	708	-
			UR 40 72 58	■	204	-	-	-	708	-	708	708	-
			UR 45 72 58	■	204	-	-	-	708	-	708	708	-
			UR 50 72 58	■	204	-	-	-	708	-	708	708	-
			UR 60 72 58	■	204	-	-	-	708	-	708	708	-
			UR 80 72 58	■	229	-	-	-	801	-	1036	1036	-
			UR 90 72 58	■	229	-	-	-	801	-	1036	1036	-
 <p><b>Base shelf unit</b> 1 towel rails With 2 extendable rails wide in cm: 15 wide in cm: 20 wide in cm: 25</p>		▲	URH 15 72 58	▲	248	-	-	-	754	-	754	754	-
			URH 20 72 58	▲	248	-	-	-	754	-	754	754	-
			URH 25 72 58	▲	248	-	-	-	754	-	754	754	-
 <p><b>Base unit bottle shelf</b> wide in cm: 15 wide in cm: 30</p>		□	URFL 15 72 58	□	218	-	-	-	586	-	586	586	-
			URFL 30 72 58	□	338	-	-	-	761	-	761	761	-
 <p><b>Base shelf unit 15 - 60 cm</b> Shelves angled at front, 2 fixed shelves wide in cm: 15-60</p>		💡	<i>Important! Please state right and left carcass depth (minimum depth 10 cm)</i>										
			URS 00 72 58	R/L	■	271	-	-	-	907	-	907	907
 <p><b>Base shelf unit angled, 37.2°</b> 25 cm wide 2 adjustable shelves 1 plinth panel, separate For adjacent fitting left or right</p>		R/L	URS 25 72 58	■	236	-	-	-	634	-	634	634	-
			💡 <i>Important! Only available in 25 cm width, worktop length 27.5 cm</i>										
 <p><b>Base shelf end unit</b> 25 x 57.7 cm 2 fixed shelves 1 plinth panel, separate For adjacent fitting left or right</p>		R/L	URA 25 72 58	■	207	-	-	-	473	-	473	473	-
			💡 <i>Important! Only available in 25 cm width. Worktop length 29.5 cm</i>										
 <p><b>Base shelf end unit</b> 34 x 57.7 cm 2 fixed shelves 1 plinth panel, separate For adjacent fitting left or right</p>		R/L	URA 34 72 58	■	207	-	-	-	557	-	557	557	-
			💡 <i>Important! Worktop length 36.3 cm</i>										
 <p><b>Base shelf unit for containers</b> Prepared for 4 containers Back panel set forward to 43.1 cm depth</p>		□	URSK 15 72 58	□	218	-	-	-	586	-	586	586	-
<b>M 10</b>	<b>M 20</b>	<b>M 30</b>	<b>M 40</b>	<b>M 50</b>									
K M10 laminate				B M50 Velvet lacquer S M50 microstructure lacquer									
<b>M 60</b>	<b>M 70</b>	<b>M 80</b>	<b>M 90</b>										
	F M70 veneer / oak / walnut Z M70 Veneer / Bavaria	H M80 high gloss-Lacquer MP M80 laqué mat Premium											
 <p><b>Container</b> 11 cm high, for 15 cm wide base shelf unit</p>			SKU 15 13		-	-	-	-	161	-	161	-	-
<b>M 10</b>	<b>M 20</b>	<b>M 30</b>	<b>M 40</b>	<b>M 50</b>									
				B M50 Velvet Lacquer S M50 Microstructure Lacquer									
<b>M 60</b>	<b>M 70</b>	<b>M 80</b>	<b>M 90</b>										
	F M70 veneer / oak / walnut												

# Base shelf units 71.5 cm high

Carcase depth 57.7 cm, flush with front

■ = = Models also available in 36.1/47.7/63.2 cm carcass depth  
(Order no.: replace ... 58 ... with 36/48/63)

Order no.  
W H D

Hinge side:	Carcass depth	Price groups												
		1	2	3	4	5	6	7	8	9				
PTO	36.1 47.7 57.7 63.2		<b>Base shelf unit 45 cm</b> 3 pull-outs with inset front	URIF 45 72 58 IA3K	■	745	759	799	887	995	1087	1125	1238	-
				URIF 45 72 58 IA3B	■	1250	1264	1303	1392	1500	1592	1628	1791	-
				URIF 45 72 58 IA3F	■	1250	1264	1303	1392	1500	1592	1628	1791	-
				URIF 45 72 58 IA3S	■	1250	1264	1303	1392	1500	1592	1628	1791	-
				URIF 45 72 58 IA3Z	■	1250	1264	1303	1392	1500	1592	1628	1791	-
PTO	36.1 47.7 57.7 63.2		<b>Base shelf unit 60 cm</b> 3 pull-outs with inset front	URIF 60 72 58 IA3K	■	782	806	850	941	1073	1141	1196	1316	-
				URIF 60 72 58 IA3B	■	1287	1311	1355	1445	1577	1645	1699	1869	-
				URIF 60 72 58 IA3F	■	1287	1311	1355	1445	1577	1645	1699	1869	-
				URIF 60 72 58 IA3S	■	1287	1311	1355	1445	1577	1645	1699	1869	-
				URIF 60 72 58 IA3Z	■	1287	1311	1355	1445	1577	1645	1699	1869	-
PTO	36.1 47.7 57.7 63.2		<b>Base shelf unit 90 cm</b> 3 pull-outs with inset front	URIF 90 72 58 IA3K	■	971	1065	1075	1178	1340	1452	1508	1659	-
				URIF 90 72 58 IA3B	■	1564	1659	1668	1769	1931	2044	2102	2312	-
				URIF 90 72 58 IA3F	■	1564	1659	1668	1769	1931	2044	2102	2312	-
				URIF 90 72 58 IA3S	■	1564	1659	1668	1769	1931	2044	2102	2312	-
				URIF 90 72 58 IA3Z	■	1564	1659	1668	1769	1931	2044	2102	2312	-
PTO	36.1 47.7 57.7 63.2		<b>Base shelf unit 45 cm</b> 4 drawers with inset front	URIF 45 72 58 IS4K	■	736	740	749	853	971	993	1029	1132	-
				URIF 45 72 58 IS4B	■	1241	1246	1254	1358	1476	1498	1534	1687	-
				URIF 45 72 58 IS4F	■	1241	1246	1254	1358	1476	1498	1534	1687	-
				URIF 45 72 58 IS4S	■	1241	1246	1254	1358	1476	1498	1534	1687	-
				URIF 45 72 58 IS4Z	■	1241	1246	1254	1358	1476	1498	1534	1687	-
PTO	36.1 47.7 57.7 63.2		<b>Base shelf unit 60 cm</b> 4 drawers with inset front	URIF 60 72 58 IS4K	■	763	767	785	899	1020	1079	1129	1242	-
				URIF 60 72 58 IS4B	■	1268	1272	1290	1403	1525	1583	1633	1796	-
				URIF 60 72 58 IS4F	■	1268	1272	1290	1403	1525	1583	1633	1796	-
				URIF 60 72 58 IS4S	■	1268	1272	1290	1403	1525	1583	1633	1796	-
				URIF 60 72 58 IS4Z	■	1268	1272	1290	1403	1525	1583	1633	1796	-
PTO	36.1 47.7 57.7 63.2		<b>Base shelf unit 90 cm</b> 4 drawers with inset front	URIF 90 72 58 IS4K	■	898	920	933	1073	1204	1286	1344	1478	-
				URIF 90 72 58 IS4B	■	1489	1512	1526	1666	1797	1878	1937	2131	-
				URIF 90 72 58 IS4F	■	1489	1512	1526	1666	1797	1878	1937	2131	-
				URIF 90 72 58 IS4S	■	1489	1512	1526	1666	1797	1878	1937	2131	-
				URIF 90 72 58 IS4Z	■	1489	1512	1526	1666	1797	1878	1937	2131	-
				<b>Not available for:</b> ALU TEC RP, ALUELEMENTS, ATLANTA-B, ATLANTA-S, BERGEN, CASTELLO, CHALET-B, CHALET-S, CHICAGO, FRAME, GENT, INTARSIA, LUGANO, LUX-B, MIAMI, NOBEL-B, NOBEL-S, OPAL-H, ORLANDO-B, ORLANDO-S, OSLO 15, PALERMO-B, PALERMO-S, ROMA-B, ROMA-S, SOFIE-B, SOFIE-S, STRIP ELEMENTS, TALEA, TESSIN 15, TIM 15, VILLAGE 15-B, VILLAGE 15-S, VINO, VIVA, YORK-B, YORK-S										

M 10	M 20	M 30	M 40	M 50
K M10 laminate				B M50 Velvet Lacquer S M50 Microstructure Lacquer
M 60	M 70	M 80	M 90	
	F M70 veneer / oak / walnut Z M70 Veneer / Bavaria			

# Base shelf units 71.5 cm high, country house elements

fixed shelves 25 mm with profile at top and bottom  
Carcase depth 57.7 cm, flush with front

▲ = Types also available with 63.2 cm carcase depth (order no. ... replace ... 58 ... with 63)

Order no.  
W H D

Hinge side:	Carcase depth	Decor groups										
		M10	M20	M30	M40	M50	M60	M70	M80	M90		
▲	57.7	<b>Important!</b> Usable inside depth 33.4 cm!										
		URL 30 72 58	-	-	-	-	661	-	-	-	-	
		URL 45 72 58	-	-	-	-	782	-	-	-	-	
		URL 60 72 58	-	-	-	-	902	-	-	-	-	
▲	57.7	URL 90 72 58	-	-	-	-	1141	-	-	-	-	
▲	57.7	<b>Important!</b> Usable inside depth 33.4 cm!										
		URFLL30 72 58	-	-	-	-	985	-	-	-	-	
		URFLL45 72 58	-	-	-	-	1270	-	-	-	-	
		URFLL60 72 58	-	-	-	-	1595	-	-	-	-	
R/L	▲	57.7	URAL 40 72 58	-	-	-	-	976	-	-	-	
				URAL 94 72 35	-	-	-	-	1159	-	-	-
				URAL 11 72 35	-	-	-	-	1212	-	-	-
				URAL 12 72 35	-	-	-	-	1260	-	-	-

M 10	M 20	M 30	M 40	M 50
				B M50 Velvet Lacquer S Microstructur lacquer
M 60	M 70	M 80	M 90	

# Base units 71.5 cm high

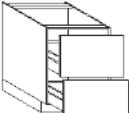
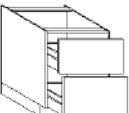
Carcase depth 70.5 cm

		Order no.		Hinge side:	Carcase depth	Price groups											
		W	H			D	1	2	3	4	5	6	7	8	9		
711		<b>Base unit</b> 1 door 71.1 cm 2 adjustable shelves	U	30	72	70	70	R/L	259	270	298	342	361	371	401	441	-
			U	40	72	70	70	R/L	259	270	298	349	361	378	407	448	-
			U	45	72	70	70	R/L	259	270	298	349	361	378	407	448	-
			U	50	72	70	70	R/L	259	270	298	349	378	408	443	487	-
			U	60	72	70	70	R/L	298	310	320	381	427	451	490	539	-
711		<b>Base unit</b> 2 doors 71.1 cm 2 adjustable shelves	U	80	72	70	70		314	328	354	477	565	599	664	730	-
			U	90	72	70	70		314	328	354	477	565	599	665	732	-
			U	100	72	70	70		328	346	376	495	565	599	667	734	-
			U	120	72	70	70		375	401	443	589	663	711	789	868	-
126 581		<b>Base unit</b> 1 drawer 12.6 cm 1 door 58.1 cm 1 adjustable shelf	U	30	72	70	10	R/L	328	338	365	414	435	447	482	530	-
			U	40	72	70	10	R/L	328	338	365	416	435	449	484	532	-
			U	45	72	70	10	R/L	328	338	365	416	444	465	494	543	-
			U	50	72	70	10	R/L	328	338	365	416	444	471	500	550	-
			U	60	72	70	10	R/L	359	370	399	453	484	513	552	607	-
126 581		<b>Base unit</b> 1 drawer 12.6 cm with full-width panel 2 doors 58.1 cm 1 adjustable shelf Left door with buffer strip Without centre panel	U	80	72	70	10		416	423	451	581	637	669	737	811	-
			U	90	72	70	10		416	423	451	581	637	669	737	811	-
			U	100	72	70	10		422	435	464	597	650	686	754	829	-
			U	120	72	70	10		432	445	480	610	663	699	772	849	-
						Width 80, 100 Not available for: GENT, OSLO 15, TESSIN 15, TIM 15, VILLAGE 15-B, VILLAGE 15-S Width 90, 120 Not available for: INTARSIA											
126 256 321		<b>Base unit</b> 1 drawer 12.6 cm 1 pull-out 25.6 cm 1 pull-out 32.1 cm	U	30	72	70	12		641	648	699	740	740	764	810	891	-
			U	40	72	70	12		641	648	699	740	740	764	810	891	-
			U	45	72	70	12		641	648	699	740	740	764	810	891	-
			U	50	72	70	12		641	648	699	740	740	764	810	891	-
			U	60	72	70	12		674	681	724	787	787	814	866	953	-
			U	80	72	70	12		934	953	1029	1107	1126	1172	1266	1393	-
			U	70	72	70	12		934	953	1029	1107	1126	1172	1266	1393	-
			U	90	72	70	12		934	953	1029	1107	1126	1172	1266	1393	-
			U	100	72	70	12		964	979	1065	1144	1161	1214	1313	1444	-
			U	120	72	70	12		986	1012	1098	1183	1201	1255	1358	1494	-
126 321 256		<b>Base unit</b> 1 drawer 12.6 cm 1 pull-out 32.1 cm 1 pull-out 25.6 cm	U	30	72	70	120		641	648	699	740	740	764	810	891	-
			U	40	72	70	120		641	648	699	740	740	764	810	891	-
			U	45	72	70	120		641	648	699	740	740	764	810	891	-
			U	50	72	70	120		641	648	699	740	740	764	810	891	-
			U	60	72	70	120		674	681	724	787	787	814	866	953	-
			U	80	72	70	120		934	953	1029	1107	1126	1172	1266	1393	-
			U	70	72	70	120		934	953	1029	1107	1126	1172	1266	1393	-
			U	90	72	70	120		934	953	1029	1107	1126	1172	1266	1393	-
			U	100	72	70	120		964	979	1065	1144	1161	1214	1313	1444	-
			U	120	72	70	120		986	1012	1098	1183	1201	1255	1358	1494	-
711		<b>Base unit</b> 1 pull-out with front panel 71.1 cm 1 internal pull-out	<del>PTO</del> U	30	72	70	012		649	658	710	752	752	776	824	906	-
			<del>PTO</del> U	40	72	70	012		649	658	710	752	752	776	824	906	-
			<del>PTO</del> U	45	72	70	012		649	658	710	752	752	776	824	906	-
			<del>PTO</del> U	50	72	70	012		649	658	710	752	752	776	824	906	-
			<del>PTO</del> U	60	72	70	012		682	691	737	801	801	828	883	971	-
			Not available with TIP-ON														
126 126 126 321		<b>Base unit</b> 3 drawers 12.6 cm 1 pull-out 32.1 cm	U	30	72	70	31		701	712	728	793	807	830	866	953	-
			U	40	72	70	31		701	712	728	793	807	830	866	953	-
			U	45	72	70	31		701	712	728	793	807	830	866	953	-
			U	50	72	70	31		701	712	728	793	807	830	866	953	-
			U	60	72	70	31		717	724	745	818	838	864	904	994	-
			U	80	72	70	31		950	968	1046	1125	1138	1186	1280	1408	-
			U	70	72	70	31		950	968	1046	1125	1138	1186	1280	1408	-
			U	90	72	70	31		950	968	1046	1125	1138	1186	1280	1408	-
			U	100	72	70	31		982	1009	1092	1173	1188	1242	1341	1475	-
			U	120	72	70	31		1018	1047	1138	1224	1239	1296	1403	1543	-



## Base units 71.5 cm high

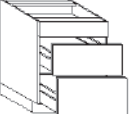
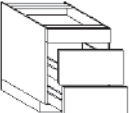
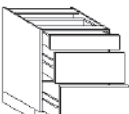
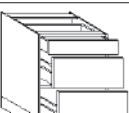
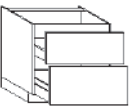
Carcase depth 70.5 cm


	Order no.	W	H	D	Hinge side:	Carcase depth	Price groups								
							1	2	3	4	5	6	7	8	9
386 321  <b>Base unit</b> 1 pull-out 38.6 cm 1 pull-out 32.1 cm	U	30	72	70	02		596	603	651	697	697	718	767	844	-
	U	40	72	70	02		596	603	651	697	697	718	767	844	-
	U	45	72	70	02		596	603	651	697	697	718	767	844	-
	U	50	72	70	02		596	603	651	697	697	718	767	844	-
	U	60	72	70	02		626	637	681	742	742	772	824	906	-
	U	80	72	70	02		893	907	983	1065	1079	1130	1222	1344	-
	U	70	72	70	02		893	907	983	1065	1079	1130	1222	1344	-
	U	90	72	70	02		893	907	983	1065	1079	1130	1222	1344	-
	U	100	72	70	02		908	926	1011	1088	1105	1154	1252	1377	-
	U	120	72	70	02		925	947	1032	1113	1130	1183	1282	1410	-
321 386  <b>Base unit</b> 1 pull-out 32.1 cm 1 pull-out 38.6 cm	U	30	72	70	020		596	603	651	697	697	718	767	844	-
	U	40	72	70	020		596	603	651	697	697	718	767	844	-
	U	45	72	70	020		596	603	651	697	697	718	767	844	-
	U	50	72	70	020		596	603	651	697	697	718	767	844	-
	U	60	72	70	020		626	637	681	742	742	772	824	906	-
	U	80	72	70	020		893	907	983	1065	1079	1130	1222	1344	-
	U	70	72	70	020		893	907	983	1065	1079	1130	1222	1344	-
	U	90	72	70	020		893	907	983	1065	1079	1130	1222	1344	-
	U	100	72	70	020		908	926	1011	1088	1105	1154	1252	1377	-
	U	120	72	70	020		925	947	1032	1113	1130	1183	1282	1410	-

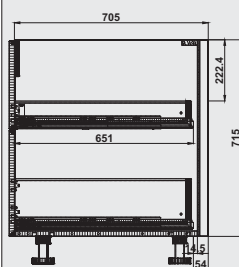
## Hob base units 71.5 cm high

Carcase depth 70.5 cm

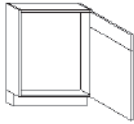
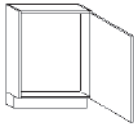
Please follow the fitting instructions from the appliance manufacturers.

126 256 321  <b>Hob base unit</b> 1 panel 12.6 cm 1 cable protective shelf 1 pull-out 25.6 cm 1 pull-out 32.1 cm	UK	60	72	70	82		569	577	624	699	699	727	779	857	-
	UK	70	72	70	82		826	842	924	946	958	1008	1105	1216	-
	UK	80	72	70	82		826	842	924	946	958	1008	1105	1216	-
	UK	90	72	70	82		826	842	924	946	958	1008	1105	1216	-
	UK	100	72	70	82		851	870	961	983	996	1049	1150	1265	-
	UK	120	72	70	82		879	902	993	1022	1035	1090	1196	1316	-
	126 321 256  <b>Hob base unit</b> 1 panel 12.6 cm 1 cable protective shelf 1 pull-out 32.1 cm 1 pull-out 25.6 cm	UK	60	72	70	820		569	577	624	699	699	727	779	857
UK		70	72	70	820		826	842	924	946	958	1008	1105	1216	-
UK		80	72	70	820		826	842	924	946	958	1008	1105	1216	-
UK		90	72	70	820		826	842	924	946	958	1008	1105	1216	-
UK		100	72	70	820		851	870	961	983	996	1049	1150	1265	-
UK		120	72	70	820		879	902	993	1022	1035	1090	1196	1316	-
126 256 321  <b>Hob base unit</b> 1 drawer 12.6 cm but drawer carcase depth 55.5 cm only with low frame 1 cable protective shelf 1 pull-out 25.6 cm 1 pull-out 32.1 cm		UKI	60	72	70	12		750	760	805	862	862	890	944	1038
	UKI	70	72	70	12		1013	1028	1107	1180	1199	1248	1340	1474	-
	UKI	80	72	70	12		1013	1028	1107	1180	1199	1248	1340	1474	-
	UKI	90	72	70	12		1013	1028	1107	1180	1199	1248	1340	1474	-
	UKI	100	72	70	12		1038	1057	1141	1219	1236	1289	1388	1527	-
	UKI	120	72	70	12		1064	1088	1177	1256	1276	1331	1433	1576	-
	126 321 256  <b>Hob base unit</b> 1 drawer 12.6 cm but drawer carcase depth 55.5 cm only with low frame 1 cable protective shelf 1 pull-out 32.1 cm 1 pull-out 25.6 cm	UKI	60	72	70	120		750	760	805	862	862	890	944	1038
UKI		70	72	70	120		1013	1028	1107	1180	1199	1248	1340	1474	-
UKI		80	72	70	120		1013	1028	1107	1180	1199	1248	1340	1474	-
UKI		90	72	70	120		1013	1028	1107	1180	1199	1248	1340	1474	-
UKI		100	72	70	120		1038	1057	1141	1219	1236	1289	1388	1527	-
UKI		120	72	70	120		1064	1088	1177	1256	1276	1331	1433	1576	-
321 386  <b>Hob base unit for hob extractor</b> 1 fixed inside panel 1 drawer 32.1 cm 1 pull-out 38.6 cm		UDK	80	72	70	020		900	913	996	1074	1088	1137	1233	1356
	UDK	90	72	70	020		900	913	996	1074	1088	1137	1233	1356	-
	UDK	100	72	70	020		913	938	1017	1100	1114	1166	1264	1390	-
	UDK	120	72	70	020		931	955	1040	1125	1137	1193	1293	1422	-




 **Note:** The pull-outs are adapted to the respective hob extractor type. We will not assume any liability for damage caused by moisture.







## spacefitter frame 71.5 cm high

				Price groups										
		Order no. W H D		Hinge side:	Carcase depth	1	2	3	4	5	6	7	8	9
126 581		<b>Base unit spacefitter frame</b> 1 panel 12.6 cm attached to 1 door 58.1 cm connected Carcase depth 10 cm For recess cladding		UPR 30 72 10 60	R/L	140	145	149	218	234	250	270	297	-
		UPR 40 72 10 60	R/L	140	145	149	218	234	250	270	297	-		
		UPR 45 72 10 60	R/L	140	145	149	218	234	250	270	297	-		
		UPR 50 72 10 60	R/L	140	145	149	218	234	250	270	297	-		
		UPR 60 72 10 60	R/L	162	171	178	248	288	299	326	359	-		
711		<b>Base unit spacefitter frame</b> 1 door 71.1 cm Carcase depth 10 cm For recess cladding		UPR 20 72 10 70	R/L	140	145	149	218	234	250	270	297	-
		UPR 25 72 10 70	R/L	140	145	149	218	234	250	270	297	-		
		UPR 30 72 10 70	R/L	140	145	149	218	234	250	270	297	-		
		UPR 40 72 10 70	R/L	140	145	149	218	234	250	270	297	-		
		UPR 45 72 10 70	R/L	140	145	149	218	234	250	270	297	-		
		UPR 50 72 10 70	R/L	140	145	149	218	234	250	270	297	-		
UPR 60 72 10 70	R/L	162	171	178	248	288	299	326	359	-				

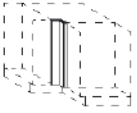

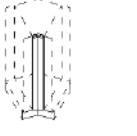
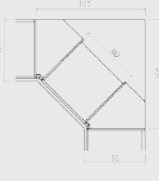

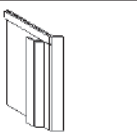
## Background filler 71.5 cm high

				Decor groups										
		Order no. W H D		Hinge side:	Carcase depth	M10	M20	M30	M40	M50	M60	M70	M80	M90
	<b>Base unit background filler</b> Width: 20 cm For fitting flush with carcass	UPSL 00 72				25,70	28,50	38	50	50	50	50	50	-
	<b>Base unit corner background fillers</b> For corner solution 105 x 105 cm, per item	UWSL 72 1				50	50	63	84	84	84	84	84	-
				 <b>Important!</b> 2 x model required for diagonal corner solution.										
<b>M 10</b>	<b>M 20</b>	<b>M 30</b>	<b>M 40</b>	<b>M 50</b>										
K M10 laminate	D M20 Laminate decor	I M30 RESOPAL PRO super matt IH M30 HPL PRO PW M30 PRIMEWOOD/Basic Veneer	A M40 DIRECTLACK matt L M40 DIRECTLACK high-gloss	B M50 Velvet lacquer P M50 Soft lacquer S M50 microstructure lacquer										
<b>M 60</b>	<b>M 70</b>	<b>M 80</b>	<b>M 90</b>											
QH M60 SMARTGLAS high-gloss QM M60 SMARTGLAS satin-finish	F M70 veneer / oak / walnut Z M70 Veneer / Bavaria	C1 M80 FENIX stainless-steel look H M80 high gloss-Lacquer MP M80 laqué mat Premium												

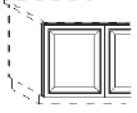
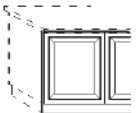
## Front filler 71.5 cm high

				Price groups											
		Order no. W H D		Hinge side:	Carcase depth	1	2	3	4	5	6	7	8	9	
	<b>Base unit front filler</b> 3.5 - 10 cm 10.1 - 20 cm	UP 10 72				50	50	53	71	71	71	75	83	-	
		UP 20 72				60	60	64	88	88	88	98	108	-	
	<b>Base unit front filler with buffer strip</b> and 1 door 71.1 cm, 10 - 20 cm	UPA 20 72		R/L		87	87	93	141	141	141	159	175	-	
	<b>Base unit front filler with grip ledge N700/775</b> minimum size 7.5 cm  7.5 - 10 cm  10.1 - 20 cm	UPN 10 72				50	50	53	71	71	71	75	83	-	
		Extra charge for N...				31	31	31	31	31	31	31	31	31	-
		UPN 20 72				60	60	64	88	88	88	98	108	-	
		Extra charge for N...				31	31	31	31	31	31	31	31	31	-
	<b>Base unit intermediate filler</b> 3.5 - 20 cm	UPZ 20 72				60	60	64	88	88	88	98	108	-	

# Corner filler 71.5 cm high

		Price groups											
Order no.		Hinge side:	Carcase depth	1	2	3	4	5	6	7	8	9	
W H D													
 <p><b>Base unit corner filler 90°</b> 9.5 x 9.5 cm up to 20 x 20 cm</p>	<p><b>Important!</b> Planning dimensions 65 x 65 cm Items in ALU TEC RP models only available with a fixed corner angle min. dimensions 6 x 6 cm!</p>			<b>UPW 65 72</b>	89	89	105	118	118	118	131	144	-
				<b>UPW 75 72</b>	98	98	110	123	123	123	159	175	-
 <p><b>Base unit corner filler 90° with grip ledge N700/775</b> 9.5 x 9.5 cm up to 20 x 20 cm</p>	<p><b>Important!</b> Planning dimensions 65 x 65 cm <b>Not available for:</b> ALU TEC RP</p>			<b>UPWN 65 72</b>	89	89	105	118	118	118	131	144	-
				<b>UPWN 75 72</b>	98	98	110	123	123	123	159	175	-
 <p><b>Base unit corner filler 135°</b> For corner solution 105 x 105 cm</p>	<p><b>Not available for:</b> ALU TEC RP, MIAMI, VIVA</p> <p><b>Important!</b> Planning dimensions 25.9 x 25.9 cm</p> 			<b>UPW 135 72</b>	88	88	103	117	117	117	128	141	-
 <p><b>Base unit corner filler for variable corner solutions / diagonal solutions</b> min. planning dimension 25.9 cm max. planning dimension 38 cm</p>	<p><b>Not available for:</b> ALU TEC RP, MIAMI, VIVA</p> <p><b>Important!</b> 2 x model required for diagonal corner solution. <b>Note:</b> Please specify the precise angle and angle leg. With angles less than 90°, please do not plan pull-outs/drawers or dishwashers in the corner.</p>			<b>UPW 00 72</b>	98	98	110	123	123	123	159	175	-
 <p><b>Base unit corner filler 90° for height offset</b> 9.5 x 9.5 cm with connection height 65 cm</p>	<p><b>Not available for:</b> ALU TEC RP</p> <p><b>Important!</b> Planning dimensions 65 x 65 cm</p>	R/L		<b>UPH 65 72 65</b>	120	120	131	143	143	143	159	175	-

## Back cladding 71.5 cm high with screw-fitted fronts

<p>711</p>  <p><b>Back cladding</b> for base units, 71.5 cm high only available in grid sizes</p> <p>carcase material with screw-fitted fronts 71.1 cm</p>	<p><b>Important!</b> Observe worktop excess depth 66 cm! The plinth panel required is supplied loose.</p>			per 10 cm Width									
				<b>UVF 72</b>	38	41	45	64	66	69	75	83	-
<p>711</p>  <p><b>Back cladding</b> for base units, 71.5 cm high only available in grid sizes</p> <p>carcase material extends down to floor level with screw-fitted fronts 71.1 cm</p>	<p><b>Important!</b> Observe worktop excess depth 66 cm! The plinth panel required is supplied loose.</p>			per 10 cm Width									
				<b>UVF 00 72</b>	38	41	45	64	66	69	75	83	-

## Support panel 71.5 cm high

		Decor groups													
		Order no.	W H D		Hinge side:	Carcass depth	M10	M20	M30	M40	M50	M60	M70	M80	M90
	<b>Base unit support panel</b> 60 cm deep, 98 cm high without plinth cutout Height to be adapted on site	<b>USW 98 60</b>					46	147	284	378	378	378	378	378	-
	<b>Base unit support panel</b> 90 cm deep, 98 cm high without plinth cutout Height to be adapted on site	<b>USW 98 90</b>					48	173	317	422	422	422	422	422	-
<b>M 10</b>	<b>M 20</b>	<b>M 30</b>	<b>M 40</b>		<b>M 50</b>										
K M10 laminate	D M20 Laminate decor	I M30 RESOPAL PRO super matt IH M30 HPL PRO PW M30 PRIMEWOOD/Basic Veneeer	A M40 DIRECTLACK matt L M40 DIRECTLACK high-gloss		B M50 Velvet lacquer S M50 microstructure lacquer										
<b>M 60</b>	<b>M 70</b>	<b>M 80</b>	<b>M 90</b>												
QH M60 SMARTGLAS high-gloss QM M60 SMARTGLAS satin-finish	F M70 veneer / oak / walnut Z M70 Veneer / Bavaria	C1 M80 FENIX stainless-steel look H M80 high gloss-Lacquer MP M80 laqué mat Premium													

## Back cladding 71.5 cm high

	<b>Back cladding</b> With suspension fittings for base units, 71.5 cm high 16 mm thick	per 10 cm Width													
		<b>UVK 72</b>					9,10	15,50	32	44	44	44	44	44	-
		<b>Important!</b> Observe worktop excess depth 64 cm! The plinth panel required is supplied loose.													
	<b>Back cladding</b> With suspension fittings For base units 16 mm thick variable height	per m <sup>2</sup> , W x H													
		<b>UVK 00</b> <b>minimum price</b>						118	200	483	644	644	644	644	644
		<b>Important!</b> Observe worktop excess depth 64 cm! The plinth panel required is supplied loose.													
<b>M 10</b>	<b>M 20</b>	<b>M 30</b>	<b>M 40</b>		<b>M 50</b>										
K M10 laminate	D M20 Laminate decor	I M30 RESOPAL PRO super matt IH M30 HPL PRO PW M30 PRIMEWOOD/Basic Veneeer	A M40 DIRECTLACK matt L M40 DIRECTLACK high-gloss		B M50 Velvet lacquer S M50 microstructure lacquer										
<b>M 60</b>	<b>M 70</b>	<b>M 80</b>	<b>M 90</b>												
QH M60 SMARTGLAS high-gloss QM M60 SMARTGLAS satin-finish	F M70 veneer / oak / walnut Z M70 Veneer / Bavaria	C1 M80 FENIX stainless-steel look H M80 high gloss-Lacquer MP M80 laqué mat Premium													

## Visible sides / increased side depth 71.5 cm high

	<b>Base unit visible side</b>  55.5 cm side depth Fixed dimension, not variable 57.5 cm side depth Fixed dimension, not variable 60.5 cm side depth Fixed dimension, not variable 61 cm side depth Fixed dimension, not variable 70.5 cm side depth Fixed dimension, not variable	<b>Important!</b> Installation instead of a normal unit side. <b>Only available in the listed side depths.</b> For other dimensions, use USVT...														
		<b>USV 72</b>	R/L													
		<b>USV 72 5</b>	R/L													
		<b>USV 72 6</b>	R/L													
		<b>USV 72 6 1</b>	R/L													
		<b>USV 72 7</b>	R/L													
	<b>Base unit increased side depth</b>  from 61.1 cm up to 90 cm side depth Up to 60.9 cm side depth	<b>Important!</b> Installation instead of a normal unit side.														
		<b>USVT 72</b>	R/L													
		<b>USVT 72 6</b>	R/L													
<b>M 10</b>	<b>M 20</b>	<b>M 30</b>	<b>M 40</b>		<b>M 50</b>											
K M10 laminate	D M20 Laminate decor	I M30 RESOPAL PRO super matt IH M30 HPL PRO PW M30 PRIMEWOOD/Basic Veneeer	A M40 DIRECTLACK matt L M40 DIRECTLACK high-gloss		B M50 Velvet lacquer P M50 Soft lacquer RH M50 Velvet lacquer wood texture RW M50 Velvet lacquer spackle effect S M50 microstructure lacquer											
<b>M 60</b>	<b>M 70</b>	<b>M 80</b>	<b>M 90</b>													
QH M60 SMARTGLAS high-gloss QM M60 SMARTGLAS satin-finish	F M70 veneer / oak / walnut V M70 Velvet lacquer textured Z M70 Veneer / Bavaria	C1 M80 FENIX stainless-steel look H M80 high gloss-Lacquer MP M80 laqué mat Premium O M80 Veneered														



# Base units 78 cm high

# 3.3

Height  
78 cm

Base units 78 cm high	XL 3.3.1-XL 3.3.9
Base units as pass-throughs 78 cm high	XL 3.3.9-XL 3.3.10
Base units with glass door 78 cm high model-specific	XL 3.3.10
Base units with glass door 78 cm high neutral	XL 3.3.10-XL 3.3.11
Additional equipment	XL 3.3.11
Oven housings 78 cm high	XL 3.3.11
Hob base units 78 cm high	XL 3.3.11-XL 3.3.14
Hob base units 78 cm high for hob extractors	XL 3.3.14-XL 3.3.15
Sink carcases 78 cm high	XL 3.3.15-XL 3.3.22
Base units 78 cm high for water purifying, boiling and chilling systems	XL 3.3.22-XL 3.3.23
Corner base units Sink carcases 78 cm high	XL 3.3.23
Diagonal corner base unit Sink carcases 78 cm high	XL 3.3.23
Fronts for electrical appliances	XL 3.3.24-XL 3.3.26
Corner base units 78 cm high variable	XL 3.3.26-XL 3.3.28
Corner base units 78 cm high Le Mans	XL 3.3.28-XL 3.3.29
Corner base units 78 cm high as carousel corner unit	XL 3.3.29-XL 3.3.30
Diagonal corner base unit 78 cm high	XL 3.3.30-XL 3.3.31
Base shelf units 78 cm high	XL 3.3.32
Container	XL 3.3.33
Base shelf units 78 cm high	XL 3.3.33
Base shelf units 78 cm high, country house elements	XL 3.3.34
Base shelf units 78 cm high NATURELOOK	XL 3.3.35
Base shelf units 78 cm high TAKEAWAY	XL 3.3.36
Base units 78 cm high	XL 3.3.37-XL 3.3.38
Hob base units 78 cm high	XL 3.3.38-XL 3.3.40
spacefitter frame 78 cm high	XL 3.3.40
Background filler 78 cm high	XL 3.3.41
Front filler 78 cm high	XL 3.3.41
Corner filler 78 cm high	XL 3.3.41-XL 3.3.42
Back cladding 78 cm high with screw-fitted fronts	XL 3.3.42
Support panel 78 cm high	XL 3.3.42
Back cladding 78 cm high	XL 3.3.43
Visible sides / increased side depth 78 cm high	XL 3.3.43

## Legend:



Available with grip ledge N...



Not available with grip ledge N...



This symbol indicates which models are available



This symbol indicates which models are not available



wall-mounted units



available depths for wall-mounted units



Planning advice



= Merchandise net



Not available with „push-to-open“ fitting



This symbol shows optimised gap widths for open appliance recesses (optiSPACE)



Aperture height specifications



Available carcass depths 34/45.5/55.5/61.0 cm



Available carcass depths 45.5/55.5/61.0 cm



Available carcass depths 55.5/61.0 cm

Height  
78 cm



# The most important base unit models 78 cm high

Page XL 3.3.1	Page XL 3.3.1	Page XL 3.3.1	Page XL 3.3.1	Page XL 3.3.1	Page XL 3.3.1	Page XL 3.3.1	Page XL 3.3.2	Page XL 3.3.2
U..785570 Unit widths: 80/90/100/120	U..785560 Unit widths: 30/40/45/50/60	U..785560 Unit widths: 80/90/100/120	U..785510 Unit widths: 30/40/45/50/60	U..785510 Unit widths: 80/90/100/120	U..785518 Unit widths: 80/90/100/120	U..785512 Unit widths: 30/40/45/50/60 70/80/90/100/120	U..7855120 Unit widths: 30/40/45/50/60 70/80/90/100/120	U..785521 Unit widths: 30/40/45/50/60
Page XL 3.3.2	Page XL 3.3.2	Page XL 3.3.2	Page XL 3.3.2	Page XL 3.3.2	Page XL 3.3.3	Page XL 3.3.3	Page XL 3.3.3	Page XL 3.3.3
U..785522 Unit widths: 30/40/45/50/60 70/80/90/100/120	U..785531 Unit widths: 30/40/45/50/60 70/80/90/100/120	U..785541 Unit widths: 30/40/45/50/60 70/80/90/100/120	U..785550 Unit widths: 30/40/45/50/60 70/80/90/100	U..785503 Unit widths: 30/40/45/50/60 70/80/90/100/120	U..7855031 Unit widths: 30/40/45/50/60 70/80/90/100/120	U..7855032 Unit widths: 30/40/45/50/60 70/80/90/100/120	U..785502 Unit widths: 30/40/45/50/60 70/80/90/100/120	U..7855022 Unit widths: 30/40/45/50/60 70/80/90/100/120
Page XL 3.3.3	Page XL 3.3.3	Page XL 3.3.3	Page XL 3.3.3	Page XL 3.3.4	Page XL 3.3.4	Page XL 3.3.4	Page XL 3.3.4	Page XL 3.3.4
U..785502 Unit widths: 180	U..7855012 Unit widths: 30/40/45/50/60	U..785504 Unit widths: 20	U..78550121 Unit widths: 30/40/45/50/60	U..785561 Unit widths: 30	U..785571 Unit widths: 30	U..785507 Unit widths: 15/20	U..785509 Unit widths: 15/20	U..7855088 Unit widths: 15/20
Page XL 3.3.4	Page XL 3.3.4	Page XL 3.3.4	Page XL 3.3.5	Page XL 3.3.5	Page XL 3.3.5	Page XL 3.3.5	Page XL 3.3.5	Page XL 3.3.5
U..7855088 Unit widths: 20	UVP..785507M Unit widths: 30	UVP..785517M Unit widths: 30	U..785507M Unit widths: 30	U..7855071M Unit widths: 30	U..785515 Unit widths: 30/50	U..7855151 Unit widths: 30/50	U..7855152 Unit widths: 30/50	U..7855752 Unit widths: 30/50
Page XL 3.3.5	Page XL 3.3.5	Page XL 3.3.5	Page XL 3.3.5	Page XL 3.3.6	Page XL 3.3.6	Page XL 3.3.6	Page XL 3.3.6	Page XL 3.3.6
U..785508 Unit widths: 30	U..7855081 Unit widths: 30	U..785506M Unit widths: 30	U..7855061M Unit widths: 30	U..786109 Unit widths: 40	U..785573 Unit widths: 30/40/45/50/60	U..785574 Unit widths: 30/40/45/50/60	U..785577 Unit widths: 30/40/45/50/60	U..785563 Unit widths: 30/40/45/50/60
Page XL 3.3.6	Page XL 3.3.6	Page XL 3.3.6	Page XL 3.3.7	Page XL 3.3.7	Page XL 3.3.8	Page XL 3.3.8	Page XL 3.3.8	Page XL 3.3.8
U..785513 Unit widths: 30/40/45/50/60	U..785514 Unit widths: 30/40/45/50/60	U..7855141 Unit widths: 30/40/45/50/60	U..785505 Unit widths: 30/45/50/60	U..7855051 Unit widths: 30/45/50/60	U..785594 Unit widths: 45	U..785586 Unit widths: 60	U..785595 Unit widths: 60	U..7855961 Unit widths: 60

# The most important base unit models 78 cm high

Page XL 3.3.8	Page XL 3.3.8	Page XL 3.3.9	Page XL 3.3.9	Page XL 3.3.9	Page XL 3.3.9	Page XL 3.3.9	Page XL 3.3.9	Page XL 3.3.9
U..785579 Unit widths: 30/40/45/50/60	U..785570 Unit widths: 25	U..785560 Unit widths: 25	USVTP..785507 Unit widths: 25	UDU..785570 Unit widths: 45/50/60	UDU..785570 Unit widths: 80/90/100/120	UDU..785560 Unit widths: 45/50/60	UDU..785560 Unit widths: 80/90/100/120	UDU..785510 Unit widths: 45/50/60
Page XL 3.3.9	Page XL 3.3.10	Page XL 3.3.10	Page XL 3.3.10	Page XL 3.3.10	Page XL 3.3.11	Page XL 3.3.11	Page XL 3.3.11	Page XL 3.3.11
UDU..785518 Unit widths: 80/90/100/120	UG..7855RA Unit widths: 45/50/60	UG..7855LS Unit widths: 45/50/60	UG..7855LB Unit widths: 45/50/60	UGDA..7855 Unit widths: 45/50/60	UH..785510 Unit widths: 60	UH..785512 Unit widths: 60	UH..785584 Unit widths: 60	UM..785586 Unit widths: 60
Page XL 3.3.11	Page XL 3.3.11	Page XL 3.3.12	Page XL 3.3.12	Page XL 3.3.12	Page XL 3.3.12	Page XL 3.3.12	Page XL 3.3.12	Page XL 3.3.12
UM..785583 Unit widths: 60/90	UK..785580 Unit widths: 60	UK..785580 Unit widths: 90	UK..785580 Unit widths: 100/120	UKI..785510 Unit widths: 60	UKI..785510 Unit widths: 80/90/100/120	UKI..78556 Unit widths: 60	UKI..78556 Unit widths: 80/90/100/120	UKI..785561 Unit widths: 60
Page XL 3.3.12	Page XL 3.3.12	Page XL 3.3.13	Page XL 3.3.13	Page XL 3.3.13	Page XL 3.3.13	Page XL 3.3.13	Page XL 3.3.13	Page XL 3.3.13
UKI..785561 Unit widths: 80/90/100/120	UK..785582 Unit widths: 60/70/80/ 90/100/120	UK..7855820 Unit widths: 60/70/80/ 90/100/120	UKI..785512 Unit widths: 60/80/90/100/120	UKI..785513 Unit widths: 60/80/90/100/120	UKI..78554 Unit widths: 60/80/90/100/120	UKI..785541 Unit widths: 60/80/90/100/120	UKI..7855120 Unit widths: 60/80/90/100/120	UKI..7855122 Unit widths: 60/80/90/100/120
Page XL 3.3.13	Page XL 3.3.13	Page XL 3.3.13	Page XL 3.3.14	Page XL 3.3.14	Page XL 3.3.14	Page XL 3.3.14	Page XL 3.3.14	Page XL 3.3.14
UKI..785540 Unit widths: 60/80/90/100/120	UKI..785542 Unit widths: 60/80/90/100/120	UKI..785522 Unit widths: 60/80/90/100/120	UKI..785523 Unit widths: 60/80/90/100/120	UKI..78555 Unit widths: 60/80/90/100/120	UKI..785551 Unit widths: 60/80/90/100/120	UK..785581 Unit widths: 60/70/80/ 90/100/120	UDK..7855028 Unit widths: 70/80/90/100/120	UDK..785502 Unit widths: 80/90/100/120
Page XL 3.3.15	Page XL 3.3.15	Page XL 3.3.15	Page XL 3.3.15	Page XL 3.3.16	Page XL 3.3.16	Page XL 3.3.16	Page XL 3.3.16	Page XL 3.3.16
UDK..7855022 Unit widths: 80/90/100/120	UDK..785582 Unit widths: 80/90/100/120	UDK..785581 Unit widths: 80/90/100/120	US..7855701 Unit widths: 40/45/50/60	US..7855701 Unit widths: 80/90/100/120	US..7855702 Unit widths: 30/40/45/50/60	US..7855702 Unit widths: 80/90/100/120	US..7855601 Unit widths: 40/45/50/60	US..7855601 Unit widths: 80/90/100/120



# The most important base unit models 78 cm high

Page XL 3.3.30	Page XL 3.3.30	Page XL 3.3.31	Page XL 3.3.31	Page XL 3.3.31	Page XL 3.3.31	Page XL 3.3.32	Page XL 3.3.32	Page XL 3.3.32
								
UED..7860 Unit widths: 90x90/105x105	UED..7870 Unit widths: 90x90/105x105	UED..7862 Unit widths: 90x90/105x105	UED..7872 Unit widths: 90x90/105x105	UED..7863 Unit widths: 90x90/105x105	UED..7873 Unit widths: 90x90/105x105	UR..7858 Unit widths: 30/40/45/50/60	URFL..7858 Unit widths: 15/30	URH..7858 Unit widths: 15/20/25
Page XL 3.3.32	Page XL 3.3.32	Page XL 3.3.32	Page XL 3.3.32	Page XL 3.3.32	Page XL 3.3.33	Page XL 3.3.33	Page XL 3.3.34	Page XL 3.3.34
								
URS..7858 Unit widths: 15-60	URS..7858 Unit widths: 25	URA..7858 Unit widths: 25	URA..7858 Unit widths: 34	URSK..7858 Unit widths: 15	URIF..7858IA3K Unit widths: 45/60/90	URIF..7858IS4K Unit widths: 45/60/90	URL..7858 Unit widths: 30/45/60/90	URFL..7858 Unit widths: 30/45/60
Page XL 3.3.34	Page XL 3.3.34	Page XL 3.3.35	Page XL 3.3.35	Page XL 3.3.35	Page XL 3.3.35	Page XL 3.3.35	Page XL 3.3.36	Page XL 3.3.36
								
URAL..7858 Unit widths: 57,7	URAL..7835 Unit widths: 93,8/105,4/115,4	URC..7858K6 Unit widths: 20	KA-E20 Unit widths: 20	URC..7858 Unit widths: 40	URC..785802 Unit widths: 40	URC..785801 Unit widths: 40	URTA..785803 Unit widths: 45/60	URTAH..785803 Unit widths: 45/60
Page XL 3.3.36	Page XL 3.3.36	Page XL 3.3.36	Page XL 3.3.37	Page XL 3.3.37	Page XL 3.3.37	Page XL 3.3.37	Page XL 3.3.37	Page XL 3.3.37
								
TAB-AZM..55 Unit widths: 45/60	TA.55 Unit widths: 45/60	TAH..55 Unit widths: 45/60	U.787070 Unit widths: 30/40/45/50/60	U.787070 Unit widths: 80/90/100/120	U.787010 Unit widths: 30/40/45/50/60	U.787010 Unit widths: 80/90/100/120	U.787012 Unit widths: 30/40/45/50/60 70/80/90/100/120	U.7870012 Unit widths: 30/40/45/50/60
Page XL 3.3.37	Page XL 3.3.37	Page XL 3.3.37	Page XL 3.3.38	Page XL 3.3.38	Page XL 3.3.38	Page XL 3.3.38	Page XL 3.3.40	Page XL 3.3.40
								
U..787022 Unit widths: 30/40/45/50/60 70/80/90/100/120	U..787031 Unit widths: 30/40/45/50/60 70/80/90/100/120	U..787050 Unit widths: 30/40/45/50/60	U..787041 Unit widths: 30/40/45/50/60 70/80/90/100/120	U..787003 Unit widths: 30/40/45/50/60 80/90/100/120	U..787002 Unit widths: 30/40/45/50/60 80/90/100/120	UK..787082 Unit widths: 60/80/90/100/120	UPR..781060 Unit widths: 30/40/45/50/60	UPR..781070 Unit widths: 20/25/30/40/ 45/50/60
Page XL 3.3.41	Page XL 3.3.41	Page XL 3.3.41	Page XL 3.3.41	Page XL 3.3.41	Page XL 3.3.41	Page XL 3.3.42	Page XL 3.3.42	Page XL 3.3.42
								
UP..78 Unit widths: 3,5-20	UPA..78 Unit widths: 10-20	UPN..78 Unit widths: 7,5-20	UPW..78 Unit widths: 65x65/75x75	UPWN..78 Unit widths: 65x65/75x75	UPW..78 Unit widths: 105x105	UPW..78 Unit widths: 60/80/90/100/120	UPH..7865 Unit widths: 9,5x9,5	UVF.. Unit widths: 20/25/30/40/ 45/50/60

# Base units 78 cm high

Carcase depth 55.5 cm (standard)

■ = Models also available in 34/45.5/61 cm carcass depth (Order no.: ... replace ... 55 ... with 34/45/61)  
 □ = Models also available in 45.5/61 cm carcass depth (order no.: replace ... 55 ... with 45/61)  
 ▲ = Types also available with 61 cm carcass depth (order no.: ... replace ... 55 ... with 61)

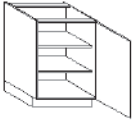

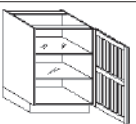


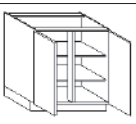
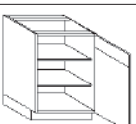
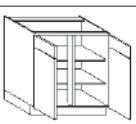
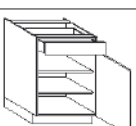
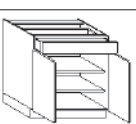

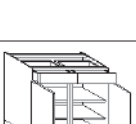
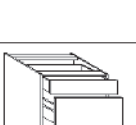
Order no.

W H D

Hinge side:  
Carcass depth

## Price groups

1 2 3 4 5 6 7 8 9

776		<b>Base unit</b> 1 door 77.6 cm 2 adjustable shelves	34,0 45,5 55,5 61,0	U 20 78 55 70	R/L ■	182	191	214	264	284	299	329	362	-
				U 25 78 55 70	R/L ■	182	191	214	264	284	299	329	362	-
				U 30 78 55 70	R/L ■	182	191	214	264	284	299	329	362	-
				U 40 78 55 70	R/L ■	182	191	214	271	284	303	332	365	-
				U 45 78 55 70	R/L ■	182	191	214	271	284	303	332	365	-
				U 50 78 55 70	R/L ■	182	191	214	271	303	325	364	400	-
				U 60 78 55 70	R/L ■	215	227	245	308	354	377	419	461	-
				 width 20 cm: <i>FRAME, VILLAGE 15-S, VILLAGE 15-B, CHALET-S, CHALET-B, OSLO 15, TESSIN 15, BERGEN, LUGANO, CASTELLO, VIVA, TIM 15</i> are supplied with smooth fronts. width 25 cm: <i>FRAME</i> are supplied with smooth fronts.										
776		<b>Base unit</b> 1 door 77.6 cm 2 adjustable glass shelves With „push to open“ fitting	34,0 45,5 55,5 61,0	SE U 60 78 55 70	R/L ■	-	-	-	-	-	-	-	-	1108
				 Available for: STRIP ELEMENTS  Available finishes: 775 Ash black lacquered										
776		<b>Base unit</b> 2 doors 77.6 cm 2 adjustable shelves	34,0 45,5 55,5 61,0	U 80 78 55 70	■	244	253	282	407	490	532	598	658	-
				U 90 78 55 70	■	244	253	282	407	490	532	599	659	-
				U 100 78 55 70	■	255	267	300	430	490	532	601	661	-
				U 120 78 55 70	■	295	312	359	508	581	628	708	779	-
126 646		<b>Base unit</b> 1 panel 12.6 cm attached to 1 front 64.6 cm 2 adjustable shelves	34,0 45,5 55,5 61,0	U 30 78 55 60	R/L ■	182	191	214	264	284	299	329	362	-
				U 40 78 55 60	R/L ■	182	191	214	271	284	303	332	365	-
				U 45 78 55 60	R/L ■	182	191	214	271	284	303	332	365	-
				U 50 78 55 60	R/L ■	182	191	214	271	303	325	364	400	-
				U 60 78 55 60	R/L ■	215	227	245	308	354	377	419	461	-
126 646		<b>Base unit</b> 2 panels 12.6 cm with 2 doors 64.6 cm 2 adjustable shelves	34,0 45,5 55,5 61,0	U 80 78 55 60	■	244	253	282	407	490	532	598	658	-
				U 90 78 55 60	■	244	253	282	407	490	532	599	659	-
				U 100 78 55 60	■	255	267	300	430	490	532	601	661	-
				U 120 78 55 60	■	295	312	359	508	581	628	708	779	-
126 646		<b>Base unit</b> 1 drawer 12.6 cm 1 door 64.6 cm 2 adjustable shelves	34,0 45,5 55,5 61,0	U 30 78 55 10	R/L ■	229	236	262	323	341	363	393	432	-
				U 40 78 55 10	R/L ■	229	236	262	324	341	365	398	438	-
				U 45 78 55 10	R/L ■	229	236	262	324	356	373	408	449	-
				U 50 78 55 10	R/L ■	229	236	262	324	356	375	411	452	-
				U 60 78 55 10	R/L ■	261	271	303	369	402	427	472	519	-
126 646		<b>Base unit</b> 1 drawer 12.6 cm with full-width panel 2 doors 64.6 cm 2 adjustable shelves Left door with buffer strip Without centre panel	34,0 45,5 55,5 61,0	U 80 78 55 10	■	320	329	360	498	555	595	660	726	-
				U 90 78 55 10	■	320	329	360	498	555	595	660	726	-
				U 100 78 55 10	■	328	340	371	513	568	607	677	745	-
				U 120 78 55 10	■	338	351	381	526	580	621	692	761	-
				 Width 80, 100 Not available for: <i>GENT, INTARSIA, OSLO 15, TESSIN 15, TIM 15, VILLAGE 15-B, VILLAGE 15-S</i> Width 90, 120 Not available for: <i>INTARSIA</i>										
126 646		<b>Base unit</b> 2 drawers 12.6 cm 2 doors 64.6 cm 2 adjustable shelves	34,0 45,5 55,5 61,0	U 80 78 55 18	■	351	365	385	527	584	623	692	761	-
				U 90 78 55 18	■	351	365	390	530	584	623	693	762	-
				U 100 78 55 18	■	366	375	407	550	584	623	694	763	-
				U 120 78 55 18	■	408	427	465	631	686	731	813	894	-
126 256 386		<b>Base unit</b> 1 drawer 12.6 cm 1 pull-out 25.6 cm 1 pull-out 38.6 cm	34,0 45,5 55,5 61,0	U 30 78 55 12	■	467	479	526	577	577	601	652	717	-
				U 40 78 55 12	■	467	479	526	577	577	601	652	717	-
				U 45 78 55 12	■	467	479	526	577	577	601	652	717	-
				U 50 78 55 12	■	467	479	526	577	577	601	652	717	-
				U 60 78 55 12	■	500	513	558	626	626	657	713	784	-
				U 70 78 55 12	■	781	794	881	965	981	1032	1133	1246	-
				U 80 78 55 12	■	781	794	881	965	981	1032	1133	1246	-
				U 90 78 55 12	■	783	797	884	970	983	1035	1135	1249	-
				U 100 78 55 12	■	807	826	917	1004	1019	1075	1178	1296	-
				U 120 78 55 12	■	834	854	950	1040	1059	1116	1225	1348	-

# Base units 78 cm high

Carcase depth 55.5 cm (standard)

- = Models also available in 34/45.5/61 cm carcass depth (Order no.: ... replace ... 55 ... with 34/45/61)
- = Models also available in 45.5/61 cm carcass depth (order no.: replace ... 55 ... with 45/61)
- ▲ = Types also available with 61 cm carcass depth (order no. ... replace ... 55 ... with 61)

Order no.  
W H D

Hinge side:	Carcass depth	Price groups												
		1	2	3	4	5	6	7	8	9				
34- 45.5 55.5 61.0	U	30	78	55	120	467	479	526	577	577	601	652	717	-
		40	78	55	120	467	479	526	577	577	601	652	717	-
		45	78	55	120	467	479	526	577	577	601	652	717	-
		50	78	55	120	467	479	526	577	577	601	652	717	-
		60	78	55	120	500	513	558	626	626	657	713	784	-
		70	78	55	120	781	794	881	965	981	1032	1133	1246	-
		80	78	55	120	781	794	881	965	981	1032	1133	1246	-
		90	78	55	120	783	797	884	970	983	1035	1135	1249	-
		100	78	55	120	807	826	917	1004	1019	1075	1178	1296	-
120	78	55	120	834	854	950	1040	1059	1116	1225	1348	-		
34- 45.5 55.5 61.0	U	30	78	55	21	467	479	526	577	577	601	652	717	-
		40	78	55	21	467	479	526	577	577	601	652	717	-
		45	78	55	21	467	479	526	577	577	601	652	717	-
		50	78	55	21	467	479	526	577	577	601	652	717	-
		60	78	55	21	500	513	558	626	626	657	713	784	-
34- 45.5 55.5 61.0	U	30	78	55	22	572	580	630	678	678	702	752	827	-
		40	78	55	22	572	580	630	678	678	702	752	827	-
		45	78	55	22	572	580	630	678	678	702	752	827	-
		50	78	55	22	572	580	630	678	678	702	752	827	-
		60	78	55	22	604	615	658	728	728	758	813	894	-
		70	78	55	22	884	899	981	1067	1080	1134	1231	1354	-
		80	78	55	22	884	899	981	1067	1080	1134	1231	1354	-
		90	78	55	22	884	899	981	1067	1080	1134	1231	1354	-
		100	78	55	22	920	936	1028	1116	1132	1189	1292	1421	-
120	78	55	22	954	976	1074	1168	1180	1247	1355	1491	-		
34- 45.5 55.5 61.0	U	30	78	55	31	467	481	496	570	586	612	652	717	-
		40	78	55	31	467	481	496	570	586	612	652	717	-
		45	78	55	31	467	481	496	570	586	612	652	717	-
		50	78	55	31	467	481	496	570	586	612	652	717	-
		60	78	55	31	484	493	515	599	618	647	689	758	-
		70	78	55	31	846	859	943	1027	1040	1094	1193	1312	-
		80	78	55	31	846	859	943	1027	1040	1094	1193	1312	-
		90	78	55	31	846	859	943	1027	1040	1094	1193	1312	-
		100	78	55	31	879	899	986	1078	1090	1150	1253	1378	-
120	78	55	31	912	939	1032	1130	1142	1206	1315	1447	-		
34- 45.5 55.5 61.0	U	30	78	55	41	572	582	603	674	692	713	752	827	-
		40	78	55	41	572	582	603	674	692	713	752	827	-
		45	78	55	41	572	582	603	674	692	713	752	827	-
		50	78	55	41	572	582	603	674	692	713	752	827	-
		60	78	55	41	586	598	620	701	719	749	790	869	-
		70	78	55	41	932	949	1031	1110	1128	1177	1276	1404	-
		80	78	55	41	932	949	1031	1110	1128	1177	1276	1404	-
		90	78	55	41	932	949	1031	1110	1128	1177	1276	1404	-
		100	78	55	41	976	1001	1090	1174	1189	1248	1350	1485	-
120	78	55	41	1020	1049	1148	1239	1252	1317	1428	1571	-		
34- 45.5 55.5 61.0	U	30	78	55	50	643	652	692	783	783	800	863	949	-
		40	78	55	50	643	652	692	783	783	800	863	949	-
		45	78	55	50	643	652	692	783	783	800	863	949	-
		50	78	55	50	643	652	692	783	783	800	863	949	-
		60	78	55	50	677	687	722	823	823	853	923	1015	-
		70	78	55	50	991	1005	1092	1173	1188	1239	1341	1475	-
		80	78	55	50	991	1005	1092	1173	1188	1239	1341	1475	-
		90	78	55	50	991	1005	1092	1173	1188	1239	1341	1475	-
		100	78	55	50	1044	1070	1165	1251	1267	1324	1434	1577	-
34- 45.5 55.5 61.0	U	30	78	55	03	515	523	570	621	621	644	695	765	-
		40	78	55	03	515	523	570	621	621	644	695	765	-
		45	78	55	03	515	523	570	621	621	644	695	765	-
		50	78	55	03	515	523	570	621	621	644	695	765	-
		60	78	55	03	546	555	599	667	667	700	756	832	-
		70	78	55	03	826	841	925	1011	1025	1077	1176	1294	-
		80	78	55	03	826	841	925	1011	1025	1077	1176	1294	-
		90	78	55	03	826	841	925	1011	1025	1077	1176	1294	-
		100	78	55	03	851	869	962	1047	1063	1117	1222	1344	-
120	78	55	03	879	900	995	1085	1098	1160	1269	1396	-		

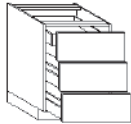
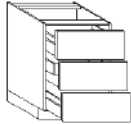
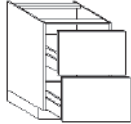
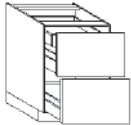
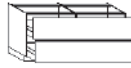
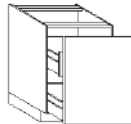
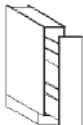
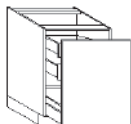


# Base units 78 cm high

Carcase depth 55.5 cm (standard)

- = Models also available in 34/45.5/61 cm carcass depth (Order no.: ... replace ... 55 ... with 34/45/61)
- = Models also available in 45.5/61 cm carcass depth (order no.: replace ... 55 ... with 45/61)
- ▲ = Types also available with 61 cm carcass depth (order no.: ... replace ... 55 ... with 61)

Order no.  
W H D

Hinge side:	Carcass depth	Price groups												
		1	2	3	4	5	6	7	8	9				
256 256 256	34,0 45,5 55,5 61,0		<b>Base unit</b> 1 drawer 25.6 cm 1 internal drawer 2 pull-outs 25.6 cm	U 30 78 55 031	■	585	597	649	692	699	720	766	843	-
				U 40 78 55 031	■	585	597	649	692	699	720	766	843	-
				U 45 78 55 031	■	585	597	649	692	699	720	766	843	-
				U 50 78 55 031	■	585	597	649	692	699	720	766	843	-
				U 60 78 55 031	■	629	642	689	704	710	732	778	856	-
				U 70 78 55 031	■	924	942	1031	1109	1130	1180	1272	1399	-
				U 80 78 55 031	■	924	942	1031	1109	1130	1180	1272	1399	-
				U 90 78 55 031	■	924	942	1031	1109	1130	1180	1272	1399	-
				U 100 78 55 031	■	964	982	1077	1156	1178	1231	1331	1464	-
U 120 78 55 031	■	992	1018	1117	1199	1219	1278	1382	1520	-				
256 256 256	34,0 45,5 55,5 61,0		<b>Base unit</b> 1 pull-out 25.6 cm 1 drawer 25.6 cm 1 internal drawer 1 pull-out 25.6 cm	U 30 78 55 032	■	585	597	649	692	699	720	766	843	-
				U 40 78 55 032	■	585	597	649	692	699	720	766	843	-
				U 45 78 55 032	■	585	597	649	692	699	720	766	843	-
				U 50 78 55 032	■	585	597	649	692	699	720	766	843	-
				U 60 78 55 032	■	629	642	689	704	710	732	778	856	-
				U 70 78 55 032	■	924	942	1031	1109	1130	1180	1272	1399	-
				U 80 78 55 032	■	924	942	1031	1109	1130	1180	1272	1399	-
				U 90 78 55 032	■	924	942	1031	1109	1130	1180	1272	1399	-
				U 100 78 55 032	■	964	982	1077	1156	1178	1231	1331	1464	-
U 120 78 55 032	■	992	1018	1117	1199	1219	1278	1382	1520	-				
386 386	34,0 45,5 55,5 61,0		<b>Base unit</b> 2 pull-outs 38.6 cm	U 30 78 55 02	■	436	444	492	546	546	568	620	682	-
				U 40 78 55 02	■	436	444	492	546	546	568	620	682	-
				U 45 78 55 02	■	436	444	492	546	546	568	620	682	-
				U 50 78 55 02	■	436	444	492	546	546	568	620	682	-
				U 60 78 55 02	■	467	480	524	596	596	623	681	749	-
				U 70 78 55 02	■	747	764	850	935	950	1003	1101	1211	-
				U 80 78 55 02	■	747	764	850	935	950	1003	1101	1211	-
				U 90 78 55 02	■	747	764	850	935	950	1003	1101	1211	-
				U 100 78 55 02	■	767	783	871	961	976	1029	1133	1246	-
U 120 78 55 02	■	783	803	895	986	1003	1061	1163	1279	-				
386 386	34,0 45,5 55,5 61,0		<b>Base unit</b> 1 pull-out 38.6 cm 1 internal drawer 1 pull-out 38.6 cm	U 30 78 55 022	■	541	549	597	649	649	669	721	793	-
				U 40 78 55 022	■	548	555	603	654	654	677	728	801	-
				U 45 78 55 022	■	549	557	604	655	655	678	730	803	-
				U 50 78 55 022	■	550	558	607	656	656	681	731	804	-
				U 60 78 55 022	■	597	608	652	720	720	749	805	886	-
				U 70 78 55 022	■	880	894	978	1064	1077	1128	1226	1349	-
				U 80 78 55 022	■	880	894	978	1064	1077	1128	1226	1349	-
				U 90 78 55 022	■	884	897	982	1067	1080	1132	1230	1353	-
				U 100 78 55 022	■	907	924	1014	1098	1113	1169	1270	1397	-
U 120 78 55 022	■	931	949	1041	1126	1140	1197	1296	1426	-				
386 386	34,0 45,5 55,5 61,0		<b>Base unit</b> consisting of: 2 x 90 cm wide carcasses each with 2 pull-outs Overall carcass width 180 cm 2 full-width panels 38.6 cm high and 179.6 cm wide	U 180 78 55 02	■	1573	1603	1786	1965	1997	2104	2314	2545	-
<p><b>Not available for:</b>                      ALU TEC RP, ALUELEMENTS, ATLANTA-B, ATLANTA-S, BERGEN, CASTELLO, CHALET-B, CHALET-S, CHICAGO, FENIX INOX, FRAME, HPL PRO, INTARSIA, LUGANO, LUX-B, MIAMI, MONTANA, MPX, NEVADA, NOBEL-B, NOBEL-S, ORLANDO-B, ORLANDO-S, PUR, RESOPAL PRO, RESOPAL PRO EDGE, RUSTY OAK, SMART-M, SOFIE-B, SOFIE-S, STRIP ELEMENTS, TALEA, TESSIN 15, TIM, TIM 15, VINO, VIVA, YORK-B, YORK-S</p> <p><b>Available handles:</b> from a drilling distance of 128 mm                      Not available with TIP-ON Blumotion</p>														
776	34,0 45,5 55,5 61,0		<b>Base unit</b> 1 pull-out with front panel 77.6 cm 1 internal pull-out	U 30 78 55 012	□	467	479	526	577	577	601	652	717	-
				U 40 78 55 012	□	467	479	526	577	577	601	652	717	-
				U 45 78 55 012	□	467	479	526	577	577	601	652	717	-
				U 50 78 55 012	□	467	479	526	577	577	601	652	717	-
				U 60 78 55 012	□	500	513	558	626	626	657	713	784	-
<p><b>Not available with TIP-ON Blumotion</b></p>														
776	34,0 45,5 55,5 61,0		<b>Base unit</b> 1 pull-out and 1 drawer with front panel 77.6 cm	U 20 78 55 04	▲	366	373	398	463	484	501	534	587	-
<p><b>Not available with TIP-ON Blumotion</b></p>														
776	34,0 45,5 55,5 61,0		<b>Base unit</b> 1 pull-out with front panel 77.6 cm with 2 internal drawers	U 30 78 55 0121	□	541	549	597	649	649	669	721	793	-
				U 40 78 55 0121	□	548	555	603	654	654	677	728	801	-
				U 45 78 55 0121	□	549	557	604	655	655	678	730	803	-
				U 50 78 55 0121	□	550	558	607	656	656	681	731	804	-
				U 60 78 55 0121	□	597	608	652	720	720	749	805	886	-
<p><b>Not available with TIP-ON Blumotion</b></p>														



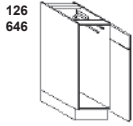
# Base units 78 cm high

Carcase depth 55.5 cm (standard)

■ = Models also available in 34/45.5/61 cm carcass depth (Order no.: ... replace ... 55 ... with 34/45/61)  
 □ = Models also available in 45.5/61 cm carcass depth (order no.: replace ... 55 ... with 45/61)  
 ▲ = Types also available with 61 cm carcass depth (order no. ... replace ... 55 ... with 61)

Order no.  
W H D

Hinge side:	Carcass depth	Price groups								
		1	2	3	4	5	6	7	8	9
R/L ▲	▲	205	215	236	299	304	322	357	393	-
R/L ▲	▲	205	215	236	299	304	322	357	393	-
▲	▲	300	307	332	398	419	436	469	516	-
			15							
▲	▲	315	322	349	411	436	447	481	529	-
▲	▲	300	307	332	398	419	436	469	516	-
▲	▲	315	322	349	411	436	447	481	529	-
▲	▲	339	347	371	437	458	474	508	559	-
▲	▲	339	347	371	437	458	474	508	559	-
▲	▲	621	631	653	695	713	728	760	836	-
▲	▲	621	631	653	695	713	728	760	836	-



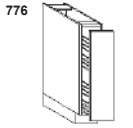
**Base unit**  
 1 panel 12.6 cm attached to  
 1 door 64.6 cm connected  
 1 towel rail, 2-part

U 30 78 55 61



**Base unit**  
 1 door 77.6 cm  
 1 towel rail, 2-part

U 30 78 55 71



**Base unit**  
 1 pull-out 77.6 cm  
 2 fixed-position baskets with metal base  
 and chrome-plated, square-section rail



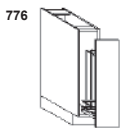
U 15 78 55 07

Not available for:  
MIAMI, VIVA

Note:  
Available frame fronts are supplied with smooth fronts.  
Most handles arranged vertically!

Set of 3 separating bars

TRB15-3



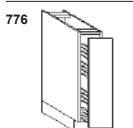
**Base unit**  
 1 pull-out 77.6 cm  
 with 1 towel rail  
 and 1 basket (chrome-plated)



U 15 78 55 09

Not available for:  
MIAMI, VIVA

Note:  
Available frame fronts are supplied with smooth fronts.  
Most handles arranged vertically!



**Base unit**  
 1 pull-out 77.6 cm  
 2 fixed-position baskets with metal base  
 and chrome-plated, square-section rail



U 20 78 55 07

Not available for:  
BERGEN, LUGANO

Note:  
pull-out as for unit in 150 mm width (U 15 78 55 07)

Models:  
FRAME, VILLAGE 15-S, VILLAGE 15-B, OSLO 15, TESSIN 15, BERGEN, LUGANO,  
CASTELLO, VIVA, VINO, TIM 15  
are supplied with smooth fronts.



**Base unit**  
 1 pull-out 77.6 cm  
 with 1 towel rail  
 and 1 basket (chrome-plated)

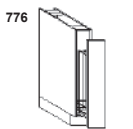


U 20 78 55 09

Not available for:  
BERGEN, LUGANO

Note:  
Pull-out as for unit in 15 cm width (U 15 78 55 09)

Models:  
FRAME, VILLAGE 15-S, VILLAGE 15-B, OSLO 15, TESSIN 15, BERGEN, LUGANO,  
CASTELLO, VIVA, VINO, TIM 15  
are supplied with smooth fronts.



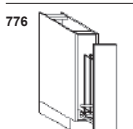
**Base unit**  
 1 pull-out 77.6 cm  
 and 1 basket (chrome-plated)



U 15 78 55 088

Not available for:  
MIAMI, VIVA

Note:  
Available frame fronts are supplied with smooth fronts.  
Most handles arranged vertically!



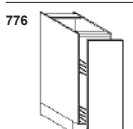
**Base unit**  
 1 pull-out 77.6 cm  
 and 1 basket (chrome-plated)



U 20 78 55 088

Not available for:  
BERGEN, LUGANO

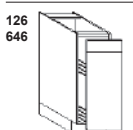
Note:  
Pull-out as for unit in 15 cm width (U 15 78 55 09)  
width 20 cm: FRAME, VILLAGE 15-S, VILLAGE 15-B, CHALET-S, CHALET-B, OSLO 15, TESSIN 15,  
BERGEN, LUGANO, CASTELLO, VIVA, TIM 15  
are supplied with smooth fronts.



**Base unit**  
 1 pull-out 77.6 cm  
 With 2 adjustable wooden shelves  
 with chrome-plated square rail



UVP 30 78 55 07M



**Base unit**  
 1 panel 12.6 cm attached to  
 1 front 64.6 cm  
 With 2 adjustable wooden shelves  
 with chrome-plated square rail



UVP 30 78 55 17M

# Base units 78 cm high

Carcase depth 55.5 cm (standard)

■ = Models also available in 34/45.5/61 cm carcass depth (Order no.: ... replace ... 55 ... with 34/45/61)  
 □ = Models also available in 45.5/61 cm carcass depth (order no.: replace ... 55 ... with 45/61)  
 ▲ = Types also available with 61 cm carcass depth (order no.: ... replace ... 55 ... with 61)

Order no.  
W H D

Hinge side:	Carcass depth	Price groups									
		1	2	3	4	5	6	7	8	9	
▲	55.5	U 30 78 55 07M	495	507	528	573	594	606	639	703	-
		PTO									
▲	55.5	U 30 78 55 071M	495	507	528	573	594	606	639	703	-
		PTO									
▲	55.5	U 30 78 55 15	325	331	363	425	447	469	498	548	-
		U 50 78 55 15	363	370	398	472	485	513	550	605	-
▲	55.5	U 30 78 55 151	431	437	467	532	554	573	604	664	-
		U 50 78 55 151	477	484	509	584	599	626	664	730	-
▲	55.5	U 30 78 55 152	479	484	515	579	602	621	651	716	-
		U 50 78 55 152	530	537	563	639	652	681	718	790	-
▲	55.5	U 30 78 55 752	431	437	467	532	554	573	604	664	-
		U 50 78 55 752	477	484	509	584	599	626	664	730	-
▲	55.5	U 30 78 55 08	626	639	658	702	720	735	765	842	-
<b>Note:</b> May not be planned directly against a wall.											
▲	55.5	U 30 78 55 081	626	639	658	702	720	735	765	842	-
<b>Note:</b> May not be planned directly against a wall.											
▲	55.5	U 30 78 55 06M	566	578	599	643	661	676	707	778	-
▲	55.5	U 30 78 55 061M	566	578	599	643	661	676	707	778	-

= extra charge for wall-mounted units, item: **MP-WST**

# Base units 78 cm high

Carcase depth 55.5 cm (standard)

■ = Models also available in 34/45.5/61 cm carcass depth (Order no.: ... replace ... 55 ... with 34/45/61)  
 □ = Models also available in 45.5/61 cm carcass depth (order no.: replace ... 55 ... with 45/61)  
 ▲ = Types also available with 61 cm carcass depth (order no. ... replace ... 55 ... with 61)

Order no.  
 W H D

Hinge side:	Carcass depth	Price groups									
		1	2	3	4	5	6	7	8	9	
R/L ▲	55.5	U 40 78 55 09	449	461	483	541	553	572	602	662	-
R/L ■	55.5	U 30 78 55 73	445	453	479	550	563	587	625	688	-
		U 40 78 55 73	445	453	479	550	563	587	625	688	-
		U 45 78 55 73	445	453	479	550	563	587	625	688	-
		U 50 78 55 73	445	453	479	550	563	587	625	688	-
		U 60 78 55 73	477	487	515	587	608	637	675	743	-
<p><b>Important!</b>                  Doors with wide angle hinges may not be planned alongside units or panels if the protrusion to the front of the adjoining article is greater than 3 cm (hinge side).                  Doors with wide angle hinges protrude over the carcass side.</p>											
R/L ■	55.5	U 30 78 55 74	437	443	470	541	554	579	617	679	-
		U 40 78 55 74	437	443	470	541	554	579	617	679	-
		U 45 78 55 74	437	443	470	541	554	579	617	679	-
		U 50 78 55 74	437	443	470	541	554	579	617	679	-
		U 60 78 55 74	467	478	507	579	599	628	666	733	-
<p><b>Important!</b>                  Doors with wide angle hinges may not be planned alongside units or panels if the protrusion to the front of the adjoining article is greater than 3 cm (hinge side).                  Doors with wide angle hinges protrude over the carcass side.</p>											
R/L ■	55.5	U 30 78 55 77	543	550	577	648	661	686	723	795	-
		U 40 78 55 77	548	554	581	652	666	690	727	800	-
		U 45 78 55 77	549	555	582	653	667	691	728	801	-
		U 50 78 55 77	551	558	584	655	669	693	731	804	-
		U 60 78 55 77	585	596	624	696	717	745	783	861	-
<p><b>Important!</b>                  Doors with wide angle hinges may not be planned alongside units or panels if the protrusion to the front of the adjoining article is greater than 3 cm (hinge side).                  Doors with wide angle hinges protrude over the carcass side.</p>											
R/L ■	55.5	U 30 78 55 63	445	453	479	550	563	587	625	688	-
		U 40 78 55 63	445	453	479	550	563	587	625	688	-
		U 45 78 55 63	445	453	479	550	563	587	625	688	-
		U 50 78 55 63	445	453	479	550	563	587	625	688	-
		U 60 78 55 63	477	487	515	587	608	637	675	743	-
<p><b>Important!</b>                  Doors with wide angle hinges may not be planned alongside units or panels if the protrusion to the front of the adjoining article is greater than 3 cm (hinge side).                  Doors with wide angle hinges protrude over the carcass side.</p>											
R/L ■	55.5	U 30 78 55 13	492	499	524	597	612	633	671	738	-
		U 40 78 55 13	492	499	524	597	612	633	671	738	-
		U 45 78 55 13	492	499	524	597	612	633	671	738	-
		U 50 78 55 13	492	499	524	597	612	633	671	738	-
		U 60 78 55 13	523	533	562	633	655	684	720	792	-
<p><b>Important!</b>                  Doors with wide angle hinges may not be planned alongside units or panels if the protrusion to the front of the adjoining article is greater than 3 cm (hinge side).                  Doors with wide angle hinges protrude over the carcass side.</p>											
R/L ■	55.5	U 30 78 55 14	422	434	460	532	550	570	606	667	-
		U 40 78 55 14	422	434	460	532	550	570	606	667	-
		U 45 78 55 14	422	434	460	532	550	570	606	667	-
		U 50 78 55 14	422	434	460	532	550	570	606	667	-
		U 60 78 55 14	453	471	496	568	583	615	654	719	-
<p><b>Important!</b>                  Doors with wide angle hinges may not be planned alongside units or panels if the protrusion to the front of the adjoining article is greater than 3 cm (hinge side).                  Doors with wide angle hinges protrude over the carcass side.</p>											
R/L ■	55.5	U 30 78 55 141	471	481	505	578	597	616	652	717	-
		U 40 78 55 141	474	484	508	581	601	620	655	721	-
		U 45 78 55 141	476	485	509	582	602	621	656	722	-
		U 50 78 55 141	477	487	512	583	603	622	657	723	-
		U 60 78 55 141	506	524	550	620	637	666	707	778	-
<p><b>Important!</b>                  Doors with wide angle hinges may not be planned alongside units or panels if the protrusion to the front of the adjoining article is greater than 3 cm (hinge side).                  Doors with wide angle hinges protrude over the carcass side.</p>											

# Base units 78 cm high

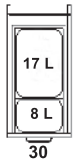
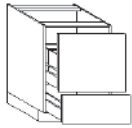
Carcase depth 55.5 cm (standard)

■ = Models also available in 34/45.5/61 cm carcass depth (Order no.: ... replace ... 55 ... with 34/45/61)  
 □ = Models also available in 45.5/61 cm carcass depth (order no.: replace ... 55 ... with 45/61)  
 ▲ = Types also available with 61 cm carcass depth (order no.: ... replace ... 55 ... with 61)

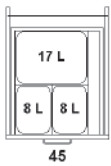
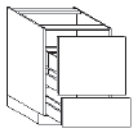
Order no.  
W H D

Hinge side:	Carcass depth	Price groups								
		1	2	3	4	5	6	7	8	9
▲	▲	678	687	737	783	783	807	858	944	-
▲	▲	678	687	737	783	783	807	858	944	-
▲	▲	678	687	737	783	783	807	858	944	-
▲	▲	711	720	769	831	831	862	920	1012	-
▲	▲	678	687	737	783	783	807	858	944	-
▲	▲	678	687	737	783	783	807	858	944	-
▲	▲	678	687	737	783	783	807	858	944	-
▲	▲	711	720	769	831	831	862	920	1012	-

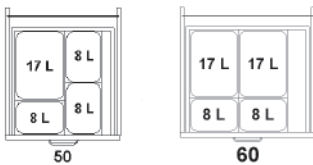
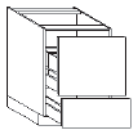
516 256 **Base unit**  
 1 pull-out 51.6 cm  
 with waste bins  
 1 pull-out 25.6 cm



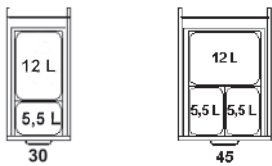
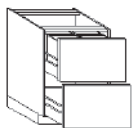
516 256 **Base unit**  
 1 pull-out 51.6 cm  
 with 3 waste bins  
 1 pull-out 25.6 cm



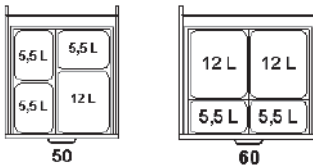
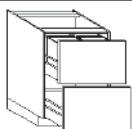
516 256 **Base unit**  
 1 pull-out 51.6 cm  
 with 4 waste bins  
 1 pull-out 25.6 cm



386 386 **Base unit**  
 1 pull-out 38.6 cm  
 with waste bins  
 1 pull-out 38.6 cm



386 386 **Base unit**  
 1 pull-out 38.6 cm  
 with 4 waste bins  
 1 pull-out 38.6 cm



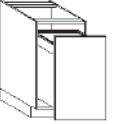


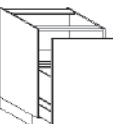
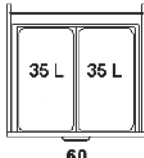

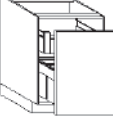


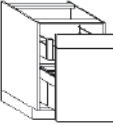
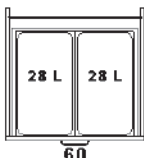

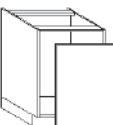
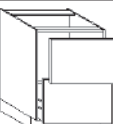

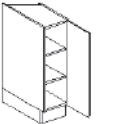

# Base units 78 cm high

Carcase depth 55.5 cm (standard)

■ = Models also available in 34/45.5/61 cm carcse depth (Order no.: ... replace ... 55 ... with 34/45/61)  
 □ = Models also available in 45.5/61 cm carcse depth (order no.: replace ... 55 ... with 45/61)  
 ▲ = Types also available with 61 cm carcse depth (order no. ... replace ... 55 ... with 61)

Order no.  
W H D

## Price groups

	Hinge side:	Carcase depth	Price groups															
			1	2	3	4	5	6	7	8	9							
776   45	PTO	▲	U	45	78	55	94	▲	526	541	558	625	663	685	725	798	-	
			 Not available with TIP-ON															
776   60	PTO	▲	U	60	78	55	86	▲	646	662	705	721	750	762	790	869	-	
			 Not available with TIP-ON															
776   60	PTO	▲	U	60	78	55	95	▲	553	568	585	652	690	712	752	827	-	
			 Not available with TIP-ON															
126 646   60	PTO	▲	U	60	78	55	961	▲	553	568	585	652	690	712	752	827	-	
			 Not available with TIP-ON Blumotion Not available for N7.. finger pulls															
776 	□		U	30	78	55	79	■	224	232	255	305	325	340	370	407	-	
			U	40	78	55	79	■	224	232	255	312	325	345	373	410	-	
			U	45	78	55	79	■	224	232	255	312	325	345	373	410	-	
			U	50	78	55	79	■	224	232	255	312	345	367	404	444	-	
			U	60	78	55	79	■	257	268	285	350	395	419	460	506	-	
386 386 			U	45	78	55	01	9	▲	332	340	388	442	442	464	516	568	-
			U	50	78	55	01	9	▲	332	340	388	442	442	464	516	568	-
			U	60	78	55	01	9	▲	361	374	418	490	490	517	575	633	-
			Width 45, 50, 60															
 the loose pull-out panel will be delivered as a separate package.																		
776 			US	25	78	55	70	R/L ■	343	356	374	427	441	456	485	534	-	
			 Important! Worktop length 27.5 cm															

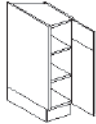

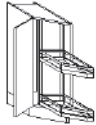

## Base units 78 cm high

Carcase depth 55.5 cm (standard)

■ = Models also available in 34/45.5/61 cm carcass depth (Order no.: ... replace ... 55 ... with 34/45/61)  
 □ = Models also available in 45.5/61 cm carcass depth (order no.: replace ... 55 ... with 45/61)  
 ▲ = Types also available with 61 cm carcass depth (order no.: ... replace ... 55 ... with 61)

Order no.  
W H D

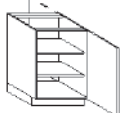
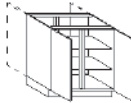

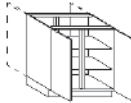
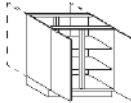
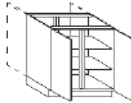




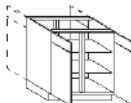
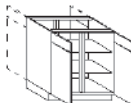
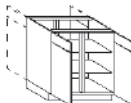

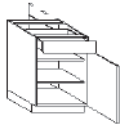
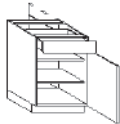

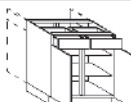
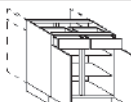
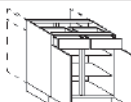



Hinge side: Carcass depth	Price groups								
	1	2	3	4	5	6	7	8	9
R/L ■	343	356	374	427	441	456	485	534	-
R/L ▲	743	750	772	816	834	847	877	965	-

126 646		<b>Base unit angled by 37.2°</b> 25 cm wide 1 panel 12.6 cm attached to 1 door 64.6 cm, 30 cm wide 2 adjustable shelves For adjacent fitting left or right	<b>US 25 78 55 60</b>	R/L ■															
			 <b>Important!</b> Worktop length 27.5 cm																
776		<b>Base unit angled, 37.2°</b> 25 cm wide 1 door 77.6 cm 1 pull-out element 2 adjustable wooden shelves with chrome-plated square rail For adjacent fitting left or right	<b>USVTP25 78 55 07</b>	R/L ▲															
			 <b>Important!</b> Worktop length 27.5 cm																

## Base units as pass-throughs 78 cm high

Carcass depth 55.5 cm (standard)

▲ = Types also available with 61 cm carcass depth (order no.: ... replace ... 55 ... with 61)




776		<b>Base unit as pass-through</b> 1 door 77.6 cm 2 adjustable shelves	<b>UDU 45 78 55 70</b>	R/L ▲	209	220	246	311	326	350	381	419	-					
			<b>UDU 50 78 55 70</b>	R/L ▲	209	220	246	311	350	373	418	460	-					
776		<b>Base unit as pass-through</b> 2 doors 77.6 cm 2 adjustable shelves	<b>UDU 60 78 55 70</b>	R/L ▲	248	261	282	355	408	435	482	530	-					
			 <b>Note:</b> Door hinged front left = door hinged rear right. Always from the perspective of standing in front of the unit. Please order additional doors for the rear side.															
776		<b>Base unit as pass-through</b> 2 doors 77.6 cm 2 adjustable shelves	<b>UDU 80 78 55 70</b>	▲	281	292	324	467	563	611	688	757	-					
			<b>UDU 90 78 55 70</b>	▲	281	292	324	467	563	611	689	758	-					
776		<b>Base unit as pass-through</b> 2 doors 77.6 cm 2 adjustable shelves	<b>UDU 100 78 55 70</b>	▲	294	306	346	494	563	611	690	759	-					
			<b>UDU 120 78 55 70</b>	▲	339	360	413	584	668	722	813	894	-					
776		<b>Base unit as pass-through</b> 2 doors 77.6 cm 2 adjustable shelves	 <b>Note:</b> Door hinged front left = door hinged rear right. Always from the perspective of standing in front of the unit. Please order additional doors for the rear side.															
126 646		<b>Base unit as pass-through</b> 1 panel 12.6 cm attached to 1 door 64.6 cm connected 2 adjustable shelves	<b>UDU 45 78 55 60</b>	R/L ▲	209	220	246	311	326	350	381	419	-					
			<b>UDU 50 78 55 60</b>	R/L ▲	209	220	246	311	350	373	418	460	-					
126 646		<b>Base unit as pass-through</b> 1 panel 12.6 cm attached to 1 door 64.6 cm connected 2 adjustable shelves	<b>UDU 60 78 55 60</b>	R/L ▲	248	261	282	355	408	435	482	530	-					
			 <b>Note:</b> Door hinged front left = door hinged rear right. Always from the perspective of standing in front of the unit. Please order additional doors for the rear side.															
126 646		<b>Base unit as pass-through</b> 2 panels 12.6 cm with 2 doors 64.6 cm 2 adjustable shelves	<b>UDU 80 78 55 60</b>	▲	281	292	324	467	563	611	688	757	-					
			<b>UDU 90 78 55 60</b>	▲	281	292	324	467	563	611	689	758	-					
126 646		<b>Base unit as pass-through</b> 2 panels 12.6 cm with 2 doors 64.6 cm 2 adjustable shelves	<b>UDU 100 78 55 60</b>	▲	294	306	346	494	563	611	690	759	-					
			<b>UDU 120 78 55 60</b>	▲	339	360	413	584	668	722	813	894	-					
126 646		<b>Base unit as pass-through</b> 2 panels 12.6 cm with 2 doors 64.6 cm 2 adjustable shelves	 <b>Note:</b> Door hinged front left = door hinged rear right. Always from the perspective of standing in front of the unit. Please order additional doors for the rear side.															
126 646		<b>Base unit as pass-through</b> 1 drawer 12.6 cm 1 door 64.6 cm 2 adjustable shelves	<b>UDU 45 78 55 10</b>	R/L ▲	263	273	301	372	411	430	469	516	-					
			<b>UDU 50 78 55 10</b>	R/L ▲	263	273	301	372	410	434	473	520	-					
126 646		<b>Base unit as pass-through</b> 1 drawer 12.6 cm 1 door 64.6 cm 2 adjustable shelves	<b>UDU 60 78 55 10</b>	R/L ▲	300	312	350	424	463	492	543	597	-					
			 <b>Note:</b> Door hinged front left = door hinged rear right. Always from the perspective of standing in front of the unit. Please order additional doors for the rear side.															
126 646		<b>Base unit as pass-through</b> 2 drawers 12.6 cm 2 doors 64.6 cm 2 adjustable shelves	<b>UDU 80 78 55 18</b>	▲	404	420	442	606	672	717	795	875	-					
			<b>UDU 90 78 55 18</b>	▲	404	420	447	608	672	717	796	876	-					
126 646		<b>Base unit as pass-through</b> 2 drawers 12.6 cm 2 doors 64.6 cm 2 adjustable shelves	<b>UDU 100 78 55 18</b>	▲	421	432	467	632	672	717	799	879	-					
			<b>UDU 120 78 55 18</b>	▲	469	492	535	725	788	841	934	1027	-					
126 646		<b>Base unit as pass-through</b> 2 drawers 12.6 cm 2 doors 64.6 cm 2 adjustable shelves	 <b>Note:</b> Door hinged front left = door hinged rear right. Always from the perspective of standing in front of the unit. Please order additional doors for the rear side.															
776		<b>Base unit door</b> With fitting drill hole Without fitting, Height: 776 mm	<b>E-TUO 20 78</b>	R/L	52	54	73	105	129	170	186	205	-					
			<b>E-TUO 25 78</b>	R/L	57	68	85	117	147	183	204	224	-					
			<b>E-TUO 30 78</b>	R/L	60	77	98	129	161	207	227	250	-					
			<b>E-TUO 40 78</b>	R/L	70	101	120	157	209	251	275	303	-					
			<b>E-TUO 45 78</b>	R/L	72	111	133	169	228	281	306	337	-					
			<b>E-TUO 50 78</b>	R/L	83	122	144	180	250	301	331	364	-					
			<b>E-TUO 60 78</b>	R/L	84	144	166	207	288	363	398	438	-					
			 width 20 cm: FRAME, VILLAGE 15-S, VILLAGE 15-B, CHALET-S, CHALET-B, OSLO 15, TESSIN 15, BERGEN, LUGANO, CASTELLO, VIVA, TIM 15 are supplied with smooth fronts. width 25 cm: FRAME are supplied with smooth fronts.															



## Base units as pass-throughs 78 cm high

Carcase depth 55.5 cm (standard)

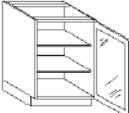


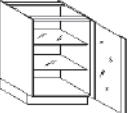


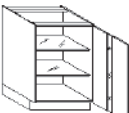


▲ = Types also available with 61 cm carcass depth (order no. ... replace ... 55 ... with 61)

Order no.	W	H	D	Hinge side:	Carcass depth	Price groups								
						1	2	3	4	5	6	7	8	9
646  <b>Base unit door</b> With fitting drill hole Without fitting, Height: 646 mm				R/L		50	52	65	94	116	165	181	199	-
				R/L		52	57	73	105	133	178	194	213	-
				R/L		54	68	84	116	140	183	204	224	-
				R/L		63	85	105	137	181	226	249	274	-
				R/L		66	93	112	146	199	236	260	286	-
				R/L		70	105	123	159	216	258	286	315	-
				R/L		75	122	143	179	249	308	340	374	-
						 <b>width 20 cm: FRAME, VILLAGE 15-S, VILLAGE 15-B, CHALET-S, CHALET-B, OSLO 15, TESSIN 15, BERGEN, LUGANO, CASTELLO, VIVA, TIM 15</b> are supplied with smooth fronts. <b>width 25 cm: FRAME</b> are supplied with smooth fronts.								
126  <b>Fixed panel</b> Height: 126 mm						49	50	52	76	105	112	121	133	-
						50	51	53	78	109	114	123	135	-
						51	52	54	83	113	120	131	144	-
						53	54	59	87	118	133	144	158	-

## Base units with glass door 78 cm high model-specific

Carcass depth 55.5 cm (standard)

■ = Models also available in 34/45.5/61 cm carcass depth (Order no.: ... replace ... 55 ... with 34/45/61) ▲ = Types also available with 61 cm carcass depth (order no. ... replace ... 55 ... with 61)

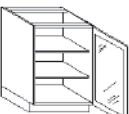

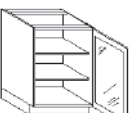

776  <b>Base unit with glass door</b> -model-specific- 1 glass door 77.6 cm 2 adjustable glass shelves	34.0 45.5 55.5 61.0	UG 45 78 55 RA	R/L	■	310	310	319	493	493	518	563	619	-
		UG 50 78 55 RA	R/L	■	319	319	326	501	501	527	573	630	-
		UG 60 78 55 RA	R/L	■	326	326	339	530	530	555	608	669	-
		 <b>Available for:</b> ARTE-B, ARTE-S, ATLANTA-B, ATLANTA-S, BERGEN, CASA-B, CASTELLO, CHALET-B, CHALET-S, CHICAGO, FRAME, LUGANO, LUX-B, MIAMI, NEW OPAL-M, NOBEL-B, NOBEL-S, OPAL-H, ORLANDO-B, ORLANDO-S, PALAZZO, PALERMO-B, PALERMO-S, ROMA-B, ROMA-S, SIGNUM-B, SOFIE-B, SOFIE-S, VINO, VIVA, YORK-B, YORK-S											
 <b>Note:</b> For carcass depth 34 cm with wall mounting. <b>available glass versions:</b> 90 = clear glass 93 = black glass 92 = matt glass 88 = Linea glass													
776  <b>Base unit with glass door</b> -model-specific- 1 semi-frameless glass door 77.6 cm 2 adjustable glass shelves	34.0 45.5 55.5 61.0	UG 45 78 55 LS	R/L	■	341	341	351	525	525	548	594	653	-
		UG 50 78 55 LS	R/L	■	351	351	360	535	535	559	605	666	-
		UG 60 78 55 LS	R/L	■	360	360	370	560	560	586	641	705	-
		 <b>Available for:</b> BAVARIA, EDITION, FENIX INOX, FLORENZ, GARDA, GENT, HPL PRO, MALMÖ, MODENA, MONTANA, MUNICH, NEVADA, OSLO 15, PADUA, PRIMEWOOD TOP, PUR, RESOPAL, RESOPAL PRO, RESOPAL PRO EDGE, RIVA, RUSTY OAK, SHERWOOD, SMART, SMART MIRROR, SMART-M, TESSIN 15, TIM, TIM 15, TOP, TREND, VILLAGE 15-B, VILLAGE 15-S											
 <b>Note:</b> For carcass depth 34 cm with wall mounting. <b>available glass versions:</b> 90 = clear glass 93 = black glass 92 = matt glass 88 = Linea glass													
776  <b>Base unit with glass door</b> -model-specific- 1 semi-frameless glass door 77.6 cm Glass width 5 cm 2 adjustable glass shelves	34.0 45.5 55.5 61.0	UG 45 78 55 LB	R/L	■	341	341	351	525	525	548	594	653	-
		UG 50 78 55 LB	R/L	■	351	351	360	535	535	559	605	666	-
		UG 60 78 55 LB	R/L	■	360	360	370	560	560	586	641	705	-
		 <b>Available for:</b> BAVARIA, EDITION, FENIX INOX, FLORENZ, GARDA, HPL PRO, MALMÖ, MODENA, MONTANA, MUNICH, NEVADA, PADUA, PRIMEWOOD TOP, PUR, RESOPAL, RESOPAL PRO, RESOPAL PRO EDGE, RIVA, RUSTY OAK, SHERWOOD, SMART, SMART MIRROR, SMART-M, TOP, TREND											
 <b>Note:</b> For carcass depth 34 cm with wall mounting. <b>available glass versions:</b> 90 = clear glass 93 = black glass 92 = matt glass 88 = Linea glass													

## Base units with glass door 78 cm high neutral

Carcass depth 55.5 cm (standard)

■ = Models also available in 34/45.5/61 cm carcass depth (Order no.: ... replace ... 55 ... with 34/45/61)

▲ = Types also available with 61 cm carcass depth (order no. ... replace ... 55 ... with 61)

Order no.	W	H	D	Hinge side:	Carcass depth	Glass groups				
						G1	G2	G2S	G5S	G6
776  <b>Base unit with glass door</b> -neutral- 1 AktivGlas door 77.6 cm with „push to open“ fitting 2 adjustable glass shelves	34.0 45.5 55.5 61.0	AKTIV GLAS	UGDA 45 78 55	R/L	■	446	-	-	-	-
			UGDA 50 78 55	R/L	■	451	-	-	-	-
			UGDA 60 78 55	R/L	■	484	-	-	-	-
			 <b>Planning advice:</b> Without drill hole for handle, knobs/handles not possible with „push to open“ fitting. For carcass depth 34 cm with wall mounting.							
776  <b>Base unit with glass front</b> -neutral- 1 glass door 77.6 cm 2 adjustable glass shelves	34.0 45.5 55.5 61.0	UGD 45 78 55	R/L	■	-	527	527	604	911	
		UGD 50 78 55	R/L	■	-	547	547	620	931	
		UGD 60 78 55	R/L	■	-	596	596	675	980	
		 <b>Note:</b> For carcass depth 34 cm with wall mounting.								



## Base units with glass door 78 cm high neutral

Carcase depth 55.5 cm (standard)

■ = Models also available in 34/45.5/61 cm carcise depth (Order no.: ... replace ... 55 ... with 34/45/61)  
 ▲ = Types also available with 61 cm carcise depth (order no. ... replace ... 55 ... with 61)

Order no.  
W H D

Hinge side:	Carcise depth	Glass groups					
		G1	G2	G2S	G5S	G6	
		<b>G 2S</b>					
		<b>G1 AKTIV</b> glass frame 991 Matt glass 992 Translucent black glass	<b>G2 Design front</b> 925 Frame White Agate/Matt glass 935 Premium W. Frame/Matt Glass 940 Macaron Col. Frame/Matt Glass 95 Light grey frame/matt glass 96 Silver Col. Frame/Matt Glass 960 Snow White Frame/Matt Glass 97 Black frame/black glass			<b>G2S aluminium, framed glass door</b> 988 aluminium black, Linea glass 994 Aluminium frame/clear glass 995 aluminium frame/black glass	
		<b>G 5</b>		<b>G 5S</b>		<b>G 6</b>	
			G5S aluminium, door with mullion 996 Alum.frame/clear gl./cross bar		<b>G6 NEW SALON</b> 986 aluminium black, black glass 987 aluminium black, clear glass 989 aluminium matt, bronze-coloured black glass 990 aluminium matt, bronze-coloured clear glass		

## Additional equipment

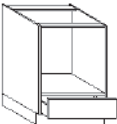



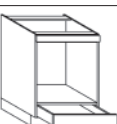

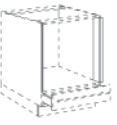
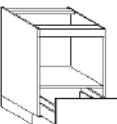

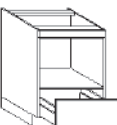

Order no. W H D	Hinge side:	Carcise depth	Decor groups								
			M10	M20	M30	M40	M50	M60	M70	M80	M90
Surcharge for bas cabinets with glass fronts inside and exterior in the same design available in decor groups: S/B/H/MP/F/Z			<b>IDF-U</b>								
			-	-	-	-	802	-	802	802	-

## Oven housings 78 cm high

Carcise depth 55.5 cm (standard)

Please follow the fitting instructions from the appliance manufacturers.  
 ▲ = Types also available with 61 cm carcise depth (order no. ... replace ... 55 ... with 61)


Order no.  
W H D


Hinge side:	Carcise depth	Price groups												
		1	2	3	4	5	6	7	8	9				
175		<b>Oven housing</b> 1 drawer 17.5 cm	<b>UH 60 78 55 10</b>		▲	251	252	260	275	275	284	302	332	-
			 <b>Note:</b> When planning with induction hotplates please take into account the specifications of the manufacturer for the thickness of the worktop. When fronts are laminate-coated, do not forget heat shields. (Model HP...)											
175		<b>Oven housing</b> 1 spacious drawer with 1 panel 17.5 cm high	<b>UH 60 78 55 12</b>		▲	276	280	290	300	302	307	325	358	-
			 <b>Note:</b> When planning with induction hotplates please take into account the specifications of the manufacturer for the thickness of the worktop. When fronts are laminate-coated, do not forget heat shields. (Model HP...) For use only as a slot-in solution or in conjunction with 1 base support panel. Minimum plinth height: 10 cm Only available with laminate drawer.											
126		<b>Oven housing</b> 1 fixed panel 1 open aperture 1 drawer 12.6 cm with low frame	<b>UH 60 78 55 84</b>		▲	294	297	307	325	341	367	407	448	-
			 <b>Note:</b> When fronts are laminate-coated, do not forget heat shields. (Model HP...)											
		<b>Heat shields</b> to protect fronts adjacent to oven silver-coloured price per pair	<b>HP/C</b>			17,10								
386		<b>Base unit for microwave</b> 1 fixed panel 1 open aperture (aperture height 30.8 to 36.2 cm) 1 pull-out 38.6 cm	<b>UM 60 78 55 86</b>		▲	330	331	342	366	366	373	393	432	-
			 <b>Important!</b> Please indicate appliance type and manufacturer when ordering.											
256		<b>Base unit for microwave</b> 1 fixed panel 1 open aperture (aperture height 36.3 to 48.4 cm) 1 pull-out 25.6 cm	<b>UM 60 78 55 83</b>		▲	330	331	342	366	366	373	393	432	-
			<b>UM 90 78 55 83</b>		▲	365	366	373	396	396	406	409	450	-
			 <b>Important!</b> Please indicate appliance type and manufacturer when ordering. With 90 cm width, with full-width panel.											

## Hob base units 78 cm high

Carcise depth 55.5 cm (standard)

Please follow the fitting instructions from the appliance manufacturers. ▲ = Types also available with 61 cm carcise depth (order no. ... replace ... 55 ... with 61)

126 646		<b>Hob base unit</b> 1 panel 12.6 cm 1 cable protective shelf 1 door 64.6 cm 2 adjustable shelves	<b>UK 60 78 55 80</b>		R/L ▲	222	230	257	321	357	377	419	461	-
------------	---	---	-----------------------	--	-------	-----	-----	-----	-----	-----	-----	-----	-----	---

 = extra charge for wall-mounted units, item: **MP-WST**

# Hob base units 78 cm high


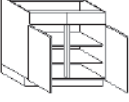
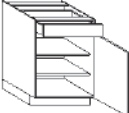

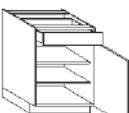

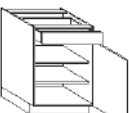
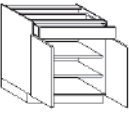
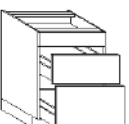
Carcase depth 55.5 cm (standard)

Please follow the fitting instructions from the appliance manufacturers.

▲ = Types also available with 61 cm carcass depth (order no. ... replace ... 55 ... with 61)

Order no.

W H D

Hinge side:	Carcass depth	Price groups																	
		1	2	3	4	5	6	7	8	9									
		Cutout for control panel		UK-AA	22,80														
			<b>Hob base unit</b> 1 full-width panel 12.6 cm 1 cable protective shelf 2 doors 64.6 cm 2 adjustable shelves Left door with buffer strip Without centre panel	UK 90 78 55 80	▲ 240	257	288	411	496	538	606	667	-						
			<b>Hob base unit</b> 2 panels 12.6 cm 1 cable protective shelf 2 doors 64.6 cm 2 adjustable shelves With centre panel	UK 100 78 55 80 UK 120 78 55 80	▲ 255 ▲ 282	267 293	303 337	435 481	496 509	538 550	607 620	668 682	-						
			<b>Hob base unit</b> 1 drawer 12.6 cm with low frame 1 door 64.6 cm 2 adjustable shelves	UKI 60 78 55 10	R/L ▲ 338	349	376	442	477	499	543	597	-						
			<b>Hob base unit</b> 1 drawer 12.6 cm with low frame with full-width panel 2 doors 64.6 cm 2 adjustable shelves Left door with buffer strip Without centre panel	UKI 80 78 55 10 UKI 90 78 55 10 UKI 100 78 55 10 UKI 120 78 55 10	▲ 392 ▲ 392 ▲ 401 ▲ 409	402 402 411 420	431 431 442 451	566 566 579 589	620 620 633 646	656 656 671 686	723 723 739 756	795 795 813 832	-						
			Width 80, 100 Not available for: GENT, INTARSIA, OSLO 15, TESSIN 15, TIM 15, VILLAGE 15-B, VILLAGE 15-S Width 90, 120 Not available for: INTARSIA																
			<b>Hob base unit for induction hobs</b> 1 drawer 12.6 cm with low frame 1 heat shield 1 door 64.6 cm 2 adjustable shelves	UKI 60 78 55 6	R/L ▲ 417	426	458	522	553	578	621	683	-						
			<b>Hob base unit for induction hobs</b> 1 drawer 12.6 cm with low frame with full-width panel 1 heat shield 2 doors 64.6 cm 2 adjustable shelves Left door with buffer strip Without centre panel	UKI 80 78 55 6 UKI 90 78 55 6 UKI 100 78 55 6 UKI 120 78 55 6	▲ 493 ▲ 499 ▲ 525 ▲ 555	502 508 534 568	533 538 566 601	665 671 700 735	719 724 754 789	758 763 792 829	824 829 860 900	906 912 946 990	-						
			Width 80, 100 Not available for: GENT, INTARSIA, OSLO 15, TESSIN 15, TIM 15, VILLAGE 15-B, VILLAGE 15-S Width 90, 120 Not available for: INTARSIA																
			<b>Hob base unit for induction hobs</b> 1 drawer 12.6 cm with carcass depth 45.5 cm with low frame 1 heat shield 1 door 64.6 cm 2 adjustable shelves	UKI 60 78 55 61	R/L ▲ 417	426	458	522	553	578	621	683	-						
			Important! Cutlery organisers are not available for this article.																
			<b>Hob base unit for induction hobs</b> 1 drawer 12.6 cm with carcass depth 45.5 cm with low frame with full-width panel 1 heat shield 2 doors 64.6 cm Left door with buffer strip Without centre panel 2 adjustable shelves	UKI 80 78 55 61 UKI 90 78 55 61 UKI 100 78 55 61 UKI 120 78 55 61	▲ 493 ▲ 499 ▲ 525 ▲ 555	502 508 534 568	533 538 566 601	665 671 700 735	719 724 754 789	758 763 792 829	824 829 860 900	906 912 946 990	-						
			Width 80, 100 Not available for: GENT, INTARSIA, OSLO 15, TESSIN 15, TIM 15, VILLAGE 15-B, VILLAGE 15-S Width 90, 120 Not available for: INTARSIA																
			Important! Cutlery organisers are not available for this article.																
			<b>Hob base unit</b> 1 panel 12.6 cm 1 cable protective shelf 1 pull-out 25.6 cm 1 pull-out 38.6 cm	UK 60 78 55 82 UK 70 78 55 82 UK 80 78 55 82 UK 90 78 55 82 UK 100 78 55 82 UK 120 78 55 82	▲ 453 ▲ 726 ▲ 726 ▲ 726 ▲ 754 ▲ 779	465 744 744 744 776 805	515 831 831 831 865 900	596 856 856 856 897 932	596 871 871 871 909 947	623 922 922 922 964 1005	681 1024 1024 1024 1070 1115	749 1126 1126 1126 1177 1227	-						
		Cutout for control panel		UK-AA	22,80														

# Hob base units 78 cm high

Carcase depth 55.5 cm (standard)

Please follow the fitting instructions from the appliance manufacturers.  
 ▲ = Types also available with 61 cm carcass depth (order no. ... replace ... 55 ... with 61)

Order no.  
W H D

Hinge side:	Carcass depth	Price groups									
		1	2	3	4	5	6	7	8	9	
UK	▲	60 78 55 820	453	465	515	596	596	623	681	749	-
		70 78 55 820	726	744	831	856	871	922	1024	1126	-
		80 78 55 820	726	744	831	856	871	922	1024	1126	-
		90 78 55 820	726	744	831	856	871	922	1024	1126	-
		100 78 55 820	754	776	865	897	909	964	1070	1177	-
		120 78 55 820	779	805	900	932	947	1005	1115	1227	-
UK-AA		22,80									
UKI	▲	60 78 55 12	577	586	633	701	701	732	787	866	-
		70 78 55 12	861	876	962	1045	1062	1110	1212	1333	-
		80 78 55 12	861	876	962	1045	1062	1110	1212	1333	-
		90 78 55 12	861	876	962	1045	1062	1110	1212	1333	-
		100 78 55 12	887	908	995	1082	1098	1152	1256	1382	-
		120 78 55 12	915	934	1029	1115	1136	1196	1303	1433	-
UKI	▲	60 78 55 13	577	586	633	701	701	732	787	866	-
		70 78 55 13	861	876	962	1045	1062	1110	1212	1333	-
		80 78 55 13	861	876	962	1045	1062	1110	1212	1333	-
		90 78 55 13	861	876	962	1045	1062	1110	1212	1333	-
		100 78 55 13	887	908	995	1082	1098	1152	1256	1382	-
		120 78 55 13	915	934	1029	1118	1136	1196	1303	1433	-
UKI	▲	60 78 55 4	655	666	712	778	778	809	863	949	-
		80 78 55 4	965	978	1063	1144	1160	1208	1311	1442	-
		90 78 55 4	970	985	1068	1150	1167	1216	1317	1449	-
		100 78 55 4	1012	1032	1120	1202	1220	1274	1379	1517	-
		120 78 55 4	1063	1083	1178	1264	1279	1340	1448	1593	-
UKI	▲	60 78 55 41	655	666	712	778	778	809	863	949	-
		80 78 55 41	965	978	1063	1144	1160	1208	1311	1442	-
		90 78 55 41	970	985	1068	1150	1167	1216	1317	1449	-
		100 78 55 41	1012	1032	1120	1202	1220	1274	1379	1517	-
		120 78 55 41	1063	1083	1178	1264	1279	1340	1448	1593	-
UKI	▲	60 78 55 120	577	586	633	701	701	732	787	866	-
		70 78 55 120	861	876	962	1045	1062	1110	1212	1333	-
		80 78 55 120	861	876	962	1045	1062	1110	1212	1333	-
		90 78 55 120	861	876	962	1045	1062	1110	1212	1333	-
		100 78 55 120	887	908	995	1082	1098	1152	1256	1382	-
		120 78 55 120	915	934	1029	1115	1136	1196	1303	1433	-
UKI	▲	60 78 55 122	577	586	633	701	701	732	787	866	-
		70 78 55 122	861	876	962	1045	1062	1110	1212	1333	-
		80 78 55 122	861	876	962	1045	1062	1110	1212	1333	-
		90 78 55 122	861	876	962	1045	1062	1110	1212	1333	-
		100 78 55 122	887	908	995	1082	1098	1152	1256	1382	-
		120 78 55 122	915	934	1029	1115	1136	1196	1303	1433	-
UKI	▲	60 78 55 40	655	666	712	778	778	809	863	949	-
		80 78 55 40	965	978	1063	1144	1160	1208	1311	1442	-
		90 78 55 40	970	985	1068	1150	1167	1216	1317	1449	-
		100 78 55 40	1012	1032	1120	1202	1220	1274	1379	1517	-
		120 78 55 40	1063	1083	1178	1264	1279	1340	1448	1593	-
UKI	▲	60 78 55 42	655	666	712	778	778	809	863	949	-
		80 78 55 42	965	978	1063	1144	1160	1208	1311	1442	-
		90 78 55 42	970	985	1068	1150	1167	1216	1317	1449	-
		100 78 55 42	1012	1032	1120	1202	1220	1274	1379	1517	-
		120 78 55 42	1063	1083	1178	1264	1279	1340	1448	1593	-
UKI	▲	60 78 55 22	682	691	737	803	803	834	889	978	-
		70 78 55 22	966	978	1063	1145	1159	1213	1312	1443	-
		80 78 55 22	966	978	1063	1145	1159	1213	1312	1443	-
		90 78 55 22	966	978	1063	1145	1159	1213	1312	1443	-
		100 78 55 22	995	1015	1106	1193	1206	1264	1366	1503	-
		120 78 55 22	1029	1054	1150	1243	1255	1321	1428	1571	-

▲ = extra charge for wall-mounted units, item: MP-WST

## Hob base units 78 cm high

Carcase depth 55.5 cm (standard)

Please follow the fitting instructions from the appliance manufacturers.

▲ = Types also available with 61 cm carcass depth (order no. ... replace ... 55 ... with 61)

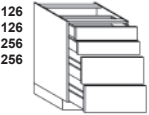
Order no.  
W H D

Hinge side:	Carcass depth	Price groups									
		1	2	3	4	5	6	7	8	9	
▲	55.5	UKI 60 78 55 23	682	691	737	803	803	834	889	978	-
		UKI 70 78 55 23	966	978	1063	1145	1159	1213	1312	1443	-
		UKI 80 78 55 23	966	978	1063	1145	1159	1213	1312	1443	-
		UKI 90 78 55 23	966	978	1063	1145	1159	1213	1312	1443	-
		UKI 100 78 55 23	995	1015	1106	1193	1206	1264	1366	1503	-
		UKI 120 78 55 23	1029	1054	1150	1243	1255	1321	1428	1571	-
▲	55.5	UKI 60 78 55 5	762	771	816	881	881	911	967	1064	-
		UKI 80 78 55 5	1066	1080	1165	1247	1258	1312	1411	1552	-
		UKI 90 78 55 5	1072	1087	1171	1252	1266	1319	1416	1558	-
		UKI 100 78 55 5	1120	1138	1229	1313	1328	1385	1488	1637	-
		UKI 120 78 55 5	1178	1200	1297	1388	1398	1464	1570	1727	-
▲	55.5	UKI 60 78 55 51	762	771	816	881	881	911	967	1064	-
		UKI 80 78 55 51	1066	1080	1165	1247	1258	1312	1411	1552	-
		UKI 90 78 55 51	1072	1087	1171	1252	1266	1319	1416	1558	-
		UKI 100 78 55 51	1120	1138	1229	1313	1328	1385	1488	1637	-
		UKI 120 78 55 51	1178	1200	1297	1388	1398	1464	1570	1727	-
▲	55.5	UK 60 78 55 81	498	508	555	624	624	655	710	781	-
		UK 70 78 55 81	784	801	884	972	986	1035	1136	1250	-
		UK 80 78 55 81	784	801	884	972	986	1035	1136	1250	-
		UK 90 78 55 81	784	801	884	972	986	1035	1136	1250	-
		UK 100 78 55 81	810	831	920	1008	1024	1078	1183	1301	-
		UK 120 78 55 81	838	860	954	1044	1063	1120	1229	1352	-



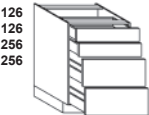
### Hob base unit

1 drawer 12.6 cm with carcass depth 45.5 cm with low frame  
1 cable protective shelf  
1 drawer 12.6 cm  
2 pull-outs 25.6 cm



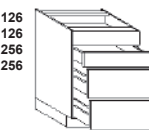
### Hob base unit for induction hobs

1 drawer 12.6 cm with low frame  
1 heat shield  
1 drawer 12.6 cm  
2 pull-outs 25.6 cm



### Hob base unit for induction hobs

1 drawer 12.6 cm with carcass depth 45.5 cm with low frame  
1 heat shield  
1 drawer 12.6 cm  
2 pull-outs 25.6 cm



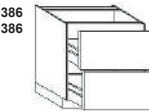
### Hob base unit

1 panel 12.6 cm  
1 cable protective shelf  
1 drawer 12.6 cm  
2 pull-outs 25.6 cm

## Hob base units 78 cm high for hob extractors

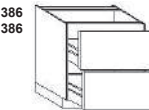
Carcass depth 55.5 cm (standard)

Please follow the fitting instructions from the appliance manufacturers. ▲ = Types also available with 61 cm carcass depth (order no. ... replace ... 55 ... with 61)



### Hob base unit for hob extractor

1 fixed inside panel  
2 pull-outs 38.6 cm with wooden rear panel



### Hob base unit for hob extractor

1 fixed inside panel  
2 pull-outs 38.6 cm

UDK 70 78 55 028	▲	863	880	967	1052	1066	1117	1217	1339	-
UDK 80 78 55 028	▲	863	880	967	1052	1066	1117	1217	1339	-
UDK 90 78 55 028	▲	863	880	967	1052	1066	1117	1217	1339	-
UDK 100 78 55 028	▲	884	900	988	1075	1092	1145	1250	1375	-
UDK 120 78 55 028	▲	900	920	1010	1102	1117	1177	1278	1406	-



Note:

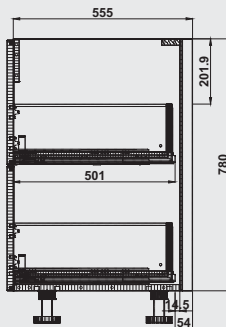
The pull-outs are adapted to the respective hob extractor type.  
We will not assume any liability for damage caused by moisture.

UDK 80 78 55 02	▲	747	764	850	935	950	1003	1101	1211	-
UDK 90 78 55 02	▲	747	764	850	935	950	1003	1101	1211	-
UDK 100 78 55 02	▲	767	783	871	961	976	1029	1133	1246	-
UDK 120 78 55 02	▲	783	803	895	986	1003	1061	1163	1279	-



Note:

The pull-outs are adapted to the respective hob extractor type.  
We will not assume any liability for damage caused by moisture.



# Hob base units 78 cm high for hob extractors

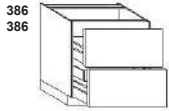
Carcase depth 55.5 cm (standard)

Please follow the fitting instructions from the appliance manufacturers.

▲ = Types also available with 61 cm carcass depth (order no. ... replace ... 55 ... with 61)

Order no.  
W H D

Hinge side:	Carcass depth	Price groups								
		1	2	3	4	5	6	7	8	9
▲		880	894	978	1064	1077	1128	1226	1349	-
▲		884	897	982	1067	1080	1132	1230	1353	-
▲		907	924	1014	1098	1113	1168	1270	1397	-
▲		958	976	1071	1156	1173	1230	1336	1470	-



## Hob base unit for hob extractor

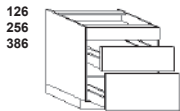
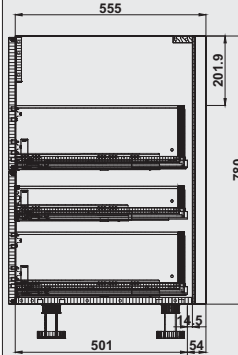
- 1 fixed inside panel
- 2 pull-outs 38.6 cm
- 1 internal drawer

UDK	80	78	55	022																
UDK	90	78	55	022																
UDK	100	78	55	022																
UDK	120	78	55	022																



### Note:

The pull-outs are adapted to the respective hob extractor type. We will not assume any liability for damage caused by moisture.



## Hob base unit for hob extractor

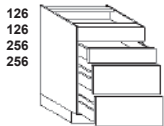
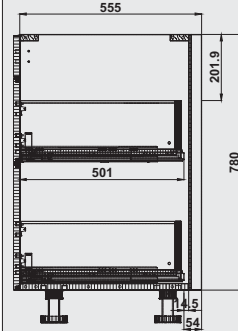
- 1 panel 12.6 cm
- 1 pull-out 25.6 cm
- 1 pull-out 38.6 cm

UDK	80	78	55	82																
UDK	90	78	55	82																
UDK	100	78	55	82																
UDK	120	78	55	82																



### Note:

The pull-outs are adapted to the respective hob extractor type. We will not assume any liability for damage caused by moisture.



## Hob base unit for hob extractor

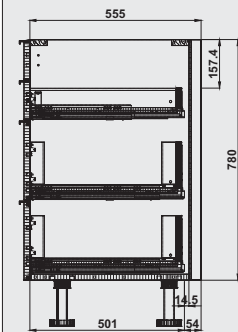
- 1 panel 12.6 cm
- 1 drawer 12.6 cm
- 2 pull-outs 25.6 cm

UDK	80	78	55	81																
UDK	90	78	55	81																
UDK	100	78	55	81																
UDK	120	78	55	81																



### Note:

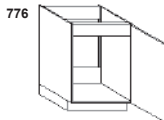
The pull-outs are adapted to the respective hob extractor type. We will not assume any liability for damage caused by moisture.



# Sink carcasses 78 cm high

Carcass depth 55.5 cm (standard)

□ = Models also available in 45.5/61 cm carcass depth (order no.: replace ... 55 ... with 45/61) ▲ = Types also available with 61 cm carcass depth (order no. ... replace ... 55 ... with 61)



## Sink carcass

- 1 door 77.6 cm
- 1 inside panel
- 1 aluminium protective shelf

US	40	78	55	701	R/L	▲	205	215	231	292	325	347	377	415	-
US	45	78	55	701	R/L	▲	207	216	233	293	326	349	378	416	-
US	50	78	55	701	R/L	▲	208	217	235	294	329	357	389	428	-
US	60	78	55	701	R/L	▲	236	252	270	337	373	398	437	481	-



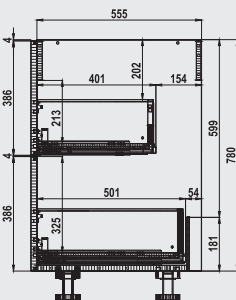
# Sink carcases 78 cm high

Carcase depth 55.5 cm (standard)

□ = Models also available in 45.5/61 cm carcase depth (order no.: replace ... 55 ... with 45/61)  
 ▲ = Types also available with 61 cm carcase depth (order no. ... replace ... 55 ... with 61)

Order no.  
 W H D

Hinge side:	Carcase depth	Price groups										
		1	2	3	4	5	6	7	8	9		
▲	□	US 80 78 55 701	270	287	315	446	517	557	622	684	-	
		US 90 78 55 701	275	290	319	448	519	559	625	688	-	
		US 100 78 55 701	292	302	334	479	523	561	629	692	-	
		US 120 78 55 701	331	356	396	552	602	647	730	803	-	
R/L	□	US 30 78 55 702	181	191	211	268	303	323	360	396	-	
		US 40 78 55 702	181	191	211	268	303	323	360	396	-	
		US 45 78 55 702	181	191	211	268	303	323	360	396	-	
		US 50 78 55 702	181	191	211	268	303	329	365	402	-	
R/L	□	US 60 78 55 702	211	224	245	312	349	369	410	451	-	
		□	US 80 78 55 702	235	251	277	412	481	522	584	642	-
			US 90 78 55 702	235	251	277	412	481	522	586	645	-
			US 100 78 55 702	250	260	295	437	481	522	587	646	-
US 120 78 55 702	288		308	349	506	557	603	685	754	-		
R/L	▲	US 40 78 55 601	205	215	231	292	325	347	377	415	-	
		US 45 78 55 601	207	216	230	293	326	349	378	416	-	
		US 50 78 55 601	208	217	235	294	329	357	389	428	-	
		US 60 78 55 601	236	252	270	337	373	398	437	481	-	
▲	□	US 80 78 55 601	270	287	315	446	517	557	622	684	-	
		US 90 78 55 601	275	290	319	448	519	559	625	688	-	
		US 100 78 55 601	292	302	334	479	523	561	629	692	-	
		US 120 78 55 601	331	356	396	552	602	647	730	803	-	
R/L	□	US 30 78 55 602	181	191	211	268	303	323	360	396	-	
		US 40 78 55 602	181	191	211	268	303	323	360	396	-	
		US 45 78 55 602	181	191	211	268	303	323	360	396	-	
		US 50 78 55 602	181	191	211	268	303	329	365	402	-	
R/L	□	US 60 78 55 602	211	224	245	312	349	369	410	451	-	
		□	US 80 78 55 602	235	251	277	412	481	522	584	642	-
			US 90 78 55 602	235	251	277	412	481	522	586	645	-
			US 100 78 55 602	250	260	295	437	481	522	587	646	-
US 120 78 55 602	288		308	349	506	557	603	685	754	-		
R/L	▲	US 80 78 55 13	292	302	332	474	530	566	631	694	-	
		US 90 78 55 13	292	302	332	474	530	566	633	696	-	
		US 100 78 55 13	301	315	349	494	530	566	637	701	-	
		US 120 78 55 13	343	367	408	562	601	647	728	801	-	
▲	□	US 70 78 55 026	884	898	982	1066	1080	1133	1231	1354	-	
		US 80 78 55 026	884	898	982	1066	1080	1133	1231	1354	-	
		US 90 78 55 026	884	898	982	1066	1080	1133	1231	1354	-	
		US 100 78 55 026	900	916	1004	1091	1106	1160	1262	1388	-	
		US 120 78 55 026	913	939	1028	1117	1132	1187	1293	1422	-	



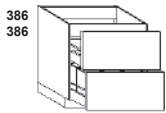
# Sink carcasses 78 cm high

Carcase depth 55.5 cm (standard)

□ = Models also available in 45.5/61 cm carcass depth (order no.: replace ... 55 ... with 45/61)  
 ▲ = Types also available with 61 cm carcass depth (order no. ... replace ... 55 ... with 61)

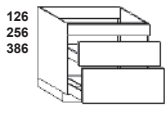
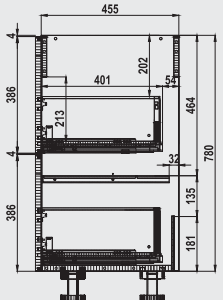
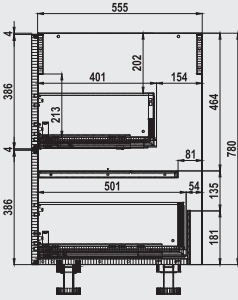
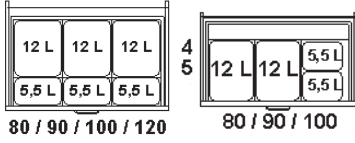
Order no.  
 W H D

Hinge side:	Carcass depth	Price groups									
		1	2	3	4	5	6	7	8	9	
□	386	US 80 78 55 027	1257	1269	1356	1429	1444	1497	1594	1753	-
	386	US 90 78 55 027	1260	1272	1359	1432	1448	1500	1597	1757	-
	386	US 100 78 55 027	1282	1302	1389	1467	1481	1534	1638	1802	-
	386	US 120 78 55 027	▲ 1311	1337	1427	1507	1521	1576	1681	1849	-
▲	126	US 70 78 55 826	859	879	966	988	1005	1052	1152	1267	-
	256	US 80 78 55 826	▲ 859	879	966	988	1005	1052	1152	1267	-
	386	US 90 78 55 826	▲ 859	879	966	988	1005	1052	1152	1267	-
	386	US 100 78 55 826	▲ 886	906	996	1024	1042	1095	1198	1318	-
386	US 120 78 55 826	▲ 909	936	1032	1062	1080	1136	1248	1373	-	
□	126	US 80 78 55 827	1219	1239	1327	1340	1356	1405	1506	1657	-
	256	US 90 78 55 827	1219	1239	1327	1340	1356	1405	1506	1657	-
	386	US 100 78 55 827	1254	1275	1365	1384	1401	1454	1558	1714	-
	386	US 120 78 55 827	▲ 1292	1319	1413	1433	1453	1508	1592	1751	-
▲	126	US 70 78 55 828	859	879	966	988	1005	1052	1152	1267	-
	256	US 80 78 55 828	▲ 859	879	966	988	1005	1052	1152	1267	-
	386	US 90 78 55 828	▲ 859	879	966	988	1005	1052	1152	1267	-
	386	US 100 78 55 828	▲ 886	906	996	1024	1042	1095	1198	1318	-
386	US 120 78 55 828	▲ 909	936	1032	1062	1080	1136	1248	1373	-	



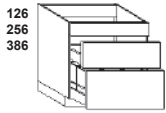
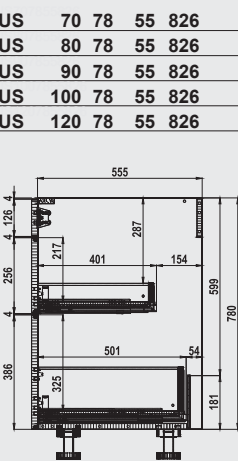
## Sink carcass

- 1 pull-out 38.6 cm, 45.5 cm deep with full-width panel
- with wooden rear panel reduced in height
- 1 moulded part for drain set
- 1 pull-out 38.6 cm with full-width panel
- 1 waste system in bottom pull-out



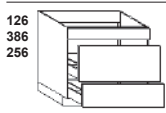
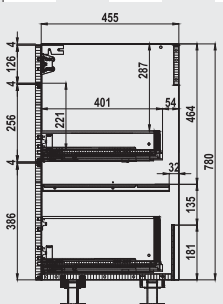
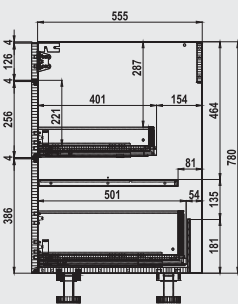
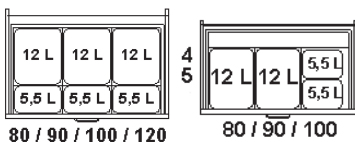
## Sink carcass

- 1 full-width panel 12.6 cm
- 1 drawer 25.6 cm, 45.5 cm deep with full-width panel
- 1 moulded part for drain set
- 1 pull-out 38.6 cm with full-width panel



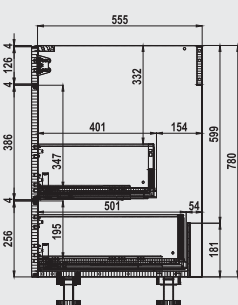
## Sink carcass

- 1 full-width panel 12.6 cm
- 1 drawer 25.6 cm, 45.5 cm deep with full-width panel
- 1 moulded part for drain set
- 1 pull-out 38.6 cm with full width panel
- 1 waste system in bottom pull-out



## Sink carcass

- 1 full-width panel 12.6 cm
- 1 pull-out 38.6 cm, 45.5 cm deep with full-width panel
- with wooden rear panel reduced in height
- 1 moulded part for drain set
- 1 pull-out 25.6 cm with full-width panel

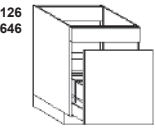




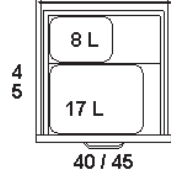
# Sink carcasses 78 cm high

Carcass depth 55.5 cm (standard)

□ = Models also available in 45.5/61 cm carcass depth (order no.: replace ... 55 ... with 45/61)  
 ▲ = Types also available with 61 cm carcass depth (order no. ... replace ... 55 ... with 61)



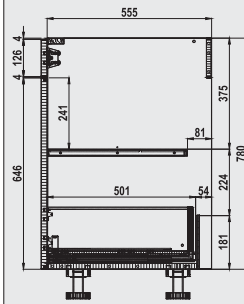
**Sink carcass**  
 1 panel 78 cm  
 1 pull-out 64.6 cm  
 with waste bins



4  
5

Order no.  
W H D

US 30 78 55 88  
 US 40 78 55 88  
 US 45 78 55 88

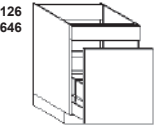
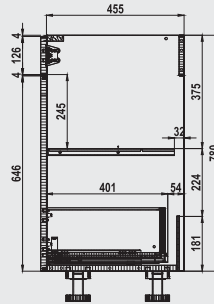


Hinge side:

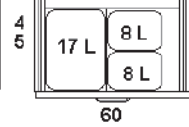
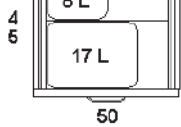
Carcass depth

## Price groups

	1	2	3	4	5	6	7	8	9
▲	597	603	633	700	717	740	777	855	-
□	597	603	633	700	717	740	777	855	-
□	597	603	633	700	717	740	777	855	-



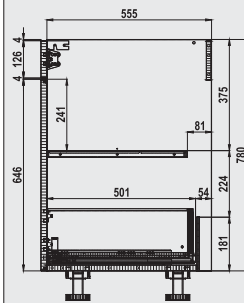
**Sink carcass**  
 1 panel 12.6 cm  
 1 pull-out 64.6 cm  
 with waste bins



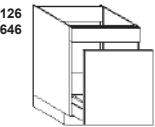
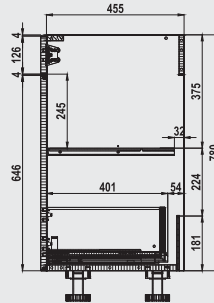
4  
6

4  
5

US 50 78 55 88  
 US 60 78 55 88

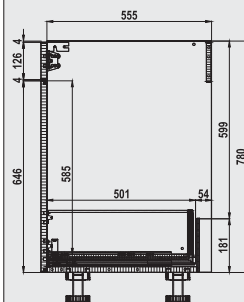


□	631	638	667	731	749	773	807	888	-
□	660	674	712	773	788	812	849	934	-



**Sink carcass**  
 1 panel 12.6 cm  
 1 pull-out 64.6 cm  
 without waste bin

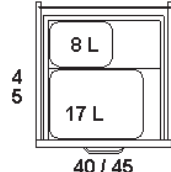
US 30 78 55 81  
 US 40 78 55 81  
 US 45 78 55 81  
 US 50 78 55 81  
 US 60 78 55 81



▲	302	312	329	386	424	441	478	526	-
▲	302	312	329	386	424	441	478	526	-
▲	302	312	329	386	424	441	478	526	-
▲	302	312	329	386	424	445	481	529	-
▲	330	343	368	431	469	487	532	585	-



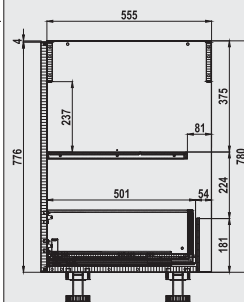
**Sink carcass**  
 1 inside panel  
 1 pull-out 77.6 cm  
 with waste bins



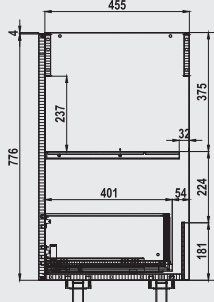
4  
5



US 30 78 55 881  
 US 40 78 55 881  
 US 45 78 55 881



▲	597	603	633	700	717	740	777	855	-
□	597	603	633	700	717	740	777	855	-
□	597	603	633	700	717	740	777	855	-



# Sink carcasses 78 cm high

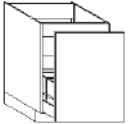
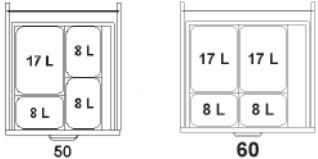
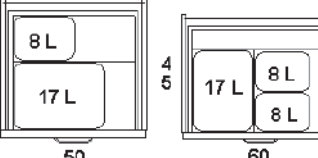
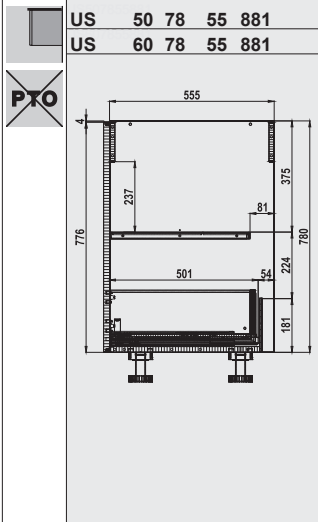
Carcase depth 55.5 cm (standard)

□ = Models also available in 45.5/61 cm carcass depth (order no.: replace ... 55 ... with 45/61)  
 ▲ = Types also available with 61 cm carcass depth (order no.: replace ... 55 ... with 61)

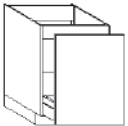
Order no.  
 W H D

Hinge side: Carcass depth	Price groups								
	1	2	3	4	5	6	7	8	9
□	631	638	667	731	749	773	807	888	-
	660	674	712	773	788	812	849	934	-
▲	302	312	329	386	424	441	478	526	-
	302	312	329	386	424	441	478	526	-
	302	312	329	386	424	441	478	526	-
	302	312	329	386	424	445	481	529	-
	330	343	368	431	469	487	532	585	-
▲	207	216	233	293	326	349	378	416	-
	208	217	235	294	329	357	389	428	-
	236	252	270	337	373	398	437	481	-
▲	207	216	233	293	326	349	378	416	-
	208	217	235	294	329	357	389	428	-
	236	252	270	337	373	398	437	481	-
▲	561	571	587	648	682	703	735	809	-
	568	578	596	653	689	717	747	822	-
	612	626	646	711	748	772	812	893	-

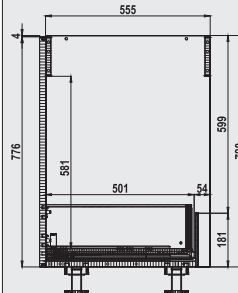
**776 Sink carcass**  
 1 inside panel  
 1 pull-out 77.6 cm  
 with waste bins

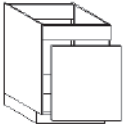
**776 Sink carcass**  
 1 inside panel  
 1 pull-out 77.6 cm  
 without waste bin



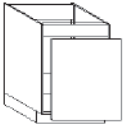
PTO



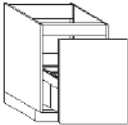
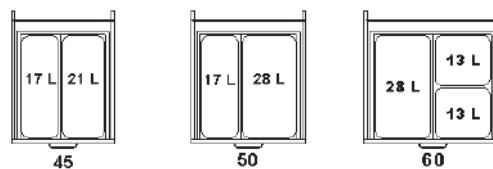
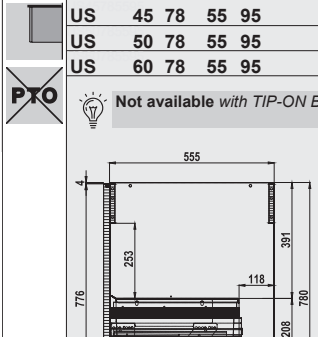
**126 646 Sink carcass for waste bin**  
 1 panel 12.6 cm  
 1 front 64.6 cm, separate  
 1 aluminium protective shelf



**776 Sink carcass for waste bin**  
 1 inside panel  
 1 front 77.6 cm, separate  
 1 aluminium protective shelf



**776 Sink carcass**  
 1 pull-out with front panel 77.6 cm  
 with frame and waste bin  
 for dropping in (Hailo)  
 1 inside panel

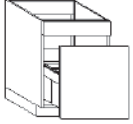




# Sink carcasses 78 cm high

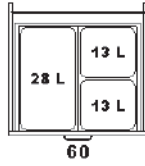
Carcase depth 55.5 cm (standard)

□ = Models also available in 45.5/61 cm carcass depth (order no.: replace ... 55 ... with 45/61)  
 ▲ = Types also available with 61 cm carcass depth (order no. ... replace ... 55 ... with 61)

126  
646



**Sink carcass**  
 1 panel 12.6 cm  
 1 pull-out 64.6 cm  
 with frame and waste bin  
 for dropping in (Hailo)

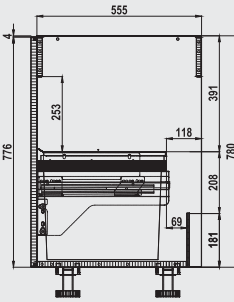


Order no.  
W H D

US	45	78	55	951
US	50	78	55	951
US	60	78	55	951

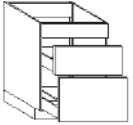


Not available with TIP-ON Blumotion



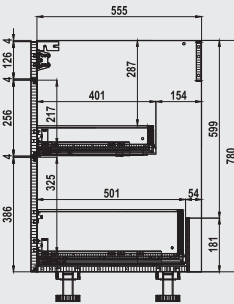
Hinge side:	Carcass depth	Price groups								
		1	2	3	4	5	6	7	8	9
▲	55.5	561	571	587	648	682	703	735	809	-
▲	61	568	578	596	653	689	717	747	822	-
▲	61	612	626	646	711	748	772	812	893	-
□	45.5	789	802	849	917	930	947	1005	1106	-
▲	55.5	485	496	541	613	628	646	699	769	-

126  
256  
386

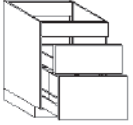


**Sink carcass**  
 1 panel 12.6 cm  
 1 drawer 25.6 cm, 45.5 cm deep  
 1 moulded part for drain set  
 1 pull-out 38.6 cm

US	60	78	55	820
----	----	----	----	-----

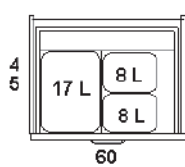
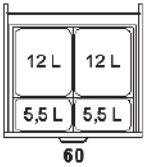
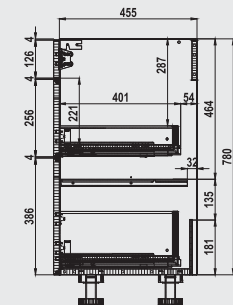
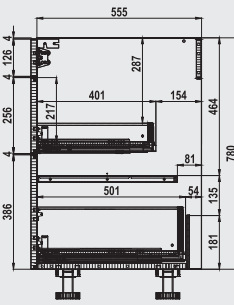


126  
256  
386

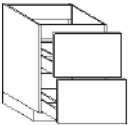


**Sink carcass**  
 1 panel 12.6 cm  
 1 drawer 25.6 cm, 45.5 cm deep  
 1 moulded part for drain set  
 1 pull-out 38.6 cm  
 1 waste system in bottom pull-out

US	60	78	55	821
----	----	----	----	-----

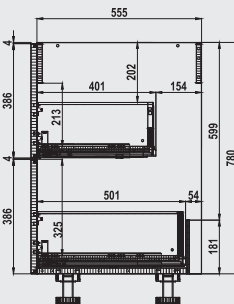


386  
386



**Sink carcass**  
 1 pull-out 38.6 cm, 45.5 cm deep  
 with wooden rear panel  
 reduced in height 1 inside panel  
 1 moulded part for drain set  
 1 pull-out 38.6 cm

US	60	78	55	020
----	----	----	----	-----



# Sink carcasses 78 cm high

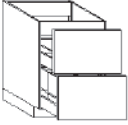
Carcase depth 55.5 cm (standard)

□ = Models also available in 45.5/61 cm carcass depth (order no.: replace ... 55 ... with 45/61)  
 ▲ = Types also available with 61 cm carcass depth (order no. ... replace ... 55 ... with 61)

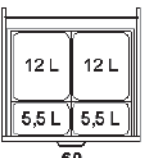
Order no.  
W H D

Hinge side: Carcass depth	Price groups								
	1	2	3	4	5	6	7	8	9

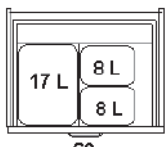
**386**  
**386**



**Sink carcass**  
 1 pull-out 38.6 cm, 45.5 cm deep with wooden rear panel  
 reduced in height 1 inside panel  
 1 moulded part for drain set  
 1 pull-out 38.6 cm  
 1 waste system in bottom pull-out

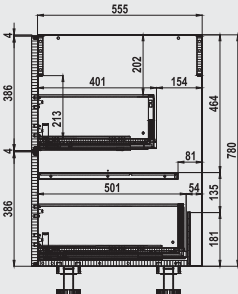


60



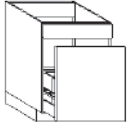
4 5  
60

**US 60 78 55 021**

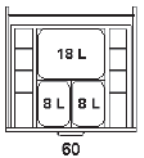


□	735	743	789	855	869	884	940	1034	-
---	-----	-----	-----	-----	-----	-----	-----	------	---

**126**  
**646**

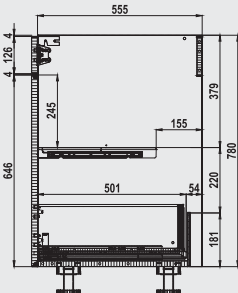


**Sink carcass**  
 1 fixed panel 12.6 cm  
 1 pull-out with front panel 64.6 cm with Hailo Separato-K waste separation system with extendable lid




60

**US 60 78 55 93**



▲	536	549	573	638	675	692	737	811	-
---	-----	-----	-----	-----	-----	-----	-----	-----	---

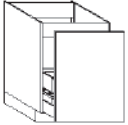


**Electronic opening assistance for pull-outs Hailo Libero 3.0**  
 For base units from 300 mm to 1200 mm width

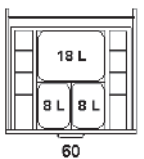
**EL-AZ**

	291								
--	-----	--	--	--	--	--	--	--	--

**776**

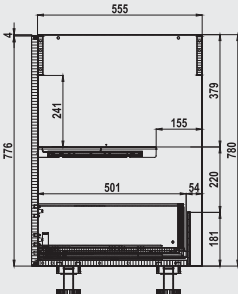


**Sink carcass**  
 1 inside panel  
 1 pull-out with front panel 77.6 cm with Hailo Separato-K waste separation system with extendable lid



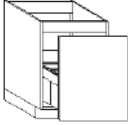
60

**US 60 78 55 931**




▲	536	549	573	638	675	692	737	811	-
---	-----	-----	-----	-----	-----	-----	-----	-----	---

**776**

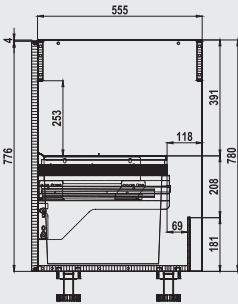


**Sink carcass**  
 1 pull-out with front panel 77.6 cm with frame and 2 waste bins for dropping in (Hailo)  
 1 inside panel



60

**US 60 78 55 96**



▲	612	626	646	711	748	772	812	893	-
---	-----	-----	-----	-----	-----	-----	-----	-----	---

**Extra charge Sink carcass with full back panel**

**SA50SVR**

	34								
--	----	--	--	--	--	--	--	--	--

□ = Merchandise net

■ = extra charge for wall-mounted units, item: **MP-WST**

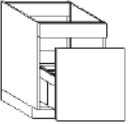
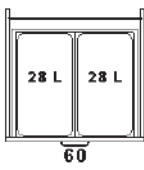
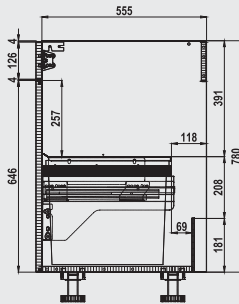
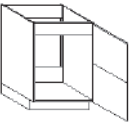
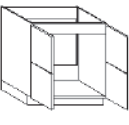
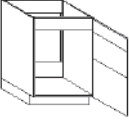
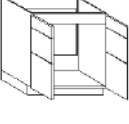
# Sink carcasses 78 cm high

Carcase depth 55.5 cm (standard)

□ = Models also available in 45.5/61 cm carcass depth (order no.: replace ... 55 ... with 45/61)  
 ▲ = Types also available with 61 cm carcass depth (order no. ... replace ... 55 ... with 61)

Order no.  
W H D

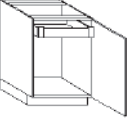
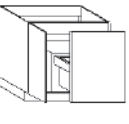
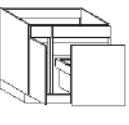
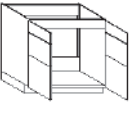
## Price groups

	Hinge side:	Carcass depth	Price groups										
			1	2	3	4	5	6	7	8	9		
<p>126 646</p>  <p><b>Sink carcass</b>                      1 fixed panel 12.6 cm                      1 pull-out 64.6 cm with frame and 2 waste bins for dropping in (Hailo)</p> 	<b>PXO</b>	US	<b>60 78 55 961</b>	▲	612	626	646	711	748	772	812	893	-
<p>Not available with TIP-ON</p> 													
<p>386 386</p>  <p><b>Sink carcass</b>                      1 door consisting of                      1 panel 38.6 cm attached to 1 panel 38.6 cm                      1 inside panel                      1 aluminium protective shelf</p>		US	<b>40 78 55 721</b>	R/L ▲	205	215	231	292	325	347	377	415	-
		US	<b>45 78 55 721</b>	R/L ▲	207	216	233	293	326	349	378	416	-
		US	<b>50 78 55 721</b>	R/L ▲	208	217	235	294	329	357	389	428	-
		US	<b>60 78 55 721</b>	R/L ▲	236	252	270	337	373	398	437	481	-
<p>386 386</p>  <p><b>Sink carcass</b>                      2 doors consisting of                      2 panels 38.6 cm attached to 2 panels 38.6 cm                      1 inside panel                      1 aluminium protective shelf                      Left door with buffer strip                      Without centre panel</p>		US	<b>80 78 55 721</b>	▲	315	332	359	491	562	601	667	734	-
		US	<b>90 78 55 721</b>	▲	319	334	364	493	564	603	670	737	-
		US	<b>100 78 55 721</b>	▲	335	347	378	524	566	605	673	740	-
		US	<b>120 78 55 721</b>	▲	375	402	441	597	647	691	776	854	-
<p>126 256 386</p>  <p><b>Sink carcass</b>                      1 door consisting of                      1 panel 12.6 cm attached to 1 panel 25.6 cm and panel 38.6 cm                      1 inside panel                      1 aluminium protective shelf</p>		US	<b>40 78 55 731</b>	R/L ▲	205	215	231	292	325	347	377	415	-
		US	<b>45 78 55 731</b>	R/L ▲	207	216	233	293	326	349	378	416	-
		US	<b>50 78 55 731</b>	R/L ▲	208	217	235	294	329	357	389	428	-
		US	<b>60 78 55 731</b>	R/L ▲	236	252	270	337	373	398	437	481	-
<p>126 256 386</p>  <p><b>Sink carcass</b>                      2 doors consisting of                      2 panels 12.6 cm attached to 2 panels 25.6 cm and 2 panels 38.6 cm                      1 inside panel                      1 aluminium protective shelf                      Left door with buffer strip                      Without centre panel</p>		US	<b>80 78 55 731</b>	▲	315	332	359	491	562	601	667	734	-
		US	<b>90 78 55 731</b>	▲	319	334	364	493	564	603	670	737	-
		US	<b>100 78 55 731</b>	▲	335	347	378	524	566	605	673	740	-
		US	<b>120 78 55 731</b>	▲	375	402	441	597	647	691	776	854	-

## Base units 78 cm high for water purifying, boiling and chilling systems

Carcass depth 55.5 cm (standard)

□ = Models also available in 45.5/61 cm carcass depth (order no.: replace ... 55 ... with 45/61) ▲ = Types also available with 61 cm carcass depth (order no. ... replace ... 55 ... with 61)

<p>776</p>  <p><b>Base unit for purifying, boiling and chilling water</b>                      1 door 77.6 cm                      1 internal drawer with 1 Ambia-Line frame set for storing cartridges                      1 aluminium protective shelf</p>		UWS	<b>45 78 55 70</b>	R/L ▲	430	440	457	515	550	572	602	662	-
		UWS	<b>60 78 55 70</b>	R/L ▲	491	507	525	591	628	652	691	760	-
<p>Please follow the fitting instructions from the appliance manufacturers                      61 cm clear installed height and 50.5 cm clear installed height for water purifying, boiling and chilling systems</p>													
<p>776</p>  <p><b>Sink carcass for water treatment system</b>                      1 door 77.6 cm (29.6 cm wide)                      1 pull-out 77.6 cm (front 59.6 cm wide)                      1 inside panel with frame and waste bin for hanging Hailo Cargo Flex 1x 28 l, 2x 13 l</p>	<b>NEW</b>	US	<b>90 78 55 97</b>	R/L ▲	773	789	815	950	1019	1060	1124	1183	-
<p>776</p> 	<b>NEW</b>	US	<b>90 78 55 971</b>	R/L ▲	773	789	815	950	1019	1060	1124	1183	-
<p>126 256 386</p>  <p><b>Sink carcass ideal for incorporating into water purifier, boiling and chilling systems, like Quooker</b>                      2 doors consisting of                      2 panels 12.6 cm attached to 2 panels 25.6 cm and 2 panels 38.6 cm                      1 inside panel                      1 aluminium protective shelf                      Left door with buffer strip                      Without centre panel</p>		US	<b>90 78 55 731</b>	▲	319	334	364	493	564	603	670	737	-
<p>Optional accessories                      HW UTB Utensils box, e.g. for storing towels, cleaning cloths, etc. (for screwing on), anthracite HAS T 15 15 Hailo AS Tandem waste bin</p>													

# Base units 78 cm high for water purifying, boiling and chilling systems

Carcase depth 55.5 cm (standard)

□ = Models also available in 45.5/61 cm carcass depth (order no.: replace ... 55 ... with 45/61)  
 ▲ = Types also available with 61 cm carcass depth (order no. ... replace ... 55 ... with 61)

Order no.  
W H D

Hinge side: Carcass depth	Price groups								
	1	2	3	4	5	6	7	8	9
	107								
	54								



**Hailo AS Tandem waste bin**  
 Number of containers: 2  
 Volume: 2 x 15 l  
 Color: dark gray  
 suitable for units with  
 hinged doors from a width of 30 cm

**HAST 15 15**



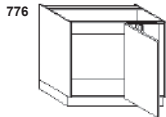
**Utensils box**  
 Utensils box, e.g. for storing  
 towels, cleaning cloths, etc.  
 (for screwing on), anthracite

**HW-UB**

## Corner base units Sink carcasses 78 cm high

Carcass depth 55.5 cm (standard)

□ = Models also available in 45.5/61 cm carcass depth (order no.: replace ... 55 ... with 45/61) ▲ = Types also available with 61 cm carcass depth (order no. ... replace ... 55 ... with 61)



Ill. right

**Corner sink base unit, variable**  
 Blind section left or right  
 1 inside panel  
 1 door 77.6 cm  
 Carcass width 100 cm with loose corner filler



**Note:**  
 Items in ALU TEC RP models  
 only available with a fixed corner angle min. dimensions 6 x 6 cm!  
 handle N700/775: with fixed corner angle

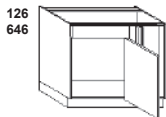
Door 40 cm  
 Door 45 cm  
 Door 50 cm  
 Door 60 cm

<b>USE 105 78 55 7</b>	R/L □	230	244	269	343	431	456	506	557	-
<b>USE 110 78 55 7</b>	R/L □	230	244	269	343	431	456	506	557	-
<b>USE 115 78 55 7</b>	R/L □	230	244	269	343	431	456	506	557	-
<b>USE 125 78 55 7</b>	R/L □	230	245	275	376	472	494	552	607	-

**Extra charge  
 for extending corner filler width**

**PLV**

24,20	25,10	25,10	34	34	34	34	37	-
-------	-------	-------	----	----	----	----	----	---



Ill. right

**Corner sink base unit, variable**  
 Blind section left or right  
 1 panel 12.6 cm  
 1 door 64.6 cm  
 Carcass width 100 cm with loose corner filler



**Note:**  
 Items in ALU TEC RP models  
 only available with a fixed corner angle min. dimensions 6 x 6 cm!  
 handle N700/775: with fixed corner angle

Door 40 cm  
 Door 45 cm  
 Door 50 cm  
 Door 60 cm

<b>USE 105 78 55 8</b>	R/L □	230	244	269	343	431	456	506	557	-
<b>USE 110 78 55 8</b>	R/L □	230	244	269	343	431	456	506	557	-
<b>USE 115 78 55 8</b>	R/L □	230	244	269	343	431	456	506	557	-
<b>USE 125 78 55 8</b>	R/L □	230	245	275	376	472	494	552	607	-

**Extra charge  
 for extending corner filler width**

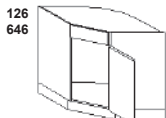
**PLV**

24,20	25,10	25,10	34	34	34	34	37	-
-------	-------	-------	----	----	----	----	----	---

## Diagonal corner base unit Sink carcasses 78 cm high

Carcass depth 55.5 cm (standard)

□ = Models also available in 45.5/61 cm carcass depth (order no.: replace ... 55 ... with 45/61)

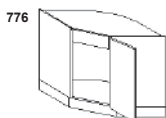


126  
646

**Diagonal sink base unit**  
 90 x 90 cm, inside depth 72.5 cm  
 1 panel 12.6 cm  
 1 door 40 cm wide, 64.6 cm high

<b>USD 90 78 80</b>	R/L	569	577	597	647	684	701	736	810	-
---------------------	-----	-----	-----	-----	-----	-----	-----	-----	-----	---

**Not available for:**  
 ALU TEC RP

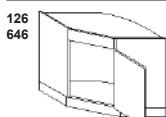


776

**Diagonal sink base unit**  
 90 x 90 cm, inside depth 72.5 cm  
 1 door 40 cm wide, 77.6 cm high  
 with 1 inside panel

<b>USD 90 78 70</b>	R/L	569	577	597	647	684	701	736	810	-
---------------------	-----	-----	-----	-----	-----	-----	-----	-----	-----	---

**Not available for:**  
 ALU TEC RP

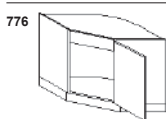


126  
646

**Diagonal sink base unit**  
 105 x 105 cm, inside depth 72.5 cm  
 1 panel 12.6 cm  
 1 door 60 cm wide, 64.6 cm high

<b>USD 105 78 80</b>	R/L	603	616	639	695	731	752	792	871	-
----------------------	-----	-----	-----	-----	-----	-----	-----	-----	-----	---

**Not available for:**  
 ALU TEC RP



776

**Diagonal sink base unit**  
 105 x 105 cm, inside depth 72.5 cm  
 1 door 60 cm wide, 77.6 cm high  
 with 1 inside panel


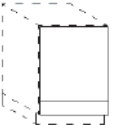
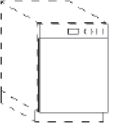
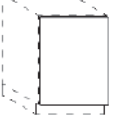

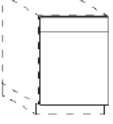
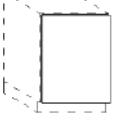
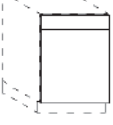
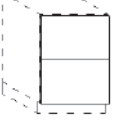
<b>USD 105 78 70</b>	R/L	603	616	639	695	731	752	792	871	-
----------------------	-----	-----	-----	-----	-----	-----	-----	-----	-----	---

**Not available for:**  
 ALU TEC RP

# Fronts for electrical appliances

Please specify the dishwasher item number when ordering.

Order no.  
W H D

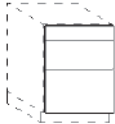
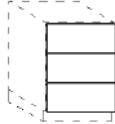
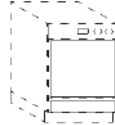
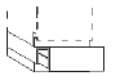

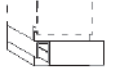






Hinge side:	Carcass depth	Price groups											
		1	2	3	4	5	6	7	8	9			
		<p><b>516</b> <b>126</b></p>  <p><b>Base unit door, 51.6 cm high with panel 12.6 cm at bottom, folding</b> as front panel for <b>integrated</b> dishwashers 82 cm high 44.6 cm wide with 45 cm 59.6 cm wide with 60 cm</p>	<p><b>UTVB 45 65</b></p>	187	191	196	209	277	294	330	363	-	
			<p><b>UTVB 60 65</b></p>	196	205	214	223	307	325	368	405	-	
		<p><b>646</b> <b>126</b></p>  <p><b>Base unit door, 64.6 cm high with panel 12.6 cm at bottom, folding</b> as front panel for <b>fully integrated</b> dishwashers 82 cm high 44.6 cm wide with 45 cm 59.6 cm wide with 60 cm</p>	<p><b>UTVB 45 78</b></p>	204	208	214	223	292	308	347	382	-	
			<p><b>UTVB 60 78</b></p>	214	218	228	236	322	340	381	419	-	
		<p><b>646</b></p>  <p><b>Base unit door, 64.6 cm</b> as front panel for integrated dishwashers 86 cm high 44.6 cm wide with 45 cm 59.6 cm wide with 60 cm</p>	<p><b>UT 45 65</b></p>	96	100	108	120	186	207	244	268	-	
			<p><b>UT 60 65 2</b></p>	108	112	122	134	218	236	281	309	-	
		<p><b>776</b></p>  <p><b>Base unit door, 77.6 cm</b> 59.6 cm wide As front panel for fully integrated dishwashers 86 cm high and pull-out fridges and freezers 44.6 cm wide with 45 cm 59.6 cm wide with 60 cm</p>	<p> <i>Always order article DL 60 6 if a high-volume dishwasher has not been included in planning!</i></p>										
			<p><b>UT 45 78 1</b></p>	111	116	122	134	204	220	257	283	-	
			<p><b>UT 60 78 1</b></p>	122	126	138	146	232	253	294	323	-	
		<p><b>126</b> <b>646</b></p>  <p><b>Base unit door, 77.6 cm</b> 1 drawer panel 12.6 cm with 1 door 64.6 cm connected As front panel for fully integrated dishwashers 86 cm high and pull-out fridges and freezers 44.6 cm wide with 45 cm <i>Surcharge in connection with the grip rails N700 and N775 incl. connecting plate and additional grip rails</i> 59.6 cm wide with 60 cm <i>Surcharge in connection with the grip rails N700 and N775 incl. connecting plate and additional grip rails</i></p>	<p><b>UTV 45 78</b></p>	111	116	122	134	204	220	257	283	-	
			<p><b>Extra charge for MP-GSN...</b></p>	145	145	145	145	145	145	145	145		
			<p><b>UTV 60 78</b></p>	122	126	138	146	232	253	294	323	-	
			<p><b>Extra charge for MP-GSN...</b></p>	148	148	148	148	148	148	148	148		
		<p><b>776</b></p>  <p><b>Base unit door, 77.6 cm high</b> for integrated built-under fridges with door and fully integrated washing machines 44.6 cm wide with 45 cm 59.6 cm wide with 60 cm</p>	<p><b>UT 45 78 11</b></p>	R/L	111	116	122	134	204	220	257	283	-
			<p><b>UT 60 78 11</b></p>	R/L	122	126	138	146	232	253	292	321	-
		<p><b>126</b> <b>646</b></p>  <p><b>Base unit door, 77.6 cm high</b> 1 drawer panel 12.6 cm with 1 door 64.6 cm connected for integrated built-under fridges with door and fully integrated washing machines 44.6 cm wide with 45 cm <i>Surcharge in connection with the grip rails N700 and N775 incl. connecting plate and additional grip rails</i> 59.6 cm wide with 60 cm <i>Surcharge in connection with the grip rails N700 and N775 incl. connecting plate and additional grip rails</i></p>	<p><b>UTV 45 78 1</b></p>	R/L	111	116	122	134	204	220	257	283	-
			<p><b>Extra charge for MP-GSN...</b></p>		145	145	145	145	145	145	145	145	
			<p><b>UTV 60 78 1</b></p>	R/L	122	126	138	146	232	253	294	323	-
			<p><b>Extra charge for MP-GSN...</b></p>		148	148	148	148	148	148	148	148	
		<p><b>386</b> <b>386</b></p>  <p><b>Base unit door, 77.6 cm</b> split into 2 connected panels with 38.6 cm each As front panel for fully integrated dishwashers 44.6 cm wide with 45 cm <i>Surcharge in connection with the grip rails N700 and N775 incl. connecting plate and additional grip rails</i> 59.6 cm wide with 60 cm <i>Surcharge in connection with the grip rails N700 and N775 incl. connecting plate and additional grip rails</i></p>	<p><b>UT 45 78 02</b></p>		138	143	154	169	254	275	321	353	-
			<p><b>Extra charge for MP-GSN...</b></p>		145	145	145	145	145	145	145	145	145
			<p><b>UT 60 78 02</b></p>		154	161	172	183	292	316	367	404	-
			<p><b>Extra charge for MP-GSN...</b></p>		148	148	148	148	148	148	148	148	



# Fronts for electrical appliances

Please specify the dishwasher item number when ordering.

Order no.  
W H D


Hinge side: Carcass depth	Price groups												
	1	2	3	4	5	6	7	8	9				
126 256 386	 <p><b>Base unit door, 77.6 cm</b> split into drawer panel 12.6 cm connected pull-out panels 25.6 cm and 38.6 cm As front panel for fully integrated dishwashers</p> <p>44.6 cm wide with 45 cm <i>Surcharge in connection with the grip rails N700 and N775 incl. connecting plate and additional grip rails</i></p> <p>59.6 cm wide with 60 cm <i>Surcharge in connection with the grip rails N700 and N775 incl. connecting plate and additional grip rails</i></p>												
		<b>UT 45 78 12</b>	147	154	164	180	271	295	345	380	-		
		<b>Extra charge for MP-GSN...</b>	261	261	261	261	261	261	261	261	261		
		<b>UT 60 78 12</b>	164	170	186	196	311	340	393	432	-		
		265	265	265	265	265	265	265	265				
256 256 256	 <p><b>Base unit door, 77.6 cm</b> split into 3 pull-out panels 25.6 cm As front panel for fully integrated dishwashers</p> <p>44.6 cm wide with 45 cm <i>Surcharge in connection with the grip rails N700 and N775 incl. connecting plate and additional grip rails</i></p> <p>59.6 cm wide with 60 cm <i>Surcharge in connection with the grip rails N700 and N775 incl. connecting plate and additional grip rails</i></p>												
		<b>UT 45 78 03</b>	147	154	164	180	271	295	345	380	-		
		<b>Extra charge for MP-GSN...</b>	261	261	261	261	261	261	261	261	261		
		<b>UT 60 78 03</b>	164	170	186	196	311	340	393	432	-		
		265	265	265	265	265	265	265	265				
 <p><b>Front decor panels</b> Price group 1 - 3: lamine in front decor or smooth lacquering Price group 4 - 7: smooth veneer, smooth lacquering or laminate</p>	per m <sup>2</sup> , W x H												
	<b>DP 00</b>	49	51	156	213	513	513	513	564	-			
	<b>minimum price</b>	24	25	77	107	257	257	257	283	-			
	<p><b>Note:</b> Price per m<sup>2</sup>, Minimum price: 0.5 m<sup>2</sup>  <b>Not available for:</b> TOP 1251/2/4; TOP 1256/7/9, TOP 1296-1309, TOP 1346-1364 TOP 1396/9, TOP 1421/4, TOP 1431/4, TOP 1441-1449, TOP 1486/9 TOP 1586-1589, TREND 1581-1584, TREND 1596-1599 SHERWOOD, PUR, EDITION, CASA-B, SIGNUM-B, MIAMI, FRAME, SMART, SMART-M, VILLAGE 15-S, VILLAGE 15-B, SOFIE-S, SOFIE-B, FENIX-INOX, SMART MIRROR, OSLO 15, LUGANO, TESSIN 15, BAVARIA, MONTANA, NEVADA; PADUA, MODENA, FLORENZ</p>												
256	 <p><b>Base for raised dishwasher (86 cm high)</b> with top shelf, 15.5 cm high 1 drawer with pull-out panel 25.6 cm, angled at top, 45.5 cm deep 1 collection tray (available only in 60 cm width)</p> <p>Overall height 104 cm Planning dimension 65 cm</p>	 <p><b>UGS 45 10 55 87</b></p> <p><b>UGS 60 10 55 87</b></p> <p><b>Not available for:</b> ALU TEC RP</p> <p><b>Important!</b> Plan free-standing with 25 mm panels</p>	▲	251	258	280	341	369	391	422	464	-	
			▲	276	290	320	378	412	439	480	528	-	
256	 <p><b>Base for raised dishwasher (86 cm high)</b> only for dishwashers with <b>VARIO HINGE</b> with top shelf, 15.5 cm high 1 drawer with pull-out panel 25.6 cm not angled 45.5 cm deep 1 collection tray (available only in 60 cm width)</p> <p>Overall height 104 cm Planning dimension 65 cm</p>	 <p><b>UGV 60 10 55 87</b></p> <p><b>Important!</b> Plan free-standing with 25 mm panels</p>	▲	276	290	320	378	412	439	480	528	-	
386	 <p><b>Base for raised dishwasher (86 cm high)</b> with top shelf, 28.5 cm high 1 pull-out 38.6 cm, angled at top, 45.5 cm deep 1 collection tray (available only in 60 cm width)</p> <p>Overall height 117 cm Planning dimension 65 cm</p>	 <p><b>UGS 45 11 55 87</b></p> <p><b>UGS 60 11 55 87</b></p> <p><b>Not available for:</b> ALU TEC RP</p> <p><b>Important!</b> Plan free-standing with 25 mm panels</p>	▲	258	263	290	352	375	399	430	473	-	
			▲	285	298	326	389	419	445	485	534	-	
386	 <p><b>Base for raised dishwasher (86 cm high)</b> only for dishwashers with <b>VARIO HINGE</b> with top shelf, 28.5 cm high 1 pull-out panel 38.6 cm, 45.5 cm deep not angled 1 collection tray (available only in 60 cm width)</p> <p>Overall height 117 cm Planning dimension 65 cm</p>	 <p><b>UGV 60 11 55 87</b></p> <p><b>Important!</b> Plan free-standing with 25 mm panels</p>	▲	285	298	326	389	419	445	485	534	-	
 <p><b>Height compensation panel for dishwashers</b> 1 stainless steel panel 6 cm high with screws for working height 92 cm for height compensation for fully integrated standard dishwashers</p>	<b>Z 51-45</b>	43											
	<b>Z 51-60</b>	43											

# Fronts for electrical appliances

Please specify the dishwasher item number when ordering.


Order no.  
W H D

Hinge side:	Carcase depth	Price groups								
		1	2	3	4	5	6	7	8	9
		32								
		82								
		74								
		806								
		808								
Note:		Only available in conjunction with fully integrated dishwasher in 82 cm height								




**Spacer strips for fully integrated dishwasher**  
Appliance height 82 cm  
2 spacer strips  
Colour: Art Pepper 6 cm high

<b>DL 60 6</b>										
----------------	--	--	--	--	--	--	--	--	--	--



**Plinth pedestal for fridges, dishwashers etc. for height compensation**  
With 15 cm and 20 cm plinth height (plinth feet with adapter)

<b>USO 60</b>										
<b>USO 45</b>										



**SERVO-DRIVE flex for dishwasher**  
55 cm deep  
1 inside panel removable  
1 fixed shelf for drive unit  
1 bottom shelf with preparation for SERVO-DRIVE flex Incl. drive unit and mains unit as well as SERVO-DRIVE switch and wireless receiver  
Cable length 160 m

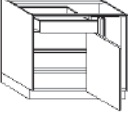
<b>SD-GSP45</b>										
<b>SD-GSP60</b>										

## Corner base units 78 cm high variable

Carcase depth 55,5 cm (standard)

■ = Models also available in 34/45,5/61 cm carcase depth (Order no.: ... replace ... 55 ... with 34/45/61) ▲ = Types also available with 61 cm carcase depth (order no. ... replace ... 55 ... with 61)

126  
646



**Corner base unit, variable**  
Blind section left or right  
1 drawer 12.6 cm  
1 door 64.6 cm  
2 adjustable shelves  
Carcase width 100 cm with loose corner filler

Ill. right

Door 40 cm  
Door 45 cm  
Door 50 cm  
Door 60 cm


Note:  
Items in ALU TEC RP models only available with a fixed corner angle min. dimensions 6 x 6 cm! handle N700/775: with fixed corner angle

<b>UE 105 78 55 10</b>	R/L ■	294	301	329	407	485	515	562	618	-
<b>UE 110 78 55 10</b>	R/L ■	294	301	329	407	485	515	562	618	-
<b>UE 115 78 55 10</b>	R/L ■	294	301	329	407	485	515	562	618	-
<b>UE 125 78 55 10</b>	R/L ■	294	302	331	439	526	554	607	668	-

**Extra charge for extending corner filler width**

<b>PLV</b>		24,20	25,10	25,10	34	34	34	34	37	-
------------	--	-------	-------	-------	----	----	----	----	----	---

776



**Corner base unit, variable**  
Blind section left or right  
1 door 77.6 cm  
2 adjustable shelves  
Carcase width 100 cm with loose corner filler

Ill. right

Door 40 cm  
Door 45 cm  
Door 50 cm  
Door 60 cm


Note:  
Items in ALU TEC RP models only available with a fixed corner angle min. dimensions 6 x 6 cm! handle N700/775: with fixed corner angle

<b>UE 105 78 55 70</b>	R/L ■	260	268	299	373	453	482	533	586	-
<b>UE 110 78 55 70</b>	R/L ■	260	268	299	373	453	482	533	586	-
<b>UE 115 78 55 70</b>	R/L ■	260	268	299	373	453	482	533	586	-
<b>UE 125 78 55 70</b>	R/L ■	260	269	301	409	493	523	577	635	-

**Extra charge for extending corner filler width**

<b>PLV</b>		24,20	25,10	25,10	34	34	34	34	37	-
------------	--	-------	-------	-------	----	----	----	----	----	---

386  
386



**Corner base unit, variable**  
Blind section left or right  
1 door consisting of 2 panels 38.6 cm attached  
2 adjustable shelves  
Carcase width 100 cm with loose full-width corner filler

Ill. right

Door 40 cm  
Door 45 cm  
Door 50 cm  
Door 60 cm

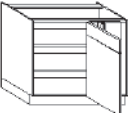
Note:  
Items in ALU TEC RP models only available with a fixed corner angle min. dimensions 6 x 6 cm! handle N700/775: with fixed corner angle

<b>UE 105 78 55 702</b>	R/L ■	305	314	345	419	498	528	579	637	-
<b>UE 110 78 55 702</b>	R/L ■	305	314	345	419	498	528	579	637	-
<b>UE 115 78 55 702</b>	R/L ■	305	314	345	419	498	528	579	637	-
<b>UE 125 78 55 702</b>	R/L ■	305	315	347	455	538	568	622	684	-

**Extra charge for extending corner filler width**

<b>PLV</b>		24,20	25,10	25,10	34	34	34	34	37	-
------------	--	-------	-------	-------	----	----	----	----	----	---

126  
646



**Corner base unit, variable**  
Blind section left or right  
1 panel 12.6 cm attached to 1 door 64.6 cm  
2 adjustable shelves  
Carcase width 100 cm with loose corner filler

Ill. right

Door 40 cm  
Door 45 cm  
Door 50 cm  
Door 60 cm

Note:  
Items in ALU TEC RP models only available with a fixed corner angle min. dimensions 6 x 6 cm! handle N700/775: with fixed corner angle

<b>UE 105 78 55 60</b>	R/L ■	260	268	299	373	453	482	533	586	-
<b>UE 110 78 55 60</b>	R/L ■	260	268	299	373	453	482	533	586	-
<b>UE 115 78 55 60</b>	R/L ■	260	268	299	373	453	482	533	586	-
<b>UE 125 78 55 60</b>	R/L ■	260	269	301	409	493	523	577	635	-

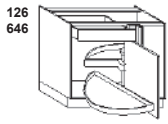
# Corner base units 78 cm high variable

Carcase depth 55.5 cm (standard)

■ = Models also available in 34/45/5/61 cm carcass depth (Order no.: ... replace ... 55 ... with 34/45/61)  
 ▲ = Types also available with 61 cm carcass depth (order no. ... replace ... 55 ... with 61)

Order no.  
W H D

Hinge side:	Carcass depth	Price groups										
		1	2	3	4	5	6	7	8	9		
		<b>PLV</b>	24,20	25,10	25,10	34	34	34	34	37	-	
		<b>Note:</b> Items in ALU TEC RP models only available with a fixed corner angle min. dimensions 6 x 6 cm! handle N700/775: with fixed corner angle										
		<b>UE 110 78 55 12</b>	R/L ▲	331	346	375	451	537	566	617	679	-
		<b>UE 115 78 55 12</b>	R/L ▲	331	346	375	451	537	566	617	679	-
		<b>UE 125 78 55 12</b>	R/L ▲	331	351	377	488	577	606	660	726	-
		<b>PLV</b>	24,20	25,10	25,10	34	34	34	34	37	-	
		<b>Note:</b> Items in ALU TEC RP models only available with a fixed corner angle min. dimensions 6 x 6 cm! handle N700/775: with fixed corner angle										
		<b>UE 110 78 55 71</b>	R/L ▲	301	316	343	423	506	536	583	641	-
		<b>UE 115 78 55 71</b>	R/L ▲	301	316	343	423	506	536	583	641	-
		<b>UE 125 78 55 71</b>	R/L ▲	301	320	346	460	546	573	628	691	-
		<b>PLV</b>	24,20	25,10	25,10	34	34	34	34	37	-	
		<b>Note:</b> Items in ALU TEC RP models only available with a fixed corner angle min. dimensions 6 x 6 cm! handle N700/775: with fixed corner angle										
		<b>UE 110 78 55 712</b>	R/L ▲	347	361	389	469	551	582	629	692	-
		<b>UE 115 78 55 712</b>	R/L ▲	347	361	389	469	551	582	629	692	-
		<b>UE 125 78 55 712</b>	R/L ▲	347	366	391	506	591	619	673	740	-
		<b>PLV</b>	24,20	25,10	25,10	34	34	34	34	37	-	
		<b>Note:</b> Items in ALU TEC RP models only available with a fixed corner angle min. dimensions 6 x 6 cm! handle N700/775: with fixed corner angle										
		<b>UE 110 78 55 61</b>	R/L ▲	301	316	343	423	506	536	583	641	-
		<b>UE 115 78 55 61</b>	R/L ▲	301	316	343	423	506	536	583	641	-
		<b>UE 125 78 55 61</b>	R/L ▲	301	320	346	460	546	573	628	691	-
		<b>PLV</b>	24,20	25,10	25,10	34	34	34	34	37	-	
		<b>Note:</b> Items in ALU TEC RP models only available with a fixed corner angle min. dimensions 6 x 6 cm! handle N700/775: with fixed corner angle										
		<b>UE 110 78 55 13</b>	R/L ▲	420	435	464	540	623	653	702	772	-
		<b>UE 115 78 55 13</b>	R/L ▲	420	435	464	540	623	653	702	772	-
		<b>UE 125 78 55 13</b>	R/L ▲	420	438	467	573	661	692	745	820	-
		<b>PLV</b>	24,20	25,10	25,10	34	34	34	34	37	-	

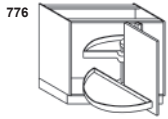


Ill. right

**Extra charge for extending corner filler width**

**Corner base unit, variable**  
 Blind section left or right  
 1 drawer 12.6 cm  
 1 door 64.6 cm  
 2 carousel shelves  
 Carcase width 100 cm with loose corner filler

Door 45 cm  
 Door 50 cm  
 Door 60 cm

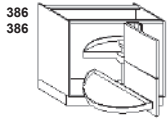


Ill. right

**Extra charge for extending corner filler width**

**Corner base unit, variable**  
 Blind section left or right  
 1 door 77.6 cm  
 2 carousel shelves  
 Carcase width 100 cm with loose corner filler

Door 45 cm  
 Door 50 cm  
 Door 60 cm

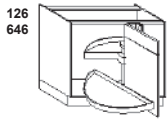


Ill. right

**Extra charge for extending corner filler width**

**Corner base unit, variable**  
 Blind section left or right  
 1 door consisting of  
 2 panels 38.6 cm attached  
 2 carousel shelves  
 Carcase width 100 cm with loose full-width corner filler

Door 45 cm  
 Door 50 cm  
 Door 60 cm

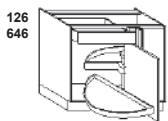


Ill. right

**Extra charge for extending corner filler width**

**Corner base unit, variable**  
 Blind section left or right  
 1 panel 12.6 cm attached to 1 door 64.6 cm  
 2 carousel shelves  
 Carcase width 100 cm with loose corner filler

Door 45 cm  
 Door 50 cm  
 Door 60 cm

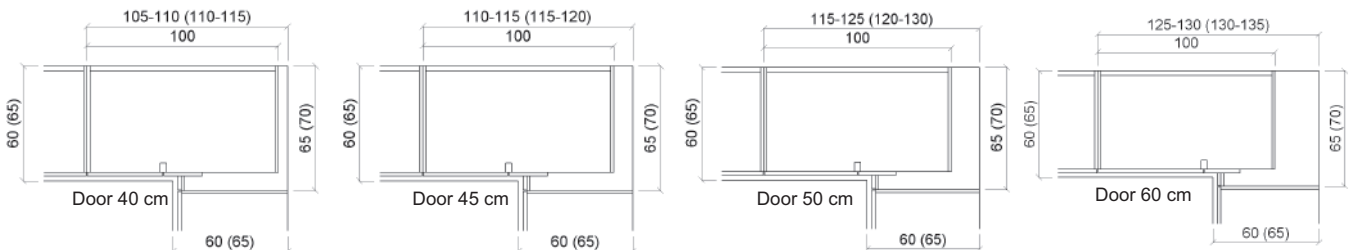


Ill. right

**Extra charge for extending corner filler width**

**Corner base unit, variable**  
 Blind section left or right  
 1 drawer 12.6 cm  
 1 door 64.6 cm  
 2 wooden carousel shelves with chrome-plated rail  
 Carcase width 100 cm With loose corner filler

Door 45 cm  
 Door 50 cm  
 Door 60 cm





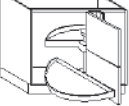

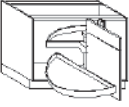

# Corner base units 78 cm high variable

Carcase depth 55.5 cm (standard)

■ = Models also available in 34/45.5/61 cm carcass depth (Order no.: ... replace ... 55 ... with 34/45/61)  
 ▲ = Types also available with 61 cm carcass depth (order no. ... replace ... 55 ... with 61)

Order no.  
W H D

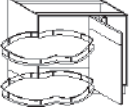

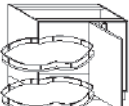

Hinge side:	Carcass depth	Price groups								
		1	2	3	4	5	6	7	8	9

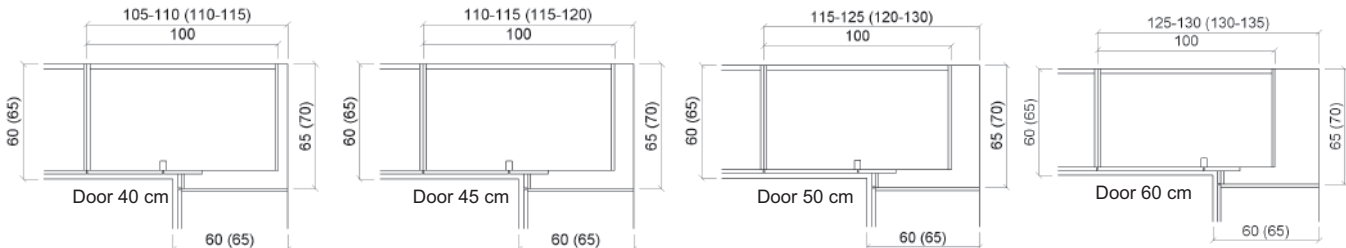
<p>776 </p> <p><b>Corner base unit, variable</b>                      Blind section left or right                      1 door 77.6 cm high                      2 wooden carousel shelves with chrome-plated rail                      Carcase width 100 cm with loose corner filler                      Door 45 cm                      Door 50 cm                      Door 60 cm</p> <p><i>Ill. right</i></p>	<p><b>Note:</b>   Items in ALU TEC RP models only available with a fixed corner angle min. dimensions 6 x 6 cm! handle N700/775: with fixed corner angle</p>	UE 110 78 55 73	R/L ▲	389	407	432	508	595	622	669	736	-
		UE 115 78 55 73	R/L ▲	389	407	432	508	595	622	669	736	-
		UE 125 78 55 73	R/L ▲	389	409	435	546	629	660	716	788	-
		PLV		24,20	25,10	25,10	34	34	34	34	37	-
<p>386 </p> <p><b>Corner base unit, variable</b>                      Blind section left or right                      1 door consisting of                      2 panels 38.6 cm attached                      2 wooden carousel shelves with chrome-plated rail. Carcase width 100 cm with loose full-width corner filler                      Door 45 cm                      Door 50 cm                      Door 60 cm</p> <p><i>Ill. right</i></p>	<p><b>Note:</b>   Items in ALU TEC RP models only available with a fixed corner angle min. dimensions 6 x 6 cm! handle N700/775: with fixed corner angle</p>	UE 110 78 55 732	R/L ▲	435	453	478	553	640	668	714	785	-
		UE 115 78 55 732	R/L ▲	435	453	478	553	640	668	714	785	-
		UE 125 78 55 732	R/L ▲	435	455	480	591	674	706	761	837	-
		PLV		24,20	25,10	25,10	34	34	34	34	37	-
<p>126 </p> <p>646</p> <p><b>Corner base unit, variable</b>                      Blind section left or right                      1 panel 12.6 cm attached to 1 door 64.6 cm                      2 wooden carousel shelves with chrome-plated rail                      Carcase width 100 cm with loose corner filler                      Door 45 cm                      Door 50 cm                      Door 60 cm</p> <p><i>Ill. right</i></p>	<p><b>Note:</b>   Items in ALU TEC RP models only available with a fixed corner angle min. dimensions 6 x 6 cm! handle N700/775: with fixed corner angle</p>	UE 110 78 55 63	R/L ▲	389	407	432	508	595	622	669	736	-
		UE 115 78 55 63	R/L ▲	389	407	432	508	595	622	669	736	-
		UE 125 78 55 63	R/L ▲	389	409	435	546	629	660	716	788	-
		PLV		24,20	25,10	25,10	34	34	34	34	37	-

# Corner base units 78 cm high Le Mans

Carcass depth 55.5 cm (standard)

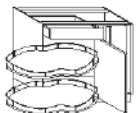
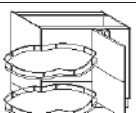

▲ = Types also available with 61 cm carcass depth (order no. ... replace ... 55 ... with 61)

<p>126 </p> <p>646</p> <p><b>Corner base unit „Le Mans“</b>                      Blind section left or right                      1 panel 12.6 cm attached to                      1 door 64.6 cm connected                      2 wooden carousel shelves with chrome-plated rail                      fully swivelling „Le Mans“                      Carcase width 100 cm with loose corner filler                      Door 45 cm                      Door 50 cm                      Door 60 cm</p> <p><i>Ill. right</i></p>	<p><b>Note:</b>   Please allow for shelf turning space and 50 cm clearance for carousel shelves. Items in ALU TEC RP models only available with a fixed corner angle min. dimensions 6 x 6 cm! handle N700/775: with fixed corner angle</p>	UE 110 78 55 64	R/L ▲	900	907	936	997	1082	1107	1156	1272	-
		UE 115 78 55 64	R/L ▲	935	944	973	1034	1114	1140	1190	1309	-
		UE 125 78 55 64	R/L ▲	982	991	1022	1112	1198	1227	1279	1407	-
		PLV		24,20	25,10	25,10	34	34	34	34	37	-
<p>776 </p> <p><b>Corner base unit „Le Mans“</b>                      Blind section left or right                      1 door 77.6 cm                      2 wooden carousel shelves with chrome-plated rail                      fully swivelling „Le Mans“                      Carcase width 100 cm with loose corner filler                      Door 45 cm                      Door 50 cm                      Door 60 cm</p> <p><i>Ill. right</i></p>	<p><b>Note:</b>   Please allow for shelf turning space and 50 cm clearance for carousel shelves. Items in ALU TEC RP models only available with a fixed corner angle min. dimensions 6 x 6 cm! handle N700/775: with fixed corner angle</p>	UE 110 78 55 74	R/L ▲	900	907	936	997	1082	1107	1156	1272	-
		UE 115 78 55 74	R/L ▲	935	944	973	1034	1114	1140	1190	1309	-
		UE 125 78 55 74	R/L ▲	982	991	1022	1112	1198	1227	1279	1407	-
		PLV		24,20	25,10	25,10	34	34	34	34	37	-



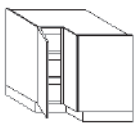
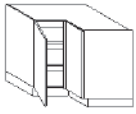
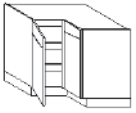
# Corner base units 78 cm high Le Mans

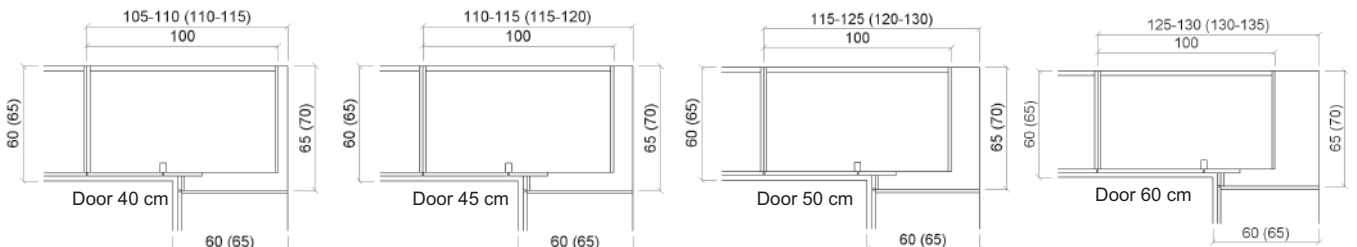
Carcase depth 55.5 cm (standard)

		Price groups										
		1	2	3	4	5	6	7	8	9		
Order no.	W H D											
Hinge side:	Carcase depth											
<b>Extra charge for extending corner filler width</b>		PLV	24,20	25,10	25,10	34	34	34	34	37	-	
 <p>126 646</p> <p><b>Corner base unit „Le Mans“</b> Blind section left or right 1 drawer 12.6 cm, 1 door 64.6 cm 2 wooden carousel shelves with chrome-plated rail fully swivelling „Le Mans“ Carcase width 100 cm with loose corner filler Door 45 cm Door 50 cm Door 60 cm</p> <p>ill. right</p>	<p><b>Note:</b> Please allow for shelf turning space and 50 cm clearance for carousel shelves. Items in ALU TEC RP models only available with a fixed corner angle min. dimensions 6 x 6 cm! handle N700/775: with fixed corner angle</p>											
	UE	110 78 55 14	R/L ▲	931	940	970	1031	1110	1137	1188	1307	-
	UE	115 78 55 14	R/L ▲	968	975	1004	1065	1145	1174	1223	1345	-
	UE	125 78 55 14	R/L ▲	1015	1024	1056	1144	1230	1258	1312	1443	-
<b>Extra charge for extending corner filler width</b>		PLV	24,20	25,10	25,10	34	34	34	34	37	-	
 <p>386 386</p> <p><b>Corner base unit „Le Mans“</b> Blind section left or right 1 door consisting of 2 panels 38.6 cm attached 2 wooden carousel shelves with chrome-plated rail fully swivelling „Le Mans“ Carcase width 100 cm with loose corner filler Door 45 cm Door 50 cm Door 60 cm</p> <p>ill. right</p>	<p><b>Note:</b> Please allow for shelf turning space and 50 cm clearance for carousel shelves. Items in ALU TEC RP models only available with a fixed corner angle min. dimensions 6 x 6 cm! handle N700/775: with fixed corner angle</p>											
	UE	110 78 55 742	R/L ▲	900	907	936	997	1082	1107	1156	1272	-
	UE	115 78 55 742	R/L ▲	935	944	973	1034	1114	1140	1190	1309	-
	UE	125 78 55 742	R/L ▲	982	991	1022	1112	1198	1227	1279	1407	-
 <p><b>Cushioned self-closing mechanism for „Le Mans“ carousel shelves</b></p>	<p><b>Important!</b> Version L = left suitable for unit types in the version L=left Version R = right suitable for unit types in the version R=right</p>											
	Z	142	R/L	41								

# Corner base units 78 cm high as carousel corner unit

Carcase depth 55.5 cm (standard)

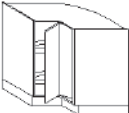


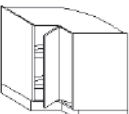


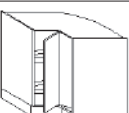


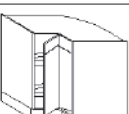


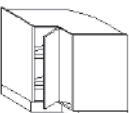


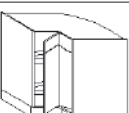


 <p>776</p> <p><b>Corner base unit with shelves</b> side length 80 x 80 cm 2 adjustable shelves 2 doors 20 cm wide, 77.6 cm high (doors attached to front panels not possible) Right door with corner angle 4.2 cm x 4.2 cm</p>	<p><b>PTO</b></p> <p><b>UEB 80 78 70</b></p> <p><b>Not available for:</b> ALU TEC RP</p> <p><b>Models:</b> FRAME, VILLAGE 15-S, VILLAGE 15-B, OSLO 15, TESSIN 15, BERGEN, LUGANO, CASTELLO, VIVA, VINO, TIM 15 are supplied with smooth fronts.</p>	565	583	637	710	710	727	792	871	-
 <p>776</p> <p><b>Corner base unit with shelves</b> side length 90 x 90 cm 2 adjustable shelves 2 doors 30 cm wide, 77.6 cm high (doors attached to front panels not possible) Right door with corner angle 4.2 cm x 4.2 cm</p>	<p><b>PTO</b></p> <p><b>UEB 90 78 70</b></p> <p><b>Not available for:</b> ALU TEC RP</p>	565	583	637	710	710	727	792	871	-
 <p>126 646</p> <p><b>Corner base unit with shelves</b> side length 90 x 90 cm 2 adjustable shelves 2 panels 12.6 cm with 2 doors 64.6 cm 30 cm wide Right door with corner angle 4.2 cm x 4.2 cm</p>	<p><b>PTO</b></p> <p><b>UEB 90 78 60</b></p> <p><b>Not available for:</b> ALU TEC RP</p>	565	583	637	710	710	727	792	871	-





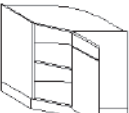

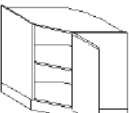

# Corner base units 78 cm high as carousel corner unit

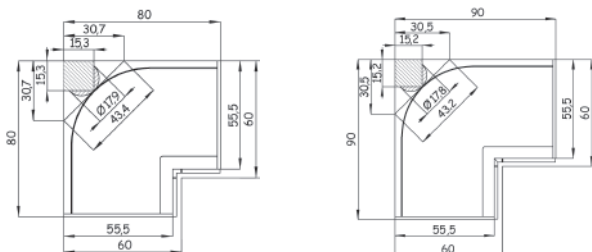
Carcase depth 55.5 cm (standard)

		Order no.		Hinge side:		Price groups									
		W H D		Carcase depth		1	2	3	4	5	6	7	8	9	
776	 <p><b>Corner base unit as carousel corner unit</b> side length 80 x 80 cm 2 wooden carousel shelves with chrome-plated rail with 360° rotation mechanism 2 doors 20 cm wide, 77.6 cm high (doors attached to front panels not possible) Right door with corner angle 4.2 x 4.2 cm</p>	<b>PTO</b>	<b>UEK 80 78 73</b>			754	774	826	898	898	913	976	1074	-	
			 <b>Not available for:</b> ALU TEC RP, MPX												
			 <b>Model ALU TEC RP:</b> The doors are different for technical reasons: left door 21.8 cm, right door 24.1 cm without corner angle, with handle N700/775, left door 21.8 cm, right door 24.1 cm without corner angle. width 20 cm: FRAME, VILLAGE 15-S, VILLAGE 15-B, CHALET-S, CHALET-B, OSLO 15, TESSIN 15, BERGEN, LUGANO, CASTELLO, VIVA, TIM 15 are supplied with smooth fronts.												
776	 <p><b>Corner base unit as carousel corner unit</b> side length 80 x 80 cm 2 carousel shelves with 360° rotation mechanism 2 doors 20 cm wide, 77.6 cm high (doors attached to front panels not possible) Right door with corner angle 4.2 x 4.2 cm</p>	<b>PTO</b>	<b>UEK 80 78 72</b>			565	583	637	710	710	727	792	871	-	
			 <b>Not available for:</b> ALU TEC RP, MPX												
			 <b>Model ALU TEC RP:</b> The doors are different for technical reasons: left door 21.8 cm, right door 24.1 cm without corner angle, with handle N700/775, left door 21.8 cm, right door 24.1 cm without corner angle. width 20 cm: FRAME, VILLAGE 15-S, VILLAGE 15-B, CHALET-S, CHALET-B, OSLO 15, TESSIN 15, BERGEN, LUGANO, CASTELLO, VIVA, TIM 15 are supplied with smooth fronts.												
776	 <p><b>Corner base unit as carousel corner unit</b> side length 90 x 90 cm 2 wooden carousel shelves with chrome-plated rail with 360° rotation mechanism 2 doors 30 cm wide, 77.6 cm high Right door with corner angle 4.2 x 4.2 cm</p>	<b>PTO</b>	<b>UEK 90 78 73</b>			754	774	826	898	898	913	976	1074	-	
			 <b>Not available for:</b> ALU TEC RP, MPX												
			 <b>Model ALU TEC RP:</b> The doors are different for technical reasons: left door 31.8 cm, right door 34.1 cm without corner angle, with handle N700/775, left door 31.8 cm, right door 34.1 cm without corner angle.												
126 646	 <p><b>Corner base unit as carousel corner unit</b> side length 90 x 90 cm 2 wooden carousel shelves with chrome-plated rail with 360° rotation mechanism 2 panels 12.6 cm with 2 doors 64.6 cm 30 cm wide Right door with corner angle 4.2 x 4.2 cm</p>	<b>PTO</b>	<b>UEK 90 78 63</b>			754	774	826	898	898	913	976	1074	-	
			 <b>Not available for:</b> ALU TEC RP												
			 <b>Not available for:</b> N700, N775												
776	 <p><b>Corner base unit as carousel corner unit</b> side length 90 x 90 cm 2 carousel shelves with 360° rotation mechanism 2 doors 30 cm wide, 77.6 cm high Right door with corner angle 4.2 cm x 4.2 cm</p>	<b>PTO</b>	<b>UEK 90 78 72</b>			565	583	637	710	710	727	792	871	-	
			 <b>Not available for:</b> ALU TEC RP, MPX												
			 <b>Model ALU TEC RP:</b> The doors are different for technical reasons: left door 31.8 cm, right door 34.1 cm without corner angle, with handle N700/775, left door 31.8 cm, right door 34.1 cm without corner angle.												
126 646	 <p><b>Corner base unit as carousel corner unit</b> side length 90 x 90 cm 2 carousel shelves with 360° rotation mechanism Panel 12.6 cm with doors 64.6 cm attached 30 cm wide Right door with corner angle 4.2 cm x 4.2 cm</p>	<b>PTO</b>	<b>UEK 90 78 62</b>			565	583	637	710	710	727	792	871	-	
			 <b>Not available for:</b> ALU TEC RP												
			 <b>Not available for:</b> N700, N775												

## Diagonal corner base unit 78 cm high

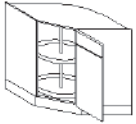

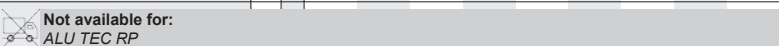
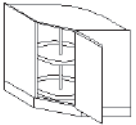


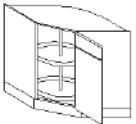

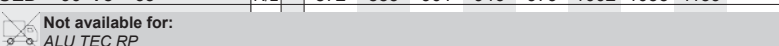
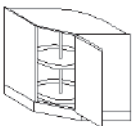


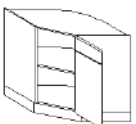


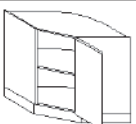

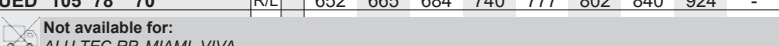
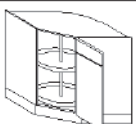

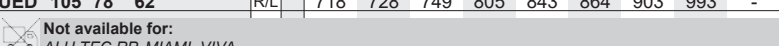
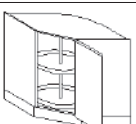

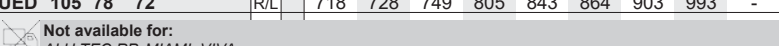
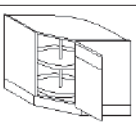

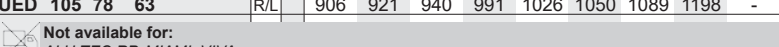
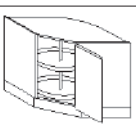

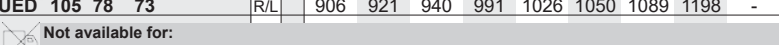
Carcase depth 55.5 cm (standard)

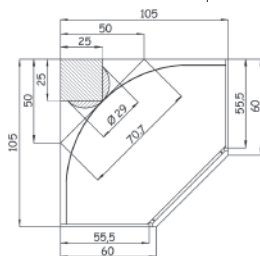
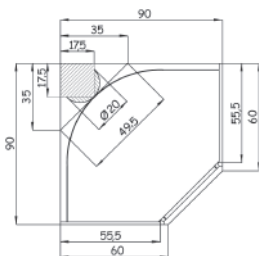
126 646	 <p><b>Diagonal corner base unit</b> 90 x 90 cm, inside depth 72.5 cm 1 panel 12.6 cm attached to 1 door 64.6 cm connected 40 cm wide 1 adjustable shelf</p>	<b>PTO</b>	<b>UED 90 78 60</b>	R/L	620	630	644	697	732	750	784	862	-
			 <b>Not available for:</b> ALU TEC RP										
776	 <p><b>Diagonal corner base unit</b> 90 x 90 cm, inside depth 72.5 cm 1 door 40 cm wide, 77.6 cm high 1 adjustable shelf</p>	<b>PTO</b>	<b>UED 90 78 70</b>	R/L	620	630	644	697	732	750	784	862	-
			 <b>Not available for:</b> ALU TEC RP										



# Diagonal corner base unit 78 cm high

Carcase depth 55.5 cm (standard)

		Order no.		Hinge side:	Carcase depth	Price groups									
		W	H			D	1	2	3	4	5	6	7	8	9
126 646		<b>Diagonal carousel corner base unit</b> 90 x 90 cm, inside depth 72.5 cm 1 panel 12.6 cm attached to 1 door 64.6 cm connected 40 cm wide 2 carousel shelves			<b>UED 90 78 62</b>	R/L	684	693	712	760	796	814	850	935	-
															
776		<b>Diagonal carousel corner base unit</b> 90 x 90 cm, inside depth 72.5 cm 1 door 40 cm wide, 77.6 cm high 2 carousel shelves			<b>UED 90 78 72</b>	R/L	684	693	712	760	796	814	850	935	-
															
126 646		<b>Diagonal carousel corner base unit</b> 90 x 90 cm, inside depth 72.5 cm 1 panel 12.6 cm attached to 1 door 64.6 cm connected 40 cm wide 2 wooden carousel shelves with chrome-plated rail			<b>UED 90 78 63</b>	R/L	872	885	901	946	979	1002	1035	1139	-
															
776		<b>Diagonal carousel corner base unit</b> 90 x 90 cm, inside depth 72.5 cm 1 door 40 cm wide, 77.6 cm high 2 wooden carousel shelves with chrome-plated rail			<b>UED 90 78 73</b>	R/L	872	885	901	946	979	1002	1035	1139	-
															
126 646		<b>Diagonal corner base unit</b> 105 x 105 cm, inside depth 72.5 cm 1 panel 12.6 cm attached to 1 door 64.6 cm connected 60 cm wide 1 adjustable shelf			<b>UED 105 78 60</b>	R/L	652	665	684	740	777	802	840	924	-
															
776		<b>Diagonal corner base unit</b> 105 x 105 cm, inside depth 72.5 cm 1 door 60 cm wide, 77.6 cm high 1 adjustable shelf			<b>UED 105 78 70</b>	R/L	652	665	684	740	777	802	840	924	-
															
126 646		<b>Diagonal carousel corner base unit</b> 105 x 105 cm, inside depth 72.5 cm 1 panel 12.6 cm attached to 1 door 64.6 cm connected 60 cm wide 2 carousel shelves			<b>UED 105 78 62</b>	R/L	718	728	749	805	843	864	903	993	-
															
776		<b>Diagonal carousel corner base unit</b> 105 x 105 cm, inside depth 72.5 cm 1 door 60 cm wide, 77.6 cm high 2 carousel shelves			<b>UED 105 78 72</b>	R/L	718	728	749	805	843	864	903	993	-
															
126 646		<b>Diagonal carousel corner base unit</b> 105 x 105 cm, inside depth 72.5 cm 1 panel 12.6 cm attached to 1 door 64.6 cm connected 60 cm wide 2 wooden carousel shelves with chrome-plated rail			<b>UED 105 78 63</b>	R/L	906	921	940	991	1026	1050	1089	1198	-
															
776		<b>Diagonal carousel corner base unit</b> 105 x 105 cm, inside depth 72.5 cm 1 door 60 cm wide, 77.6 cm high 2 wooden carousel shelves with chrome-plated rail			<b>UED 105 78 73</b>	R/L	906	921	940	991	1026	1050	1089	1198	-
															





# Base shelf units 78 cm high

Carcase depth 57.7 cm, flush with front

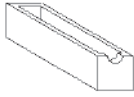
- = Models also available in 36.1/47.7/63.2 cm carcass depth (Order no.: replace ... 58 ... with 36/48/63)
- = Models also available in 47.7 cm carcass depth (order no.: replace ... 58 ... with 48)
- ▲ = Types also available with 63.2 cm carcass depth (order no. ... replace ... 58 ... with 63)

Order no.  
W H D

Hinge side:	Carcass depth	Decor groups										
		M10	M20	M30	M40	M50	M60	M70	M80	M90		
■	36.1 47.7 57.7 63.2	UR	30 78 58	207	-	-	-	761	-	761	761	-
			40 78 58	207	-	-	-	761	-	761	761	-
			45 78 58	207	-	-	-	761	-	761	761	-
			50 78 58	207	-	-	-	761	-	761	761	-
			60 78 58	207	-	-	-	761	-	761	761	-
			80 78 58	234	-	-	-	823	-	1057	1057	-
			90 78 58	234	-	-	-	823	-	1057	1057	-
			URFL	15 78 58	224	-	-	-	655	-	655	655
□	URFL	30 78 58	341	-	-	-	835	-	835	835	-	
▲	■	URH	15 78 58	252	-	-	-	754	-	754	754	-
			20 78 58	252	-	-	-	754	-	754	754	-
			25 78 58	252	-	-	-	754	-	754	754	-
R/L	■	URS	00 78 58	278	-	-	-	1075	-	1075	1075	-
<b>Important!</b> Please state right and left carcass depth (minimum depth 10 cm)												
R/L	■	URS	25 78 58	240	-	-	-	721	-	721	721	-
<b>Note:</b> Only available in 25 cm width. Worktop length 27.5 cm												
R/L	■	URA	25 78 58	211	-	-	-	588	-	588	588	-
<b>Note:</b> Only available in 25 cm width. Worktop length 27.3 cm												
R/L	■	URA	34 78 58	211	-	-	-	687	-	687	687	-
<b>Note:</b> Worktop length 36.3 cm												
□	URSK	15 78 58	224	-	-	-	655	-	655	655	-	

M 10	M 20	M 30	M 40	M 50
K M10 laminate				B M50 Velvet lacquer S M50 microstructure lacquer
M 60	M 70	M 80	M 90	
	F M70 veneer / oak / walnut Z M70 Veneer / Bavaria	H M80 high gloss-Lacquer MP M80 laqué mat Premium		







# Container

				Decor groups														
				M10	M20	M30	M40	M50	M60	M70	M80	M90						
 <p><b>Container</b> 11 cm high, for 15 cm wide base shelf unit</p>				Order no. W H D		Hinge side: Carcase depth		SKU 15 13		-	-	-	-	161	-	161	-	-
M 10		M 20		M 30		M 40		M 50		B M50 Velvet Lacquer S M50 Microstructure Lacquer								
M 60		M 70		M 80		M 90												
		F M70 veneer / oak / walnut																

# Base shelf units 78 cm high

Carcase depth 57.7 cm, flush with front

■ == Models also available in 36.1/47.7/63.2 cm carcass depth  
(Order no.: replace ... 58 ... with 36/48/63)

				Price groups															
				1	2	3	4	5	6	7	8	9							
 <p><b>Base shelf unit 45 cm</b> 3 pull-outs with inset front</p>				Order no. W H D		Hinge side: Carcase depth		URIF 45 78 58 IA3K		■	748	762	802	890	999	1090	1128	1241	-
								URIF 45 78 58 IA3B		■	1302	1317	1357	1444	1553	1644	1682	1850	-
								URIF 45 78 58 IA3F		■	1302	1317	1357	1444	1553	1644	1682	1850	-
								URIF 45 78 58 IA3S		■	1302	1317	1357	1444	1553	1644	1682	1850	-
								URIF 45 78 58 IA3Z		■	1302	1317	1357	1444	1553	1644	1682	1850	-
 <p><b>Base shelf unit 60 cm</b> 3 pull-outs with inset front</p>								URIF 60 78 58 IA3K		■	785	809	853	944	1077	1144	1199	1319	-
								URIF 60 78 58 IA3B		■	1340	1363	1408	1499	1630	1698	1753	1928	-
								URIF 60 78 58 IA3S		■	1340	1363	1408	1499	1630	1698	1753	1928	-
								URIF 60 78 58 IA3F		■	1340	1363	1408	1499	1630	1698	1753	1928	-
								URIF 60 78 58 IA3Z		■	1340	1363	1408	1499	1630	1698	1753	1928	-
 <p><b>Base shelf unit 90 cm</b> 3 pull-outs with inset front</p>								URIF 90 78 58 IA3K		■	976	1071	1081	1183	1345	1458	1514	1665	-
								URIF 90 78 58 IA3B		■	1564	1659	1668	1769	1931	2044	2102	2312	-
								URIF 90 78 58 IA3F		■	1564	1659	1668	1769	1931	2044	2102	2312	-
								URIF 90 78 58 IA3S		■	1564	1659	1668	1769	1931	2044	2102	2312	-
								URIF 90 78 58 IA3Z		■	1564	1659	1668	1769	1931	2044	2102	2312	-
 <p><b>Base shelf unit 45 cm</b> 4 drawers with inset front</p>								URIF 45 78 58 IS4K		■	739	744	754	856	974	996	1034	1137	-
								URIF 45 78 58 IS4B		■	1293	1297	1307	1411	1529	1551	1587	1746	-
								URIF 45 78 58 IS4F		■	1293	1297	1307	1411	1529	1551	1587	1746	-
								URIF 45 78 58 IS4S		■	1293	1297	1307	1411	1529	1551	1587	1746	-
								URIF 45 78 58 IS4Z		■	1293	1297	1307	1411	1529	1551	1587	1746	-
 <p><b>Base shelf unit 60 cm</b> 4 drawers with inset front</p>								URIF 60 78 58 IS4K		■	766	771	789	902	1024	1082	1132	1245	-
								URIF 60 78 58 IS4B		■	1321	1325	1343	1456	1577	1637	1686	1855	-
								URIF 60 78 58 IS4F		■	1321	1325	1343	1456	1577	1637	1686	1855	-
								URIF 60 78 58 IS4S		■	1321	1325	1343	1456	1577	1637	1686	1855	-
								URIF 60 78 58 IS4Z		■	1321	1325	1343	1456	1577	1637	1686	1855	-
 <p><b>Base shelf unit 90 cm</b> 4 drawers with inset front</p>								URIF 90 78 58 IS4K		■	903	925	939	1079	1209	1291	1349	1484	-
								URIF 90 78 58 IS4B		■	1489	1512	1526	1666	1797	1878	1937	2131	-
								URIF 90 78 58 IS4F		■	1489	1512	1526	1666	1797	1878	1937	2131	-
								URIF 90 78 58 IS4S		■	1489	1512	1526	1666	1797	1878	1937	2131	-
								URIF 90 78 58 IS4Z		■	1489	1512	1526	1666	1797	1878	1937	2131	-
										Not available for: ALU TEC RP, ALUELEMENTS, ATLANTA-B, ATLANTA-S, BERGEN, CASTELLO, CHALET-B, CHALET-S, CHICAGO, FRAME, GENT, INTARSIA, LUGANO, LUX-B, MIAMI, NOBEL-B, NOBEL-S, OPAL-H, ORLANDO-B, ORLANDO-S, OSLO 15, PALERMO-B, PALERMO-S, ROMA-B, ROMA-S, SOFIE-B, SOFIE-S, STRIP ELEMENTS, TALEA, TESSIN 15, TIM 15, VILLAGE 15-B, VILLAGE 15-S, VINO, VIVA, YORK-B, YORK-S									
M 10		M 20		M 30		M 40		M 50		B M50 Velvet Lacquer S M50 Microstructure Lacquer									
M 60		M 70		M 80		M 90													
		F M70 veneer / oak / walnut Z M70 Veneer / Bavaria																	

■ = extra charge for wall-mounted units, item: MP-WST

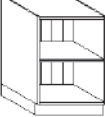
# Base shelf units 78 cm high, country house elements

fixed shelves 25 mm with profile at top and bottom  
Carcase depth 57.7 cm, flush with front

▲ = Types also available with 63.2 cm carcass depth (order no. ... replace ... 58 ... with 63)

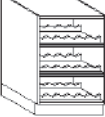
Order no.  
W H D

Hinge side:	Carcass depth	Decor groups										
		M10	M20	M30	M40	M50	M60	M70	M80	M90		
		<b>Note:</b> Usable inside depth 33.4 cm!										
		<b>URL 30 78 58</b>	▲	-	-	-	-	701	-	-	-	-
		<b>URL 45 78 58</b>	▲	-	-	-	-	824	-	-	-	-
		<b>URL 60 78 58</b>	▲	-	-	-	-	947	-	-	-	-
		<b>URL 90 78 58</b>	▲	-	-	-	-	1195	-	-	-	-
		<b>Note:</b> Usable inside depth 33.4 cm!										
		<b>URFLL30 78 58</b>	▲	-	-	-	-	1020	-	-	-	-
		<b>URFLL45 78 58</b>	▲	-	-	-	-	1306	-	-	-	-
		<b>URFLL60 78 58</b>	▲	-	-	-	-	1632	-	-	-	-
		<b>URAL 40 78 58</b>	R/L ▲	-	-	-	-	986	-	-	-	-
		<b>URAL 94 78 35</b>		-	-	-	-	1166	-	-	-	-
		<b>Note:</b> For carcass depths 55.5 cm and 34 cm										
		<b>URAL 11 78 35</b>		-	-	-	-	1229	-	-	-	-
		<b>Note:</b> For carcass depths 55.5 cm and 45.5 cm										
		<b>URAL 12 78 35</b>		-	-	-	-	1307	-	-	-	-
		<b>Note:</b> For carcass depths 55.5 cm and 55.5 cm										




**Base shelf unit**  
Grooved back panel  
Carcass depth 57.7 cm  
Flush with front  
1 fixed shelf

wide in cm: 30  
wide in cm: 45  
wide in cm: 60  
wide in cm: 90



**Base unit bottle shelf**  
Carcass depth 57.7 cm  
Flush with front  
Back panel grooved and set forward  
3 partitions with bottle holder

30 cm: max. 9 bottles  
45 cm: max. 12 bottles  
60 cm: max. 18 bottles



**Base shelf end unit**  
**With 1 pilaster at front with frieze**  
width 40 cm  
Carcass depth 57.7 cm  
Flush with front  
Grooved back panel and side panel  
1 fixed shelf



**Base shelf end unit**  
**for island solutions**  
**With pilaster with frieze**  
width 35 cm, depth 93.8 cm  
grooved side panel  
1 fixed shelf



**Base shelf end unit**  
**for island solutions**  
**With pilaster with frieze**  
width 35 cm, depth 105.4 cm  
grooved side panel  
1 fixed shelf



**Base shelf end unit**  
**for island solutions**  
**With pilaster with frieze**  
width 35 cm, depth 115.4 cm  
grooved side panel  
1 fixed shelf

M 10	M 20	M 30	M 40	M 50
Shelves				B M50 Velvet Lacquer S Microstructur lacquer

M 60	M 70	M 80	M 90

# Base shelf units 78 cm high NATURELOOK

Carcase depth 57.7 cm, flush with front

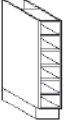

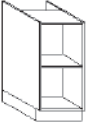


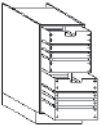


# NATURE LOOK

Order no.

W H D

## Decor groups

▲ = Types also available with 63.2 cm carcass depth (order no. ... replace ... 58 ... with 63)

	Hinge side:	Carcass depth	Decor groups												
			M10	M20	M30	M40	M50	M60	M70	M80	M90				
 <p><b>Base shelf unit</b> Prepared for 6 utensil boxes Inside depth 31.5 cm 5 fixed shelves</p>			▲	224	-	-	-	655	-	-	-	-	-	-	-
 <p><b>Utensils box</b> Finish solid oak, transparent all round, dull matt lacquered width 16.2 cm height 10.4 cm depth 31.0 cm</p>				53											
 <p><b>Base shelf unit</b> prepared for diagonal wine rack Inside depth 43.1 cm 1 fixed shelf</p>			▲	242	-	-	-	794	-	-	-	-	-	-	-
 <p><b>Diagonal wine rack</b> Finish oak veneer on 11 mm birch plywood, transparent all round, dull matt lacquered depth 42.6 cm</p>				68											
			<p> <b>Note:</b> only suitable for shelf types URC 40 78 58</p>												
 <p><b>Base shelf unit with 2 pull-outs in a supplies crate design</b> 2 supplies crate pull-outs Finish: solid oak, transparent all round, dull matt lacquered incl. burnished screws 1 fixed shelf</p>			▲	920	-	-	-	1472	-	-	-	-	-	-	-
 <p><b>Base shelf unit with 1 pull-out in a supplies crate design</b> 1 supplies crate pull-out Finish: solid oak, transparent all round, dull matt lacquered incl. burnished screws 1 fixed shelf</p>			▲	581	-	-	-	1134	-	-	-	-	-	-	-
			<p> <b>Note:</b> Cannot be combined with diagonal wine rack WD-E 40</p>												

M 10	M 20	M 30	M 40	M 50
Shelves K M10 laminate				B M50 Velvet Lacquer S Microstructur lacquer

M 60	M 70	M 80	M 90

# Base shelf units 78 cm high TAKEAWAY

Carcase depth 57.7 cm, flush with front



# TAKEAWAY

Order no.  
W H D

Hinge side:	Carcase depth	Decor groups								
		M10	M20	M30	M40	M50	M60	M70	M80	M90
☐	2258	-	-	-	2811	-	2811	-	-	
		-	-	-	2875	-	2875	-	-	
<p><b>Note:</b> Delivery is made in several packages</p>										
☐	1381	-	-	-	1936	-	1936	-	-	
		-	-	-	1986	-	1986	-	-	
<p><b>Note:</b> Delivery is made in several packages</p>										

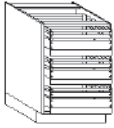
☐ = Models also available in 47.7 cm carcase depth (order no.: replace ... 58 ... with 48)



**TAKEAWAY base shelf unit**  
3 pull-out trays steel  
powder-coated black  
3 TAKEAWAY stacking boxes  
**Steel pipe powder-coated black**  
**Clear glass panel front**  
max. load-bearing capacity  
per TAKEAWAY stacking box: 18 kg

REGISTERED  
COMMUNITY  
DESIGN

**URTA 45 78 58 03**  
**URTA 60 78 58 03**



**TAKEAWAY base shelf unit**  
3 pull-out trays steel  
powder-coated black  
3 TAKEAWAY stacking boxes  
with **wooden top unit elements**  
max. load-bearing capacity  
per TAKEAWAY stacking box: 18 kg

REGISTERED  
COMMUNITY  
DESIGN

**URTAH45 78 58 03**  
**URTAH60 78 58 03**

M 10	M 20	M 30	M 40	M 50
K M10 laminate				B M50 Velvet Lacquer S M50 Microstructure Lacquer
M 60	M 70	M 80	M 90	
	F M70 veneer / oak / walnut Z M70 Veneer / Bavaria			



**Felt mat for TAKEAWAY stacking box**  
suitable for depth 57.7 cm  
suitable for depth 57.7 cm  
suitable for depth 47.7 cm  
suitable for depth 47.7 cm

<b>FM-TA 45</b>	62
<b>FM-TA 60</b>	82
<b>FM-TA 45 45</b>	51
<b>FM-TA 60 45</b>	67



**Pull-out shelf black powder-coated with guide rails**  
With locking function, full pull-out  
Substrate: 19 mm decor board in K075P black  
surface mounted metal board  
black powder-coated  
„push to open“  
for carcase width 45 cm and 60 cm  
for carcase depths 47.7 cm and 57.7 cm  
load-bearing capacity: 30 kg

REGISTERED  
COMMUNITY  
DESIGN

**TAB-AZM 45 55**  
**TAB-AZM 45 45**  
**TAB-AZM 60 55**  
**TAB-AZM 60 45**

272	-	-	-	-	-	-	-	-	-
272	-	-	-	-	-	-	-	-	-
278	-	-	-	-	-	-	-	-	-
278	-	-	-	-	-	-	-	-	-

**Note:**  
When installing in units with hinged doors always take wide angle hinges SA-90155E3 into consideration.  
**Depth 45.5 cm:** only suitable for unit models with carcase depth 45.5 cm, not for roller shutter dresser units



**TAKEAWAY stacking box**  
Suitable for pull-out tray TAB-AM...  
**Steel pipe powder-coated black**  
**Clear glass panel front**  
Latching below the base

REGISTERED  
COMMUNITY  
DESIGN

**TA 45 55**  
**TA 45 45**  
**TA 60 55**  
**TA 60 45**

412	
412	
427	
427	

**Note:**  
When installing in units with hinged doors always take wide angle hinges SA-90155E3 into account.



**TAKEAWAY wooden box tray element**  
Suitable for pull-out tray  
TAB-AM...  
Supplies box, material solid oak  
Base MDF oak veneer  
Surfaces dull matt,  
transparent lacquer  
Fitted with non-slip mat inside,  
approx. 5 mm shorter  
on all sides

REGISTERED  
COMMUNITY  
DESIGN

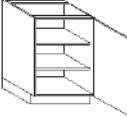
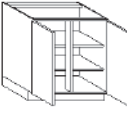
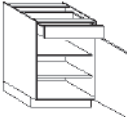
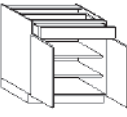

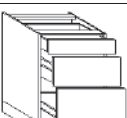
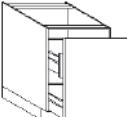

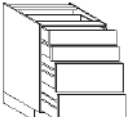
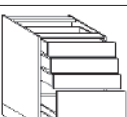
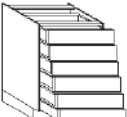

**TAH 45 55**  
**TAH 45 45**  
**TAH 60 45**  
**TAH 60 55**

129	
129	
140	
140	

**Note:**  
When installing in units with hinged doors always take wide angle hinges SA-90155E3 into account.  
**Dimensions for carcase width**  
45 cm: W x D x H 39.6 x 36.9 x 17.6 cm  
60 cm: W x D x H 54.6 x 36.9 x 17.6 cm  
In connection with TAB-AM 45/60 55, a free space remains available for individual use.

# Base units 78 cm high

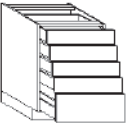
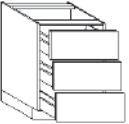
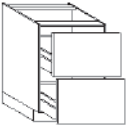
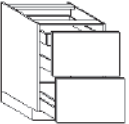
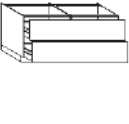


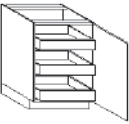

Carcase depth 70.5 cm

		Order no.	W H D		Hinge side: Carcase depth	Price groups													
						1	2	3	4	5	6	7	8	9					
776		<b>Base unit</b> 1 door 77.6 cm 2 adjustable shelves			R/L	U	30	78	70	70	264	275	302	349	368	377	410	451	-
					R/L	U	40	78	70	70	264	275	302	356	368	385	416	458	-
					R/L	U	45	78	70	70	264	275	302	356	373	398	416	458	-
					R/L	U	50	78	70	70	264	275	302	356	385	413	449	494	-
					R/L	U	60	78	70	70	302	315	326	391	436	462	498	548	-
776		<b>Base unit</b> 2 doors 77.6 cm 2 adjustable shelves				U	80	78	70	70	320	332	363	484	577	611	682	750	-
						U	90	78	70	70	320	332	363	484	577	611	684	752	-
						U	100	78	70	70	337	351	381	507	597	648	682	750	-
						U	120	78	70	70	384	408	455	602	678	722	801	881	-
126 646		<b>Base unit</b> 1 drawer 12.6 cm 1 door 64.6 cm 2 adjustable shelves			R/L	U	30	78	70	10	332	342	370	424	441	460	489	538	-
					R/L	U	40	78	70	10	332	342	370	425	441	464	494	543	-
					R/L	U	45	78	70	10	332	342	370	425	451	474	506	557	-
					R/L	U	50	78	70	10	332	342	370	425	451	478	509	560	-
					R/L	U	60	78	70	10	367	375	408	467	494	523	560	616	-
126 646		<b>Base unit</b> 1 drawer 12.6 cm with full-width panel 2 doors 64.6 cm Left door with buffer strip Without centre panel 2 adjustable shelves				U	80	78	70	10	421	435	462	596	652	685	752	827	-
						U	90	78	70	10	421	435	462	596	652	685	752	827	-
						U	100	78	70	10	431	445	476	607	663	699	769	846	-
						U	120	78	70	10	440	455	485	620	677	713	783	861	-
					 <b>Width 80, 100 Not available for:</b> GENT, INTARSIA, OSLO 15, TESSIN 15, TIM 15, VILLAGE 15-B, VILLAGE 15-S <b>Width 90, 120 Not available for:</b> INTARSIA														
126 256 386		<b>Base unit</b> 1 drawer 12.6 cm 1 pull-out 25.6 cm 1 pull-out 38.6 cm				U	30	78	70	12	652	661	712	756	756	778	826	909	-
						U	40	78	70	12	652	661	712	756	756	778	826	909	-
						U	45	78	70	12	652	661	712	756	756	778	826	909	-
						U	50	78	70	12	652	661	712	756	756	778	826	909	-
						U	60	78	70	12	685	693	740	803	803	830	885	974	-
						U	70	78	70	12	956	971	1052	1131	1144	1194	1290	1419	-
						U	80	78	70	12	956	971	1052	1131	1144	1194	1290	1419	-
						U	90	78	70	12	956	971	1052	1131	1144	1194	1290	1419	-
						U	100	78	70	12	978	1003	1087	1168	1183	1236	1337	1471	-
						U	120	78	70	12	1005	1032	1118	1206	1221	1278	1384	1522	-
776		<b>Base unit</b> 1 pull-out with front panel 77.6 cm 1 internal pull-out				U	30	78	70	012	652	661	712	756	756	778	826	909	-
						U	40	78	70	012	652	661	712	756	756	778	826	909	-
						U	45	78	70	012	652	661	712	756	756	778	826	909	-
						U	50	78	70	012	652	661	712	756	756	778	826	909	-
						U	60	78	70	012	685	693	740	803	803	830	885	974	-
126 126 256 256		<b>Base unit</b> 2 drawers 12.6 cm 2 pull-outs 25.6 cm				U	30	78	70	22	724	735	785	826	826	850	900	990	-
						U	40	78	70	22	724	735	785	826	826	850	900	990	-
						U	45	78	70	22	724	735	785	826	826	850	900	990	-
						U	50	78	70	22	724	735	785	826	826	850	900	990	-
						U	60	78	70	22	760	769	814	872	872	903	958	1054	-
						U	70	78	70	22	1026	1043	1126	1199	1216	1264	1360	1496	-
						U	80	78	70	22	1026	1043	1126	1199	1216	1264	1360	1496	-
						U	90	78	70	22	1026	1043	1126	1199	1216	1264	1360	1496	-
						U	100	78	70	22	1061	1084	1171	1250	1266	1321	1420	1562	-
						U	120	78	70	22	1095	1125	1217	1299	1317	1378	1484	1632	-
126 126 126 386		<b>Base unit</b> 3 drawers 12.6 cm 1 pull-out 38.6 cm				U	30	78	70	31	716	723	745	810	824	849	885	974	-
						U	40	78	70	31	716	723	745	810	824	849	885	974	-
						U	45	78	70	31	716	723	745	810	824	849	885	974	-
						U	50	78	70	31	716	723	745	810	824	849	885	974	-
						U	60	78	70	31	728	740	761	835	853	883	922	1014	-
						U	70	78	70	31	978	997	1075	1150	1168	1216	1312	1443	-
						U	80	78	70	31	978	997	1075	1150	1168	1216	1312	1443	-
						U	90	78	70	31	978	997	1075	1150	1168	1216	1312	1443	-
						U	100	78	70	31	1015	1037	1125	1201	1218	1271	1373	1510	-
						U	120	78	70	31	1049	1075	1170	1251	1269	1327	1433	1576	-
126 126 126 126 126		<b>Base unit</b> 6 drawers 12.6 cm				U	30	78	70	50	921	929	969	1046	1046	1062	1126	1239	-
						U	40	78	70	50	921	929	969	1046	1046	1062	1126	1239	-
						U	45	78	70	50	921	929	969	1046	1046	1062	1126	1239	-
						U	50	78	70	50	921	929	969	1046	1046	1062	1126	1239	-
						U	60	78	70	50	948	958	995	1087	1087	1114	1184	1302	-



## Base units 78 cm high

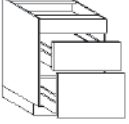
Carcase depth 70.5 cm

	Order no. W H D	Hinge side: Carcase depth	Price groups								
			1	2	3	4	5	6	7	8	9
 <p><b>Base unit</b> 4 drawers 12.6 cm 1 pull-out 25.6 cm</p>	U 30 78 70 41		788	797	816	881	897	920	958	1054	-
	U 40 78 70 41		788	797	816	881	897	920	958	1054	-
	U 45 78 70 41		788	797	816	881	897	920	958	1054	-
	U 50 78 70 41		788	797	816	881	897	920	958	1054	-
	U 60 78 70 41		802	814	832	907	924	955	993	1092	-
	U 70 78 70 41		1028	1046	1127	1199	1216	1262	1358	1494	-
	U 80 78 70 41		1028	1046	1127	1199	1216	1262	1358	1494	-
	U 90 78 70 41		1028	1046	1127	1199	1216	1262	1358	1494	-
	U 100 78 70 41		1072	1096	1183	1262	1278	1333	1434	1577	-
	U 120 78 70 41		1114	1147	1239	1327	1340	1401	1509	1660	-
 <p><b>Base unit</b> 3 pull-outs 25.6 cm Carcase depth 70.5 cm</p>	U 30 78 70 03		700	710	758	800	800	823	869	956	-
	U 40 78 70 03		700	710	758	800	800	823	869	956	-
	U 45 78 70 03		700	710	758	800	800	823	869	956	-
	U 50 78 70 03		700	710	758	800	800	823	869	956	-
	U 60 78 70 03		731	738	788	849	849	873	929	1022	-
	U 70 78 70 03		1002	1017	1096	1173	1188	1239	1335	1469	-
	U 80 78 70 03		1002	1017	1096	1173	1188	1239	1335	1469	-
	U 90 78 70 03		1002	1017	1096	1173	1188	1239	1335	1469	-
	U 100 78 70 03		1026	1046	1131	1212	1226	1280	1382	1520	-
	U 120 78 70 03		1050	1078	1165	1250	1264	1323	1427	1570	-
 <p><b>Base unit</b> 2 pull-outs 38.6 cm</p>	U 30 78 70 02		615	622	674	717	717	738	788	867	-
	U 40 78 70 02		615	622	674	717	717	738	788	867	-
	U 45 78 70 02		615	622	674	717	717	738	788	867	-
	U 50 78 70 02		615	622	674	717	717	738	788	867	-
	U 60 78 70 02		643	653	701	765	765	793	850	935	-
	U 70 78 70 02		919	932	1017	1096	1110	1161	1258	1384	-
	U 80 78 70 02		919	932	1017	1096	1110	1161	1258	1384	-
	U 90 78 70 02		919	932	1017	1096	1110	1161	1258	1384	-
	U 100 78 70 02		932	956	1038	1121	1136	1189	1289	1418	-
	U 120 78 70 02		950	975	1061	1148	1161	1217	1320	1452	-
 <p><b>Base unit</b> 1 pull-out 38.6 cm 1 internal drawer 1 pull-out 38.6 cm</p>	U 30 78 70 022		700	710	758	800	800	823	869	956	-
	U 40 78 70 022		700	710	758	800	800	823	869	956	-
	U 45 78 70 022		700	710	758	800	800	823	869	956	-
	U 50 78 70 022		700	710	758	800	800	823	869	956	-
	U 60 78 70 022		731	738	788	849	849	873	929	1022	-
	U 70 78 70 022		1002	1017	1096	1173	1188	1239	1335	1469	-
	U 80 78 70 022		1002	1017	1096	1173	1188	1239	1335	1469	-
	U 90 78 70 022		1002	1017	1096	1173	1188	1239	1335	1469	-
	U 100 78 70 022		1026	1046	1131	1212	1226	1280	1382	1520	-
	U 120 78 70 022		1050	1078	1165	1250	1264	1323	1427	1570	-
 <p><b>Base unit</b> consisting of: 2 x 90 cm wide carcasses each with 2 pull-outs Overall carcass width 180 cm 2 full-width panels 38.6 cm high and 179.6 cm wide</p>	U 180 78 70 02		1925	2008	2134	2303	2332	2440	2644	2908	-
 <p><b>Not available for:</b> ALU TEC RP, ALUELEMENTS, ATLANTA-B, ATLANTA-S, BERGEN, CASTELLO, CHALET-B, CHALET-S, CHICAGO, FENIX INOX, FRAME, HPL PRO, INTARSIA, LUGANO, LUX-B, MIAMI, MONTANA, MPX, NEVADA, NOBEL-B, NOBEL-S, ORLANDO-B, ORLANDO-S, PUR, RESOPAL PRO, RESOPAL PRO EDGE, RUSTY OAK, SMART-M, SOFIE-B, SOFIE-S, STRIP ELEMENTS, TALEA, TESSIN 15, TIM, TIM 15, VINO, VIVA, YORK-B, YORK-S</p> <p> <b>Available handles:</b> from a drilling distance of 128 mm Not available with TIP-ON Blumotion</p>											
 <p><b>Base unit</b> 1 door 77.6 cm with wide angle hinges with 3 internal drawers</p> <p><b>Planning advice:</b> Take account of opening angle</p>	U 30 78 70 73	R/L	580	586	612	682	693	719	758	834	-
	U 40 78 70 73	R/L	580	586	612	682	693	719	758	834	-
	U 45 78 70 73	R/L	580	586	612	682	694	719	758	834	-
	U 50 78 70 73	R/L	580	586	612	682	693	719	758	834	-
	U 60 78 70 73	R/L	610	621	649	719	739	766	805	886	-
<p> <b>Planning advice:</b> Doors with wide angle hinges may not be planned alongside units or panels if the protrusion to the front of the adjoining article is greater than 3 cm (hinge side). Doors with wide angle hinges protrude over the carcass side.</p>											

## Hob base units 78 cm high

Carcass depth 70.5 cm

Please follow the fitting instructions from the appliance manufacturers.

 <p><b>Hob base unit</b> 1 panel 12.6 cm 1 cable protective shelf 1 pull-out 25.6 cm 1 pull-out 38.6 cm</p>	UK 60 78 70 82		578	588	638	710	710	740	793	872	-
	UK 70 78 70 82		842	859	942	964	979	1028	1128	1241	-
	UK 80 78 70 82		842	859	942	964	979	1028	1128	1241	-
	UK 90 78 70 82		842	859	942	964	979	1028	1128	1241	-
	UK 100 78 70 82		866	887	975	1003	1018	1071	1171	1288	-
	UK 120 78 70 82		894	919	1011	1039	1057	1113	1219	1341	-
<p><b>Cutout for control panel</b></p>	UK-AA		22,80								

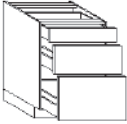
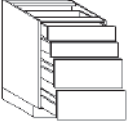
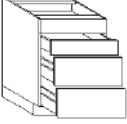
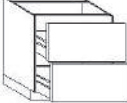
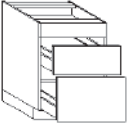
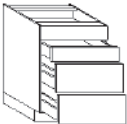
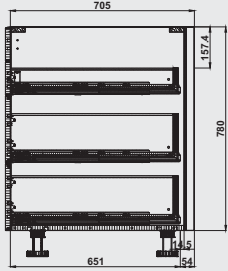


# Hob base units 78 cm high

Carcase depth 70.5 cm

Please follow the fitting instructions from the appliance manufacturers.

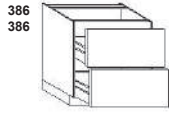
Order no.  
W H D

Hinge side:	Carcase depth	Price groups											
		1	2	3	4	5	6	7	8	9			
126 256 386		<b>Hob base unit</b>		UKI 60 78 70 12	763	772	812	880	880	907	964	1060	-
		1 drawer 12.6 cm but drawer		UKI 70 78 70 12	1031	1046	1130	1205	1219	1268	1364	1500	-
		carcase depth 55.5 cm only with low frame		UKI 80 78 70 12	1031	1046	1130	1205	1219	1268	1364	1500	-
		1 cable protective shelf		UKI 90 78 70 12	1031	1046	1130	1205	1219	1268	1364	1500	-
		1 pull-out 25.6 cm		UKI 100 78 70 12	1056	1079	1163	1243	1256	1312	1411	1552	-
1 pull-out 38.6 cm		UKI 120 78 70 12	1082	1109	1196	1280	1295	1353	1459	1605	-		
126 126 256 256		<b>Hob base unit</b>		UKI 70 78 70 22	1102	1118	1199	1274	1290	1339	1435	1579	-
		1 drawer 12.6 cm but drawer		UKI 80 78 70 22	1102	1118	1199	1274	1290	1339	1435	1579	-
		carcase depth 55.5 cm only with low frame		UKI 90 78 70 22	1102	1118	1199	1274	1290	1339	1435	1579	-
		1 cable protective shelf		UKI 100 78 70 22	1136	1159	1247	1324	1340	1394	1498	1648	-
		1 drawer 12.6 cm		UKI 120 78 70 22	1173	1198	1291	1376	1391	1452	1557	1713	-
2 pull-outs 25.6 cm													
126 126 256 256		<b>Hob base unit</b>		UK 70 78 70 81	1001	1015	1101	1174	1193	1243	1340	1474	-
		1 full-width panel 12.6 cm		UK 80 78 70 81	1001	1015	1101	1174	1193	1243	1340	1474	-
		1 cable protective shelf		UK 90 78 70 81	1001	1015	1101	1174	1193	1243	1340	1474	-
		1 drawer 12.6 cm with full-width panel		UK 100 78 70 81	1024	1045	1134	1213	1230	1284	1388	1527	-
		2 pull-outs 25.6 cm with full-width panels		UK 120 78 70 81	1049	1075	1170	1251	1269	1327	1433	1576	-
386 386		<b>Hob base unit</b>		UDK 80 78 70 028	1035	1048	1133	1212	1225	1277	1374	1511	-
		1 fixed inside panel		UDK 90 78 70 028	1035	1048	1133	1212	1225	1277	1374	1511	-
		2 pull-outs 38.6 cm		UDK 100 78 70 028	1048	1072	1153	1237	1253	1306	1405	1546	-
		with wooden rear panel		UDK 120 78 70 028	1066	1091	1177	1265	1277	1333	1435	1579	-
126 256 386		<b>Hob base unit for hob extractor</b>		UDK 80 78 70 82	842	859	942	964	979	1028	1128	1241	-
		1 panel 12.6 cm		UDK 90 78 70 82	842	859	942	964	979	1028	1128	1241	-
		1 pull-out 25.6 cm		UDK 100 78 70 82	866	887	975	1003	1018	1071	1173	1290	-
		1 pull-out 38.6 cm		UDK 120 78 70 82	894	919	1011	1039	1057	1113	1219	1341	-
				<p><b>Note:</b> The pull-outs are adapted to the respective hob extractor type. We will not assume any liability for damage caused by moisture.</p>									
126 256 256		<b>Hob base unit for hob extractor</b>		UDK 80 78 70 81	992	1010	1092	1113	1131	1179	1277	1405	-
		1 panel 12.6 cm		UDK 90 78 70 81	992	1010	1092	1113	1131	1179	1277	1405	-
		1 drawer 12.6 cm		UDK 100 78 70 81	1018	1038	1127	1153	1168	1221	1324	1456	-
		2 pull-outs 25.6 cm		UDK 120 78 70 81	1043	1070	1161	1189	1207	1265	1370	1507	-
				<p><b>Note:</b> The pull-outs are adapted to the respective hob extractor type. We will not assume any liability for damage caused by moisture.</p>									
													

# Hob base units 78 cm high

Carcase depth 70.5 cm

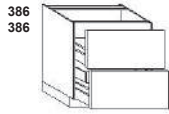
Please follow the fitting instructions from the appliance manufacturers.



**Hob base unit for hob extractor**  
 1 fixed inside panel  
 2 pull-outs 38.6 cm

Order no.  
 W H D

Hinge side:	Carcase depth	Price groups									
		1	2	3	4	5	6	7	8	9	
		UDK 80 78 70 02	919	932	1017	1096	1110	1161	1258	1384	-
		UDK 90 78 70 02	919	932	1017	1096	1110	1161	1258	1384	-
		UDK 100 78 70 02	932	956	1038	1121	1136	1189	1289	1418	-
		UDK 120 78 70 02	950	975	1061	1148	1161	1217	1320	1452	-
<p><b>Note:</b>                  The pull-outs are adapted to the respective hob extractor type.                  We will not assume any liability for damage caused by moisture.</p>											

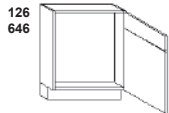


**Hob base unit for hob extractor**  
 1 fixed inside panel  
 2 pull-outs 38.6 cm  
 1 internal drawer

UDK 80 78 70 022  
 UDK 90 78 70 022  
 UDK 100 78 70 022  
 UDK 120 78 70 022

		1002	1017	1096	1173	1188	1239	1335	1469	-	
		1002	1017	1096	1173	1188	1239	1335	1469	-	
		1026	1046	1131	1212	1226	1280	1382	1520	-	
		1050	1078	1165	1250	1264	1323	1427	1570	-	
<p><b>Note:</b>                  The pull-outs are adapted to the respective hob extractor type.                  We will not assume any liability for damage caused by moisture.</p>											

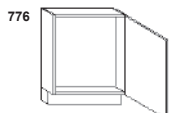
## spacefitter frame 78 cm high



**Base unit spacefitter frame**  
 1 panel 12.6 cm attached to  
 1 door 64.6 cm connected  
 Carcase depth 10 cm  
 For recess cladding

UPR 30 78 10 60  
 UPR 40 78 10 60  
 UPR 45 78 10 60  
 UPR 50 78 10 60  
 UPR 60 78 10 60

R/L	141	147	154	223	237	253	278	306	-
R/L	141	147	154	223	237	253	278	306	-
R/L	141	147	154	223	237	253	278	306	-
R/L	141	147	154	223	237	253	278	306	-
R/L	164	173	182	252	293	303	334	367	-

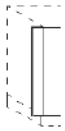




**Base unit spacefitter frame**  
 1 door 77.6 cm  
 Carcase depth 10 cm  
 For recess cladding





UPR 20 78 10 70  
 UPR 25 78 10 70  
 UPR 30 78 10 70  
 UPR 40 78 10 70  
 UPR 45 78 10 70  
 UPR 50 78 10 70  
 UPR 60 78 10 70

R/L	141	147	154	223	237	253	278	306	-
R/L	141	147	154	223	237	253	278	306	-
R/L	141	147	154	223	237	253	278	306	-
R/L	141	147	154	223	237	253	278	306	-
R/L	141	147	154	223	237	253	278	306	-
R/L	141	147	154	223	237	253	278	306	-
R/L	164	173	182	252	293	303	334	367	-

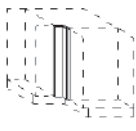



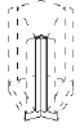


## Background filler 78 cm high

				Hinge side:	Carcase depth	Decor groups									
Order no. W H D						M10	M20	M30	M40	M50	M60	M70	M80	M90	
	<b>Base unit background filler</b> Width: 20 cm For fitting flush with carcass		<b>UPSL 00 78</b>			26,90	28,50	51	68	68	68	68	68	-	
	<b>Base unit corner background fillers</b> For corner solution 105 x 105 cm, per item		<b>UWSL 78 1</b>			54	54	69	93	91	93	93	93	-	
				 <b>Important!</b> 2 x model required for diagonal corner solution.											
				<b>UM 78</b>		39									
<b>M 10</b> K M10 laminate	<b>M 20</b> D M20 Laminate decor	<b>M 30</b> I M30 RESOPAL PRO super matt IH M30 HPL PRO PW M30 PRIMEWOOD/Basic Veneer	<b>M 40</b> A M40 DIRECTLACK matt L M40 DIRECTLACK high-gloss	<b>M 50</b> B M50 Velvet lacquer P M50 Soft lacquer S M50 microstructure lacquer											
<b>M 60</b> QH M60 SMARTGLAS high-gloss QM M60 SMARTGLAS satin-finish	<b>M 70</b> F M70 veneer / oak / walnut Z M70 Veneer / Bavaria	<b>M 80</b> C1 M80 FENIX stainless-steel look H M80 high gloss-Lacquer MP M80 laqué mat Premium	<b>M 90</b>												

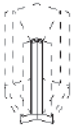
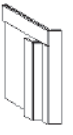
## Front filler 78 cm high

				Hinge side:	Carcase depth	Price groups								
Order no. W H D						1	2	3	4	5	6	7	8	9
	<b>Base unit front filler</b> 3.5 - 10 cm 10.1 - 20 cm		<b>UP 10 78</b>			53	53	54	86	86	86	94	103	-
			<b>UP 20 78</b>			60	60	68	117	117	117	123	135	-
	<b>Base unit front filler with buffer strip</b> 1 door 77.6 cm		<b>UPA 20 78</b>	R/L		88	88	96	144	144	144	161	177	-
	<b>Base unit front filler with grip ledge N700/775</b> minimum size 7.5 cm 3.5 - 10 cm 10.1 - 20 cm		<b>UPN 10 78</b>			53	53	54	86	86	86	94	103	-
			<i>Extra charge for N...</i>			31	31	31	31	31	31	31	31	-
			<b>UPN 20 78</b>			60	60	68	117	117	117	123	135	-
			<i>Extra charge for N...</i>			31	31	31	31	31	31	31	31	-
	<b>Base unit intermediate filler</b> 3.5 - 20 cm		<b>UPZ 20 78</b>			60	60	68	117	117	117	123	135	-
				 <b>Not available for:</b> MIAMI, VIVA										

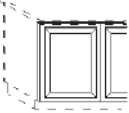
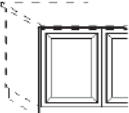
## Corner filler 78 cm high

	<b>Base unit corner filler 90°</b> 9.5 x 9.5 cm up to 20 x 20 cm		 <b>Important!</b> Planning dimensions 65 x 65 cm Items can only be fitted in the ALU TEC RP models with a minimum size of 6 x 6 cm.											
			<b>UPW 65 78</b>			89	89	105	118	118	118	131	144	-
			<b>UPW 75 78</b>			99	99	111	125	125	125	163	179	-
	<b>Base unit corner filler 90° with grip ledge N700/775</b> 9.5 x 9.5 cm up to 20 x 20 cm		 <b>Important!</b> Planning dimensions 65 x 65 cm											
			<b>UPWN 65 78</b>			89	89	105	118	118	118	131	144	-
			<i>Extra charge for N...</i>			62	62	62	62	62	62	62	62	-
			<b>UPWN 75 78</b>			99	99	111	125	125	125	163	179	-
			<i>Extra charge for N...</i>			62	62	62	62	62	62	62	62	-
	<b>Base unit corner filler 135°</b> For corner solution 105 x 105 cm		<b>UPW 135 78</b>			89	89	105	118	118	118	131	144	-
				 <b>Not available for:</b> ALU TEC RP										
				 <b>Important!</b> Planning dimensions 25.9 x 25.9 cm 2 x model required for diagonal corner solution.										



# Corner filler 78 cm high

		Price groups													
		Order no.			Hinge side:	Carcase depth	1	2	3	4	5	6	7	8	9
		W H D													
 <p><b>Base unit corner filler for variable corner solutions / diagonal solutions</b> min. planning dimension 25.9 cm max. planning dimension 38 cm</p>		<b>UPW 00 78</b>					99	99	111	125	125	125	163	179	-
		<p><b>Not available for:</b> ALU TEC RP</p> <p><b>Important!</b> 2 x model required for diagonal corner solution.</p> <p><b>Note:</b> Please specify the precise angle and angle leg. With angles less than 90°, please do not plan pull-outs/drawers or dishwashers in the corner.</p>													
 <p><b>Base unit corner filler 90° for height offset</b></p>		<b>UPH 65 78 65</b>			R/L		120	120	131	143	143	143	159	175	-
		<b>UPH 65 78 72</b>			R/L		120	120	131	143	143	143	159	175	-
		<p><b>Not available for:</b> ALU TEC RP, MIAMI, VIVA</p> <p><b>Important!</b> Planning dimensions 65 x 65 cm</p>													

# Back cladding 78 cm high with screw-fitted fronts

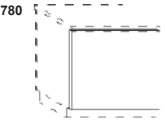

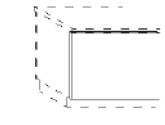

 <p><b>Back cladding</b> for base units, 78 cm high Carcase material With screw-fitted fronts 77.6 cm only available in grid sizes</p>		<p><b>Important!</b> Observe worktop excess depth 66 cm! The plinth panel required is supplied loose.</p>													
		per 10 cm Width													
		<b>UVF 78</b>					38	41	45	64	66	69	75	83	-
 <p><b>Back cladding</b> for base units, 78 cm high carcase material extends down to floor level With screw-fitted fronts 77.6 cm Only available in grid sizes</p>		<p><b>Important!</b> Observe worktop excess depth 66 cm! The plinth panel required is supplied loose.</p>													
		per 10 cm Width													
		<b>UVF 00 78</b>					38	41	45	64	66	69	75	83	-

# Support panel 78 cm high

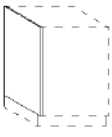

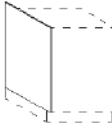

		Decor groups													
		Order no.			Hinge side:	Carcase depth	M10	M20	M30	M40	M50	M60	M70	M80	M90
		W H D													
 <p><b>Base unit support panel</b> 60 cm deep, 98 cm high without plinth cutout Height to be adapted on site</p>		<b>USW 98 60</b>					46	147	284	378	378	378	378	378	-
 <p><b>Base unit support panel</b> 90 cm deep, 98 cm high without plinth cutout Height to be adapted on site</p>		<b>USW 98 90</b>					48	173	317	422	422	422	422	422	-

M 10	M 20	M 30	M 40	M 50
K M10 laminate	D M20 Laminate decor	I M30 RESOPAL PRO super matt IH M30 HPL PRO PW M30 PRIMEWOOD/Basic Veneer	A M40 DIRECTLACK matt L M40 DIRECTLACK high-gloss	B M50 Velvet lacquer S M50 microstructure lacquer
M 60	M 70	M 80	M 90	
QH M60 SMARTGLAS high-gloss QM M60 SMARTGLAS satin-finish	F M70 veneer / oak / walnut Z M70 Veneer / Bavaria	C1 M80 FENIX stainless-steel look H M80 high gloss-Lacquer MP M80 laqué mat Premium		

# Back cladding 78 cm high

		Decor groups														
		Order no.	W	H	D	Hinge side:	Carcass depth	M10	M20	M30	M40	M50	M60	M70	M80	M90
 <p><b>Back cladding</b> With suspension fittings for base units, 78 cm high 16 mm thick</p>	per 10 cm Width	<b>UVK 78</b>						9,10	15,80	39	51	51	51	51	51	-
		 <b>Important!</b> Observe worktop excess depth 64 cm! The plinth panel required is supplied loose.														
 <p><b>Back cladding</b> With suspension fittings For base units 16 mm thick variable height</p>	per m <sup>2</sup> , W x H	<b>UVK 00</b>						118	200	483	644	644	644	644	644	-
		<b>minimum price</b>							47	50	73	134	74	134	121	134
		 <b>Important!</b> Observe worktop excess depth 64 cm! The plinth panel required is supplied loose.														
<b>M 10</b>	<b>M 20</b>	<b>M 30</b>	<b>M 40</b>		<b>M 50</b>											
K M10 laminate	D M20 Laminate decor	I M30 RESOPAL PRO super matt IH M30 HPL PRO PW M30 PRIMEWOOD/Basic Veneer	A M40 DIRECTLACK matt L M40 DIRECTLACK high-gloss		B M50 Velvet lacquer S M50 microstructure lacquer											
<b>M 60</b>	<b>M 70</b>	<b>M 80</b>	<b>M 90</b>													
QH M60 SMARTGLAS high-gloss QM M60 SMARTGLAS satin-finish	F M70 veneer / oak / walnut Z M70 Veneer / Bavaria	C1 M80 FENIX stainless-steel look H M80 high gloss-Lacquer MP M80 laqué mat Premium														

## Visible sides / increased side depth 78 cm high

 <p><b>Base unit visible side</b> 55.5 cm side depth Fixed dimension, not variable 57.5 cm side depth Fixed dimension, not variable 60.5 cm side depth Fixed dimension, not variable 61 cm side depth Fixed dimension, not variable 70.5 cm side depth Fixed dimension, not variable</p>		<b>USV 78</b>	R/L			0	0	67	67	89	89	112	141	-		
		<b>USV 78 5</b>	R/L			0	0	67	67	89	89	112	141	-		
		<b>USV 78 6</b>	R/L			0	0	67	67	89	89	112	141	-		
		<b>USV 78 6 1</b>	R/L			0	0	67	67	89	89	112	141	-		
		<b>USV 78 7</b>	R/L			0	0	67	67	89	89	112	141	-		
		 <b>Important!</b> Installation instead of a normal unit side. <b>Only available in the listed side depths.</b> For other dimensions, use USVT...														
 <p><b>Base unit increased side depth</b> from 61.1 cm up to 90 cm side depth Up to 60.9 cm side depth</p>		<b>USVT 78</b>	R/L			73	73	147	147	196	196	244	281	-		
		<b>USVT 78 6</b>	R/L			37	37	98	98	130	130	162	207	-		
		 <b>Important!</b> Installation instead of a normal unit side.														
<b>M 10</b>	<b>M 20</b>	<b>M 30</b>	<b>M 40</b>		<b>M 50</b>											
K M10 laminate	D M20 Laminate decor	I M30 RESOPAL PRO super matt IH M30 HPL PRO PW M30 PRIMEWOOD/Basic Veneer	A M40 DIRECTLACK matt L M40 DIRECTLACK high-gloss		B M50 Velvet lacquer P M50 Soft lacquer RH M50 Velvet lacquer wood texture RW M50 Velvet lacquer spackle effect S M50 microstructure lacquer											
<b>M 60</b>	<b>M 70</b>	<b>M 80</b>	<b>M 90</b>													
QH M60 SMARTGLAS high-gloss QM M60 SMARTGLAS satin-finish	F M70 veneer / oak / walnut V M70 Velvet lacquer textured Z M70 Veneer / Bavaria	C1 M80 FENIX stainless-steel look H M80 high gloss-Lacquer MP M80 laqué mat Premium O M80 Veneered														



# 3.4

## Base units 78 cm high PREMIUMLINE

Base units 26 cm high	XL 3.4.2
Base units 52 cm high	XL 3.4.2
Base units 78 cm high	XL 3.4.2-XL 3.4.3
Hob base units 78 cm high	XL 3.4.3
Hob base units 78 cm high for hob extractors	XL 3.4.3
Sink carcases 78 cm high	XL 3.4.4
Fronts for electrical appliances	XL 3.4.5
Corner base units 78 cm high Le Mans	XL 3.4.5
Base units 26 cm high	XL 3.4.5
Base units 52 cm high	XL 3.4.5
Base units 78 cm high	XL 3.4.6
Background filler 78 cm high	XL 3.4.7
Corner filler 78 cm high	XL 3.4.7
Back cladding 78 cm high with screw-fitted fronts	XL 3.4.7
Support panel 78 cm high	XL 3.4.7-XL 3.4.8
Back cladding 78 cm high	XL 3.4.8
Visible sides / increased side depth 78 cm high	XL 3.4.8

### Legend:



Available with grip ledge N...



Not available with grip ledge N...



This symbol indicates which models are available



This symbol indicates which models are not available



wall-mounted units



available depths for wall-mounted units



Planning advice



Not available with „push-to-open“ fitting



Available carcass depths 34/45.5/55.5/61.0 cm



Available carcass depths 45.5/55.5/61.0 cm



Available carcass depths 55.5/61.0 cm





# The most important base unit models 78 cm high

Page XL 3.4.2	Page XL 3.4.2	Page XL 3.4.2	Page XL 3.4.2	Page XL 3.4.2	Page XL 3.4.2	Page XL 3.4.2	Page XL 3.4.2	Page XL 3.4.3
PU..265501 Unit widths: 30/40/45/50/60 80/90/100/120	PU..2655011 Unit widths: 30/40/45/50/60	PU..5255011 Unit widths: 30/40/45/50/60	PU..785560 Unit widths: 30/40/45/50/60	PU..785560 Unit widths: 80/90/100/120	PU..785590 Unit widths: 30/40/45/50/60	PU..785590 Unit widths: 80/90/100/120	PU..7855901 Unit widths: 30/40/45/50/60	PU..7855901 Unit widths: 80/90/100/120
Page XL 3.4.3	Page XL 3.4.3	Page XL 3.4.3	Page XL 3.4.3	Page XL 3.4.3	Page XL 3.4.4	Page XL 3.4.4	Page XL 3.4.4	Page XL 3.4.4
PU..7855921 Unit widths: 30/40/45/50/60 70/80/90/100	PU..7855902 Unit widths: 30/40/45/50/60 70/80/90/100	PU..7855922 Unit widths: 30/40/45/50/60 70/80/90/100	PUKI..7855911 Unit widths: 60/80/90/100	PUDK..7855911 Unit widths: 60/80/90/100	PUS..7855951 Unit widths: 45/50/60	PUS..7855701 Unit widths: 40/45/50/60	PUS..7855701 Unit widths: 80/90/100/120	PUS..7855702 Unit widths: 40/45/50/60
Page XL 3.4.4	Page XL 3.4.4	Page XL 3.4.4	Page XL 3.4.5	Page XL 3.4.5	Page XL 3.4.5	Page XL 3.4.5	Page XL 3.4.5	Page XL 3.4.6
PUS..7855702 Unit widths: 80/90/100/120	PUS..7855827 Unit widths: 60/80/90/100	PUS..7855826 Unit widths: 60/70/80/90/100	PUTV..78 Unit widths: 45/60	PUE..785564 Unit widths: 110/115/125	PU..267001 Unit widths: 30/40/45/50/60 80/90/100/120	PU..2670011 Unit widths: 30/40/45/50/60 80/90/100/120	PU..5270011 Unit widths: 30/40/45/50/60	PU..787060 Unit widths: 30/40/45/50/60
Page XL 3.4.6	Page XL 3.4.6	Page XL 3.4.6	Page XL 3.4.6	Page XL 3.4.6	Page XL 3.4.6	Page XL 3.4.6	Page XL 3.4.6	Page XL 3.4.7
PU..787060 Unit widths: 80/90/100/120	PU..787090 Unit widths: 30/40/45/50/60	PU..787090 Unit widths: 80/90/100/120	PU..7870901 Unit widths: 30/40/45/50/760	PU..7870901 Unit widths: 80/90/100/120	PU..7870921 Unit widths: 30/40/45/50/60	PU..7870922 Unit widths: 30/40/45/50/60	PU..7870902 Unit widths: 30/40/45/50/60	PUPT..78 Unit widths: 3,5-20
Page XL 3.4.7	Page XL 3.4.7							
PUPWT..78 Unit widths: 65x65/75x75	UVF.. Unit widths:							

## Base units 26 cm high

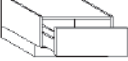
Carcase depth 55.5 cm (standard)


■ = Models also available in 34/45.5/61 cm carcass depth (Order no.: ... replace ... 55 ... with 34/45/61)  
 □ = Models also available in 45.5/61 cm carcass depth (order no.: replace ... 55 ... with 45/61)

## PREMIUM LINE

Order no.  
W H D

Hinge side:	Carcass depth	Price groups									
		1	2	3	4	5	6	7	8	9	
■	55.5	PU 30 26 55 01	252	255	280	314	314	325	357	393	-
		PU 40 26 55 01	252	255	280	314	314	325	357	393	-
		PU 45 26 55 01	252	255	280	314	314	325	357	393	-
		PU 50 26 55 01	252	255	280	314	314	325	357	393	-
		PU 60 26 55 01	269	275	302	341	341	360	391	430	-
		PU 70 26 55 01	431	440	488	540	547	576	633	696	-
		PU 80 26 55 01	431	440	488	540	547	576	633	696	-
		PU 90 26 55 01	431	440	488	540	547	576	633	696	-
		PU 100 26 55 01	441	448	500	552	560	594	651	716	-
		PU 120 26 55 01	448	462	516	566	576	610	668	735	-
Width 30, 40, 45, 50, 60, 80, 90, 100, 120 Width 70 Not available for: ALUELEMENTS, MIAMI, STRIP ELEMENTS, VIVA											

256  **Base unit**  
1 pull-out 25.6 cm

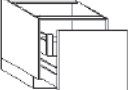
256  **Base unit**  
1 drawer 25.6 cm  
1 internal drawer

■	55.5	PU 30 26 55 011	335	343	371	400	406	417	443	487	-
		PU 40 26 55 011	335	343	371	400	406	417	443	487	-
		PU 45 26 55 011	335	343	371	400	406	417	443	487	-
		PU 50 26 55 011	335	343	371	400	406	417	443	487	-
		PU 60 26 55 011	352	363	393	427	434	451	477	525	-
		PU 70 26 55 011	518	529	577	629	635	663	723	795	-
		PU 80 26 55 011	518	529	577	629	635	663	723	795	-
		PU 90 26 55 011	518	529	577	629	635	663	723	795	-
		PU 100 26 55 011	529	537	588	641	649	679	741	815	-
		PU 120 26 55 011	536	551	605	655	665	696	758	834	-
Width 30, 40, 45, 50, 60, 80, 90, 100, 120 Width 70 Not available for: ALUELEMENTS, MIAMI, STRIP ELEMENTS, VIVA											

## Base units 52 cm high

Carcass depth 55.5 cm (standard)

■ = Models also available in 34/45.5/61 cm carcass depth (Order no.: ... replace ... 55 ... with 34/45/61) □ = Models also available in 45.5/61 cm carcass depth (order no.: replace ... 55 ... with 45/61)

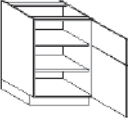
516  **Base unit**  
1 pull-out 51.6 cm  
1 internal pull-out

■	55.5	PU 30 52 55 011	426	436	485	536	536	559	597	657	-
		PU 40 52 55 011	426	436	485	536	536	559	597	657	-
		PU 45 52 55 011	426	436	485	536	536	559	597	657	-
		PU 50 52 55 011	426	436	485	536	536	559	597	657	-
		PU 60 52 55 011	461	471	517	582	582	615	666	733	-
		PU 70 52 55 011	736	749	834	917	932	983	1080	1188	-
		PU 80 52 55 011	736	749	834	917	932	983	1080	1188	-
		PU 90 52 55 011	736	749	834	917	932	983	1080	1188	-
		PU 100 52 55 011	756	772	856	943	956	1012	1110	1221	-
		Width 30, 40, 45, 50, 60 Width 70 Not available for: ALUELEMENTS, MIAMI, STRIP ELEMENTS, VIVA Width 80, 90, 100 Not available for: MIAMI, VIVA									

## Base units 78 cm high

Carcass depth 55.5 cm (standard)

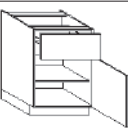
■ = Models also available in 34/45.5/61 cm carcass depth (Order no.: ... replace ... 55 ... with 34/45/61) □ = Models also available in 45.5/61 cm carcass depth (order no.: replace ... 55 ... with 45/61)

256 516  **Base unit**  
1 panel 25.6 cm attached to 1 door 51.6 cm  
2 adjustable shelves

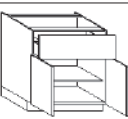
■	55.5	PU 30 78 55 60	R/L	182	191	214	264	284	299	329	362	-
		PU 40 78 55 60	R/L	182	191	214	271	284	303	332	365	-
		PU 45 78 55 60	R/L	182	191	214	271	284	303	332	365	-
		PU 50 78 55 60	R/L	182	191	214	271	303	325	364	400	-
		PU 60 78 55 60	R/L	215	227	245	308	354	377	419	461	-
		Width 80, 100 Not available for: GENT, INTARSIA, OSLO 15, TESSIN 15, TIM 15, VILLAGE 15-B, VILLAGE 15-S Width 90, 120										

256 516  **Base unit**  
2 panels 25.6 cm attached to 2 doors 51.6 cm  
2 adjustable shelves

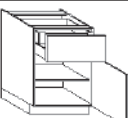
■	55.5	PU 80 78 55 60	244	253	282	407	490	532	598	658	-
		PU 90 78 55 60	244	253	282	407	490	532	599	659	-
		PU 100 78 55 60	255	267	300	430	490	532	601	661	-
		PU 120 78 55 60	295	312	359	508	581	628	708	779	-
Width 80, 100 Not available for: GENT, INTARSIA, OSLO 15, TESSIN 15, TIM 15, VILLAGE 15-B, VILLAGE 15-S Width 90, 120											

256 516  **Base unit**  
1 pull-out 25.6 cm  
1 door 51.6 cm  
1 adjustable shelf

■	55.5	PU 30 78 55 90	R/L	282	299	333	400	424	448	482	530	-
		PU 40 78 55 90	R/L	282	299	333	401	424	451	487	536	-
		PU 45 78 55 90	R/L	282	299	333	401	440	460	496	546	-
		PU 50 78 55 90	R/L	282	299	333	401	440	462	500	550	-
		PU 60 78 55 90	R/L	315	333	374	445	485	514	561	617	-

256 516  **Base unit**  
1 pull-out 25.6 cm  
2 doors 51.6 cm  
1 adjustable shelf

■	55.5	PU 80 78 55 90	392	425	459	608	692	717	793	872	-
		PU 90 78 55 90	392	425	459	608	692	717	793	872	-
		PU 100 78 55 90	400	437	470	624	704	730	811	892	-
		PU 120 78 55 90	410	447	480	637	717	743	826	909	-
Width 80, 100 Not available for: GENT, INTARSIA, OSLO 15, TESSIN 15, TIM 15, VILLAGE 15-B, VILLAGE 15-S Width 90, 120 Not available for: INTARSIA, STRIP ELEMENTS											

256 516  **Base unit**  
1 drawer 25.6 cm  
1 internal drawer  
1 door 51.6 cm  
1 adjustable shelf

■	55.5	PU 30 78 55 901	R/L	366	387	424	487	516	540	568	625	-
		PU 40 78 55 901	R/L	366	387	424	488	516	542	572	629	-
		PU 45 78 55 901	R/L	366	387	424	488	532	551	582	640	-
		PU 50 78 55 901	R/L	366	387	424	488	532	553	585	644	-
		PU 60 78 55 901	R/L	398	421	465	532	578	605	647	712	-

## Base units 78 cm high

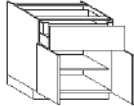


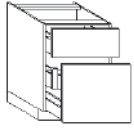


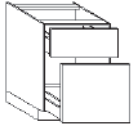


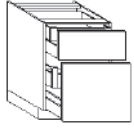


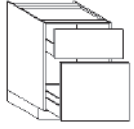



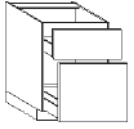



Carcase depth 55.5 cm (standard)

■ = Models also available in 34/45.5/61 cm carcass depth (Order no.: ... replace ... 55 ... with 34/45/61)  
 □ = Models also available in 45.5/61 cm carcass depth (order no.: replace ... 55 ... with 45/61)

## PREMIUM LINE

Order no.

W H D

Hinge side:	Carcass depth	Price groups												
		1	2	3	4	5	6	7	8	9				
256 516		<b>Base unit</b> 1 drawer 25.6 cm 1 internal drawer 2 doors 51.6 cm 1 adjustable shelf		PU 80 78 55 901	■	480	514	548	697	781	803	883	971	-
				PU 90 78 55 901	■	480	514	548	697	781	803	883	971	-
				PU 100 78 55 901	■	488	526	559	713	793	816	901	991	-
				PU 120 78 55 901	■	498	536	569	725	806	830	916	1008	-
				 Width 80, 100 Not available for: GENT, INTARSIA, OSLO 15, TESSIN 15, TIM 15, VILLAGE 15-B, VILLAGE 15-S Width 90, 120 Not available for: INTARSIA, STRIP ELEMENTS										
256 516		<b>Base unit</b> 1 pull-out 25.6 cm 1 pull-out 51.6 cm 1 internal pull-out		PU 30 78 55 921	■	595	602	650	702	702	722	774	851	-
				PU 40 78 55 921	■	601	608	656	708	708	731	782	860	-
				PU 45 78 55 921	■	602	610	657	709	709	732	783	861	-
				PU 50 78 55 921	■	603	611	661	710	710	735	784	862	-
				PU 60 78 55 921	■	650	663	705	773	773	803	858	944	-
				PU 80 78 55 921	□	1047	1062	1142	1219	1234	1284	1380	1518	-
				PU 70 78 55 921	□	1047	1062	1142	1219	1234	1284	1380	1518	-
				PU 90 78 55 921	□	1047	1062	1142	1219	1234	1284	1380	1518	-
				PU 100 78 55 921	□	1072	1092	1177	1257	1272	1326	1428	1571	-
								 Width 30, 40, 45, 50, 60 Width 70 Not available for: ALUELEMENTS, MIAMI, STRIP ELEMENTS, VIVA Width 80, 90, 100 Not available for: MIAMI, VIVA						
256 516		<b>Base unit</b> 1 pull-out 25.6 cm 1 pull-out 51.6 cm		PU 30 78 55 902	■	436	444	492	546	546	568	620	682	-
				PU 40 78 55 902	■	436	444	492	546	546	568	620	682	-
				PU 45 78 55 902	■	436	444	492	546	546	568	620	682	-
				PU 50 78 55 902	■	436	444	492	546	546	568	620	682	-
				PU 60 78 55 902	■	467	480	524	596	596	623	681	749	-
				PU 80 78 55 902	□	747	764	850	935	950	1003	1101	1211	-
				PU 70 78 55 902	□	747	764	850	935	950	1003	1101	1211	-
				PU 90 78 55 902	□	747	764	850	935	950	1003	1101	1211	-
				PU 100 78 55 902	□	767	783	871	961	976	1029	1133	1246	-
								 Width 30, 40, 45, 50, 60 Width 70 Not available for: ALUELEMENTS, MIAMI, STRIP ELEMENTS, VIVA Width 80, 90, 100 Not available for: MIAMI, VIVA						
256 516		<b>Base unit</b> 1 drawer 25.6 cm 1 internal drawer 1 pull-out 51.6 cm 1 internal pull-out		PU 30 78 55 922	■	731	743	794	842	848	866	913	1004	-
				PU 40 78 55 922	■	738	749	801	848	853	876	921	1013	-
				PU 45 78 55 922	■	739	750	802	849	854	877	922	1014	-
				PU 50 78 55 922	■	740	752	806	850	855	879	923	1015	-
				PU 60 78 55 922	■	787	803	850	913	919	948	996	1096	-
				PU 80 78 55 922	□	1223	1239	1319	1395	1411	1459	1557	1713	-
				PU 70 78 55 922	□	1223	1239	1319	1395	1411	1459	1557	1713	-
				PU 90 78 55 922	□	1223	1239	1319	1395	1411	1459	1557	1713	-
				PU 100 78 55 922	□	1248	1269	1353	1434	1449	1501	1605	1766	-
								 Width 30, 40, 45, 50, 60 Width 70 Not available for: ALUELEMENTS, MIAMI, STRIP ELEMENTS, VIVA Width 80, 90, 100 Not available for: MIAMI, VIVA						
<b>Hob base units 78 cm high</b>														
Carcass depth 55.5 cm (standard)														
Please follow the fitting instructions from the appliance manufacturers. ▲ = Types also available with 61 cm carcass depth (order no. ... replace ... 55 ... with 61)														
256 516		<b>Hob base unit for induction hobs</b> 1 drawer 25.6 cm 1 heat shield 1 pull-out 51.6 cm		PUKI 60 78 55 911	▲	600	610	656	722	722	754	808	889	-
				PUKI 80 78 55 911	▲	908	923	1008	1089	1105	1153	1255	1381	-
				PUKI 90 78 55 911	▲	915	929	1013	1094	1112	1160	1260	1386	-
				PUKI 100 78 55 911	▲	956	976	1065	1147	1164	1219	1323	1455	-
								 Width 60 Width 80, 90, 100 Not available for: MIAMI, VIVA  Note: Cutlery organisers are not available for this article.						
<b>Hob base units 78 cm high for hob extractors</b>														
Carcass depth 55.5 cm (standard)														
Please follow the fitting instructions from the appliance manufacturers. ▲ = Types also available with 61 cm carcass depth (order no. ... replace ... 55 ... with 61)														
256 516		<b>Hob base unit for hob extractor</b> 1 fixed inside panel 1 drawer 25.6 cm 1 pull-out 51.6 cm		PUDK 60 78 55 911	▲	747	764	850	935	950	1003	1101	1211	-
				PUDK 80 78 55 911	▲	747	764	850	935	950	1003	1101	1211	-
				PUDK 90 78 55 911	▲	767	783	871	961	976	1029	1133	1246	-
				PUDK 100 78 55 911	▲	783	803	895	986	1003	1061	1163	1279	-
								 Width 60 Width 80, 90, 100 Not available for: MIAMI, VIVA  Note: The pull-outs are adapted to the respective hob extractor type. We will not assume any liability for damage caused by moisture.						

# Sink carcasses 78 cm high

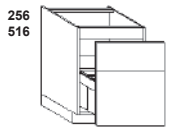
Carcase depth 55.5 cm (standard)

□ = Models also available in 45.5/61 cm carcass depth (order no.: replace ... 55 ... with 45/61)  
 ▲ = Types also available with 61 cm carcass depth (order no. ... replace ... 55 ... with 61)

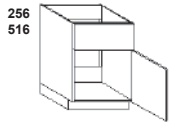
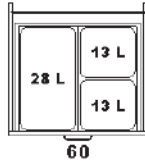
## PREMIUM LINE

Order no.  
W H D

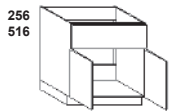
Hinge side:	Carcass depth	Price groups									
		1	2	3	4	5	6	7	8	9	
▲	55.5	PUS 45 78 55 951	561	571	587	648	682	703	735	809	-
		PUS 50 78 55 951	568	578	596	653	689	717	747	822	-
		PUS 60 78 55 951	612	626	646	711	748	772	812	893	-
Not available with TIP-ON											
R/L ▲	55.5	PUS 40 78 55 701	205	215	231	292	325	347	377	415	-
		PUS 45 78 55 701	207	216	233	293	326	349	378	416	-
		PUS 50 78 55 701	208	217	235	294	329	357	389	428	-
		PUS 60 78 55 701	236	252	270	337	373	398	437	481	-
R/L ▲	55.5	PUS 80 78 55 701	270	287	315	446	517	557	622	684	-
		PUS 90 78 55 701	275	290	319	448	519	559	625	688	-
		PUS 100 78 55 701	292	302	334	479	523	561	629	692	-
		PUS 120 78 55 701	331	356	396	552	602	647	730	803	-
		Width 80, 100 Not available for: GENT, INTARSIA, OSLO 15, TESSIN 15, TIM 15, VILLAGE 15-B, VILLAGE 15-S Width 90, 120									
R/L □	55.5	PUS 40 78 55 702	181	191	211	268	303	323	360	396	-
		PUS 45 78 55 702	181	191	211	268	303	323	360	396	-
		PUS 50 78 55 702	181	191	211	268	303	329	365	402	-
		PUS 60 78 55 702	211	224	245	312	349	369	410	451	-
□	55.5	PUS 80 78 55 702	235	251	277	412	481	522	584	642	-
		PUS 90 78 55 702	235	251	277	412	481	522	586	645	-
		PUS 100 78 55 702	250	260	295	437	481	522	587	646	-
		PUS 120 78 55 702	288	308	349	506	557	603	685	754	-
		Width 80, 100 Not available for: GENT, INTARSIA, OSLO 15, TESSIN 15, TIM 15, VILLAGE 15-B, VILLAGE 15-S Width 90, 120									
▲	55.5	PUS 60 78 55 827	660	674	712	773	788	812	849	934	-
		PUS 80 78 55 827	1050	1059	1094	1124	1144	1193	1241	1365	-
		PUS 90 78 55 827	1050	1059	1094	1124	1144	1193	1241	1365	-
		PUS 100 78 55 827	1085	1095	1132	1168	1189	1242	1293	1422	-
Width 60, 80, 90, 100 Not available for: MIAMI, VIVA											
▲	55.5	PUS 70 78 55 826	690	699	732	772	793	840	887	976	-
		PUS 80 78 55 826	690	699	732	772	793	840	887	976	-
		PUS 90 78 55 826	690	699	732	772	793	840	887	976	-
		PUS 100 78 55 826	718	726	763	808	830	883	933	1026	-
Width 60 Width 70 Not available for: ALUELEMENTS, MIAMI, STRIP ELEMENTS, VIVA Width 80, 90, 100 Not available for: MIAMI, VIVA											
Extra charge Sink carcass with full back panel		SA50SVR	34								



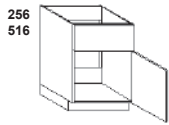
**Sink carcass**  
 1 panel 25.6 cm attached to  
 1 front 51.6 cm  
 with frame and waste bin  
 for dropping in (Hailo) 1 inside panel



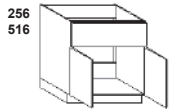
**Sink carcass**  
 1 panel 25.6 cm  
 1 door 51.6 cm  
 1 aluminium protective shelf



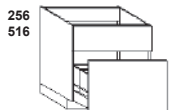
**Sink carcass**  
 1 full-width panel 25.6 cm  
 2 doors 51.6 cm  
 1 aluminium protective shelf  
 Left door with buffer strip  
 Without centre panel



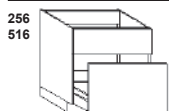
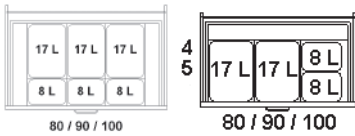
**Sink carcass**  
 1 panel 25.6 cm  
 1 door 51.6 cm  
 without aluminium protective shelf



**Sink carcass**  
 1 full-width panel 25.6 cm  
 2 doors 51.6 cm  
 without aluminium protective shelf  
 Left door with buffer strip  
 Without centre panel



**Sink carcass**  
 1 panel 25.6 cm  
 1 pull-out 51.6 cm  
 1 waste system in bottom pull-out



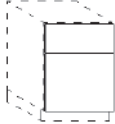
**Sink carcass**  
 1 panel 25.6 cm  
 1 pull-out 51.6 cm

# Fronts for electrical appliances

Hinge side:	Carcase depth	Price groups								
		1	2	3	4	5	6	7	8	9

Please specify the dishwasher item number when ordering.

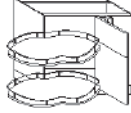
Order no.  
W H D

<p>256 516</p>  <p><b>Base unit door, 77.6 cm</b> 1 panel 25.6 cm attached to 1 door 51.6 cm</p> <p>As front panel for fully integrated dishwashers 86 cm high and pull-out fridges and freezers</p> <p><i>Surcharge in connection with the grip rails N700 and N775 incl. connecting plate and additional grip rails</i></p> <p><i>Surcharge in connection with the grip rails N700 and N775 incl. connecting plate and additional grip rails</i></p>																				

## Corner base units 78 cm high Le Mans

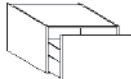
Carcase depth 55.5 cm (standard)

▲ = Types also available with 61 cm carcase depth (order no. ... replace ... 55 ... with 61)

<p>256 516</p>  <p><b>Corner base unit „Le Mans“</b> Blind section left or right 1 panel 25.6 cm attached to 1 door 51.6 cm</p> <p>2 wooden carousel shelves with chrome-plated rail fully swivelling „Le Mans“ Carcase width 100 cm with loose corner filler</p> <p>Door 45 cm Door 50 cm Door 60 cm</p> <p><b>Extra charge for extending corner filler width</b></p>																				

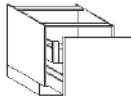
## Base units 26 cm high

Carcase depth 70.5 cm

<p>256</p>  <p><b>Base unit</b> 1 pull-out 25.6 cm Carcase depth 70.5 cm</p>																				

## Base units 52 cm high

Carcase depth 70.5 cm

<p>516</p>  <p><b>Base unit</b> 1 pull-out 51.6 cm 1 internal pull-out Carcase depth 70.5 cm</p>																				



# Base units 78 cm high

Carcase depth 70.5 cm

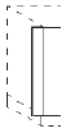


# PREMIUM LINE

Order no.  
W H D

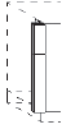

Hinge side:	Carcase depth	Price groups											
		1	2	3	4	5	6	7	8	9			
R/L	70.5	256 516	Base unit 1 panel 25.6 cm attached to 1 door 51.6 cm  2 adjustable shelves Carcase depth 70.5 cm	PU 30 78 70 60	264	275	302	349	368	377	410	451	-
		PU 40 78 70 60		264	275	302	356	368	385	416	458	-	
		PU 45 78 70 60		264	275	302	356	373	398	416	458	-	
		PU 50 78 70 60		264	275	302	356	385	413	449	494	-	
		PU 60 78 70 60		302	315	326	391	436	462	498	548	-	
R/L	70.5	256 516	Base unit 2 panels 25.6 cm attached to 2 doors 51.6 cm  2 adjustable shelves Carcase depth 70.5 cm	PU 80 78 70 60	320	332	363	484	577	611	682	750	-
		PU 90 78 70 60		320	332	363	484	577	611	682	750	-	
		PU 100 78 70 60		337	351	381	507	597	648	744	818	-	
		PU 120 78 70 60		384	408	455	602	678	722	801	881	-	
		Width 80, 100 Not available for: GENT, INTARSIA, OSLO 15, TESSIN 15, TIM 15, VILLAGE 15-B, VILLAGE 15-S Width 90, 120											
R/L	70.5	256 516	Base unit 1 pull-out 25.6 cm 1 door 51.6 cm 1 adjustable shelf Carcase depth 70.5 cm	PU 30 78 70 90	449	466	501	568	593	617	650	715	-
		PU 40 78 70 90		449	466	501	569	593	619	654	719	-	
		PU 45 78 70 90		449	466	501	569	607	628	665	732	-	
		PU 50 78 70 90		449	466	501	569	607	630	668	735	-	
		PU 60 78 70 90		482	501	542	613	653	682	728	801	-	
R/L	70.5	256 516	Base unit 1 pull-out 25.6 cm 2 doors 51.6 cm 1 adjustable shelf Carcase depth 70.5 cm	PU 80 78 70 90	492	501	532	670	727	766	832	915	-
		PU 90 78 70 90		492	501	532	670	727	766	832	915	-	
		PU 100 78 70 90		500	512	543	686	740	780	850	935	-	
		PU 120 78 70 90		510	524	553	697	752	793	864	950	-	
		Width 80, 100 Not available for: GENT, INTARSIA, OSLO 15, TESSIN 15, TIM 15, VILLAGE 15-B, VILLAGE 15-S Width 90, 120 Not available for: INTARSIA, STRIP ELEMENTS											
R/L	70.5	256 516	Base unit 1 drawer 25.6 cm 1 internal drawer 1 door 51.6 cm 1 adjustable shelf Carcase depth 70.5 cm	PU 30 78 70 901	568	588	626	689	719	742	770	847	-
		PU 40 78 70 901		568	588	626	690	719	744	774	851	-	
		PU 45 78 70 901		568	588	626	690	735	754	784	862	-	
		PU 50 78 70 901		568	588	626	690	735	756	788	867	-	
		PU 60 78 70 901		600	623	668	735	780	808	849	934	-	
R/L	70.5	256 516	Base unit 1 drawer 25.6 cm 1 internal drawer 2 doors 51.6 cm 1 adjustable shelf Carcase depth 70.5 cm	PU 80 78 70 901	699	708	739	877	934	973	1039	1143	-
		PU 90 78 70 901		699	708	739	877	934	973	1039	1143	-	
		PU 100 78 70 901		707	719	749	893	947	987	1057	1163	-	
		PU 120 78 70 901		717	730	760	904	958	1000	1071	1178	-	
		Width 80, 100 Not available for: GENT, INTARSIA, OSLO 15, TESSIN 15, TIM 15, VILLAGE 15-B, VILLAGE 15-S Width 90, 120 Not available for: INTARSIA, STRIP ELEMENTS											
R/L	70.5	256 516	Base unit 1 pull-out 25.6 cm 1 pull-out 51.6 cm 1 internal pull-out Carcase depth 70.5 cm	PU 30 78 70 921	773	783	831	873	873	896	942	1036	-
		PU 40 78 70 921		773	783	831	873	873	896	942	1036	-	
		PU 45 78 70 921		773	783	831	873	873	896	942	1036	-	
		PU 50 78 70 921		773	783	831	873	873	896	942	1036	-	
		PU 60 78 70 921		805	811	861	922	922	947	1002	1102	-	
R/L	70.5	256 516	Base unit 1 drawer 25.6 cm 1 internal drawer 1 pull-out 51.6 cm 1 internal pull-out Carcase depth 70.5 cm	PU 30 78 70 922	1090	1100	1148	1189	1189	1212	1258	1384	-
		PU 40 78 70 922		1090	1100	1148	1189	1189	1212	1258	1384	-	
		PU 45 78 70 922		1090	1100	1148	1189	1189	1212	1258	1384	-	
		PU 50 78 70 922		1090	1100	1148	1189	1189	1212	1258	1384	-	
		PU 60 78 70 922		1120	1128	1178	1239	1239	1264	1319	1451	-	
R/L	70.5	256 516	Base unit 1 pull-out 25.6 cm 1 pull-out 51.6 cm Carcase depth 70.5 cm	PU 30 78 70 902	615	622	674	717	717	738	788	867	-
		PU 40 78 70 902		615	622	674	717	717	738	788	867	-	
		PU 45 78 70 902		615	622	674	717	717	738	788	867	-	
		PU 50 78 70 902		615	622	674	717	717	738	788	867	-	
		PU 60 78 70 902		643	653	701	765	765	793	850	935	-	



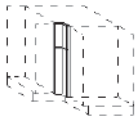

## Background filler 78 cm high

		Order no. W H D		Hinge side:	Carcase depth	Decor groups								
						M10	M20	M30	M40	M50	M60	M70	M80	M90
	<b>Base unit background filler</b> Width: 20 cm For fitting flush with carcass	<b>UPLS 00 78</b>				26,90	28,50	51	68	68	68	68	68	-
	<b>Base unit corner background fillers</b> For corner solution 105 x 105 cm, per item	<b>UWSL 78 1</b>				54	54	69	93	91	93	93	93	-
		 <b>Important!</b> 2 x model required for diagonal corner solution.												
		<b>UM 78</b>				39								
<b>M 10</b> K M10 laminate	<b>M 20</b> D M20 Laminate decor	<b>M 30</b> I M30 RESOPAL PRO super matt IH M30 HPL PRO PW M30 PRIMEWOOD/Basic Veneer	<b>M 40</b> A M40 DIRECTLACK matt L M40 DIRECTLACK high-gloss	<b>M 50</b> B M50 Velvet lacquer P M50 Soft lacquer S M50 microstructure lacquer										
<b>M 60</b> QH M60 SMARTGLAS high-gloss QM M60 SMARTGLAS satin-finish	<b>M 70</b> F M70 veneer / oak / walnut Z M70 Veneer / Bavaria	<b>M 80</b> C1 M80 FENIX stainless-steel look H M80 high gloss-Lacquer MP M80 laqué mat Premium	<b>M 90</b>											

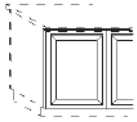

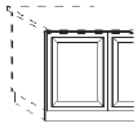

## Front filler 78 cm high

		Order no. W H D		Hinge side:	Carcase depth	Price groups								
						1	2	3	4	5	6	7	8	9
	<b>Base unit front filler divided</b> consisting of one element 25.6 cm and one element 51.6 cm  3.5 - 10 cm 10.1 - 20 cm					 <b>Note:</b> Not available with grip ledges								
		<b>PUPPT 10 78</b>				98	98	106	139	139	139	149	164	-
		<b>PUPPT 20 78</b>				119	119	123	175	175	175	193	212	-


## Corner filler 78 cm high

	<b>Base unit corner filler 90° partitioned by up to 20 x 20 cm</b> consisting of one element 25.6 cm and one element 51.6 cm  9.5 x 9.5 cm up to 20 x 20 cm	 <b>Important!</b> Planning dimensions 65 x 65 cm Items can only be fitted in the ALU TEC RP models with a minimum size of 6 x 6 cm. <b>Note:</b> Not available with grip ledges												
		<b>PUPWT65 78</b>				178	178	209	225	225	225	262	288	-
		<b>PUPWT75 78</b>				195	195	216	247	247	247	321	353	-


## Back cladding 78 cm high with screw-fitted fronts

776 	<b>Back cladding</b> for base units, 78 cm high Carcass material With screw-fitted fronts 77.6 cm only available in grid sizes	per 10 cm Width	<b>UVF 78</b>			38	41	45	64	66	69	75	83	-
		 <b>Important!</b> Observe worktop excess depth 66 cm! The plinth panel required is supplied loose.												
776 	<b>Back cladding</b> for base units, 78 cm high carcase material extends down to floor level With screw-fitted fronts 77.6 cm Only available in grid sizes	per 10 cm Width	<b>UVF 00 78</b>			38	41	45	64	66	69	75	83	-
		 <b>Important!</b> Observe worktop excess depth 66 cm! The plinth panel required is supplied loose.												

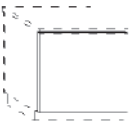

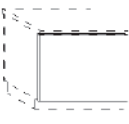

## Support panel 78 cm high

		Order no. W H D		Hinge side:	Carcase depth	Decor groups								
						M10	M20	M30	M40	M50	M60	M70	M80	M90
	<b>Base unit support panel</b> 60 cm deep, 98 cm high without plinth cutout Height to be adapted on site	Unit price				46	147	284	378	378	378	378	378	-
		<b>USW 98 60</b>												

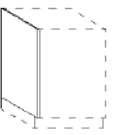

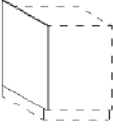

## Support panel 78 cm high

		Order no.		Hinge side:		Decor groups								
		W H D		Carcase depth		M10	M20	M30	M40	M50	M60	M70	M80	M90
	<b>Base unit support panel</b> 90 cm deep, 98 cm high without plinth cutout Height to be adapted on site	Unit price												
		<b>USW 98 90</b>				48	173	317	422	422	422	422	422	-
<b>M 10</b>	<b>M 20</b>	<b>M 30</b>		<b>M 40</b>		<b>M 50</b>								
K M10 laminate	D M20 Laminate decor	I M30 RESOPAL PRO super matt IH M30 HPL PRO PW M30 PRIMEWOOD/Basic Veneer		A M40 DIRECTLACK matt L M40 DIRECTLACK high-gloss		B M50 Velvet lacquer S M50 microstructure lacquer								
<b>M 60</b>	<b>M 70</b>	<b>M 80</b>		<b>M 90</b>										
QH M60 SMARTGLAS high-gloss QM M60 SMARTGLAS satin-finish	F M70 veneer / oak / walnut Z M70 Veneer / Bavaria	C1 M80 FENIX stainless-steel look H M80 high gloss-Lacquer MP M80 laqué mat Premium												

## Back cladding 78 cm high

	<b>Back cladding</b> With suspension fittings for base units, 78 cm high 16 mm thick	per 10 cm Width												
		<b>UVK 78</b>				9,10	15,80	39	51	51	51	51	51	-
 <b>Important!</b> Observe worktop excess depth 64 cm! The plinth panel required is supplied loose.														
	<b>Back cladding</b> With suspension fittings For base units 16 mm thick variable height	per m <sup>2</sup> , W x H												
		<b>UVK 00</b> <b>minimum price</b>				118	200	483	644	644	644	644	644	-
 <b>Important!</b> Observe worktop excess depth 64 cm! The plinth panel required is supplied loose.														
<b>M 10</b>	<b>M 20</b>	<b>M 30</b>		<b>M 40</b>		<b>M 50</b>								
K M10 laminate	D M20 Laminate decor	I M30 RESOPAL PRO super matt IH M30 HPL PRO PW M30 PRIMEWOOD/Basic Veneer		A M40 DIRECTLACK matt L M40 DIRECTLACK high-gloss		B M50 Velvet lacquer S M50 microstructure lacquer								
<b>M 60</b>	<b>M 70</b>	<b>M 80</b>		<b>M 90</b>										
QH M60 SMARTGLAS high-gloss QM M60 SMARTGLAS satin-finish	F M70 veneer / oak / walnut Z M70 Veneer / Bavaria	C1 M80 FENIX stainless-steel look H M80 high gloss-Lacquer MP M80 laqué mat Premium												

## Visible sides / increased side depth 78 cm high

	<b>Base unit visible side</b>  55.5 cm side depth Fixed dimension, not variable 57.5 cm side depth Fixed dimension, not variable 60.5 cm side depth Fixed dimension, not variable 61 cm side depth Fixed dimension, not variable 70.5 cm side depth Fixed dimension, not variable	 <b>Important!</b> Installation instead of a normal unit side. Only available in the listed side depths. For other dimensions, use USVT...												
		<b>USV 78</b>	R/L			0	0	67	67	89	89	112	141	-
		<b>USV 78 5</b>	R/L			0	0	67	67	89	89	112	141	-
		<b>USV 78 6</b>	R/L			0	0	67	67	89	89	112	141	-
		<b>USV 78 6 1</b>	R/L			0	0	67	67	89	89	112	141	-
		<b>USV 78 7</b>	R/L			0	0	67	67	89	89	112	141	-
	<b>Base unit increased side depth</b>  from 61.1 cm up to 90 cm side depth Up to 60.9 cm side depth	 <b>Important!</b> Installation instead of a normal unit side.												
		<b>USVT 78</b>	R/L			73	73	147	147	196	196	244	281	-
		<b>USVT 78 6</b>	R/L			37	37	98	98	130	130	162	207	-
<b>M 10</b>	<b>M 20</b>	<b>M 30</b>		<b>M 40</b>		<b>M 50</b>								
K M10 laminate	D M20 Laminate decor	I M30 RESOPAL PRO super matt IH M30 HPL PRO PW M30 PRIMEWOOD/Basic Veneer		A M40 DIRECTLACK matt L M40 DIRECTLACK high-gloss		B M50 Velvet lacquer P M50 Soft lacquer RH M50 Velvet lacquer wood texture RW M50 Velvet lacquer spackle effect S M50 microstructure lacquer								
<b>M 60</b>	<b>M 70</b>	<b>M 80</b>		<b>M 90</b>										
QH M60 SMARTGLAS high-gloss QM M60 SMARTGLAS satin-finish	F M70 veneer / oak / walnut V M70 Velvet lacquer textured Z M70 Veneer / Bavaria	C1 M80 FENIX stainless-steel look H M80 high gloss-Lacquer MP M80 laqué mat Premium O M80 Veneered												

## Base units 84.5 cm high

# LINE E

# 3.5

Height  
84.5 cm

Base units 84.5 cm high	XL 3.5.1-XL 3.5.8
Base units as pass-throughs 84.5 cm high	XL 3.5.8
Base units with glass door 84.5 cm high neutral	XL 3.5.9
Additional equipment	XL 3.5.9
Oven housings 84.5 cm high	XL 3.5.9
Hob base units 84.5 cm high	XL 3.5.10-XL 3.5.12
Hob base units 84.5 cm high for hob extractors	XL 3.5.12-XL 3.5.13
Sink carcasses 84.5 cm high	XL 3.5.13-XL 3.5.19
Base units 84.5 cm high for water purifying, boiling and chilling systems	XL 3.5.19-XL 3.5.20
Corner base units Sink carcasses 84.5 cm high	XL 3.5.20
Diagonal corner base unit Sink carcasses 84.5 cm high	XL 3.5.20
Fronts for electrical appliances for appliance height 82 cm	XL 3.5.21
Fronts for electrical appliances for appliance height 82 - 87 cm	XL 3.5.21-XL 3.5.22
Corner base units 84.5 cm high variable	XL 3.5.23-XL 3.5.24
Corner base units 84.5 cm high Le Mans	XL 3.5.25
Corner base units as carousel corner unit 84.5 cm high	XL 3.5.26
Diagonal corner base unit 84.5 cm high	XL 3.5.27-XL 3.5.28
Base shelf units 84.5 cm high	XL 3.5.29-XL 3.5.30
Base shelf units 84.5 cm high	XL 3.5.30
Base units 84.5 cm high	XL 3.5.31-XL 3.5.32
Hob base units 84.5 cm high	XL 3.5.32-XL 3.5.34
spacefitter frame 84.5 cm high	XL 3.5.34
Background filler 84.5 cm high	XL 3.5.35
Front filler 84.5 cm high	XL 3.5.35
Corner filler 84.5 cm high	XL 3.5.35-XL 3.5.36
Back cladding 84.5 cm high with screw-fitted fronts	XL 3.5.36
Support panel 84.5 cm high	XL 3.5.36
Back cladding 84.5 cm high	XL 3.5.37
Visible sides / increased side depth 84.5 cm high	XL 3.5.37

### Legend:



Available with grip ledge N...



Not available with grip ledge N...



This symbol indicates which models are available



This symbol indicates which models are not available



wall-mounted units



available depths for wall-mounted units



Planning advice



Merchandise net



Not available with „push-to-open“ fitting



Available carcass depths 34/45.5/55.5/61.0 cm



Available carcass depths 45.5/55.5/61.0 cm



Available carcass depths 55.5/61.0 cm

**Note:**  
base units in 84.5 cm height are not available for these models:  
**MIAMI, VIVA**

Height  
84.5 cm

# The most important base unit models 84.5 cm high

Page XL 3.5.1	Page XL 3.5.1	Page XL 3.5.1	Page XL 3.5.1	Page XL 3.5.1	Page XL 3.5.1	Page XL 3.5.1	Page XL 3.5.1	Page XL 3.5.2
U..855570 Unit widths: 20/25/30/40/ 45/50/60	U..855570 Unit widths: 80/90/100/120	U..855560 Unit widths: 30/40/45/50/60	U..855560 Unit widths: 80/90/100/120	U..855510 Unit widths: 30/40/45/50/60	U..855510 Unit widths: 80/90/100/120	U..855518 Unit widths: 80/90/100/120	U..855512 Unit widths: 30/40/45/50/60 70/80/90/100/120	U..8555120 Unit widths: 30/40/45/50/60 70/80/90/100/120
Page XL 3.5.2	Page XL 3.5.2	Page XL 3.5.2	Page XL 3.5.2	Page XL 3.5.2	Page XL 3.5.2	Page XL 3.5.3	Page XL 3.5.3	Page XL 3.5.3
U..855521 Unit widths: 30/40/45/50/60	U..855522 Unit widths: 30/40/45/50/60 70/80/90/100/120	U..855531 Unit widths: 30/40/45/50/60 70/80/90/100/120	U..855541 Unit widths: 30/40/45/50/60 70/80/90/100/120	U..855503 Unit widths: 30/40/45/50/60 70/80/90/100/120	U..8555031 Unit widths: 30/40/45/50/60 70/80/90/100/120	U..8555032 Unit widths: 30/40/45/50/60 70/80/90/100/120	U..855502 Unit widths: 30/40/45/50/60 70/80/90/100/120	U..8555022 Unit widths: 30/40/45/50/60 70/80/90/100/120
Page XL 3.5.3	Page XL 3.5.3	Page XL 3.5.4	Page XL 3.5.4	Page XL 3.5.4	Page XL 3.5.4	Page XL 3.5.4	Page XL 3.5.4	Page XL 3.5.4
U..8555085 Unit widths: 30/40/45/50/60 70/80/90/100/120	U..8555086 Unit widths: 30/40/45/50/60 70/80/90/100/120	U..855502 Unit widths: 180	U..855561 Unit widths: 30/40/45/50/60	U..855571 Unit widths: 30/40/45/50/60	U..855507 Unit widths: 15/20	U..855509 Unit widths: 15/20	UVP..855507M Unit widths: 30	UVP..855517M Unit widths: 30
Page XL 3.5.5	Page XL 3.5.5	Page XL 3.5.5	Page XL 3.5.5	Page XL 3.5.5	Page XL 3.5.5	Page XL 3.5.5	Page XL 3.5.5	Page XL 3.5.5
U..855507M Unit widths: 30	U..8555071M Unit widths: 30	U..855515 Unit widths: 30/50	U..8555151 Unit widths: 30/50	U..8555152 Unit widths: 30/50	U..855508 Unit widths: 30	U..8555081 Unit widths: 30	U..855506M Unit widths: 30	U..8555061M Unit widths: 30
Page XL 3.5.6	Page XL 3.5.6	Page XL 3.5.6	Page XL 3.5.6	Page XL 3.5.6	Page XL 3.5.6	Page XL 3.5.6	Page XL 3.5.7	Page XL 3.5.7
U..855509 Unit widths: 40	U..855573 Unit widths: 30/40/45/50/60	U..855563 Unit widths: 30/40/45/50/60	U..855513 Unit widths: 30/40/45/50/60	U..855514 Unit widths: 30/40/45/50/60	U..8555141 Unit widths: 30/40/45/50/60	U..855505 Unit widths: 30/45/50/60	U..8555051 Unit widths: 30/45/50/60	U..855594 Unit widths: 45
Page XL 3.5.7	Page XL 3.5.7	Page XL 3.5.7	Page XL 3.5.8	Page XL 3.5.8	Page XL 3.5.8	Page XL 3.5.8	Page XL 3.5.8	Page XL 3.5.8
U..855595 Unit widths: 60	U..8555961 Unit widths: 60	U..8555088 Unit widths: 15/20	UDU..855570 Unit widths: 45/50/60	UDU..855570 Unit widths: 80/90/100/120	UDU..855560 Unit widths: 45/50/60	UDU..855560 Unit widths: 80/90/100/120	UDU..855510 Unit widths: 45/50/60	UDU..855518 Unit widths: 80/90/100/120

# The most important base unit models 84.5 cm high

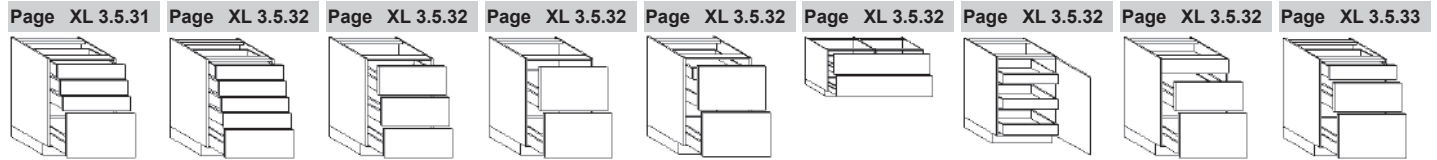
								
Page XL 3.5.9	Page XL 3.5.9	Page XL 3.5.9	Page XL 3.5.9	Page XL 3.5.9	Page XL 3.5.10	Page XL 3.5.10	Page XL 3.5.10	Page XL 3.5.10
UGD..8555 Unit widths: 45/50/60	UH..855510 Unit widths: 60	UH..855512 Unit widths: 60	UH..855584 Unit widths: 60	UM..855583 Unit widths: 60/90	UK..855580 Unit widths: 90/100/120	UKI..855510 Unit widths: 60	UKI..85616 Unit widths: 60	UKI..856161 Unit widths: 60
								
Page XL 3.5.11	Page XL 3.5.11	Page XL 3.5.11	Page XL 3.5.11	Page XL 3.5.11	Page XL 3.5.11	Page XL 3.5.11	Page XL 3.5.11	Page XL 3.5.11
								
UK..855582 Unit widths: 60/70/80/ 90/100/120	UK..8555820 Unit widths: 60/70/80/ 90/100/120	UKI..855512 Unit widths: 60/70/80/ 90/100/120	UKI..855513 Unit widths: 60/70/80/ 90/100/120	UKI..85554 Unit widths: 60/80/90/100/120	UKI..855541 Unit widths: 60/80/90/100/120	UKI..8555120 Unit widths: 60/70/80/ 90/100/120	UKI..8555122 Unit widths: 60/70/80/ 90/100/120	UKI..855540 Unit widths: 60/80/90/100/120
								
Page XL 3.5.12	Page XL 3.5.12	Page XL 3.5.12	Page XL 3.5.12	Page XL 3.5.12	Page XL 3.5.12	Page XL 3.5.12	Page XL 3.5.12	Page XL 3.5.12
								
UKI..855542 Unit widths: 60/80/90/100/120	UKI..855522 Unit widths: 60/70/80/ 90/100/120	UKI..855523 Unit widths: 60/70/80/ 90/100/120	UKI..85555 Unit widths: 60/80/90/100/120	UKI..855551 Unit widths: 60/80/90/100/120	UK..855581 Unit widths: 60/70/80/ 90/100/120	UDK..555028 Unit widths: 70/80/90/100/120	UDK..8555088 Unit widths: 70/80/90/100/120	UDK..855502 Unit widths: 80/90/100/120
								
Page XL 3.5.12	Page XL 3.5.13	Page XL 3.5.13	Page XL 3.5.13	Page XL 3.5.13	Page XL 3.5.13	Page XL 3.5.13	Page XL 3.5.14	Page XL 3.5.14
								
UDK..8555082 Unit widths: 80/90/100/120	UDK..855508 Unit widths: 80/90/100/120	UDK..8555022 Unit widths: 80/90/100/120	UDK..855582 Unit widths: 80/90/100/120	UDK..855581 Unit widths: 80/90/100/120	US..8555701 Unit widths: 40/45/50/60	US..8555702 Unit widths: 30/40/45/50/60	US..8555702 Unit widths: 80/90/100/120	US..8555601 Unit widths: 40/45/50/60
Page XL 3.5.14	Page XL 3.5.14	Page XL 3.5.14	Page XL 3.5.14	Page XL 3.5.14	Page XL 3.5.14	Page XL 3.5.15	Page XL 3.5.15	Page XL 3.5.15
US..8555601 Unit widths: 80/90/100/120	US..8555602 Unit widths: 30/40/45/50/60	US..8555602 Unit widths: 80/90/100/120	US..855513 Unit widths: 80/90/100/120	US..8555026 Unit widths: 70/80/90/100/120	US..8555027 Unit widths: 80/90/100/120	US..8555826 Unit widths: 70/80/90/100/120	US..8555827 Unit widths: 80/90/100/120	US..8555828 Unit widths: 70/80/90/100/120
Page XL 3.5.15	Page XL 3.5.16	Page XL 3.5.16	Page XL 3.5.16	Page XL 3.5.16	Page XL 3.5.16	Page XL 3.5.17	Page XL 3.5.17	Page XL 3.5.17
US..855588 Unit widths: 30/40/45/50/60	US..855588 Unit widths: 30/40/45/50/60	US..855581 Unit widths: 30/40/45/50/60	US..855589 Unit widths: 45/50/60	US..855579 Unit widths: 45/50/60	US..855595 Unit widths: 45/50/60	US..8555951 Unit widths: 45/50/60	US..8555820 Unit widths: 60	US..8555821 Unit widths: 60

# The most important base unit models 84.5 cm high

Page XL 3.5.18	Page XL 3.5.18	Page XL 3.5.18	Page XL 3.5.18	Page XL 3.5.19	Page XL 3.5.19	Page XL 3.5.19	Page XL 3.5.19	Page XL 3.5.19
US.8555021 Unit widths: 60	US.8555882 Unit widths: 60	US..8555882 Unit widths: 80/90/100/120	US..855593 Unit widths: 60	US..855596 Unit widths: 60	US..8555961 Unit widths: 60	US..8555721 Unit widths: 40/45/50/60	US..8555721 Unit widths: 80/90/100/120	UWS..855570 Unit widths: 45/60
Page XL 3.5.20	Page XL 3.5.20	Page XL 3.5.20	Page XL 3.5.20	Page XL 3.5.20	Page XL 3.5.20	Page XL 3.5.23	Page XL 3.5.23	Page XL 3.5.23
USE..85557 Unit widths: 105/110/115/125	USE..85558 Unit widths: 105/110/115/125	USD..8580 Unit widths: 90x90	USD..8570 Unit widths: 90x90	USD..8580 Unit widths: 105x105	USD..8570 Unit widths: 105x105	UE..855510 Unit widths: 105/110/115/125	UE..855570 Unit widths: 105/110/115/125	UE..855560 Unit widths: 105/110/115/125
Page XL 3.5.23	Page XL 3.5.23	Page XL 3.5.24	Page XL 3.5.24	Page XL 3.5.25	Page XL 3.5.25	Page XL 3.5.25	Page XL 3.5.25	Page XL 3.5.26
UE..855512 Unit widths: 110/115/125	UE..855513 Unit widths: 110/115/125	UE..855573 Unit widths: 110/115/125	UE..855563 Unit widths: 110/115/125	UE..855564 Unit widths: 110/115/125	UE..855574 Unit widths: 110/115/125	UE..855514 Unit widths: 110/115/125	UE..8555742 Unit widths: 110/115/125	UEB..8570 Unit widths: 90x90
Page XL 3.5.26	Page XL 3.5.26	Page XL 3.5.26	Page XL 3.5.26	Page XL 3.5.26	Page XL 3.5.27	Page XL 3.5.27	Page XL 3.5.27	Page XL 3.5.27
UEB..8560 Unit widths: 90x90	UEK..8573 Unit widths: 80x80	UEK..8572 Unit widths: 80x80	UEK..8563 Unit widths: 90x90	UEK..8562 Unit widths: 90x90	UED..8560 Unit widths: 90x90/105x105	UED..8570 Unit widths: 90x90/105x105	UED..8562 Unit widths: 90x90/105x105	UED..8572 Unit widths: 90x90/105x105
Page XL 3.5.27	Page XL 3.5.27	Page XL 3.5.29	Page XL 3.5.29	Page XL 3.5.29	Page XL 3.5.29	Page XL 3.5.29	Page XL 3.5.29	Page XL 3.5.30
UED..8563 Unit widths: 90x90/105x105	UED..8573 Unit widths: 90x90/105x105	UR..8558 Unit widths: 30/40/45/50/60	URFL..8558 Unit widths: 15/30	URH..8558 Unit widths: 15/20/25	URS..8558 Unit widths: 15-60	URA..8558 Unit widths: 25	URSK..8558 Unit widths: 15	URIF..8558IA3K Unit widths: 45/60/90
Page XL 3.5.30	Page XL 3.5.31	Page XL 3.5.31	Page XL 3.5.31	Page XL 3.5.31	Page XL 3.5.31	Page XL 3.5.31	Page XL 3.5.31	Page XL 3.5.31
URIF..8558IS4K Unit widths: 45/60/90	U..8570085 Unit widths: 30/40/45/50/60 70/80/90/100	U..8570086 Unit widths: 30/40/45/50/60 70/80/90/100	U..857070 Unit widths: 30/40/45/50/60	U..857070 Unit widths: 80/90/100/120	U..857010 Unit widths: 30/40/45/50/60	U..857010 Unit widths: 80/90/100/120	U..857012 Unit widths: 30/40/45/50/60 70/80/90/100	U..857022 Unit widths: 30/40/45/50/60 70/80/90/100/120



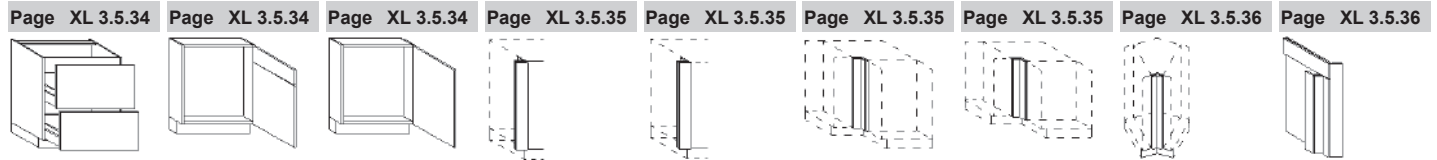
# The most important base unit models 84.5 cm high



<b>U..857031</b>	<b>U..857041</b>	<b>U..857003</b>	<b>U..857002</b>	<b>U..8570022</b>	<b>U..857002</b>	<b>U..857073</b>	<b>UK..857082</b>	<b>UKI..857012</b>
<b>Unit widths:</b> 30/40/45/50/60 70/80/90/100	<b>Unit widths:</b> 30/40/45/50/60 70/80/90/100/120	<b>Unit widths:</b> 30/40/45/50/60 70/80/90/100/120	<b>Unit widths:</b> 30/40/45/50/60 70/80/90/100	<b>Unit widths:</b> 30/40/45/50/60 70/80/90/100	<b>Unit widths:</b> 180	<b>Unit widths:</b> 30/40/45/50/60	<b>Unit widths:</b> 60/80/90/100	<b>Unit widths:</b> 60/70/80/90/100

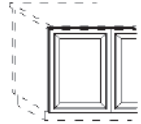


<b>UKI..857022</b>	<b>UK..857081</b>	<b>UDK..857002</b>	<b>UDK..8570082</b>	<b>UDK..8570028</b>	<b>UDK..8570088</b>	<b>UDK..857082</b>	<b>UDK..857081</b>	<b>UDK..8570082</b>
<b>Unit widths:</b> 70/80/90/100/120	<b>Unit widths:</b> 70/80/90/100/120	<b>Unit widths:</b> 80/90/100	<b>Unit widths:</b> 80/90/100	<b>Unit widths:</b> 80/90/100	<b>Unit widths:</b> 70/80/90/100	<b>Unit widths:</b> 70/80/90/100	<b>Unit widths:</b> 80/90/100/120	<b>Unit widths:</b> 80/90/100



<b>UDK..857008</b>	<b>UPR..851060</b>	<b>UPR..851070</b>	<b>UP..85</b>	<b>UPA..85</b>	<b>UPW..85</b>	<b>UPWN..85</b>	<b>UPW..85</b>	<b>UPH..8578</b>
<b>Unit widths:</b> 80/90/100	<b>Unit widths:</b> 30/40/45/50/60	<b>Unit widths:</b> 20/25/30/ 40/45/50/60	<b>Unit widths:</b> 3,5-20	<b>Unit widths:</b> 10-20	<b>Unit widths:</b> 65x65/75x75	<b>Unit widths:</b> 65x65/75x75	<b>Unit widths:</b> 105x105	<b>Unit widths:</b> 9,5x9,5

Page XL 3.5.36



**UVF85**

**Unit widths:**

**Base units 84.5 cm high**  
 Carcase depth 55.5 cm (standard)

■ = Models also available in 34/45.5/61 cm carcase depth (Order no.: ... replace ... 55 ... with 34/45/61)  
 □ = Models also available in 45.5/61 cm carcase depth (order no.: replace ... 55 ... with 45/61)  
 ▲ = Types also available with 61 cm carcase depth (order no.: ... replace ... 55 ... with 61)

# LINE E

Order no.	W	H	D	Hinge side:	Carcase depth	Price groups												
						1	2	3	4	5	6	7	8	9				
841	34,0 45,5 55,5 61,0	■	U	R/L	■	20	85	55	70	188	196	222	272	294	307	339	373	-
						25	85	55	70	188	196	222	272	294	307	339	373	-
						30	85	55	70	188	196	222	272	294	307	339	373	-
						40	85	55	70	188	196	222	279	294	312	342	376	-
						45	85	55	70	188	196	222	279	294	312	342	376	-
						50	85	55	70	188	196	222	279	312	335	374	411	-
						60	85	55	70	223	233	253	319	365	390	431	474	-
width 20 cm: <i>FRAME, VILLAGE 15-S, VILLAGE 15-B, CHALET-S, CHALET-B, OSLO 15, TESSIN 15, BERGEN, LUGANO, CASTELLO, VIVA, TIM 15</i> are supplied with smooth fronts. width 25 cm: <i>FRAME</i> are supplied with smooth fronts.																		
841	34,0 45,5 55,5 61,0	■	SE	R/L	■	60	85	55	70	-	-	-	-	-	-	-	-	1141
						Available for: STRIP ELEMENTS Available finishes: 775 Ash black lacquered												
841	34,0 45,5 55,5 61,0	■	U	■	80	85	55	70	251	261	292	419	505	548	617	679	-	
					90	85	55	70	251	261	292	419	505	548	618	680	-	
					100	85	55	70	263	275	308	442	505	548	619	681	-	
					120	85	55	70	303	322	370	524	598	647	728	801	-	
126 711	34,0 45,5 55,5 61,0	■	U	R/L	■	30	85	55	60	188	196	222	272	294	307	339	373	-
						40	85	55	60	188	196	222	279	294	312	342	376	-
						45	85	55	60	188	196	222	279	294	312	342	376	-
						50	85	55	60	188	196	222	279	312	335	374	411	-
						60	85	55	60	223	233	253	319	365	390	431	474	-
126 711	34,0 45,5 55,5 61,0	■	U	■	80	85	55	60	251	261	292	419	505	548	617	679	-	
					90	85	55	60	251	261	292	419	505	548	618	680	-	
					100	85	55	60	263	275	308	442	505	548	619	681	-	
					120	85	55	60	303	322	370	524	598	647	728	801	-	
126 711	34,0 45,5 55,5 61,0	■	U	R/L	■	30	85	55	10	235	244	270	333	351	373	404	444	-
						40	85	55	10	235	244	270	334	351	375	410	451	-
						45	85	55	10	235	244	270	334	367	385	420	462	-
						50	85	55	10	235	244	270	334	367	387	423	465	-
						60	85	55	10	269	279	312	379	414	440	487	536	-
126 711	34,0 45,5 55,5 61,0	■	U	■	80	85	55	10	329	339	371	512	572	613	681	749	-	
					90	85	55	10	329	339	371	512	572	613	681	749	-	
					100	85	55	10	338	350	383	530	584	625	697	767	-	
					120	85	55	10	348	361	393	542	597	640	712	783	-	
Width 80, 100 Not available for: <i>GENT, INTARSIA, OSLO 15, TESSIN 15, TIM 15, VILLAGE 15-B, VILLAGE 15-S</i> Width 90, 120 Not available for: <i>INTARSIA</i>																		
126 711	34,0 45,5 55,5 61,0	■	U	■	80	85	55	18	361	375	396	543	603	642	712	783	-	
					90	85	55	18	361	375	401	546	603	642	713	784	-	
					100	85	55	18	376	387	419	566	603	642	714	785	-	
					120	85	55	18	420	440	479	650	705	754	837	921	-	
126 321 386	34,0 45,5 55,5 61,0	■	U	■	30	85	55	12	481	493	542	594	594	619	672	739	-	
					40	85	55	12	481	493	542	594	594	619	672	739	-	
					45	85	55	12	481	493	542	594	594	619	672	739	-	
					50	85	55	12	481	493	542	594	594	619	672	739	-	
					60	85	55	12	514	530	575	646	646	677	735	809	-	
					80	85	55	12	805	818	907	993	1010	1062	1167	1284	-	
					70	85	55	12	805	818	907	993	1010	1062	1167	1284	-	
					90	85	55	12	807	823	909	999	1012	1064	1170	1287	-	
					100	85	55	12	831	850	943	1036	1049	1109	1212	1333	-	
					120	85	55	12	859	880	978	1071	1090	1150	1264	1390	-	

# Base units 84.5 cm high

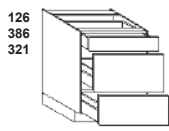
Carcase depth 55.5 cm (standard)

- = Models also available in 34/45.5/61 cm carcass depth (Order no.: ... replace ... 55 ... with 34/45/61)
- = Models also available in 45.5/61 cm carcass depth (order no.: replace ... 55 ... with 45/61)
- ▲ = Types also available with 61 cm carcass depth (order no. ... replace ... 55 ... with 61)

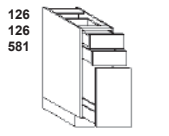
# LINE E

Order no.  
W H D

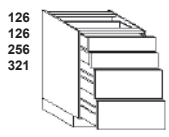
Hinge side:	Carcass depth	Price groups									
		1	2	3	4	5	6	7	8	9	
34 45.5 55.5 61.0	■	U 30 85 55 120	481	493	542	594	594	619	672	739	-
		U 40 85 55 120	481	493	542	594	594	619	672	739	-
		U 45 85 55 120	481	493	542	594	594	619	672	739	-
		U 50 85 55 120	481	493	542	594	594	619	672	739	-
		U 60 85 55 120	514	530	575	646	646	677	735	809	-
		U 80 85 55 120	805	818	907	993	1010	1062	1167	1284	-
		U 70 85 55 120	805	818	907	993	1010	1062	1167	1284	-
		U 90 85 55 120	807	823	909	999	1012	1064	1170	1287	-
		U 100 85 55 120	831	850	943	1036	1049	1109	1212	1333	-
		U 120 85 55 120	859	880	978	1071	1090	1150	1264	1390	-
34 45.5 55.5 61.0	■	U 30 85 55 21	481	493	542	594	594	619	672	739	-
		U 40 85 55 21	481	493	542	594	594	619	672	739	-
		U 45 85 55 21	481	493	542	594	594	619	672	739	-
		U 50 85 55 21	481	493	542	594	594	619	672	739	-
		U 60 85 55 21	514	530	575	646	646	677	735	809	-
34 45.5 55.5 61.0	■	U 30 85 55 22	588	597	649	699	699	723	774	851	-
		U 40 85 55 22	588	597	649	699	699	723	774	851	-
		U 45 85 55 22	588	597	649	699	699	723	774	851	-
		U 50 85 55 22	588	597	649	699	699	723	774	851	-
		U 60 85 55 22	622	632	679	750	750	780	837	921	-
		U 70 85 55 22	909	925	1010	1100	1113	1168	1269	1396	-
		U 80 85 55 22	909	925	1010	1100	1113	1168	1269	1396	-
		U 90 85 55 22	909	925	1010	1100	1113	1168	1269	1396	-
		U 100 85 55 22	947	966	1059	1150	1166	1225	1331	1464	-
		U 120 85 55 22	982	1005	1108	1203	1214	1283	1395	1535	-
34 45.5 55.5 61.0	■	U 30 85 55 31	481	495	511	586	605	630	672	739	-
		U 40 85 55 31	481	495	511	586	605	630	672	739	-
		U 45 85 55 31	481	495	511	586	605	630	672	739	-
		U 50 85 55 31	481	495	511	586	605	630	672	739	-
		U 60 85 55 31	499	508	532	618	635	666	709	780	-
		U 70 85 55 31	870	885	972	1058	1071	1127	1227	1350	-
		U 80 85 55 31	870	885	972	1058	1071	1127	1227	1350	-
		U 90 85 55 31	870	885	972	1058	1071	1127	1227	1350	-
		U 100 85 55 31	905	925	1014	1111	1124	1185	1290	1419	-
		U 120 85 55 31	939	968	1062	1163	1177	1243	1355	1491	-
34 45.5 55.5 61.0	■	U 30 85 55 41	588	599	621	694	712	735	774	851	-
		U 40 85 55 41	588	599	621	694	712	735	774	851	-
		U 45 85 55 41	588	599	621	694	712	735	774	851	-
		U 50 85 55 41	588	599	621	694	712	735	774	851	-
		U 60 85 55 41	605	617	638	722	740	772	814	895	-
		U 70 85 55 41	961	977	1061	1142	1161	1211	1315	1447	-
		U 80 85 55 41	961	977	1061	1142	1161	1211	1315	1447	-
		U 90 85 55 41	961	977	1061	1142	1161	1211	1315	1447	-
		U 100 85 55 41	1005	1032	1124	1208	1225	1284	1392	1531	-
		U 120 85 55 41	1050	1081	1183	1275	1289	1356	1471	1618	-
34 45.5 55.5 61.0	■	U 30 85 55 03	532	538	586	640	640	664	716	788	-
		U 40 85 55 03	532	538	586	640	640	664	716	788	-
		U 45 85 55 03	532	538	586	640	640	664	716	788	-
		U 50 85 55 03	532	538	586	640	640	664	716	788	-
		U 60 85 55 03	561	572	618	688	688	721	778	856	-
		U 70 85 55 03	850	865	954	1042	1056	1110	1209	1330	-
		U 80 85 55 03	850	865	954	1042	1056	1110	1209	1330	-
		U 90 85 55 03	850	865	954	1042	1056	1110	1209	1330	-
		U 100 85 55 03	877	896	991	1079	1095	1151	1258	1384	-
		U 120 85 55 03	905	926	1025	1118	1131	1196	1307	1438	-
34 45.5 55.5 61.0	■	U 30 85 55 031	604	616	668	712	720	742	789	868	-
		U 40 85 55 031	604	616	668	712	720	742	789	868	-
		U 45 85 55 031	604	616	668	712	720	742	789	868	-
		U 50 85 55 031	604	616	668	712	720	742	789	868	-
		U 60 85 55 031	648	661	709	725	731	755	801	881	-
		U 70 85 55 031	953	971	1061	1141	1163	1214	1311	1442	-
		U 80 85 55 031	953	971	1061	1141	1163	1214	1311	1442	-
		U 90 85 55 031	953	971	1061	1141	1163	1214	1311	1442	-
		U 100 85 55 031	992	1011	1110	1193	1212	1269	1370	1507	-
		U 120 85 55 031	1021	1048	1151	1235	1255	1318	1423	1565	-



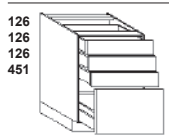
**Base unit**  
1 drawer 12.6 cm  
1 pull-out 38.6 cm  
1 pull-out 32.1 cm



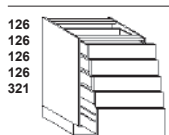
**Base unit**  
2 drawers 12.6 cm  
1 pull-out 58.1 cm



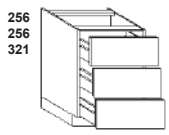
**Base unit**  
2 drawers 12.6 cm  
1 pull-out 25.6 cm  
1 pull-out 32.1 cm



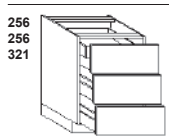
**Base unit**  
3 drawers 12.6 cm  
1 pull-out 45.1 cm



**Base unit**  
4 drawers 12.6 cm  
1 pull-out 32.1 cm



**Base unit**  
2 pull-outs 25.6 cm  
1 pull-out 32.1 cm



**Base unit**  
1 drawer 25.6 cm  
1 internal drawer  
1 pull-out 25.6 cm  
1 pull-out 32.1 cm

**Base units 84.5 cm high**  
Carcase depth 55.5 cm (standard)

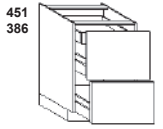
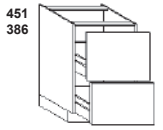
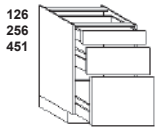
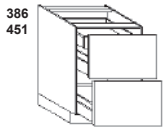
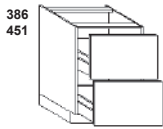
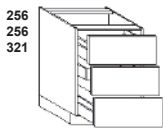
# LINE E

## Price groups

■ = Models also available in 34/45.5/61 cm carcass depth (Order no.: ... replace ... 55 ... with 34/45/61)  
□ = Models also available in 45.5/61 cm carcass depth (order no.: replace ... 55 ... with 45/61)  
▲ = Types also available with 61 cm carcass depth (order no.: ... replace ... 55 ... with 61)

Order no.  
W H D

Hinge side:	Carcass depth	Price groups									
		1	2	3	4	5	6	7	8	9	
■	34,0 45,5 55,5 61,0	U 30 85 55 032	604	616	668	712	720	742	789	868	-
		U 40 85 55 032	604	616	668	712	720	742	789	868	-
		U 45 85 55 032	604	616	668	712	720	742	789	868	-
		U 50 85 55 032	604	616	668	712	720	742	789	868	-
		U 60 85 55 032	648	661	709	725	731	755	801	881	-
		U 70 85 55 032	953	971	1061	1141	1163	1214	1311	1442	-
		U 80 85 55 032	953	971	1061	1141	1163	1214	1311	1442	-
		U 90 85 55 032	953	971	1061	1141	1163	1214	1311	1442	-
		U 100 85 55 032	992	1011	1110	1193	1212	1269	1370	1507	-
		U 120 85 55 032	1021	1048	1151	1235	1255	1318	1423	1565	-
■	34,0 45,5 55,5 61,0	U 30 85 55 02	448	458	507	561	561	584	638	702	-
		U 40 85 55 02	448	458	507	561	561	584	638	702	-
		U 45 85 55 02	448	458	507	561	561	584	638	702	-
		U 50 85 55 02	448	458	507	561	561	584	638	702	-
		U 60 85 55 02	481	494	540	615	615	642	701	771	-
		U 70 85 55 02	770	787	876	965	978	1035	1133	1246	-
		U 80 85 55 02	770	787	876	965	978	1035	1133	1246	-
		U 90 85 55 02	770	787	876	965	978	1035	1133	1246	-
		U 100 85 55 02	790	807	898	990	1005	1060	1167	1284	-
		U 120 85 55 02	□	807	828	921	1014	1035	1092	1199	1319
■	34,0 45,5 55,5 61,0	U 30 85 55 022	557	565	616	668	668	690	743	817	-
		U 40 85 55 022	564	572	621	674	674	697	750	825	-
		U 45 85 55 022	565	573	622	675	675	699	752	827	-
		U 50 85 55 022	566	575	625	676	676	701	754	829	-
		U 60 85 55 022	616	626	672	742	742	772	829	912	-
		U 70 85 55 022	880	894	979	1064	1078	1128	1229	1352	-
		U 80 85 55 022	880	894	979	1064	1078	1128	1229	1352	-
		U 90 85 55 022	884	897	983	1068	1081	1132	1232	1355	-
		U 100 85 55 022	908	925	1014	1100	1115	1170	1271	1398	-
		U 120 85 55 022	□	959	977	1072	1159	1174	1232	1336	1470
■	34,0 45,5 55,5 61,0	U 30 85 55 180	481	493	542	594	594	619	672	739	-
		U 40 85 55 180	481	493	542	594	594	619	672	739	-
		U 45 85 55 180	481	493	542	594	594	619	672	739	-
		U 50 85 55 180	481	493	542	594	594	619	672	739	-
		U 60 85 55 180	514	530	575	646	646	677	735	809	-
		U 70 85 55 180	805	818	907	993	1010	1062	1167	1284	-
		U 80 85 55 180	805	818	907	993	1010	1062	1167	1284	-
		U 90 85 55 180	807	823	909	999	1012	1064	1170	1287	-
		U 100 85 55 180	831	850	943	1036	1049	1109	1212	1333	-
		U 120 85 55 180	□	859	880	978	1071	1090	1150	1264	1390
■	34,0 45,5 55,5 61,0	U 30 85 55 085	448	458	507	561	561	584	638	702	-
		U 40 85 55 085	448	458	507	561	561	584	638	702	-
		U 45 85 55 085	448	458	507	561	561	584	638	702	-
		U 50 85 55 085	448	458	507	561	561	584	638	702	-
		U 60 85 55 085	481	494	540	615	615	642	701	771	-
		U 70 85 55 085	770	787	876	965	978	1035	1133	1246	-
		U 80 85 55 085	770	787	876	965	978	1035	1133	1246	-
		U 90 85 55 085	770	787	876	965	978	1035	1133	1246	-
		U 100 85 55 085	790	807	898	990	1005	1060	1167	1284	-
		U 120 85 55 085	□	807	828	921	1014	1035	1092	1199	1319
■	34,0 45,5 55,5 61,0	U 30 85 55 086	557	565	616	668	668	690	743	817	-
		U 40 85 55 086	564	572	621	674	674	697	750	825	-
		U 45 85 55 086	565	573	622	675	675	699	752	827	-
		U 50 85 55 086	566	575	625	676	676	701	754	829	-
		U 60 85 55 086	616	626	672	742	742	772	829	912	-
		U 70 85 55 086	880	894	979	1064	1078	1128	1229	1352	-
		U 80 85 55 086	880	894	979	1064	1078	1128	1229	1352	-
		U 90 85 55 086	884	897	983	1068	1081	1132	1232	1355	-
		U 100 85 55 086	908	925	1014	1100	1115	1170	1271	1398	-
		U 120 85 55 086	□	959	977	1072	1159	1174	1232	1336	1470



# Base units 84.5 cm high

Carcase depth 55.5 cm (standard)

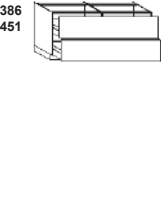
# LINE E

## Price groups

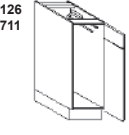
- = Models also available in 34/45.5/61 cm carcass depth (Order no.: ... replace ... 55 ... with 34/45/61)
- = Models also available in 45.5/61 cm carcass depth (order no.: replace ... 55 ... with 45/61)
- ▲ = Types also available with 61 cm carcass depth (order no. ... replace ... 55 ... with 61)

Order no.  
W H D

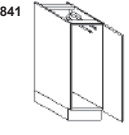
Hinge side:	Carcass depth	Price groups									
		1	2	3	4	5	6	7	8	9	
■	■	U 180 85 55 02	1621	1650	1839	2024	2057	2168	2384	2622	-
<b>Not available for:</b> ALU TEC RP, ALUELEMENTS, ATLANTA-B, ATLANTA-S, BERGEN, CASTELLO, CHALET-B, CHALET-S, CHICAGO, FENIX INOX, FRAME, HPL PRO, INTARSIA, LUGANO, LUX-B, MIAMI, MONTANA, MPX, NEVADA, NOBEL-B, NOBEL-S, ORLANDO-B, ORLANDO-S, PUR, RESOPAL PRO, RESOPAL PRO EDGE, RUSTY OAK, SMART-M, SOFIE-B, SOFIE-S, STRIP ELEMENTS, TALEA, TESSIN 15, TIM, TIM 15, VINO, VIVA, YORK-B, YORK-S  <b>Available handles:</b> from a drilling distance of 128 mm <b>Not available with TIP-ON Blumotion</b>											
		U 30 85 55 61	R/L ▲ 210	223	244	307	314	332	369	406	-
		U 30 85 55 71	R/L ▲ 210	223	244	307	314	332	369	406	-
		U 15 85 55 07	▲ 308	317	342	410	431	448	483	531	-
<b>Not available for:</b> MIAMI, VIVA  <b>Available frame fronts are supplied with smooth fronts.</b> <b>Most handles arranged vertically!</b>											
		TRB15-3		15							
		U 20 85 55 07	▲ 308	317	342	410	431	448	483	531	-
<b>Not available for:</b> BERGEN, LUGANO  <b>Note: pull-out as for unit in 15 cm width (U 15 85 55 07)</b> <b>Most handles arranged vertically!</b>											
		TRB15-3		15							
		U 15 85 55 09	▲ 323	332	359	423	448	461	495	545	-
<b>Not available for:</b> MIAMI, VIVA  <b>Available frame fronts are supplied with smooth fronts.</b> <b>Most handles arranged vertically!</b>											
		U 20 85 55 09	▲ 323	332	359	423	448	461	495	545	-
<b>Not available for:</b> BERGEN, LUGANO  <b>Note: pull-out as for unit in 15 cm width (U 15 85 55 09)</b> <b>Most handles arranged vertically!</b>											
		U 20 85 55 04	▲ 374	383	408	476	497	514	549	604	-
<b>Not available with TIP-ON</b>											
		UVP 30 85 55 07M	▲ 640	650	673	716	735	750	782	860	-
		UVP 30 85 55 17M	▲ 640	650	673	716	735	750	782	860	-



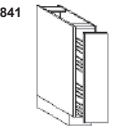
**Base unit**  
 consisting of:  
 2 x 90 cm wide carcasses  
 each with 2 pull-outs  
 Overall carcass width 180 cm  
 1 full-width panel 38.6 cm high  
 and 179.6 cm wide  
 1 full-width panel 45.1 cm high  
 and 179.6 cm wide



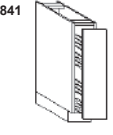
**Base unit**  
 1 panel 12.6 cm attached to  
 1 door 71.1 cm connected  
 1 towel rail, 2-part



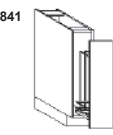
**Base unit**  
 1 door 84.1 cm  
 1 towel rail, 2-part



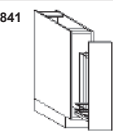
**Base unit**  
 1 pull-out 84.1 cm  
 2 fixed-position baskets with metal base  
 and chrome-plated, square-section rail



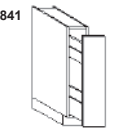
**Base unit**  
 1 pull-out 84.1 cm  
 2 fixed-position baskets with metal base  
 and chrome-plated, square-section rail



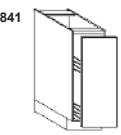
**Base unit**  
 1 pull-out 84.1 cm  
 with 1 towel rail  
 and 1 basket (chrome-plated)



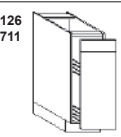
**Base unit**  
 1 pull-out 84.1 cm  
 with 1 towel rail  
 and 1 basket (chrome-plated)



**Base unit**  
 1 pull-out and 1 drawer  
 with front panel 84.1 cm



**Base unit**  
 1 pull-out 84.1 cm  
 With 2 adjustable wooden shelves  
 with chrome-plated square rail



**Base unit**  
 1 panel 12.6 cm attached to  
 1 door 71.1 cm connected  
 With 2 adjustable wooden shelves  
 with chrome-plated square rail

# Base units 84.5 cm high

Carcase depth 55.5 cm (standard)

# LINE E

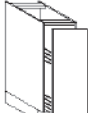
## Price groups

- = Models also available in 34/45.5/61 cm carcass depth (Order no.: ... replace ... 55 ... with 34/45/61)
- = Models also available in 45.5/61 cm carcass depth (order no.: replace ... 55 ... with 45/61)
- ▲ = Types also available with 61 cm carcass depth (order no.: ... replace ... 55 ... with 61)

Order no.  
W H D

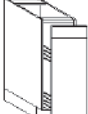
Hinge side:	Carcass depth	Price groups								
		1	2	3	4	5	6	7	8	9
▲	510	522	545	589	612	624	657	723	-	
▲	510	522	545	589	612	624	657	723	-	
▲	335	341	373	438	462	482	512	563	-	
▲	373	381	410	487	500	530	566	623	-	
▲	491	499	525	603	618	646	685	754	-	
▲	443	449	481	548	571	589	622	684	-	
▲	493	499	532	596	620	640	671	738	-	
▲	546	553	580	657	672	701	739	813	-	
▲	646	657	679	723	742	758	788	867	-	
▲	646	657	679	723	742	758	788	867	-	
▲	583	595	618	663	682	696	727	800	-	
▲	583	595	618	663	682	696	727	800	-	

**841 Base unit**  
1 pull-out 84.1 cm with  
2 adjustable wire baskets (chrome-plated)



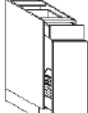
PTO

**126 711 Base unit**  
1 panel 12.6 cm attached to  
1 door 71.1 cm connected  
With 2 adjustable wire baskets (chrome-plated)



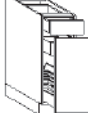
PTO

**126 711 Base unit bottle pull-out**  
1 drawer 12.6 cm  
1 pull-out 71.1 cm with  
1 bottle basket (chrome-plated)  
(with 50 cm width 2 bottle baskets)



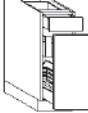
PTO

**126 711 Base unit bottle pull-out**  
1 drawer 12.6 cm  
1 internal drawer  
1 pull-out 71.1 cm with  
1 bottle basket (chrome-plated)  
(with 50 cm width 2 bottle baskets)



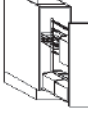
PTO

**126 711 Base unit bottle pull-out**  
1 drawer 12.6 cm  
1 internal pull-out  
1 pull-out 71.1 cm with  
1 bottle basket (chrome-plated)  
(with 50 cm width 2 bottle baskets)



PTO


**841 Base unit**  
1 pull-out 84.1 cm with cookingAGENT  
consisting of:  
1 bottle holder with robust anti-tilting safety  
device  
2 plastic containers  
1 kitchen tool holder  
2 hook-in modules  
1 cutlery holder  
1 knife block with plastic slats



PTO

Note:  
May not be planned directly against a wall.

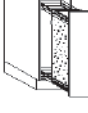
**126 711 Base unit**  
1 panel 12.6 cm attached to  
1 front 71.1 cm  
with cookingAGENT  
consisting of:  
1 bottle holder with robust anti-tilting safety  
device  
2 plastic containers  
1 kitchen tool holder  
2 hook-in modules  
1 cutlery holder  
1 knife block with plastic slats



PTO

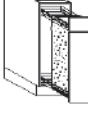
Note:  
May not be planned directly against a wall.

**841 Base unit with bread bag**  
1 pull-out 84.1 cm with  
2 adjustable wire baskets (chrome-plated),  
1 bread bag  
lower wire basket full depth,  
the upper two wire baskets  
with cut out for the bread bag



PTO

**126 711 Base unit with bread bag**  
1 panel 12.6 cm attached to  
1 front 71.1 cm  
With 2 adjustable wire baskets (chrome-plated)  
1 bread bag  
lower wire basket full depth,  
the upper two wire baskets  
with cut out for the bread bag



PTO



# Base units 84.5 cm high

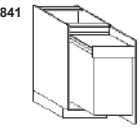
Carcase depth 55.5 cm (standard)

- = Models also available in 34/45.5/61 cm carcass depth (Order no.: ... replace ... 55 ... with 34/45/61)
- = Models also available in 45.5/61 cm carcass depth (order no.: replace ... 55 ... with 45/61)
- ▲ = Types also available with 61 cm carcass depth (order no. ... replace ... 55 ... with 61)

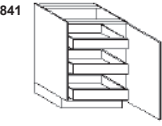
# LINE E

Order no.  
W H D

Hinge side:	Carcass depth	Price groups									
		1	2	3	4	5	6	7	8	9	
R/L ▲	▲	U 40 85 55 09	464	474	498	557	570	588	620	682	-
R/L ■	■	U 30 85 55 73	460	466	493	566	580	606	644	708	-
		U 40 85 55 73	460	466	493	566	580	606	644	708	-
		U 45 85 55 73	460	466	493	566	580	606	644	708	-
		U 50 85 55 73	460	466	493	566	580	606	644	708	-
		U 60 85 55 73	491	501	532	606	626	655	695	765	-
		<p><b>Note:</b></p> <p>Doors with wide angle hinges may not be planned alongside units or panels if the protrusion to the front of the adjoining article is greater than 3 cm (hinge side). Doors with wide angle hinges protrude over the carcass side.</p>									
R/L ■	■	U 30 85 55 63	460	466	493	566	580	606	644	708	-
		U 40 85 55 63	460	466	493	566	580	606	644	708	-
		U 45 85 55 63	460	466	493	566	580	606	644	708	-
		U 50 85 55 63	460	466	493	566	580	606	644	708	-
		U 60 85 55 63	491	501	532	606	626	655	695	765	-
		<p><b>Note:</b></p> <p>Doors with wide angle hinges may not be planned alongside units or panels if the protrusion to the front of the adjoining article is greater than 3 cm (hinge side). Doors with wide angle hinges protrude over the carcass side.</p>									
R/L ■	■	U 30 85 55 13	507	513	540	616	630	652	691	760	-
		U 40 85 55 13	507	513	540	616	630	652	691	760	-
		U 45 85 55 13	507	513	540	616	630	652	691	760	-
		U 50 85 55 13	507	513	540	616	630	652	691	760	-
		U 60 85 55 13	538	549	579	652	675	703	742	816	-
		<p><b>Note:</b></p> <p>Doors with wide angle hinges may not be planned alongside units or panels if the protrusion to the front of the adjoining article is greater than 3 cm (hinge side). Doors with wide angle hinges protrude over the carcass side.</p>									
R/L ■	■	U 30 85 55 14	435	446	473	548	566	586	624	686	-
		U 40 85 55 14	435	446	473	548	566	586	624	686	-
		U 45 85 55 14	435	446	473	548	566	586	624	686	-
		U 50 85 55 14	435	446	473	548	566	586	624	686	-
		U 60 85 55 14	466	485	511	584	602	632	674	741	-
		<p><b>Note:</b></p> <p>Doors with wide angle hinges may not be planned alongside units or panels if the protrusion to the front of the adjoining article is greater than 3 cm (hinge side). Doors with wide angle hinges protrude over the carcass side.</p>									
R/L ■	■	U 30 85 55 141	485	495	518	595	616	633	672	739	-
		U 40 85 55 141	489	499	524	598	619	638	675	743	-
		U 45 85 55 141	490	500	525	599	620	640	676	744	-
		U 50 85 55 141	491	501	528	602	621	641	677	745	-
		U 60 85 55 141	519	540	566	638	655	687	727	800	-
		<p><b>Note:</b></p> <p>Doors with wide angle hinges may not be planned alongside units or panels if the protrusion to the front of the adjoining article is greater than 3 cm (hinge side). Doors with wide angle hinges protrude over the carcass side.</p>									
R/L ▲	▲	U 30 85 55 05	699	707	760	807	807	831	884	972	-
		U 45 85 55 05	699	707	760	807	807	831	884	972	-
		<p><b>Note:</b></p> <p>Doors with wide angle hinges may not be planned alongside units or panels if the protrusion to the front of the adjoining article is greater than 3 cm (hinge side). Doors with wide angle hinges protrude over the carcass side.</p>									
R/L ▲	▲	U 50 85 55 05	699	707	760	807	807	831	884	972	-
		U 60 85 55 05	732	742	791	855	855	888	947	1042	-
		<p><b>Note:</b></p> <p>Doors with wide angle hinges may not be planned alongside units or panels if the protrusion to the front of the adjoining article is greater than 3 cm (hinge side). Doors with wide angle hinges protrude over the carcass side.</p>									

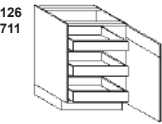


**Base unit for recyclable materials sack**  
1 door 84.1 cm  
1 liner holder for securing bin liners  
Cover with practical storage recess  
Dimensions: W x H x D 320 x 466 x 542 mm  
1 x 42 litres  
Metal parts silver-coloured, plastic parts light grey



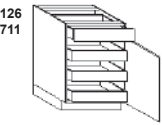
**Base unit**  
1 door 84.1 cm with wide angle hinges  
with 3 internal drawers

**Planning advice:**  
Take account of opening angle



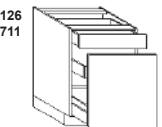
**Base unit**  
1 panel 12.6 cm attached to 1 door 71.1 cm  
with wide angle hinges  
with 3 internal drawers

**Planning advice:**  
Take account of opening angle

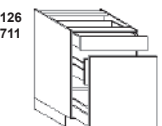


**Base unit**  
1 drawer 12.6 cm  
1 door 71.1 cm with wide angle hinges  
with 3 internal drawers

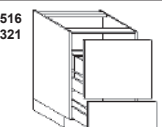
**Planning advice:**  
Take account of opening angle



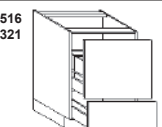
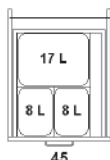
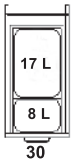
**Base unit**  
1 drawer 12.6 cm  
1 pull-out with front panel 71.1 cm  
with 1 internal drawer



**Base unit**  
1 drawer 12.6 cm  
1 pull-out with front panel 71.1 cm  
with 1 internal pull-out



**Base unit**  
1 pull-out 51.6 cm  
with waste bins  
1 pull-out 32.1 cm



**Base unit**  
1 pull-out 51.6 cm  
with 4 waste bins  
1 pull-out 32.1 cm





# Base units 84.5 cm high

Carcase depth 55.5 cm (standard)

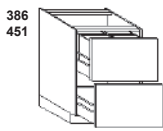
# LINE E

## Price groups

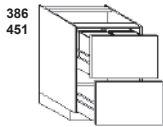
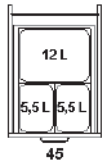
- = Models also available in 34/45.5/61 cm carcass depth (Order no.: ... replace ... 55 ... with 34/45/61)
- = Models also available in 45.5/61 cm carcass depth (order no.: replace ... 55 ... with 45/61)
- ▲ = Types also available with 61 cm carcass depth (order no.: ... replace ... 55 ... with 61)

Order no.  
W H D

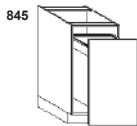
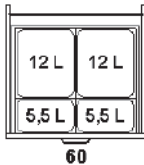
Hinge side:	Carcass depth	Price groups									
		1	2	3	4	5	6	7	8	9	
▲	55.5	U 30 85 55 051	699	707	760	807	807	831	884	972	-
		U 45 85 55 051	699	707	760	807	807	831	884	972	-
▲	55.5	U 50 85 55 051	699	707	760	807	807	831	884	972	-
		U 60 85 55 051	732	742	791	855	855	888	947	1042	-
▲	55.5	U 45 85 55 94	543	557	576	645	684	707	747	822	-
		⚡ Not available with TIP-ON									
▲	55.5	U 60 85 55 95	570	584	603	672	711	734	774	851	-
		⚡ Not available with TIP-ON									
▲	55.5	U 60 85 55 961	570	584	603	672	711	734	774	851	-
		⚡ Not available with TIP-ON Blumotion									
▲	55.5	U 15 85 55 088	348	355	381	448	470	488	523	575	-
		⚡ Not available for: MIAMI, VIVA									
		⚡ Available frame fronts are supplied with smooth fronts. Most handles arranged vertically!									
▲	55.5	U 20 85 55 088	348	355	381	448	470	488	523	575	-
		⚡ Not available for: BERGEN, LUGANO									
		⚡ Note: pull-out as for unit in 15 cm width (U 15 85 55 09) Most handles arranged vertically!									



**Base unit**  
1 pull-out 38.6 cm  
with waste bins  
1 pull-out 45.1 cm



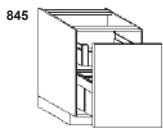
**Base unit**  
1 pull-out 38.6 cm  
with 4 waste bins  
1 pull-out 45.1 cm



**Base unit**  
1 pull-out with front panel 84.1 cm  
with frame and 1 waste bin  
for dropping in (Hailo)  
waste system: 1x55 litres



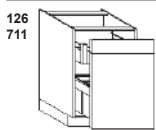
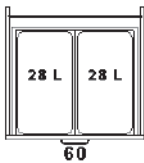
⚡ Not available with TIP-ON



**Base unit**  
1 pull-out with front panel 84.1 cm  
with frame and 2 waste bins  
for dropping in (Hailo)  
1 internal pull-out



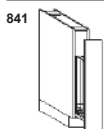
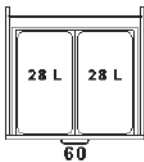
⚡ Not available with TIP-ON



**Base unit**  
1 panel 12.6 cm attached to 1 door 71.1 cm  
with frame and 2 waste bins  
for dropping in  
1 internal pull-out



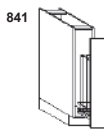
⚡ Not available with TIP-ON Blumotion



**Base unit**  
1 pull-out 84.1 cm  
and 1 basket (chrome-plated)



⚡ Not available for: MIAMI, VIVA  
⚡ Available frame fronts are supplied with smooth fronts. Most handles arranged vertically!



**Base unit**  
1 pull-out 84.1 cm  
and 1 basket (chrome-plated)



⚡ Not available for: BERGEN, LUGANO  
⚡ Note: pull-out as for unit in 15 cm width (U 15 85 55 09) Most handles arranged vertically!

# Base units 84.5 cm high

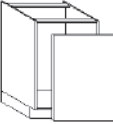
Carcase depth 55.5 cm (standard)

- = Models also available in 34/45.5/61 cm carcass depth (Order no.: ... replace ... 55 ... with 34/45/61)
- = Models also available in 45.5/61 cm carcass depth (order no.: replace ... 55 ... with 45/61)
- ▲ = Types also available with 61 cm carcass depth (order no. ... replace ... 55 ... with 61)

# LINE E

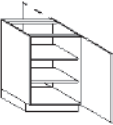

Order no.  
W H D

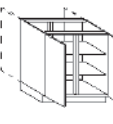

Hinge side:	Carcass depth	Price groups								
		1	2	3	4	5	6	7	8	9
■	55.5	229	237	262	314	334	349	379	417	-
■	61.0	229	237	262	320	334	353	384	422	-
■	61.0	229	237	262	320	334	353	384	422	-
■	61.0	229	237	262	320	353	376	416	458	-
■	61.0	263	275	295	360	406	431	472	519	-

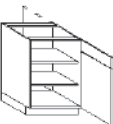

 <p><b>Base unit</b> 1 front 84.1 cm, separate</p>	34,0	<b>U</b>	<b>30 85 55 79</b>		■	229	237	262	314	334	349	379	417	-
	45,5	<b>U</b>	<b>40 85 55 79</b>		■	229	237	262	320	334	353	384	422	-
	55,5	<b>U</b>	<b>45 85 55 79</b>		■	229	237	262	320	334	353	384	422	-
	61,0	<b>U</b>	<b>50 85 55 79</b>		■	229	237	262	320	353	376	416	458	-
	61,0	<b>U</b>	<b>60 85 55 79</b>		■	263	275	295	360	406	431	472	519	-

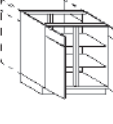

## Base units as pass-throughs 84.5 cm high



Carcass depth 55.5 cm (standard)

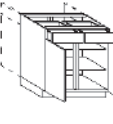

 <p><b>Base unit as pass-through</b> 1 door 84.1 cm 2 adjustable shelves</p>		<b>UDU</b>	<b>45 85 55 70</b>	R/L ▲	215	227	254	321	337	360	393	432	-
		<b>UDU</b>	<b>50 85 55 70</b>	R/L ▲	215	227	254	321	360	385	430	473	-
		<b>UDU</b>	<b>60 85 55 70</b>	R/L ▲	255	269	292	366	420	447	496	546	-
		 <b>Note:</b> Door hinged front left = door hinged rear right. Always from the perspective of standing in front of the unit. Please order additional doors for the rear side.											


 <p><b>Base unit as pass-through</b> 2 doors 84.1 cm 2 adjustable shelves</p>		<b>UDU</b>	<b>80 85 55 70</b>	▲	288	300	334	481	580	629	708	779	-
		<b>UDU</b>	<b>90 85 55 70</b>	▲	288	300	334	481	580	629	709	780	-
		<b>UDU</b>	<b>100 85 55 70</b>	▲	302	316	355	509	580	629	710	781	-
		<b>UDU</b>	<b>120 85 55 70</b>	▲	349	371	425	603	689	744	837	921	-
	 <b>Note:</b> Door hinged front left = door hinged rear right. Always from the perspective of standing in front of the unit. Please order additional doors for the rear side.												


 <p><b>Base unit as pass-through</b> 1 panel 12.6 cm attached to 1 door 71.1 cm connected 2 adjustable shelves</p>		<b>UDU</b>	<b>45 85 55 60</b>	R/L ▲	215	227	254	321	337	360	393	432	-
		<b>UDU</b>	<b>50 85 55 60</b>	R/L ▲	215	227	254	321	360	385	430	473	-
		<b>UDU</b>	<b>60 85 55 60</b>	R/L ▲	255	269	292	366	420	447	496	546	-
		 <b>Note:</b> Door hinged front left = door hinged rear right. Always from the perspective of standing in front of the unit. Please order additional doors for the rear side.											


 <p><b>Base unit as pass-through</b> 2 panels 12.6 cm attached to 2 doors 71.1 cm 2 adjustable shelves</p>		<b>UDU</b>	<b>80 85 55 60</b>	▲	288	300	334	481	580	629	708	779	-
		<b>UDU</b>	<b>90 85 55 60</b>	▲	288	300	334	481	580	629	709	780	-
		<b>UDU</b>	<b>100 85 55 60</b>	▲	302	316	355	509	580	629	710	781	-
		<b>UDU</b>	<b>120 85 55 60</b>	▲	349	371	425	603	689	744	837	921	-
	 <b>Note:</b> Door hinged front left = door hinged rear right. Always from the perspective of standing in front of the unit. Please order additional doors for the rear side.												

 <p><b>Base unit as pass-through</b> 1 drawer 12.6 cm 1 door 71.1 cm 2 adjustable shelves</p>		<b>UDU</b>	<b>45 85 55 10</b>	R/L ▲	271	281	310	384	423	442	482	530	-
		<b>UDU</b>	<b>50 85 55 10</b>	R/L ▲	271	281	310	384	422	446	488	537	-
		<b>UDU</b>	<b>60 85 55 10</b>	R/L ▲	308	322	360	437	477	507	559	615	-
		 <b>Note:</b> Door hinged front left = door hinged rear right. Always from the perspective of standing in front of the unit. Please order additional doors for the rear side.											

 <p><b>Base unit as pass-through</b> 2 drawers 12.6 cm 2 doors 71.1 cm 2 adjustable shelves</p>		<b>UDU</b>	<b>80 85 55 18</b>	▲	417	432	456	624	692	738	819	901	-
		<b>UDU</b>	<b>90 85 55 18</b>	▲	417	432	462	626	692	738	820	902	-
		<b>UDU</b>	<b>100 85 55 18</b>	▲	434	444	481	651	692	738	824	906	-
		<b>UDU</b>	<b>120 85 55 18</b>	▲	482	507	551	747	812	865	964	1060	-
	 <b>Note:</b> Door hinged front left = door hinged rear right. Always from the perspective of standing in front of the unit. Please order additional doors for the rear side.												

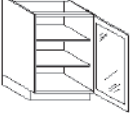

 <p><b>Base unit door</b> With fitting drill hole Without fitting, Height: 841 mm</p>		<b>E-TUO</b>	<b>40 85</b>	R/L	72	105	123	161	215	259	282	310	-
		<b>E-TUO</b>	<b>45 85</b>	R/L	74	114	137	175	234	288	316	348	-
		<b>E-TUO</b>	<b>50 85</b>	R/L	85	125	148	186	258	310	341	375	-
		<b>E-TUO</b>	<b>60 85</b>	R/L	86	148	171	212	298	373	410	451	-

 <p><b>Base unit door</b> With fitting drill hole Without fitting, Height: 711 mm</p>		<b>E-TUO</b>	<b>20 72</b>	R/L	52	54	73	105	129	170	186	205	-
		<b>E-TUO</b>	<b>25 72</b>	R/L	58	68	85	117	147	184	204	224	-
		<b>E-TUO</b>	<b>30 72</b>	R/L	60	77	98	129	161	207	227	250	-
		<b>E-TUO</b>	<b>40 72</b>	R/L	70	101	120	157	209	251	275	303	-
		<b>E-TUO</b>	<b>45 72</b>	R/L	72	111	133	169	228	281	306	337	-
		<b>E-TUO</b>	<b>50 72</b>	R/L	83	122	144	180	250	301	331	364	-
		<b>E-TUO</b>	<b>60 72</b>	R/L	84	144	166	207	288	363	398	438	-

 <p><b>Fixed panel</b> Height: 126 mm</p>		<b>E-BF</b>	<b>40 13</b>		49	50	52	76	105	112	121	133	-
		<b>E-BF</b>	<b>45 13</b>		50	51	53	78	109	114	123	135	-
		<b>E-BF</b>	<b>50 13</b>		51	52	54	83	113	120	131	144	-
		<b>E-BF</b>	<b>60 13</b>		53	54	59	87	118	133	144	158	-

## Base units with glass door 84.5 cm high neutral

Carcase depth 55.5 cm (standard)

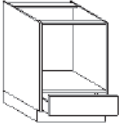



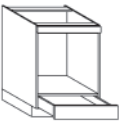

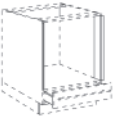
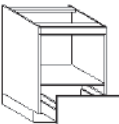

				Glass groups						
				Order no. W H D						
				Hinge side:	Carcase depth	G1	G2	G2S	G5S	G6
841		<b>Base unit with glass front</b> -neutral- 1 glass door 84.1 cm 2 adjustable glass shelves	34,0	R/L	■	-	-	543	622	927
			45,5	R/L	■	-	-	563	638	947
			55,5	R/L	■	-	-	615	695	999
				 <b>Important!</b> For carcase depth 34 cm with wall mounting.						
<b>G1</b>			<b>G2</b>			<b>G2S</b>				
G1 AKTIVglass frame 991 Matt glass 992 Translucent black glass			G2 Design front 925 Frame White Agate/Matt glass 935 Premium W. Frame/Matt Glass 940 Macaron Col. Frame/Matt Glass 95 Light grey frame/matt glass 96 Silver Col. Frame/Matt Glass 960 Snow White Frame/Matt Glass 97 Black frame/black glass			G2S aluminium, framed glass door 988 aluminium black, Linea glass 994 Aluminium frame/clear glass 995 aluminium frame/black glass				
<b>G5</b>			<b>G5S</b>			<b>G6</b>				
G5 aluminium, door with mullion			G5S Alum.frame/clear gl./cross bar			G6 NEW SALON 986 aluminium black, black glass 987 aluminium black, clear glass 989 aluminium matt, bronze-coloured black glass 990 aluminium matt, bronze-coloured clear glass				

## Additional equipment

				Decor groups									
				Order no. W H D									
				IDF-U	M10	M20	M30	M40	M50	M60	M70	M80	M90
<b>Surcharge for bas cabinets with glass fronts inside and exterior in the same design</b> available in decor groups: S/B/H/MP/F/Z				IDF-U	-	-	-	-	802	-	802	802	-
<b>M 10</b>		<b>M 20</b>		<b>M 30</b>		<b>M 40</b>		<b>M 50</b>					
K M10 laminate								B M50 Velvet lacquer S M50 microstructure lacquer					
<b>M 60</b>		<b>M 70</b>		<b>M 80</b>		<b>M 90</b>							
		F M70 veneer / oak / walnut Z M70 Veneer / Bavaria		H M80 high gloss-Lacquer MP M80 laqué mat Premium									

## Oven housings 84.5 cm high

Carcase depth 55.5 cm (standard)

				Price groups										
				Order no. W H D										
				Hinge side:	Carcase depth	1	2	3	4	5	6	7	8	9
240		<b>Oven housing</b> 1 drawer 24 cm	NZ	▲	▲	259	260	268	282	282	294	311	342	-
				 <b>Note:</b> When planning with induction hotplates please take into account the specifications of the manufacturer for the thickness of the worktop. When fronts are laminate-coated, do not forget heat shields. (Model HP...)										
240		<b>Oven housing</b> 1 spacious drawer with panel 24 cm high	NZ	▲	▲	283	287	299	308	311	317	335	369	-
				 <b>Note:</b> When planning with induction hotplates please take into account the specifications of the manufacturer for the thickness of the worktop. When fronts are laminate-coated, do not forget heat shields. (Model HP...) For use only as a slot-in solution or in conjunction with 1 base support panel. Minimum plinth height: 10 cm Only available with laminate drawer.										
191		<b>Oven housing</b> 1 fixed panel 1 open aperture 1 drawer 19.1 cm	NZ	▲	▲	302	305	317	335	351	377	419	461	-
				 <b>Note:</b> When fronts are laminate-coated, do not forget heat shields. (Model HP...)										
		<b>Heat shields</b> to protect fronts adjacent to oven silver-coloured price per pair				17,10								
321		<b>Base unit for microwave</b> 1 fixed panel 1 open aperture (aperture height 36.3 to 48.4 cm) 1 pull-out 32.1 cm	NZ	▲	▲	340	341	352	376	376	385	404	444	-
				▲	▲	375	376	385	409	409	418	421	463	-
				 <b>Important!</b> Please indicate appliance type and manufacturer when ordering. With 90 cm width, with full-width panel.										

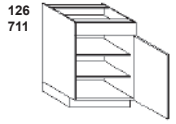
# Hob base units 84.5 cm high

Carcase depth 55.5 cm (standard)

Please follow the fitting instructions from the appliance manufacturers.  
 ▲ = Types also available with 61 cm carcass depth (order no. ... replace ... 55 ... with 61)

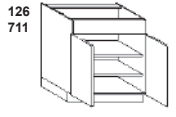
Order no.  
 W H D

Hinge side:	Carcass depth	Price groups								
		1	2	3	4	5	6	7	8	9
R/L ▲	▲	228	236	264	331	369	390	431	474	-
		22,80								
▲	▲	248	264	298	423	511	554	624	686	-
		22,80								
▲	▲	263	275	312	447	511	554	625	688	-
▲	▲	292	301	347	495	525	566	638	702	-
		22,80								
R/L ▲	▲	348	359	389	456	491	513	559	615	-
▲	▲	403	414	443	583	638	676	745	820	-
▲	▲	403	414	443	583	638	676	745	820	-
▲	▲	413	423	456	596	652	691	762	838	-
▲	▲	421	432	465	608	665	705	778	856	-
Width 80, 100 Not available for: GENT, INTARSIA, OSLO 15, TESSIN 15, TIM 15, VILLAGE 15-B, VILLAGE 15-S Width 90, 120 Not available for: INTARSIA										
R/L ▲	▲	429	439	472	537	570	595	640	704	-
▲	▲	508	516	549	686	740	780	848	933	-
▲	▲	513	524	554	691	746	785	853	938	-
▲	▲	541	550	583	721	776	816	886	975	-
▲	▲	572	584	619	758	813	853	926	1019	-
Width 80, 100 Not available for: GENT, INTARSIA, OSLO 15, TESSIN 15, TIM 15, VILLAGE 15-B, VILLAGE 15-S Width 90, 120 Not available for: INTARSIA										
R/L ▲	▲	429	439	472	537	570	595	640	704	-
Important! Cutlery organisers are not available for this article.										
▲	▲	508	516	549	686	740	780	848	933	-
▲	▲	513	524	554	691	746	785	853	938	-
▲	▲	541	550	583	721	776	816	886	975	-
▲	▲	572	584	619	758	813	853	926	1019	-
Width 80, 100 Not available for: GENT, INTARSIA, OSLO 15, TESSIN 15, TIM 15, VILLAGE 15-B, VILLAGE 15-S Width 90, 120 Not available for: INTARSIA										
Important! Cutlery organisers are not available for this article.										



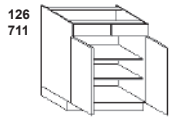
**Hob base unit**  
 1 panel 12.6 cm  
 1 cable protective shelf  
 1 door 71.1 cm  
 2 adjustable shelves

**Cutout for control panel**



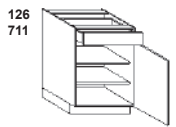
**Hob base unit**  
 1 full-width panel 12.6 cm  
 1 cable protective shelf  
 2 doors 71.1 cm  
 Left door with buffer strip  
 Without centre panel  
 2 adjustable shelves

**Cutout for control panel**

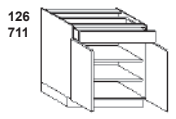


**Hob base unit**  
 2 panels 12.6 cm  
 1 cable protective shelf  
 2 doors 71.1 cm  
 Left door with buffer strip  
 Without centre panel  
 2 adjustable shelves

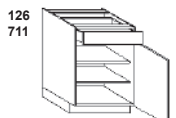
**Cutout for control panel**



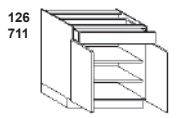
**Hob base unit**  
 1 drawer 12.6 cm  
 with low frame  
 1 door 71.1 cm  
 2 adjustable shelves



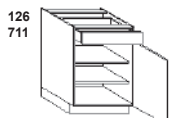
**Hob base unit**  
 1 drawer 12.6 cm  
 with low frame  
 with full-width panel  
 2 doors 71.1 cm  
 Left door with buffer strip  
 Without centre panel



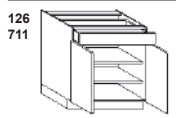
**Hob base unit for induction hobs**  
 1 drawer 12.6 cm  
 with low frame  
 1 heat shield  
 1 door 71.1 cm  
 2 adjustable shelves



**Hob base unit for induction hobs**  
 1 drawer 12.6 cm  
 with low frame  
 with full-width panel  
 1 heat shield  
 2 doors 71.1 cm  
 2 adjustable shelves  
 Left door with buffer strip  
 Without centre panel



**Hob base unit for induction hobs**  
 1 drawer 12.6 cm with carcass depth 45.5 cm  
 with low frame  
 1 heat shield  
 1 door 71.1 cm  
 2 adjustable shelves



**Hob base unit for induction hobs**  
 1 drawer 12.6 cm with carcass depth 45.5 cm  
 with low frame  
 with full-width panel  
 1 heat shield  
 2 doors 71.1 cm  
 2 adjustable shelves  
 Left door with buffer strip  
 Without centre panel

# Hob base units 84.5 cm high

Carcase depth 55.5 cm (standard)

Please follow the fitting instructions from the appliance manufacturers.  
 ▲ = Types also available with 61 cm carcass depth (order no. ... replace ... 55 ... with 61)

Order no.  
W H D

Hinge side:	Carcass depth	Price groups										
		1	2	3	4	5	6	7	8	9		
126 256 451		<b>Hob base unit</b> 1 panel 12.6 cm 1 cable protective shelf 1 pull-out 25.6 cm 1 pull-out 45.1 cm	UK 60 85 55 82	▲ 466	479	532	615	615	642	701	771	-
		UK 70 85 55 82	▲ 748	766	855	883	898	950	1055	1161	-	
		UK 80 85 55 82	▲ 748	766	855	883	898	950	1055	1161	-	
		UK 90 85 55 82	▲ 748	766	855	883	898	950	1055	1161	-	
		UK 100 85 55 82	▲ 776	799	893	923	936	992	1102	1212	-	
		UK 120 85 55 82	▲ 802	829	926	961	975	1037	1149	1264	-	
	<b>Cutout for control panel</b>	UK-AA	22,80									
126 451 256		<b>Hob base unit</b> 1 panel 12.6 cm 1 cable protective shelf 1 pull-out 45.1 cm 1 pull-out 25.6 cm	UK 60 85 55 820	▲ 466	479	532	615	615	642	701	771	-
		UK 70 85 55 820	▲ 748	766	855	883	898	950	1055	1161	-	
		UK 80 85 55 820	▲ 748	766	855	883	898	950	1055	1161	-	
		UK 90 85 55 820	▲ 748	766	855	883	898	950	1055	1161	-	
		UK 100 85 55 820	▲ 776	799	893	923	936	992	1102	1212	-	
		UK 120 85 55 820	▲ 802	829	926	961	975	1037	1149	1264	-	
	<b>Cutout for control panel</b>	UK-AA	22,80									
126 321 386		<b>Hob base unit</b> 1 drawer 12.6 cm with low frame 1 cable protective shelf 1 pull-out 32.1 cm 1 pull-out 38.6 cm	UKI 60 85 55 12	▲ 594	605	652	722	722	755	810	891	-
		UKI 70 85 55 12	▲ 887	902	991	1077	1094	1142	1249	1374	-	
		UKI 80 85 55 12	▲ 887	902	991	1077	1094	1142	1249	1374	-	
		UKI 90 85 55 12	▲ 887	902	991	1077	1094	1142	1249	1374	-	
		UKI 100 85 55 12	▲ 915	935	1025	1115	1131	1187	1293	1422	-	
		UKI 120 85 55 12	▲ 941	964	1060	1149	1171	1231	1343	1477	-	
126 321 386		<b>Hob base unit</b> 1 drawer 12.6 cm with carcass depth 45.5 cm with low frame 1 cable protective shelf 1 pull-out 32.1 cm 1 pull-out 38.6 cm	UKI 60 85 55 13	▲ 594	605	652	722	722	755	810	891	-
		UKI 70 85 55 13	▲ 887	902	991	1077	1094	1142	1249	1374	-	
		UKI 80 85 55 13	▲ 887	902	991	1077	1094	1142	1249	1374	-	
		UKI 90 85 55 13	▲ 887	902	991	1077	1094	1142	1249	1374	-	
		UKI 100 85 55 13	▲ 915	935	1025	1115	1131	1187	1293	1422	-	
		UKI 120 85 55 13	▲ 941	964	1060	1149	1171	1231	1343	1477	-	
126 256 451		<b>Hob base unit for induction hobs</b> 1 drawer 12.6 cm with low frame 1 heat shield 1 pull-out 25.6 cm 1 pull-out 45.1 cm	UKI 60 85 55 4	▲ 675	687	734	801	801	834	889	978	-
		UKI 80 85 55 4	▲ 993	1008	1095	1179	1196	1246	1349	1484	-	
		UKI 90 85 55 4	▲ 999	1013	1101	1185	1202	1252	1356	1492	-	
		UKI 100 85 55 4	▲ 1043	1062	1154	1239	1256	1313	1419	1561	-	
		UKI 120 85 55 4	▲ 1095	1116	1212	1301	1319	1381	1489	1638	-	
		126 256 451		<b>Hob base unit for induction hobs</b> 1 drawer 12.6 cm with carcass depth 45.5 cm with low frame 1 heat shield 1 pull-out 25.6 cm 1 pull-out 45.1 cm	UKI 60 85 55 41	▲ 675	687	734	801	801	834	889
UKI 80 85 55 41	▲ 993			1008	1095	1179	1196	1246	1349	1484	-	
UKI 90 85 55 41	▲ 999			1013	1101	1185	1202	1252	1356	1492	-	
UKI 100 85 55 41	▲ 1043			1062	1154	1239	1256	1313	1419	1561	-	
UKI 120 85 55 41	▲ 1095			1116	1212	1301	1319	1381	1489	1638	-	
126 386 321				<b>Hob base unit</b> 1 drawer 12.6 cm with low frame 1 cable protective shelf 1 pull-out 38.6 cm 1 pull-out 32.1 cm	UKI 60 85 55 120	▲ 594	605	652	722	722	755	810
		UKI 70 85 55 120	▲ 887	902	991	1077	1094	1142	1249	1374	-	
		UKI 80 85 55 120	▲ 887	902	991	1077	1094	1142	1249	1374	-	
		UKI 90 85 55 120	▲ 887	902	991	1077	1094	1142	1249	1374	-	
		UKI 100 85 55 120	▲ 915	935	1025	1115	1131	1187	1293	1422	-	
		UKI 120 85 55 120	▲ 941	964	1060	1149	1171	1231	1343	1477	-	
126 386 321		<b>Hob base unit</b> 1 drawer 12.6 cm with carcass depth 45.5 cm with low frame 1 cable protective shelf 1 pull-out 38.6 cm 1 pull-out 32.1 cm	UKI 60 85 55 122	▲ 594	605	652	722	722	755	810	891	-
		UKI 70 85 55 122	▲ 887	902	991	1077	1094	1142	1249	1374	-	
		UKI 80 85 55 122	▲ 887	902	991	1077	1094	1142	1249	1374	-	
		UKI 90 85 55 122	▲ 887	902	991	1077	1094	1142	1249	1374	-	
		UKI 100 85 55 122	▲ 915	935	1025	1115	1131	1187	1293	1422	-	
		UKI 120 85 55 122	▲ 941	964	1060	1149	1171	1231	1343	1477	-	
126 386 321		<b>Hob base unit for induction hobs</b> 1 drawer 12.6 cm with low frame 1 heat shield 1 pull-out 38.6 cm 1 pull-out 32.1 cm	UKI 60 85 55 40	▲ 675	687	734	801	801	834	889	978	-
		UKI 80 85 55 40	▲ 993	1008	1095	1179	1196	1246	1349	1484	-	
		UKI 90 85 55 40	▲ 999	1013	1101	1185	1202	1252	1356	1492	-	
		UKI 100 85 55 40	▲ 1043	1062	1154	1239	1256	1313	1419	1561	-	
		UKI 120 85 55 40	▲ 1095	1116	1212	1301	1319	1381	1489	1638	-	



## Hob base units 84.5 cm high

Carcase depth 55.5 cm (standard)

Please follow the fitting instructions from the appliance manufacturers.

▲ = Types also available with 61 cm carcass depth (order no. ... replace ... 55 ... with 61)

Order no.

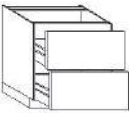

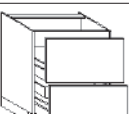

W H D

Hinge side:	Carcass depth	Price groups									
		1	2	3	4	5	6	7	8	9	
▲	55.5	UKI 60 85 55 42	675	687	734	801	801	834	889	978	-
		UKI 80 85 55 42	993	1008	1095	1179	1196	1246	1349	1484	-
		UKI 90 85 55 42	999	1013	1101	1185	1202	1252	1356	1492	-
		UKI 100 85 55 42	1043	1062	1154	1239	1256	1313	1419	1561	-
		UKI 120 85 55 42	1095	1116	1212	1301	1319	1381	1489	1638	-
▲	61	UKI 60 85 55 22	702	711	760	828	828	859	917	1009	-
		UKI 70 85 55 22	994	1008	1095	1180	1195	1250	1350	1485	-
		UKI 80 85 55 22	994	1008	1095	1180	1195	1250	1350	1485	-
		UKI 90 85 55 22	994	1008	1095	1180	1195	1250	1350	1485	-
		UKI 100 85 55 22	1025	1046	1137	1227	1243	1301	1408	1549	-
UKI 120 85 55 22	1060	1084	1185	1279	1292	1360	1471	1618	-		
▲	61	UKI 60 85 55 23	702	711	760	828	828	859	917	1009	-
		UKI 70 85 55 23	994	1008	1095	1180	1195	1250	1350	1485	-
		UKI 80 85 55 23	994	1008	1095	1180	1195	1250	1350	1485	-
		UKI 90 85 55 23	994	1008	1095	1180	1195	1250	1350	1485	-
		UKI 100 85 55 23	1025	1046	1137	1227	1243	1301	1408	1549	-
UKI 120 85 55 23	1060	1084	1185	1279	1292	1360	1471	1618	-		
▲	61	UKI 60 85 55 5	784	793	841	907	907	938	995	1095	-
		UKI 80 85 55 5	1098	1113	1200	1283	1295	1350	1454	1599	-
		UKI 90 85 55 5	1106	1119	1205	1289	1303	1358	1460	1606	-
		UKI 100 85 55 5	1154	1173	1267	1352	1367	1427	1534	1687	-
		UKI 120 85 55 5	1212	1236	1338	1429	1439	1507	1618	1780	-
▲	61	UKI 60 85 55 51	784	793	841	907	907	938	995	1095	-
		UKI 80 85 55 51	1098	1113	1200	1283	1295	1350	1454	1599	-
		UKI 90 85 55 51	1106	1119	1205	1289	1303	1358	1460	1606	-
		UKI 100 85 55 51	1154	1173	1267	1352	1367	1427	1534	1687	-
		UKI 120 85 55 51	1212	1236	1338	1429	1439	1507	1618	1780	-
▲	61	UK 60 85 55 81	512	524	572	643	643	675	731	804	-
		UK 70 85 55 81	808	826	909	1001	1014	1064	1171	1288	-
		UK 80 85 55 81	808	826	909	1001	1014	1064	1171	1288	-
		UK 90 85 55 81	808	826	909	1001	1014	1064	1171	1288	-
		UK 100 85 55 81	835	855	947	1039	1055	1111	1218	1340	-
		UK 120 85 55 81	863	886	982	1075	1095	1154	1267	1394	-
▲	61	UDK 70 85 55 028	889	906	995	1083	1098	1151	1253	1378	-
		UDK 80 85 55 028	889	906	995	1083	1098	1151	1253	1378	-
		UDK 90 85 55 028	889	906	995	1083	1098	1151	1253	1378	-
		UDK 100 85 55 028	909	926	1017	1109	1126	1180	1287	1416	-
		UDK 120 85 55 028	926	947	1041	1134	1151	1211	1318	1450	-
▲	61	UDK 70 85 55 088	889	906	995	1083	1098	1151	1253	1378	-
		UDK 80 85 55 088	889	906	995	1083	1098	1151	1253	1378	-
		UDK 90 85 55 088	889	906	995	1083	1098	1151	1253	1378	-
		UDK 100 85 55 088	909	926	1017	1109	1126	1180	1287	1416	-
		UDK 120 85 55 088	926	947	1041	1134	1151	1211	1318	1450	-

## Hob base units 84.5 cm high for hob extractors

Carcass depth 55.5 cm (standard)

Please follow the fitting instructions from the appliance manufacturers. ▲ = Types also available with 61 cm carcass depth (order no. ... replace ... 55 ... with 61)

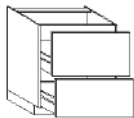
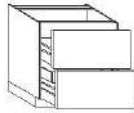
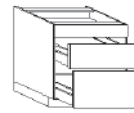
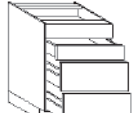
386 451		<b>Hob base unit for hob extractor</b> 1 fixed inside panel 1 pull-out 38.6 cm 1 pull-out 45.1 cm	UDK 80 85 55 02	▲	770	787	876	965	978	1035	1133	1246	-
			UDK 90 85 55 02	▲	770	787	876	965	978	1035	1133	1246	-
			UDK 100 85 55 02	▲	790	807	898	990	1005	1060	1167	1284	-
			UDK 120 85 55 02	▲	807	828	921	1014	1035	1092	1199	1319	-
			 <b>Note:</b> The pull-outs are adapted to the respective hob extractor type. We will not assume any liability for damage caused by moisture.										
451 386		<b>Hob base unit for hob extractor</b> 1 fixed inside panel 1 pull-out 45.1 cm 1 internal drawer 1 pull-out 38.6 cm	UDK 80 85 55 082	▲	906	920	1008	1096	1110	1161	1265	1392	-
			UDK 90 85 55 082	▲	909	923	1011	1100	1113	1166	1268	1395	-
			UDK 100 85 55 082	▲	934	953	1045	1131	1147	1203	1309	1440	-
			UDK 120 85 55 082	▲	987	1005	1103	1193	1207	1268	1374	1511	-
			 <b>Note:</b> The pull-outs are adapted to the respective hob extractor type. We will not assume any liability for damage caused by moisture.										

# Hob base units 84.5 cm high for hob extractors

Carcase depth 55.5 cm (standard)

Please follow the fitting instructions from the appliance manufacturers.

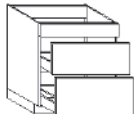
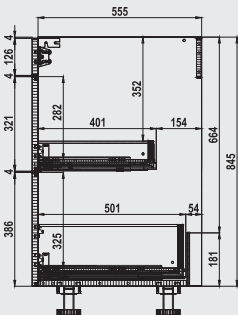
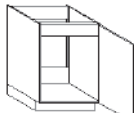
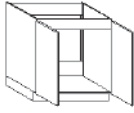
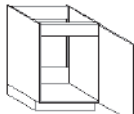
▲ = Types also available with 61 cm carcass depth (order no. ... replace ... 55 ... with 61)

Order no.	W	H	D	Hinge side:	Carcass depth	Price groups								
						1	2	3	4	5	6	7	8	9
451 386 	<b>UDK 80 85 55 08</b>			▲		770	787	876	965	978	1035	1133	1246	-
	<b>UDK 90 85 55 08</b>			▲		770	787	876	965	978	1035	1133	1246	-
	<b>UDK 100 85 55 08</b>			▲		790	807	898	990	1005	1060	1167	1284	-
	<b>UDK 120 85 55 08</b>			▲		807	828	921	1014	1035	1092	1199	1319	-
<b>Note:</b>														
The pull-outs are adapted to the respective hob extractor type.														
We will not assume any liability for damage caused by moisture.														
386 451 	<b>UDK 80 85 55 022</b>			▲		906	920	1008	1096	1110	1161	1265	1392	-
	<b>UDK 90 85 55 022</b>			▲		909	923	1011	1100	1113	1166	1268	1395	-
	<b>UDK 100 85 55 022</b>			▲		934	953	1045	1131	1147	1203	1309	1440	-
	<b>UDK 120 85 55 022</b>			▲		987	1005	1103	1193	1207	1268	1374	1511	-
<b>Note:</b>														
The pull-outs are adapted to the respective hob extractor type.														
We will not assume any liability for damage caused by moisture.														
126 256 451 	<b>UDK 80 85 55 82</b>			▲		748	766	855	883	898	950	1055	1161	-
	<b>UDK 90 85 55 82</b>			▲		748	766	855	883	898	950	1055	1161	-
	<b>UDK 100 85 55 82</b>			▲		776	799	893	923	936	992	1102	1212	-
	<b>UDK 120 85 55 82</b>			▲		802	829	926	961	975	1037	1149	1264	-
<b>Note:</b>														
The pull-outs are adapted to the respective hob extractor type.														
We will not assume any liability for damage caused by moisture.														
126 256 321 	<b>UDK 80 85 55 81</b>			▲		903	922	1010	1039	1054	1107	1208	1329	-
	<b>UDK 90 85 55 81</b>			▲		903	922	1010	1039	1054	1107	1208	1329	-
	<b>UDK 100 85 55 81</b>			▲		931	954	1047	1078	1092	1147	1256	1382	-
	<b>UDK 120 85 55 81</b>			▲		957	985	1081	1116	1130	1190	1304	1434	-
<b>Note:</b>														
The pull-outs are adapted to the respective hob extractor type.														
We will not assume any liability for damage caused by moisture.														

# Sink carcasses 84.5 cm high

Carcass depth 55.5 cm (standard)

□ = Models also available in 45.5/61 cm carcass depth (order no.: replace ... 55 ... with 45/61) ▲ = Types also available with 61 cm carcass depth (order no. ... replace ... 55 ... with 61)

126 321 386 	<b>US 60 85 55 881</b>			▲		536	548	594	665	681	697	755	831	-
	<b>US 70 85 55 881</b>			▲		885	905	994	1017	1037	1083	1187	1306	-
	<b>US 80 85 55 881</b>			▲		885	905	994	1017	1037	1083	1187	1306	-
	<b>US 90 85 55 881</b>			▲		885	905	994	1017	1037	1083	1187	1306	-
	<b>US 100 85 55 881</b>			▲		913	933	1026	1055	1073	1128	1233	1356	-
	<b>US 120 85 55 881</b>			▲		936	966	1062	1094	1113	1171	1284	1412	-
														
841 	<b>US 40 85 55 701</b>			R/L	▲	210	223	237	300	335	356	390	429	-
	<b>US 45 85 55 701</b>			R/L	▲	212	224	240	301	337	359	391	430	-
	<b>US 50 85 55 701</b>			R/L	▲	214	225	242	302	339	369	400	440	-
	<b>US 60 85 55 701</b>			R/L	▲	244	260	278	347	385	410	449	494	-
841 	<b>US 80 85 55 701</b>				▲	278	297	324	461	534	573	641	705	-
	<b>US 90 85 55 701</b>				▲	282	299	328	463	536	576	644	708	-
	<b>US 100 85 55 701</b>				▲	300	311	345	493	538	578	648	713	-
	<b>US 120 85 55 701</b>				▲	341	367	409	569	620	666	752	827	-
841 	<b>US 30 85 55 702</b>			R/L	□	187	196	217	276	312	333	371	408	-
	<b>US 40 85 55 702</b>			R/L	□	187	196	217	276	312	333	371	408	-
	<b>US 45 85 55 702</b>			R/L	□	187	196	217	276	312	333	371	408	-
	<b>US 50 85 55 702</b>			R/L	□	187	196	217	276	312	339	375	413	-
	<b>US 60 85 55 702</b>			R/L	□	217	230	253	322	359	379	422	464	-



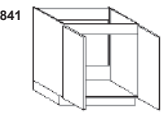
# Sink carcasses 84.5 cm high

Carcase depth 55.5 cm (standard)

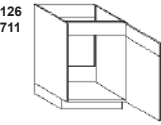
□ = Models also available in 45.5/61 cm carcass depth (order no.: replace ... 55 ... with 45/61)  
 ▲ = Types also available with 61 cm carcass depth (order no. ... replace ... 55 ... with 61)

Order no.  
W H D

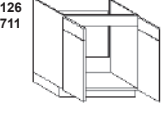
Hinge side:	Carcass depth	Price groups									
		1	2	3	4	5	6	7	8	9	
□	55.5	US 80 85 55 702	242	259	284	424	495	537	603	663	-
		US 90 85 55 702	242	259	284	424	495	537	605	666	-
		US 100 85 55 702	258	268	303	449	495	537	606	667	-
		US 120 85 55 702	298	319	359	519	573	621	704	774	-
R/L ▲	61	US 40 85 55 601	210	223	237	300	335	356	390	429	-
		US 45 85 55 601	212	224	240	301	337	359	391	430	-
		US 50 85 55 601	214	225	242	302	339	369	400	440	-
		US 60 85 55 601	244	260	278	347	385	410	449	494	-
▲	61	US 80 85 55 601	278	297	324	461	534	573	641	705	-
		US 90 85 55 601	282	299	328	463	536	576	644	708	-
		US 100 85 55 601	300	311	345	493	538	578	648	713	-
		US 120 85 55 601	341	367	409	569	620	666	752	827	-
R/L □	55.5	US 30 85 55 602	187	196	217	276	312	333	371	408	-
		US 40 85 55 602	187	196	217	276	312	333	371	408	-
		US 45 85 55 602	187	196	217	276	312	333	371	408	-
		US 50 85 55 602	187	196	217	276	312	339	375	413	-
R/L □	61	US 60 85 55 602	217	230	253	322	359	379	422	464	-
		US 80 85 55 602	242	259	284	424	495	537	603	663	-
		US 90 85 55 602	242	259	284	424	495	537	605	666	-
		US 100 85 55 602	258	268	303	449	495	537	606	667	-
□	55.5	US 120 85 55 602	298	319	359	519	573	621	704	774	-
		US 80 85 55 13	300	311	342	489	546	583	650	715	-
		US 90 85 55 13	300	311	342	489	546	583	652	717	-
		US 100 85 55 13	310	324	359	509	546	583	655	721	-
R/L ▲	61	US 120 85 55 13	353	377	420	579	619	666	750	825	-
		US 70 85 55 026	909	924	1011	1098	1113	1167	1269	1396	-
		US 80 85 55 026	909	924	1011	1098	1113	1167	1269	1396	-
		US 90 85 55 026	909	924	1011	1098	1113	1167	1269	1396	-
▲	61	US 100 85 55 026	926	942	1036	1125	1137	1196	1300	1430	-
		US 120 85 55 026	940	968	1059	1151	1166	1223	1332	1465	-



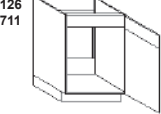
**Sink carcass**  
 2 doors 84.1 cm  
 1 inside panel  
 without aluminium protective shelf  
 Left door with buffer strip  
 Without centre panel



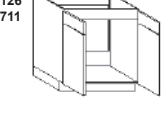
**Sink carcass**  
 1 panel 12.6 cm attached to  
 1 door 71.1 cm connected  
 1 inside panel  
 1 aluminium protective shelf



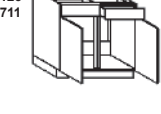
**Sink carcass**  
 2 panels 12.6 cm attached to  
 2 doors 71.1 cm  
 1 inside panel  
 Left door with buffer strip  
 Without centre panel  
 1 aluminium protective shelf



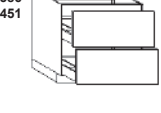
**Sink carcass**  
 1 panel 12.6 cm attached to  
 1 door 71.1 cm connected  
 1 inside panel  
 without aluminium protective shelf



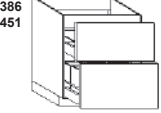
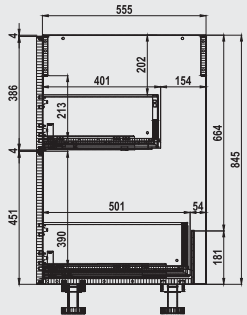
**Sink carcass**  
 2 panels 12.6 cm attached to  
 2 doors 71.1 cm  
 1 inside panel  
 Left door with buffer strip  
 Without centre panel  
 without aluminium protective shelf



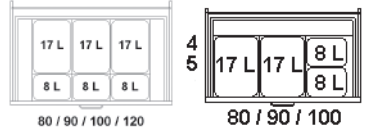
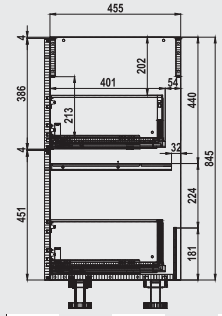
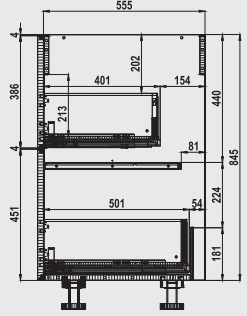
**Sink carcass**  
 1 panel 12.6 cm  
 1 drawer 12.6 cm right or left  
 2 doors 71.1 cm  
 With centre panel



**Sink carcass**  
 1 pull-out 38.6 cm, 45.5 cm deep  
 with full-width panel with wooden rear panel  
 reduced in height 1 moulded part for drain set  
 1 pull-out 45.1 cm  
 with full-width panel



**Sink carcass**  
 1 pull-out 38.6 cm, 45.5 cm deep  
 with full-width panel with wooden rear panel  
 reduced in height 1 moulded part for drain set  
 1 pull-out 45.1 cm  
 with full-width panel 1 waste system in bottom  
 pull-out



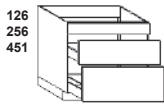
# Sink carcasses 84.5 cm high

Carcase depth 55.5 cm (standard)

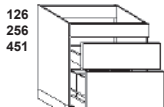
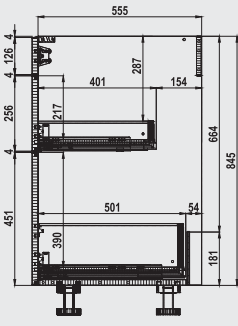
□ = Models also available in 45.5/61 cm carcass depth (order no.: replace ... 55 ... with 45/61)  
 ▲ = Types also available with 61 cm carcass depth (order no. ... replace ... 55 ... with 61)

Order no.  
 W H D

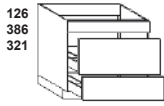
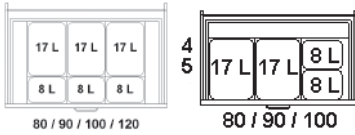
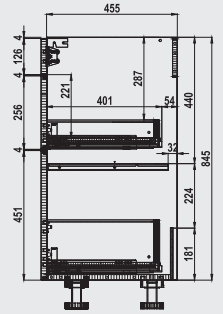
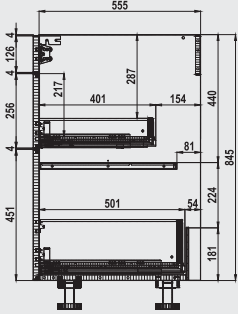
Hinge side: Carcass depth	Price groups									
	1	2	3	4	5	6	7	8	9	
▲	US 70 85 55 826	885	905	994	1017	1037	1083	1187	1306	-
	US 80 85 55 826	885	905	994	1017	1037	1083	1187	1306	-
	US 90 85 55 826	885	905	994	1017	1037	1083	1187	1306	-
	US 100 85 55 826	913	933	1026	1055	1073	1128	1233	1356	-
	US 120 85 55 826	936	966	1062	1094	1113	1171	1284	1412	-
□	US 80 85 55 827	1255	1275	1366	1381	1396	1445	1552	1707	-
	US 90 85 55 827	1255	1275	1366	1381	1396	1445	1552	1707	-
	US 100 85 55 827	1291	1314	1407	1426	1442	1498	1605	1766	-
	US 120 85 55 827	1331	1358	1456	1477	1497	1554	1639	1803	-
▲	US 70 85 55 828	885	905	994	1017	1037	1083	1187	1306	-
	US 80 85 55 828	885	905	994	1017	1037	1083	1187	1306	-
	US 90 85 55 828	885	905	994	1017	1037	1083	1187	1306	-
	US 100 85 55 828	913	933	1026	1055	1073	1128	1233	1356	-
	US 120 85 55 828	936	966	1062	1094	1113	1171	1284	1412	-
□	US 30 85 55 88	616	621	652	721	738	763	800	880	-
	US 40 85 55 88	616	621	652	721	738	763	800	880	-
	US 45 85 55 88	616	621	652	721	738	763	800	880	-



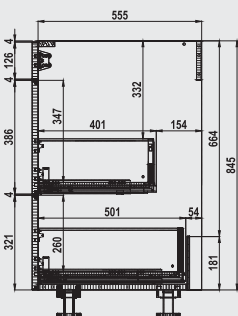
**Sink carcass**  
 1 full-width panel 12.6 cm  
 1 drawer 25.6 cm, 45.5 cm deep  
 with full-width panel  
 1 moulded part for drain set  
 1 pull-out 45.1 cm  
 with full-width panel



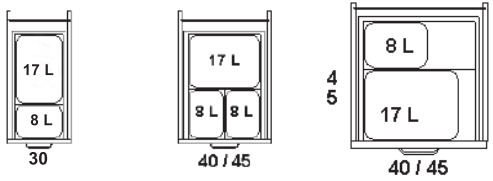
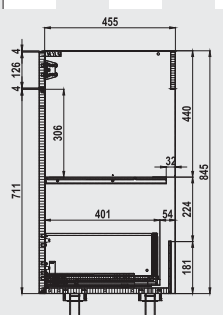
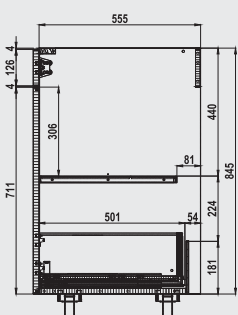
**Sink carcass**  
 1 full-width panel 12.6 cm  
 1 drawer 25.6 cm, 45.5 cm deep  
 with full-width panel  
 1 moulded part for drain set  
 1 pull-out 45.1 cm  
 with full-width panel  
 1 waste system in bottom pull-out



**Sink carcass**  
 1 full-width panel 12.6 cm  
 1 pull-out 38.6 cm, 45.5 cm deep  
 with full-width panel with wooden rear panel  
 reduced in height 1 moulded part for drain set  
 1 pull-out 32.1 cm  
 with full-width panel



**Sink carcass**  
 1 panel 12.6 cm  
 1 pull-out 71.1 cm  
 with waste bins



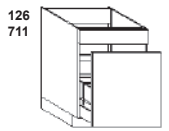
# Sink carcasses 84.5 cm high

Carcass depth 55.5 cm (standard)

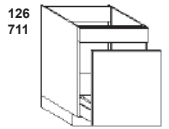
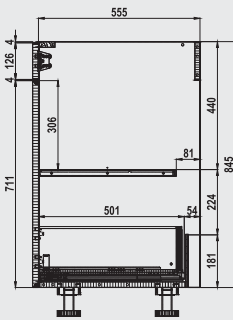
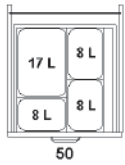
□ = Models also available in 45.5/61 cm carcass depth (order no.: replace ... 55 ... with 45/61)  
 ▲ = Types also available with 61 cm carcass depth (order no. ... replace ... 55 ... with 61)

Order no.  
W H D

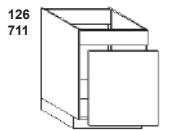
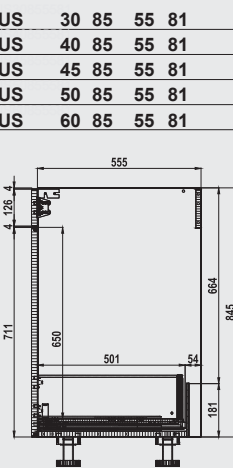
Hinge side:	Carcass depth	Price groups								
		1	2	3	4	5	6	7	8	9
□	650	656	688	754	772	796	831	914	-	
	681	694	734	796	812	836	875	963	-	
▲	311	322	339	398	437	455	492	541	-	
	311	322	339	398	437	455	492	541	-	
	311	322	339	398	437	455	492	541	-	
	311	322	339	398	437	460	495	545	-	
	340	353	378	443	482	501	548	603	-	
▲	212	224	240	301	337	359	391	430	-	
	214	225	242	302	339	369	400	440	-	
	244	260	278	347	385	410	449	494	-	
▲	212	224	240	301	337	359	391	430	-	
	214	225	242	302	339	369	400	440	-	
	244	260	278	347	385	410	449	494	-	
▲	578	587	606	667	702	724	758	834	-	
	584	595	615	673	709	738	770	847	-	
	630	646	665	732	771	795	836	920	-	



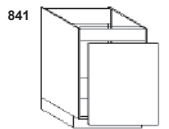
**Sink carcass**  
 1 panel 12.6 cm  
 1 pull-out 71.1 cm  
 with waste bins



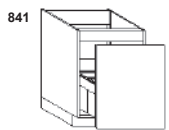
**Sink carcass**  
 1 panel 12.6 cm  
 1 pull-out 71.1 cm  
 without waste bin



**Sink carcass for waste bin**  
 1 panel 12.6 cm  
 1 front 71.1 cm, separate  
 1 aluminium protective shelf



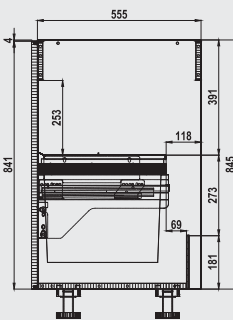
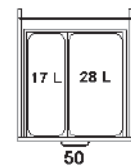
**Sink carcass for waste bin**  
 1 inside panel  
 1 front 84.1 cm, separate  
 1 aluminium protective shelf



**Sink carcass**  
 1 pull-out with front panel 84.1 cm  
 with frame and waste bin  
 for dropping in (Hailo)  
 1 inside panel



Not available with TIP-ON



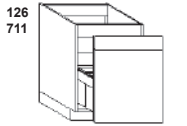
# Sink carcasses 84.5 cm high

Carcase depth 55.5 cm (standard)

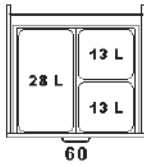
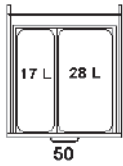
□ = Models also available in 45.5/61 cm carcass depth (order no.: replace ... 55 ... with 45/61)  
 ▲ = Types also available with 61 cm carcass depth (order no. ... replace ... 55 ... with 61)

Order no.  
 W H D

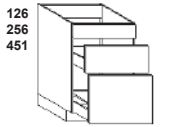
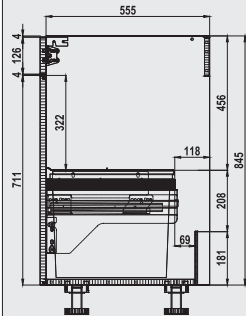
Hinge side: Carcass depth	Price groups								
	1	2	3	4	5	6	7	8	9
▲	578	587	606	667	702	724	758	834	-
▲	584	595	615	673	709	738	770	847	-
▲	630	646	665	732	771	795	836	920	-



**Sink carcass**  
 1 panel 12.6 cm  
 1 pull-out 71.1 cm  
 with frame and waste bin  
 for dropping in (Hailo)



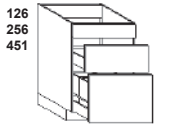
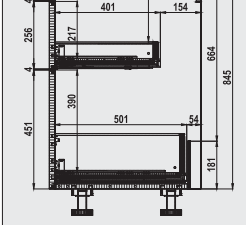
US **45 85 55 951**  
 US **50 85 55 951**  
 US **60 85 55 951**  
 Not available with TIP-ON



**Sink carcass**  
 1 panel 12.6 cm  
 1 drawer 25.6 cm, 45.5 cm deep  
 1 moulded part for drain set  
 1 pull-out 45.1 cm



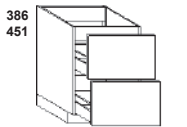
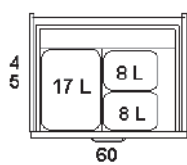
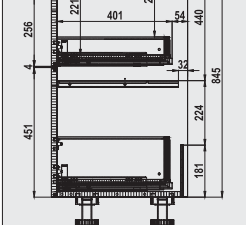
US **60 85 55 820**



**Sink carcass**  
 1 panel 12.6 cm  
 1 drawer 25.6 cm, 45.5 cm deep  
 1 moulded part for drain set  
 1 pull-out 45.1 cm  
 1 waste system in bottom pull-out



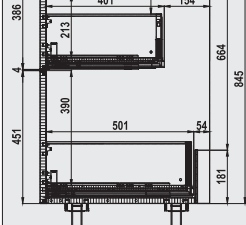
US **60 85 55 821**



**Sink carcass**  
 1 pull-out 38.6 cm, 45.5 cm deep  
 with wooden rear panel  
 reduced in height 1 inside panel  
 1 moulded part for drain set  
 1 pull-out 45.1 cm



US **60 85 55 020**



# Sink carcasses 84.5 cm high

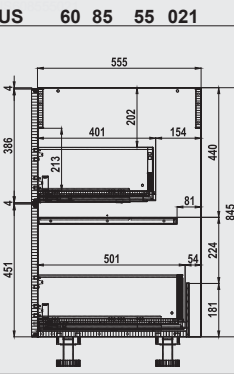
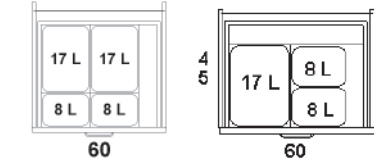
Carcass depth 55.5 cm (standard)

□ = Models also available in 45.5/61 cm carcass depth (order no.: replace ... 55 ... with 45/61)  
 ▲ = Types also available with 61 cm carcass depth (order no. ... replace ... 55 ... with 61)

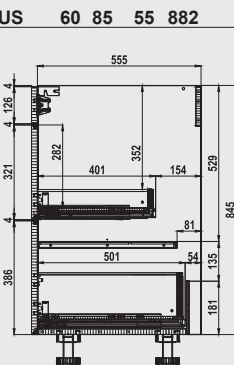
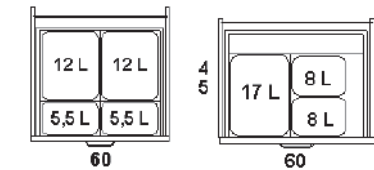
Order no.  
 W H D

Hinge side:	Carcass depth	Price groups								
		1	2	3	4	5	6	7	8	9
□	55.5	758	765	813	881	896	909	969	1066	-
□	55.5	789	802	849	917	930	947	1005	1106	-
□	55.5	1255	1275	1366	1381	1396	1445	1552	1707	-
□	55.5	1255	1275	1366	1381	1396	1445	1552	1707	-
□	55.5	1291	1314	1407	1426	1442	1498	1605	1766	-
▲	55.5	1331	1358	1456	1477	1497	1554	1639	1803	-
	291									
▲	55.5	552	565	589	656	695	712	760	836	-

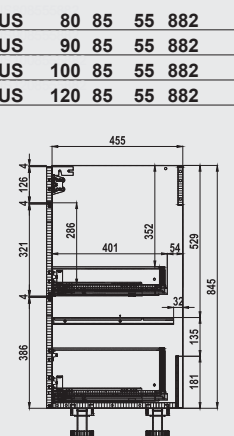
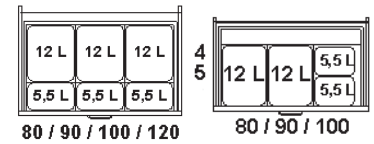
**Sink carcass**  
 1 pull-out 38.6 cm, 45.5 cm deep with wooden rear panel reduced in height 1 inside panel  
 1 moulded part for drain set  
 1 pull-out 45.1 cm  
 1 waste system in bottom pull-out



**Sink carcass**  
 1 full-width panel 12.6 cm  
 1 drawer 32.1 cm, 45.5 cm deep  
 1 moulded part for drain set  
 1 pull-out 38.6 cm  
 1 waste system in bottom pull-out

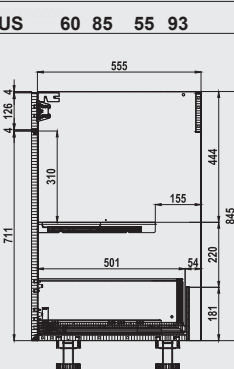
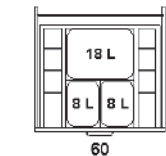


**Sink carcass**  
 1 full-width panel 12.6 cm  
 1 drawer 32.1 cm, 45.5 cm deep with full-width panel  
 1 moulded part for drain set  
 1 pull-out 38.6 cm with full-width panel  
 1 waste system in bottom pull-out



**Electronic opening assistance for pull-outs Hailo Libero 3.0**  
 For base units from 300 mm to 1200 mm width

**Sink carcass**  
 1 fixed panel 12.6 cm  
 1 pull-out with front panel 71.1 cm with Hailo Separato-K waste separation system with extendable lid



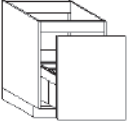
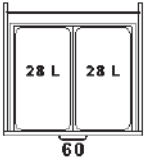
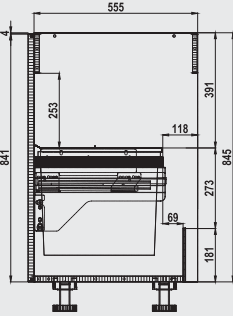
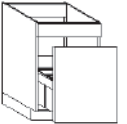
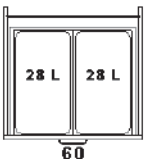
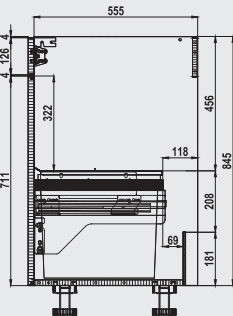
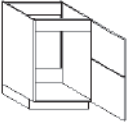
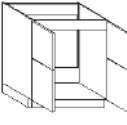
# Sink carcasses 84.5 cm high

Carcase depth 55.5 cm (standard)

□ = Models also available in 45.5/61 cm carcass depth (order no.: replace ... 55 ... with 45/61)  
 ▲ = Types also available with 61 cm carcass depth (order no. ... replace ... 55 ... with 61)

Order no.  
W H D

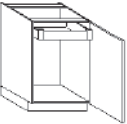
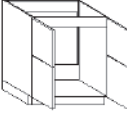
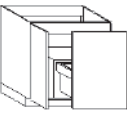
Hinge side: Carcass depth	Price groups								
	1	2	3	4	5	6	7	8	9

841	 <b>Sink carcass</b> 1 pull-out with front panel 84.1 cm with frame and waste bin for dropping in (Hailo)	 28 L 28 L 60	 555, 391, 841, 253, 118, 273, 845, 181, 69	US 60 85 55 96	▲	630	646	665	732	771	795	836	920	-
				Not available with TIP-ON PTO										
	<b>Extra charge Sink carcass with full back panel</b>			SA50SVR		34								
126 711	 <b>Sink carcass</b> 1 fixed panel 12.6 cm 1 pull-out 71.1 cm with frame and 2 waste bins for dropping in (Hailo)	 28 L 28 L 60	 555, 459, 711, 322, 118, 208, 845, 181, 69	US 60 85 55 961	▲	630	646	665	732	771	795	836	920	-
				Not available with TIP-ON PTO										
386 451	 <b>Sink carcass</b> 1 door consisting of 1 panel 38.6 cm attached to 1 panel 45.1 cm 1 inside panel 1 aluminium protective shelf			US 40 85 55 721	R/L ▲	210	223	237	300	335	356	390	429	-
				US 45 85 55 721	R/L ▲	212	224	240	301	337	359	391	430	-
				US 50 85 55 721	R/L ▲	214	225	242	302	339	369	400	440	-
				US 60 85 55 721	R/L ▲	244	260	278	347	385	410	449	494	-
386 386	 <b>Sink carcass</b> 2 doors consisting of 2 panels 38.6 cm attached to 2 panels 45.1 cm  1 inside panel 1 aluminium protective shelf Left door with buffer strip Without centre panel			US 80 85 55 721	▲	323	342	370	506	579	619	687	756	-
				US 90 85 55 721	▲	329	345	374	508	581	621	690	759	-
				US 100 85 55 721	▲	346	356	390	538	583	623	693	762	-
				US 120 85 55 721	▲	387	414	454	615	666	712	799	879	-

## Base units 84.5 cm high for water purifying, boiling and chilling systems

Carcass depth 55.5 cm (standard)

□ = Models also available in 45.5/61 cm carcass depth (order no.: replace ... 55 ... with 45/61) ▲ = Types also available with 61 cm carcass depth (order no. ... replace ... 55 ... with 61)

841	 <b>Base unit for purifying, boiling and chilling water</b> 1 door 84.1 cm 1 internal drawer with 1 Ambia-Line frame set for storing cartridges 1 aluminium protective shelf			UWS 45 85 55 70	R/L ▲	443	454	470	531	566	588	620	682	-
				UWS 60 85 55 70	R/L ▲	506	523	540	608	647	672	712	783	-
67.5 cm clear installed height and 50.5 cm clear installed height for water purifying, boiling and chilling systems Please follow the fitting instructions from the appliance manufacturers														
386 386	 <b>Sink carcass ideal for incorporating into water purifier, boiling and chilling systems, like Quooker</b> 2 doors consisting of 2 panels 38.6 cm attached to 2 panels 45.1 cm  1 inside panel 1 aluminium protective shelf Left door with buffer strip Without centre panel			US 90 85 55 721	▲	329	345	374	508	581	621	690	759	-
				Optional accessories HW UTB Utensils box, e.g. for storing towels, cleaning cloths, etc. (for screwing on), anthracite HAS T 15 15 Hailo AS Tandem waste bin										
841	 <b>Sink carcass for water treatment system</b> 1 door 84.1 cm (29.6 cm wide) 1 pull-out 84.1 cm (front 59.6 cm wide) 1 inside panel with frame and waste bin for hanging Hailo Cargo Flex 1x 28 l, 2x 13 l			NEW US 90 85 55 97	R/L ▲	796	813	839	979	1050	1092	1158	1218	-

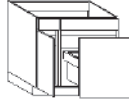


# Base units 84.5 cm high for water purifying, boiling and chilling systems

Carcase depth 55.5 cm (standard)

□ = Models also available in 45.5/61 cm carcass depth (order no.: replace ... 55 ... with 45/61)  
 ▲ = Types also available with 61 cm carcass depth (order no. ... replace ... 55 ... with 61)

Order no.  
W H D

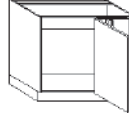

Hinge side: Carcass depth	Price groups								
	1	2	3	4	5	6	7	8	9
R/L ▲	796	813	839	979	1050	1092	1158	1218	-

	<b>Sink carcass for water treatment system</b> 1 panel 12.6 cm 1 door 71.1 cm (29.6 cm wide) 1 panel 12.6 cm 1 pull-out 71.1 cm (front 59.6 cm wide) with frame and waste bin for hanging Hailo Cargo Flex 1x 28 l, 2x 13 l	<b>NEW</b>	<b>US 90 85 55 971</b>										
			<b>Hailo AS Tandem waste bin</b> Number of containers: 2 Volume: 2 x 15 l Color: dark gray suitable for units with hinged doors from a width of 30 cm	<b>HAST 15 15</b>									
	<b>Utensils box</b> Utensils box, e.g. for storing towels, cleaning cloths, etc. (for screwing on), anthracite		<b>HW-UB</b>										

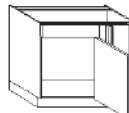

## Corner base units Sink carcasses 84.5 cm high

Carcass depth 55.5 cm (standard)

□ = Models also available in 45.5/61 cm carcass depth (order no.: replace ... 55 ... with 45/61) ▲ = Types also available with 61 cm carcass depth (order no. ... replace ... 55 ... with 61)

	<b>Corner sink base unit, variable</b> Blind section left or right 1 inside panel 1 door 84.1 cm Carcase width 100 cm with loose corner filler	<b>PTO</b>	 <i>Items in ALU TEC RP model are only available with a fixed corner angle min. 6 x 6 cm. Handle N700/775: with fixed corner angle.</i>										
	<i>Ill. right</i> Door 40 cm Door 45 cm Door 50 cm Door 60 cm		<b>USE 105 85 55 7</b> <b>USE 110 85 55 7</b> <b>USE 115 85 55 7</b> <b>USE 125 85 55 7</b>	R/L □									

	<b>PLV</b>													

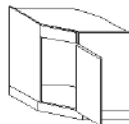

	<b>Corner sink base unit, variable</b> Blind section left or right 1 panel 12.6 cm 1 door 71.1 cm Carcase width 100 cm with loose corner filler	<b>PTO</b>	 <i>Items in ALU TEC RP model are only available with a fixed corner angle min. 6 x 6 cm. Handle N700/775: with fixed corner angle.</i>										
	<i>Ill. right</i> Door 40 cm Door 45 cm Door 50 cm Door 60 cm		<b>USE 105 85 55 8</b> <b>USE 110 85 55 8</b> <b>USE 115 85 55 8</b> <b>USE 125 85 55 8</b>	R/L □									

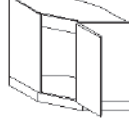

	<b>PLV</b>													

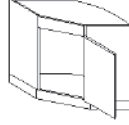

## Diagonal corner base unit Sink carcasses 84.5 cm high

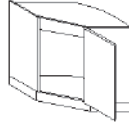

Carcass depth 55.5 cm (standard)

□ = Models also available in 45.5/61 cm carcass depth (order no.: replace ... 55 ... with 45/61)

	<b>Diagonal sink base unit</b> 90 x 90 cm, inside depth 72.5 cm 1 panel 12.6 cm 1 door 40 cm wide, 71.1 cm high		<b>USD 90 85 80</b>	R/L										
	 <i>Not available for: ALU TEC RP</i>													


	<b>Diagonal sink base unit</b> 90 x 90 cm, inside depth 72.5 cm 1 door 40 cm wide, 84.1 cm high with 1 inside panel		<b>USD 90 85 70</b>	R/L										
	 <i>Not available for: ALU TEC RP</i>													


	<b>Diagonal sink base unit</b> 105 x 105 cm, inside depth 72.5 cm 1 panel 12.6 cm 1 door 60 cm wide, 71.1 cm high		<b>USD 105 85 80</b>	R/L										
	 <i>Not available for: ALU TEC RP</i>													


	<b>Diagonal sink base unit</b> 105 x 105 cm, inside depth 72.5 cm 1 door 60 cm wide, 84.1 cm high with 1 inside panel		<b>USD 105 85 70</b>	R/L										
	 <i>Not available for: ALU TEC RP</i>													




## Fronts for electrical appliances for appliance height 82 cm

		Price groups								
Hinge side:	Carcase depth	1	2	3	4	5	6	7	8	9

Please specify the dishwasher item number when ordering.

Order no.  
W H D

1	2	3	4	5	6	7	8	9
---	---	---	---	---	---	---	---	---

126		<b>Base for raised dishwasher</b> for carcase height 84.5 cm 1 fixed panel 12.6 cm 1 appliance shelf with plinth feet		UGS 45 85 55	▲	128	129	134	161	192	207	218	240	-
				UGS 60 85 55	▲	135	136	140	167	199	213	226	249	-
				Not available for: ALU TEC RP										
				Note: from a plinth height of 5 cm										
581		<b>Base unit door, 58.1 cm</b> as front panel for integrated dishwashers 44.6 cm wide with 45 cm 59.6 cm wide with 60 cm		Important! Only plan large-volume dishwashers with a plinth height of at least 15 cm.										
				UT 45 59		70	74	89	112	149	163	181	199	-
				UT 60 59		82	85	99	134	178	188	216	238	-
711		<b>Base unit door, 71.1 cm</b> as front panel for fully integrated dishwashers 82 cm high 44.6 cm wide with 45 cm 59.6 cm wide with 60 cm		Not available for: MIAMI, VIVA										
				UT 45 72 82 1		96	100	108	120	186	207	244	268	-
				UT 60 72 82 1		108	112	122	134	218	236	281	309	-
126 581		<b>Base unit door, 71.1 cm</b> as front panel for fully integrated dishwashers 82 cm high drawer panel 12.6 cm attached to door 58.1 cm 44.6 cm wide with 45 cm Surcharge in connection with the grip rails N700 and N775 incl. connecting plate and additional grip rails 59.6 cm wide with 60 cm Surcharge in connection with the grip rails N700 and N775 incl. connecting plate and additional grip rails		Note: Only possible in combination with UGS 45/60 85 55.										
				Not available for: MIAMI, VIVA										
				UTV 45 72 82		96	100	108	120	186	207	244	268	-
				Extra charge for MP-GSN...		145	145	145	145	145	145	145	145	145
				UTV 60 72 82		108	112	122	134	218	236	281	309	-
				Extra charge for MP-GSN...		148	148	148	148	148	148	148	148	-

## Fronts for electrical appliances for appliance height 82 - 87 cm

		Price groups								
Hinge side:	Carcase depth	1	2	3	4	5	6	7	8	9

Please specify the dishwasher item number when ordering.

Order no.  
W H D

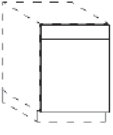
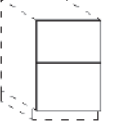
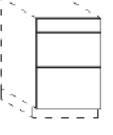
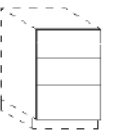
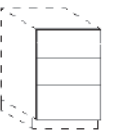
1	2	3	4	5	6	7	8	9
---	---	---	---	---	---	---	---	---

841		<b>Base unit door, 84.1 cm</b> As front panel for fully integrated dishwashers 82-87 cm high and pull-out fridges and freezers 44.6 cm wide with 45 cm 59.6 cm wide with 60 cm		possible from a plinth height of 10 cm! from a plinth height of 5 cm, only with appliances with special door technology (connected door technology, varioHinge, etc.) The base unit door including intermediate shelf and removable compensation panel (in carcase decor) will be delivered for on-site adjustment.											
				UT 45 85 1		214	218	231	240	328	350	391	430	-	
				UT 60 85 1		214	218	231	240	328	350	391	430	-	
126 711		<b>Base unit door, 84.1 cm</b> As front panel for fully integrated dishwashers 82-87 cm high and pull-out fridges and freezers Drawer panel 12.6 cm connected with door 71.1 cm 44.6 cm wide with 45 cm Surcharge in connection with the grip rails N700 and N775 incl. connecting plate and additional grip rails 59.6 cm wide with 60 cm Surcharge in connection with the grip rails N700 and N775 incl. connecting plate and additional grip rails		possible from a plinth height of 10 cm! from a plinth height of 5 cm, only with appliances with special door technology (connected door technology, varioHinge, etc.) The base unit door including intermediate shelf and removable compensation panel (in carcase decor) will be delivered for on-site adjustment.											
				UTV 45 85		214	218	231	240	328	350	391	430	-	
				Extra charge for MP-GSN...		145	145	145	145	145	145	145	145	145	-
				UTV 60 85		214	218	231	240	328	350	391	430	-	
				Extra charge for MP-GSN...		148	148	148	148	148	148	148	148	-	
841		<b>Base unit door, 84.1 cm</b> for integrated built-under fridges with door and fully integrated washing machines 44.6 cm wide with 45 cm 59.6 cm wide with 60 cm		The base unit door including intermediate shelf and removable compensation panel (in carcase decor) will be delivered for on-site adjustment.											
				UT 45 85 11	R/L	214	218	231	240	328	350	391	430	-	
				UT 60 85 11	R/L	214	218	231	240	328	350	391	430	-	

# Fronts for electrical appliances for appliance height 82 - 87 cm

Please specify the dishwasher item number when ordering.

Order no.  
W H D

		Price groups											
		Hinge side:	Carcase depth	1	2	3	4	5	6	7	8	9	
<p>126 711</p>  <p><b>Base unit door, 84.1 cm</b> for integrated built-under fridges with door and fully integrated washing machines Drawer panel 12.6 cm connected with door 71.1 cm</p> <p>44.6 cm wide with 45 cm <i>Surcharge in connection with the grip rails N700 and N775 incl. connecting plate and additional grip rails</i></p> <p>59.6 cm wide with 60 cm <i>Surcharge in connection with the grip rails N700 and N775 incl. connecting plate and additional grip rails</i></p>	<p>⚡ <i>The base unit door including intermediate shelf and removable compensation panel (in carcase decor) will be delivered for on-site adjustment.</i></p>												
		<b>UTV 45 85 1</b>	R/L	214	218	231	240	328	350	391	430	-	
		<b>Extra charge for MP-GSN...</b>		145	145	145	145	145	145	145	145	145	
		<b>UTV 60 85 1</b>	R/L	214	218	231	240	328	350	391	430	-	
<p>386 451</p>  <p><b>Base unit door, 84.1 cm</b> As front panel for <b>fully integrated</b> dishwashers 82-87 cm high split into 2 connected panels with 38.6 cm and 45.1 cm each Front incl. intermediate shelf and removable compensation panel in carcase decor (panel for adjusting on site) 44.6 cm wide with 45 cm <i>Surcharge in connection with the grip rails N700 and N775 incl. connecting plate and additional grip rails</i></p> <p>59.6 cm wide with 60 cm <i>Surcharge in connection with the grip rails N700 and N775 incl. connecting plate and additional grip rails</i></p>	<p>⚡ <b>possible from a plinth height of 10 cm!</b> <b>from a plinth height of 5 cm, only with appliances with special door technology (connected door technology, varioHinge, etc.)</b> <i>The base unit door including intermediate shelf and removable compensation panel (in carcase decor) will be delivered for on-site adjustment.</i></p>												
		<b>UT 45 85 02</b>		247	254	268	278	389	414	466	513	-	
		<b>Extra charge for MP-GSN...</b>		145	145	145	145	145	145	145	145	145	
		<b>UT 60 85 02</b>		247	254	268	278	389	414	466	513	-	
<p>126 321 386</p>  <p><b>Base unit door, 84.1 cm</b> As front panel for <b>fully integrated</b> dishwashers 82-87 cm high split into 2 drawer panel 12.6 cm connected pull-out panels 32.1 cm and 38.6 cm Front incl. intermediate shelf and removable compensation panel in carcase decor (panel for adjusting on site)</p> <p>44.6 cm wide with 45 cm <i>Surcharge in connection with the grip rails N700 and N775 incl. connecting plate and additional grip rails</i></p> <p>59.6 cm wide with 60 cm <i>Surcharge in connection with the grip rails N700 and N775 incl. connecting plate and additional grip rails</i></p>	<p>⚡ <b>possible from a plinth height of 10 cm!</b> <b>from a plinth height of 5 cm, only with appliances with special door technology (connected door technology, varioHinge, etc.)</b> <i>The base unit door including intermediate shelf and removable compensation panel (in carcase decor) will be delivered for on-site adjustment.</i></p>												
		<b>UT 45 85 12</b>		247	254	268	278	389	414	466	513	-	
		<b>Extra charge for MP-GSN...</b>		261	261	261	261	261	261	261	261	261	
		<b>UT 60 85 12</b>		247	254	268	278	389	414	466	513	-	
<p>256 256 321</p>  <p><b>Base unit door, 84.1 cm</b> As front panel for <b>fully integrated</b> dishwashers 82-87 cm high split into 2 pull-out panels 25.6 cm and 1 panel 32.1 cm Front incl. intermediate shelf and removable compensation panel in carcase decor (panel for adjusting on site) 44.6 cm wide with 45 cm <i>Surcharge in connection with the grip rails N700 and N775 incl. connecting plate and additional grip rails</i></p> <p>59.6 cm wide with 60 cm <i>Surcharge in connection with the grip rails N700 and N775 incl. connecting plate and additional grip rails</i></p>	<p>⚡ <b>possible from a plinth height of 10 cm!</b> <b>from a plinth height of 5 cm, only with appliances with special door technology (connected door technology, varioHinge, etc.)</b> <i>The base unit door including intermediate shelf and removable compensation panel (in carcase decor) will be delivered for on-site adjustment.</i></p>												
		<b>UT 45 85 03</b>		247	254	268	278	389	414	466	513	-	
		<b>Extra charge for MP-GSN...</b>		261	261	261	261	261	261	261	261	261	
		<b>UT 60 85 03</b>		247	254	268	278	389	414	466	513	-	
<p>256 256 321</p>  <p><b>Base unit door, 84.1 cm</b> As front panel for <b>fully integrated</b> dishwashers 82-87 cm high split into 2 pull-out panels 25.6 cm and 1 panel 32.1 cm Front incl. intermediate shelf and removable compensation panel in carcase decor (panel for adjusting on site) 44.6 cm wide with 45 cm <i>Surcharge in connection with the grip rails N700 and N775 incl. connecting plate and additional grip rails</i></p> <p>59.6 cm wide with 60 cm <i>Surcharge in connection with the grip rails N700 and N775 incl. connecting plate and additional grip rails</i></p>	<p>⚡ <b>possible from a plinth height of 10 cm!</b> <b>from a plinth height of 5 cm, only with appliances with special door technology (connected door technology, varioHinge, etc.)</b> <i>The base unit door including intermediate shelf and removable compensation panel (in carcase decor) will be delivered for on-site adjustment.</i></p>												
		<b>UT 45 85 03</b>		247	254	268	278	389	414	466	513	-	
		<b>Extra charge for MP-GSN...</b>		265	265	265	265	265	265	265	265	265	
		<b>UT 60 85 03</b>		247	254	268	278	389	414	466	513	-	



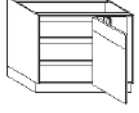
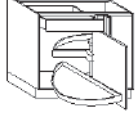
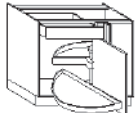
# Corner base units 84.5 cm high variable

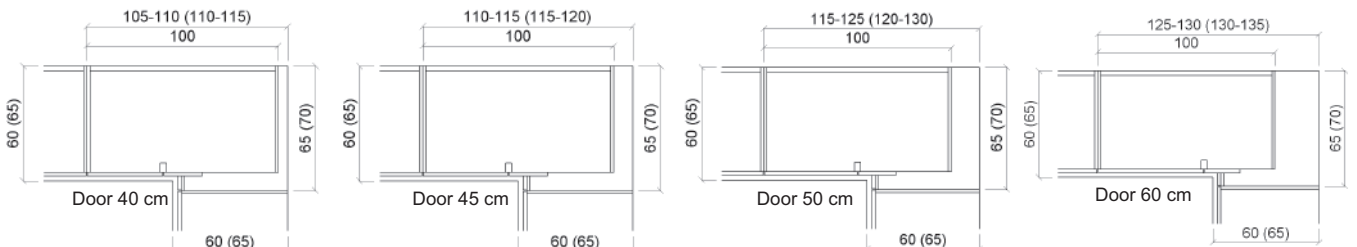
Carcase depth 55.5 cm (standard)

■ = Models also available in 34/45.5/61 cm carcass depth (Order no.: ... replace ... 55 ... with 34/45/61)  
 ▲ = Types also available with 61 cm carcass depth (order no. ... replace ... 55 ... with 61)

Order no.  
 W H D

Hinge side:	Carcass depth	Price groups								
		1	2	3	4	5	6	7	8	9

126 711  Ill. right	<b>Corner base unit, variable</b> Blind section left or right 1 drawer 12.6 cm 1 door 71.1 cm 2 adjustable shelves Carcase width 100 cm with loose corner filler	⚡ Items in ALU TEC RP model are only available with a fixed corner angle min. 6 x 6 cm. Handle N700/775: with fixed corner angle.																	
	Door 40 cm	UE 105 85 55 10	R/L ■	302	310	339	419	500	532	579	637	-							
	Door 45 cm	UE 110 85 55 10	R/L ■	302	310	339	419	500	532	579	637	-							
	Door 50 cm	UE 115 85 55 10	R/L ■	302	310	339	419	500	532	579	637	-							
	Door 60 cm	UE 125 85 55 10	R/L ■	302	311	341	453	542	571	625	688	-							
	<b>Extra charge for extending corner filler width</b>	PLV		24,20	25,10	25,10	34	34	34	34	37	-							
841  Ill. right	<b>Corner base unit, variable</b> Blind section left or right 1 door 84.1 cm 2 adjustable shelves Carcase width 100 cm with loose corner filler	⚡ Items in ALU TEC RP model are only available with a fixed corner angle min. 6 x 6 cm. Handle N700/775: with fixed corner angle.																	
	Door 40 cm	UE 105 85 55 70	R/L ■	268	276	307	385	466	496	549	604	-							
	Door 45 cm	UE 110 85 55 70	R/L ■	268	276	307	385	466	496	549	604	-							
	Door 50 cm	UE 115 85 55 70	R/L ■	268	276	307	385	466	496	549	604	-							
	Door 60 cm	UE 125 85 55 70	R/L ■	268	277	310	421	508	538	594	653	-							
	<b>Extra charge for extending corner filler width</b>	PLV		24,20	25,10	25,10	34	34	34	34	37	-							
126 711  Ill. right	<b>Corner base unit, variable</b> Blind section left or right 1 panel 12.6 cm attached to 1 front 71.1 cm 2 adjustable shelves Carcase width 100 cm with loose corner filler	⚡ Items in ALU TEC RP model are only available with a fixed corner angle min. 6 x 6 cm. Handle N700/775: with fixed corner angle.																	
	Door 40 cm	UE 105 85 55 60	R/L ■	268	276	307	385	466	496	549	604	-							
	Door 45 cm	UE 110 85 55 60	R/L ■	268	276	307	385	466	496	549	604	-							
	Door 50 cm	UE 115 85 55 60	R/L ■	268	276	307	385	466	496	549	604	-							
	Door 60 cm	UE 125 85 55 60	R/L ■	268	277	310	421	508	538	594	653	-							
	<b>Extra charge for extending corner filler width</b>	PLV		24,20	25,10	25,10	34	34	34	34	37	-							
126 711  Ill. right	<b>Corner base unit, variable</b> Blind section left or right 1 drawer 12.6 cm 1 door 71.1 cm 2 carousel shelves Carcase width 100 cm with loose corner filler	⚡ Items in ALU TEC RP model are only available with a fixed corner angle min. 6 x 6 cm. Handle N700/775: with fixed corner angle.																	
	Door 45 cm	UE 110 85 55 12	R/L ▲	341	355	387	465	553	583	634	697	-							
	Door 50 cm	UE 115 85 55 12	R/L ▲	341	355	387	465	553	583	634	697	-							
	Door 60 cm	UE 125 85 55 12	R/L ▲	341	361	390	502	594	624	681	749	-							
		<b>Extra charge for extending corner filler width</b>	PLV		24,20	25,10	25,10	34	34	34	34	37	-						
126 711  Ill. right	<b>Corner base unit, variable</b> Blind section left or right 1 drawer 12.6 cm 1 door 71.1 cm 2 wooden carousel shelves with chrome-plated rail. Carcase width 100 cm With loose corner filler	⚡ Items in ALU TEC RP model are only available with a fixed corner angle min. 6 x 6 cm. Handle N700/775: with fixed corner angle.																	
	Door 45 cm	UE 110 85 55 13	R/L ▲	432	447	478	555	642	673	723	795	-							
	Door 50 cm	UE 115 85 55 13	R/L ▲	432	447	478	555	642	673	723	795	-							
	Door 60 cm	UE 125 85 55 13	R/L ▲	432	451	481	589	682	712	767	844	-							
		<b>Extra charge for extending corner filler width</b>	PLV		24,20	25,10	25,10	34	34	34	34	37	-						



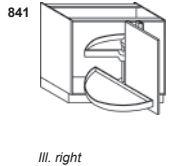
# Corner base units 84.5 cm high variable

Carcase depth 55.5 cm (standard)

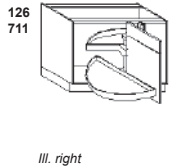
■ = Models also available in 34/45.5/61 cm carcass depth (Order no.: ... replace ... 55 ... with 34/45/61)  
 ▲ = Types also available with 61 cm carcass depth (order no. ... replace ... 55 ... with 61)

Order no.  
W H D

Hinge side:	Carcass depth	Price groups								
		1	2	3	4	5	6	7	8	9
Items in ALU TEC RP model are only available with a fixed corner angle min. 6 x 6 cm. Handle N700/775: with fixed corner angle.										
R/L ▲	400	419	444	524	613	641	690	759	-	-
R/L ▲	400	419	444	524	613	641	690	759	-	-
R/L ▲	400	421	447	561	648	681	737	811	-	-
PLV		24,20	25,10	25,10	34	34	34	34	37	-



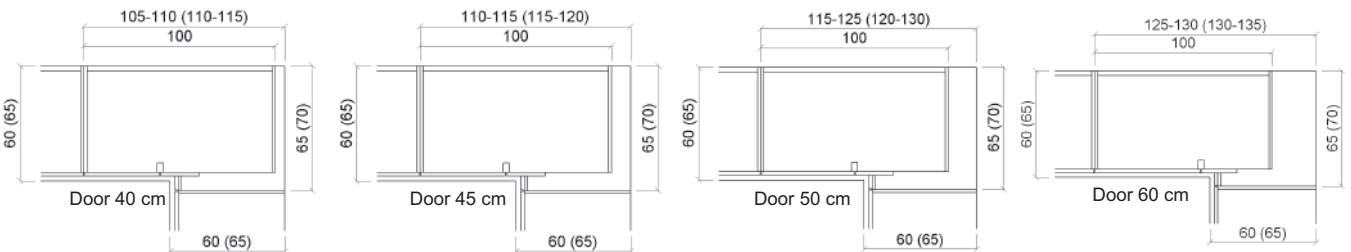
**Corner base unit, variable**  
 Blind section left or right  
 1 door 84.1 cm  
 2 wooden carousel shelves with chrome-plated rail  
 Carcase width 100 cm with loose corner filler  
 Door 45 cm  
 Door 50 cm  
 Door 60 cm



**Corner base unit, variable**  
 Blind section left or right  
 1 panel 12.6 cm attached to  
 1 front 71.1 cm  
 2 wooden carousel shelves with chrome-plated rail  
 Carcase width 100 cm with loose corner filler  
 Door 45 cm  
 Door 50 cm  
 Door 60 cm

UE	110	85	55	73	R/L ▲	400	419	444	524	613	641	690	759	-
UE	115	85	55	73	R/L ▲	400	419	444	524	613	641	690	759	-
UE	125	85	55	73	R/L ▲	400	421	447	561	648	681	737	811	-

PLV 24,20 25,10 25,10 34 34 34 34 37 -



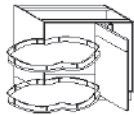
# Corner base units 84.5 cm high Le Mans


Carcase depth 55.5 cm (standard)

▲ = Types also available with 61 cm carcass depth (order no. ... replace ... 55 ... with 61)

Order no.  
W H D

Hinge side:	Carcass depth	Price groups								
		1	2	3	4	5	6	7	8	9

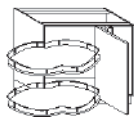
**126 711**  **Corner base unit „Le Mans“**  
Blind section left or right  
1 panel 12.6 cm attached to  
1 door 71.1 cm connected  
2 wooden carousel shelves with chrome-plated rail  
fully swivelling „Le Mans“  
Carcass width 100 cm with loose corner filler  
Door 45 cm  
Door 50 cm  
Door 60 cm


 **Note:** Please allow for shelf turning space and 50 cm clearance for carousel shelves. Items in ALU TEC RP model are only available with a fixed corner angle min. 6 x 6 cm. Handle N700/775: with fixed corner angle.

<b>UE 110 85 55 64</b>	R/L ▲	926	934	966	1028	1115	1138	1193	1312	-
<b>UE 115 85 55 64</b>	R/L ▲	965	973	1002	1063	1148	1174	1226	1349	-
<b>UE 125 85 55 64</b>	R/L ▲	1011	1020	1054	1145	1233	1266	1319	1451	-

**Extra charge for extending corner filler width**

<b>PLV</b>		24,20	25,10	25,10	34	34	34	34	37	-
------------	--	-------	-------	-------	----	----	----	----	----	---


**841**  **Corner base unit „Le Mans“**  
Blind section left or right  
1 door 84.1 cm  
2 wooden carousel shelves with chrome-plated rail  
fully swivelling „Le Mans“  
Carcass width 100 cm with loose corner filler  
Door 45 cm  
Door 50 cm  
Door 60 cm


 **Note:** Please allow for shelf turning space and 50 cm clearance for carousel shelves. Items in ALU TEC RP model are only available with a fixed corner angle min. 6 x 6 cm. Handle N700/775: with fixed corner angle.

<b>UE 110 85 55 74</b>	R/L ▲	926	934	966	1028	1115	1138	1193	1312	-
<b>UE 115 85 55 74</b>	R/L ▲	965	973	1002	1063	1148	1174	1226	1349	-
<b>UE 125 85 55 74</b>	R/L ▲	1011	1020	1054	1145	1233	1266	1319	1451	-

**Extra charge for extending corner filler width**

<b>PLV</b>		24,20	25,10	25,10	34	34	34	34	37	-
------------	--	-------	-------	-------	----	----	----	----	----	---

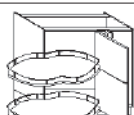
**126 711**  **Corner base unit „Le Mans“**  
Blind section left or right  
1 drawer 12.6 cm, 1 door 71.1 cm  
2 wooden carousel shelves with chrome-plated rail  
fully swivelling „Le Mans“  
Carcass width 100 cm with loose corner filler  
Door 45 cm  
Door 50 cm  
Door 60 cm


 **Note:** Please allow for shelf turning space and 50 cm clearance for carousel shelves. Items in ALU TEC RP model are only available with a fixed corner angle min. 6 x 6 cm. Handle N700/775: with fixed corner angle.

<b>UE 110 85 55 14</b>	R/L ▲	959	969	999	1061	1142	1172	1224	1346	-
<b>UE 115 85 55 14</b>	R/L ▲	996	1004	1036	1097	1180	1208	1260	1386	-
<b>UE 125 85 55 14</b>	R/L ▲	1046	1055	1087	1179	1268	1295	1350	1485	-

**Extra charge for extending corner filler width**

<b>PLV</b>		24,20	25,10	25,10	34	34	34	34	37	-
------------	--	-------	-------	-------	----	----	----	----	----	---


**386 451**  **Corner base unit „Le Mans“**  
Blind section left or right  
1 door consisting of  
2 panels 38.6 cm and 45.1 cm  
attached 2 wooden carousel shelves with chrome-plated rail  
fully swivelling „Le Mans“  
Carcass width 100 cm with loose corner filler  
Door 45 cm  
Door 50 cm  
Door 60 cm

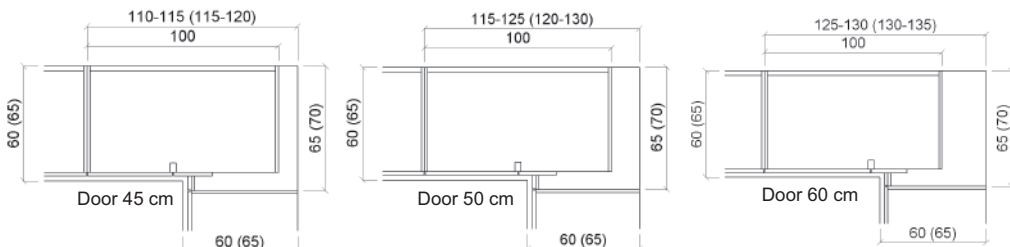
 **Note:** Please allow for shelf turning space and 50 cm clearance for carousel shelves. Items in ALU TEC RP model are only available with a fixed corner angle min. 6 x 6 cm. Handle N700/775: with fixed corner angle.

<b>UE 110 85 55 742</b>	R/L ▲	926	935	965	1027	1114	1140	1190	1309	-
<b>UE 115 85 55 742</b>	R/L ▲	964	973	1002	1064	1148	1174	1226	1349	-
<b>UE 125 85 55 742</b>	R/L ▲	1012	1021	1054	1145	1233	1265	1319	1451	-

 **Cushioned self-closing mechanism for „Le Mans“ carousel shelves**

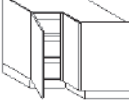
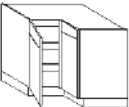
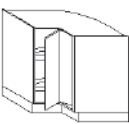
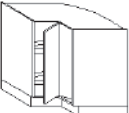
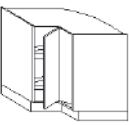
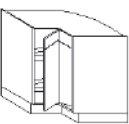
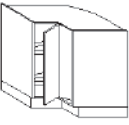
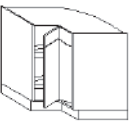
<b>Z 142</b>	R/L	41								
--------------	-----	----	--	--	--	--	--	--	--	--

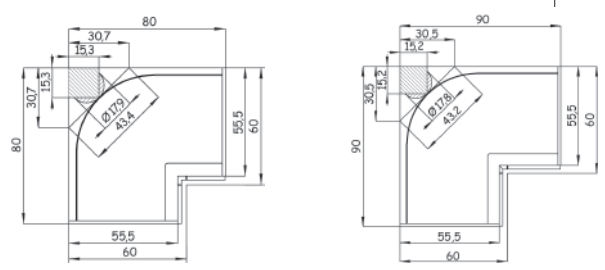
 **Important!**  
Version L = left suitable for unit types in the version L=left  
Version R = right suitable for unit types in the version R=right



# Corner base units as carousel corner unit 84.5 cm high

Carcase depth 55.5 cm (standard)

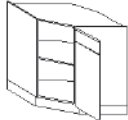
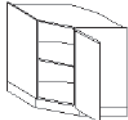
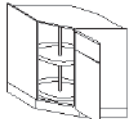
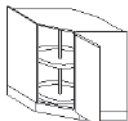
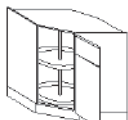
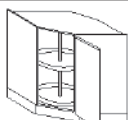
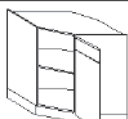
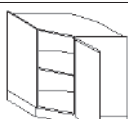
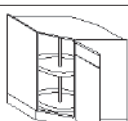
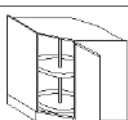
		Order no.		Price groups									
		W	H	D	1	2	3	4	5	6	7	8	9
841	 <p><b>Corner base unit with shelves</b> side length 90 x 90 cm 2 adjustable shelves 2 doors 30 cm wide, 84.1 cm high Right door with corner angle 4.2 cm x 4.2 cm</p>	<b>PTO</b>	<b>UEB 90 85 70</b>		582	602	655	731	731	749	816	898	-
			Not available for: ALU TEC RP, MIAMI, VIVA										
126 711	 <p><b>Corner base unit with shelves</b> side length 90 x 90 cm 2 adjustable shelves 2 panels 12.6 cm attached to 2 doors 71.1 cm 30 cm wide Right door with corner angle 4.2 cm x 4.2 cm</p>	<b>PTO</b>	<b>UEB 90 85 60</b>		582	602	655	731	731	749	816	898	-
			Not available for: ALU TEC RP, MIAMI, VIVA										
841	 <p><b>Corner base unit as carousel corner unit</b> side length 80 x 80 cm 2 wooden carousel shelves with chrome-plated rail with 360° rotation mechanism 2 doors 20 cm wide, 84.1 cm high (doors attached to front panels not possible) Right door with corner angle 4.2 x 4.2 cm</p>	<b>PTO</b>	<b>UEK 80 85 73</b>		776	797	850	924	924	941	1005	1106	-
			Not available for: ALU TEC RP, MPX										
			<b>Model ALU TEC RP:</b> The doors are different for technical reasons: left door 21.8 cm, right door 24.1 cm without corner angle, with handle N700/775, left door 21.8 cm, right door 24.1 cm without corner angle. width 20 cm: FRAME, VILLAGE 15-S, VILLAGE 15-B, CHALET-S, CHALET-B, OSLO 15, TESSIN 15, BERGEN, LUGANO, CASTELLO, VIVA, TIM 15 are supplied with smooth fronts.										
841	 <p><b>Corner base unit as carousel corner unit</b> side length 80 x 80 cm 2 carousel shelves with 360° rotation mechanism 2 doors 20 cm wide, 84.1 cm high (doors attached to front panels not possible) Right door with corner angle 4.2 x 4.2 cm</p>	<b>PTO</b>	<b>UEK 80 85 72</b>		582	601	655	731	731	749	815	897	-
			Not available for: ALU TEC RP, MPX										
			<b>Model ALU TEC RP:</b> The doors are different for technical reasons: left door 21.8 cm, right door 24.1 cm without corner angle, with handle N700/775, left door 21.8 cm, right door 24.1 cm without corner angle. width 20 cm: FRAME, VILLAGE 15-S, VILLAGE 15-B, CHALET-S, CHALET-B, OSLO 15, TESSIN 15, BERGEN, LUGANO, CASTELLO, VIVA, TIM 15 are supplied with smooth fronts.										
841	 <p><b>Corner base unit as carousel corner unit</b> side length 90 x 90 cm 2 wooden carousel shelves with chrome-plated rail with 360° rotation mechanism 2 doors 30 cm wide, 84.1 cm high Right door with corner angle 4.2 x 4.2 cm</p>	<b>PTO</b>	<b>UEK 90 85 73</b>		776	797	850	924	924	941	1005	1106	-
			Not available for: ALU TEC RP, MPX										
			<b>Model ALU TEC RP:</b> The doors are different for technical reasons: left door 21.8 cm, right door 24.1 cm without corner angle, with handle N700/775, left door 31.8 cm, right door 34.1 cm without corner angle.										
126 711	 <p><b>Corner base unit as carousel corner unit</b> side length 90 x 90 cm 2 wooden carousel shelves with chrome-plated rail 2 panels 12.6 cm attached to 2 doors 71.1 cm 30 cm wide Right door with corner angle 4.2 x 4.2 cm</p>	<b>PTO</b>	<b>UEK 90 85 63</b>		776	797	850	924	924	941	1005	1106	-
			Not available for: ALU TEC RP										
			<b>Model ALU TEC RP:</b> Not available for: N700, N775										
841	 <p><b>Corner base unit as carousel corner unit</b> side length 90 x 90 cm 2 carousel shelves with 360° rotation mechanism 2 doors 30 cm wide, 84.1 cm high Right door with corner angle 4.2 cm x 4.2 cm</p>	<b>PTO</b>	<b>UEK 90 85 72</b>		582	601	655	731	731	749	815	897	-
			Not available for: ALU TEC RP, MPX										
			<b>Model ALU TEC RP:</b> The doors are different for technical reasons: left door 21.8 cm, right door 24.1 cm without corner angle, with handle N700/775, left door 31.8 cm, right door 34.1 cm without corner angle.										
126 711	 <p><b>Corner base unit as carousel corner unit</b> side length 90 x 90 cm 2 carousel shelves with 360° rotation mechanism 2 panels 12.6 cm attached to 2 doors 71.1 cm 30 cm wide Right door with corner angle 4.2 cm x 4.2 cm</p>	<b>PTO</b>	<b>UEK 90 85 62</b>		582	601	655	731	731	749	815	897	-
			Not available for: ALU TEC RP										
			<b>Model ALU TEC RP:</b> Not available for: N700, N775										

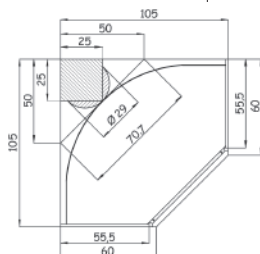
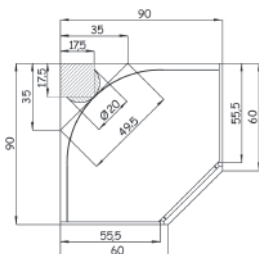




# Diagonal corner base unit 84.5 cm high

Carcase depth 55.5 cm (standard)

		Order no.		Hinge side:	Carcase depth	Price groups								
		W	H			D	1	2	3	4	5	6	7	8
126 711		<b>Diagonal corner base unit</b> 90 x 90 cm, inside depth 72.5 cm 1 panel 12.6 cm attached to 1 door 71.1 cm 40 cm wide 1 adjustable shelf	<b>PTO</b>	<b>UED 90 85 60</b>	R/L	639	649	664	719	755	773	811	892	-
				Not available for: ALU TEC RP										
841		<b>Diagonal corner base unit</b> 90 x 90 cm, inside depth 72.5 cm 1 door 40 cm wide, 84.1 cm high 1 adjustable shelf	<b>PTO</b>	<b>UED 90 85 70</b>	R/L	639	649	664	719	755	773	811	892	-
				Not available for: ALU TEC RP										
126 711		<b>Diagonal carousel corner base unit</b> 90 x 90 cm, inside depth 72.5 cm 1 panel 12.6 cm attached to 1 door 71.1 cm 40 cm wide 2 carousel shelves	<b>PTO</b>	<b>UED 90 85 62</b>	R/L	703	714	734	783	820	838	876	964	-
				Not available for: ALU TEC RP										
841		<b>Diagonal carousel corner base unit</b> 90 x 90 cm, inside depth 72.5 cm 1 door 40 cm wide, 84.1 cm high 2 carousel shelves	<b>PTO</b>	<b>UED 90 85 72</b>	R/L	703	714	734	783	820	838	876	964	-
				Not available for: ALU TEC RP										
126 711		<b>Diagonal carousel corner base unit</b> 90 x 90 cm, inside depth 72.5 cm 1 panel 12.6 cm attached to 1 door 71.1 cm 40 cm wide 2 wooden carousel shelves with chrome-plated rail	<b>PTO</b>	<b>UED 90 85 63</b>	R/L	899	912	928	974	1009	1032	1065	1172	-
				Not available for: ALU TEC RP										
841		<b>Diagonal carousel corner base unit</b> 90 x 90 cm, inside depth 72.5 cm 1 door 40 cm wide, 84.1 cm high 2 wooden carousel shelves with chrome-plated rail	<b>PTO</b>	<b>UED 90 85 73</b>	R/L	899	912	928	974	1009	1032	1065	1172	-
				Not available for: ALU TEC RP										
126 711		<b>Diagonal corner base unit</b> 105 x 105 cm, inside depth 72.5 cm 1 panel 12.6 cm attached to 1 door 71.1 cm 60 cm wide 1 adjustable shelf	<b>PTO</b>	<b>UED 105 85 60</b>	R/L	672	685	703	762	800	827	865	952	-
				Not available for: ALU TEC RP, MIAMI, VIVA										
841		<b>Diagonal corner base unit</b> 105 x 105 cm, inside depth 72.5 cm 1 door 60 cm wide, 84.1 cm high 1 adjustable shelf	<b>PTO</b>	<b>UED 105 85 70</b>	R/L	672	685	703	762	800	827	865	952	-
				Not available for: ALU TEC RP, MIAMI, VIVA										
126 711		<b>Diagonal carousel corner base unit</b> 105 x 105 cm, inside depth 72.5 cm 1 panel 12.6 cm attached to 1 door 71.1 cm 60 cm wide 2 carousel shelves	<b>PTO</b>	<b>UED 105 85 62</b>	R/L	739	750	772	829	869	889	930	1023	-
				Not available for: ALU TEC RP, MIAMI, VIVA										
841		<b>Diagonal carousel corner base unit</b> 105 x 105 cm, inside depth 72.5 cm 1 door 60 cm wide, 84.1 cm high 2 carousel shelves	<b>PTO</b>	<b>UED 105 85 72</b>	R/L	739	750	772	829	869	889	930	1023	-
				Not available for: ALU TEC RP, MIAMI, VIVA										





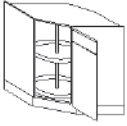
# Diagonal corner base unit 84.5 cm high

Carcase depth 55.5 cm (standard)

Order no.  
W H D

Hinge side:	Carcase depth	Price groups								
		1	2	3	4	5	6	7	8	9
R/L		933	949	968	1021	1058	1082	1120	1232	-

126  
711

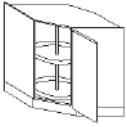


**Diagonal carousel corner base unit**  
105 x 105 cm, inside depth 72.5 cm  
1 panel 12.6 cm attached to 1 door 71.1 cm  
60 cm wide  
2 wooden carousel shelves with chrome-plated rail



**UED 105 85 63**  
Not available for:  
ALU TEC RP, MIAMI, VIVA

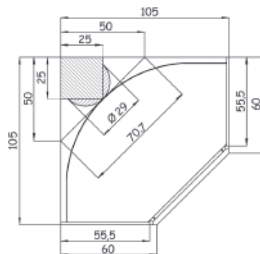
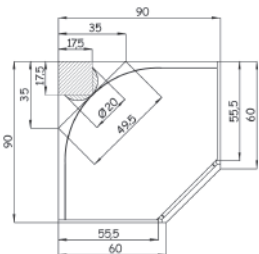
841



**Diagonal carousel corner base unit**  
105 x 105 cm, inside depth 72.5 cm  
1 door 60 cm wide, 84.1 cm high  
2 wooden carousel shelves with chrome-plated rail



**UED 105 85 73**  
Not available for:  
ALU TEC RP, MIAMI, VIVA

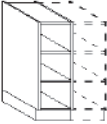



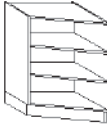





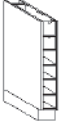


# Base shelf units 84.5 cm high

Carcase depth 57.7 cm, flush with front

- = Models also available in 36.1/47.7/63.2 cm carcass depth  
(Order no.: replace ... 58 ... with 36/48/63)
- = Models also available in 47.7 cm carcass depth (order no.: replace ... 58 ... with 48)
- ▲ = Types also available with 63.2 cm carcass depth (order no. ... replace ... 58 ... with 63)

Order no.  
W H D

	Hinge side:	Carcass depth	Decor groups													
			M10	M20	M30	M40	M50	M60	M70	M80	M90					
 <p><b>Base shelf unit</b> 2 adjustable shelves wide in cm: 13-30 wide in cm: 30,1-40 wide in cm: 40,1-45 wide in cm: 45,1-50 wide in cm: 50,1-60 wide in cm: 60,1-80 wide in cm: 80,1-90</p>		36,1 47,7 57,7 63,2	UR	30	85	58	■	212	-	-	-	783	-	783	783	-
			UR	40	85	58	■	212	-	-	-	783	-	783	783	-
			UR	45	85	58	■	212	-	-	-	783	-	783	783	-
			UR	50	85	58	■	212	-	-	-	783	-	783	783	-
			UR	60	85	58	■	212	-	-	-	783	-	783	783	-
			UR	80	85	58	■	241	-	-	-	847	-	1088	1088	-
			UR	90	85	58	■	241	-	-	-	847	-	1088	1088	-
 <p><b>Base unit bottle shelf</b> 15 cm wide, with 6 compartments</p>			URFL	15	85	58	□	230	-	-	-	675	-	675	675	-
 <p><b>Base unit bottle shelf</b> 30 cm wide, 1 central partition, thus 12 compartments</p>			URFL	30	85	58	□	351	-	-	-	860	-	860	860	-
 <p><b>Base shelf unit</b> 1 towel rails With 2 extendable rails</p>			URH	15	85	58	▲	259	-	-	-	776	-	776	776	-
	URH	20	85	58	▲	259	-	-	-	776	-	776	776	-		
	URH	25	85	58	▲	259	-	-	-	776	-	776	776	-		
 <p><b>Base shelf unit 15 - 60 cm</b> Shelves angled at front, 2 fixed shelves</p>			URS	00	85	58	R/L ■	285	-	-	-	1109	-	1109	1109	-
	 <i>Important! Please state right and left carcass depth (minimum depth 10 cm)</i>															
 <p><b>Base shelf end unit</b> 25 x 57.7 cm 2 fixed shelves 1 plinth panel, separate For adjacent fitting left or right</p>			URA	25	85	58	R/L ■	217	-	-	-	607	-	607	607	-
	 <i>Important! Only available in 25 cm width. Worktop length 27.3 cm</i>															
 <p><b>Base shelf end unit</b> 34 x 57.7 cm 2 fixed shelves 1 plinth panel, separate For adjacent fitting left or right</p>			URA	34	85	58	R/L ■	217	-	-	-	707	-	707	707	-
	 <i>Important! Worktop length 36.3 cm</i>															
 <p><b>Base shelf unit for containers</b> 15 cm wide Prepared for 5 containers Back panel set forward to 43.1 cm depth</p>			URSK	15	85	58	□	230	-	-	-	675	-	675	675	-

M 10	M 20	M 30	M 40	M 50
K M10 laminate				B M50 Velvet lacquer S M50 microstructure lacquer
M 60	M 70	M 80	M 90	
	F M70 veneer / oak / walnut Z M70 Veneer / Bavaria	H M80 high gloss-Lacquer MP M80 laqué mat Premium		

## Base shelf units 84.5 cm high

Carcase depth 57.7 cm, flush with front

■ = = Models also available in 36.1/47.7/63.2 cm carcass depth  
(Order no.: replace ... 58 ... with 36/48/63)

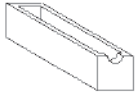
□ = Models also available in 47.7 cm carcass depth (order no.: replace ... 58 ... with 48)

▲ = Types also available with 63.2 cm carcass depth (order no. ... replace ... 58 ... with 63)

Order no.

W H D

Hinge side:	Carcass depth	Decor groups								
		M10	M20	M30	M40	M50	M60	M70	M80	M90
		-	-	-	-	161	-	161	-	-



**Container**  
11 cm high,  
for 15 cm wide base shelf unit

SKU 15 13

M 10	M 20	M 30	M 40	M 50
				B M50 Velvet Lacquer S M50 Microstructure Lacquer
M 60	M 70	M 80	M 90	
	F M70 veneer / oak / walnut			

## Base shelf units 84.5 cm high

Carcass depth 57.7 cm, flush with front

■ = = Models also available in 36.1/47.7/63.2 cm carcass depth  
(Order no.: replace ... 58 ... with 36/48/63)

Order no.

W H D

Hinge side:	Carcass depth	Price groups								
		1	2	3	4	5	6	7	8	9
■	URIF 45 85 58 IA3K	755	767	808	897	1004	1096	1133	1246	-
	URIF 45 85 58 IA3B	1325	1339	1380	1467	1575	1667	1704	1874	-
	URIF 45 85 58 IA3F	1325	1339	1380	1467	1575	1667	1704	1874	-
	URIF 45 85 58 IA3S	1325	1339	1380	1467	1575	1667	1704	1874	-
	URIF 45 85 58 IA3Z	1325	1339	1380	1467	1575	1667	1704	1874	-
■	URIF 60 85 58 IA3K	791	815	859	950	1082	1150	1204	1324	-
	URIF 60 85 58 IA3B	1362	1386	1430	1522	1653	1720	1776	1954	-
	URIF 60 85 58 IA3F	1362	1386	1430	1522	1653	1720	1776	1954	-
	URIF 60 85 58 IA3S	1362	1386	1430	1522	1653	1720	1776	1954	-
	URIF 60 85 58 IA3Z	1362	1386	1430	1522	1653	1720	1776	1954	-
■	URIF 90 85 58 IA3K	983	1078	1088	1189	1352	1464	1522	1674	-
	URIF 90 85 58 IA3B	1589	1683	1693	1795	1958	2068	2126	2339	-
	URIF 90 85 58 IA3F	1589	1683	1693	1795	1958	2068	2126	2339	-
	URIF 90 85 58 IA3S	1589	1683	1693	1795	1958	2068	2126	2339	-
	URIF 90 85 58 IA3Z	1589	1683	1693	1795	1958	2068	2126	2339	-
■	URIF 45 85 58 IS4K	745	749	759	862	979	1002	1039	1143	-
	URIF 45 85 58 IS4B	1317	1321	1329	1433	1551	1573	1610	1771	-
	URIF 45 85 58 IS4F	1317	1321	1329	1433	1551	1573	1610	1771	-
	URIF 45 85 58 IS4S	1317	1321	1329	1433	1551	1573	1610	1771	-
	URIF 45 85 58 IS4Z	1317	1321	1329	1433	1551	1573	1610	1771	-
■	URIF 60 85 58 IS4K	772	777	794	907	1029	1088	1137	1251	-
	URIF 60 85 58 IS4B	1343	1347	1365	1479	1601	1660	1709	1880	-
	URIF 60 85 58 IS4F	1343	1347	1365	1479	1601	1660	1709	1880	-
	URIF 60 85 58 IS4S	1343	1347	1365	1479	1601	1660	1709	1880	-
	URIF 60 85 58 IS4Z	1343	1347	1365	1479	1601	1660	1709	1880	-
■	URIF 90 85 58 IS4K	909	932	946	1085	1217	1297	1357	1493	-
	URIF 90 85 58 IS4B	1514	1537	1551	1691	1822	1903	1962	2158	-
	URIF 90 85 58 IS4F	1514	1537	1551	1691	1822	1903	1962	2158	-
	URIF 90 85 58 IS4S	1514	1537	1551	1691	1822	1903	1962	2158	-
	URIF 90 85 58 IS4Z	1514	1537	1551	1691	1822	1903	1962	2158	-



Not available for:

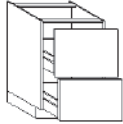
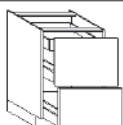

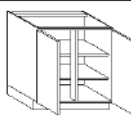
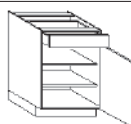
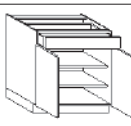

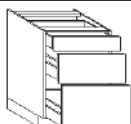
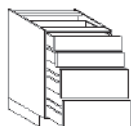
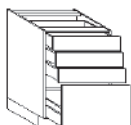
ALU TEC RP, ALUELEMENTS, ATLANTA-B, ATLANTA-S, BERGEN, CASTELLO, CHALET-B, CHALET-S, CHICAGO, FRAME, GENT, INTARSIA, LUGANO, LUX-B, MIAMI, NOBEL-B, NOBEL-S, OPAL-H, ORLANDO-B, ORLANDO-S, OSLO 15, PALERMO-B, PALERMO-S, ROMA-B, ROMA-S, SOFIE-B, SOFIE-S, STRIP ELEMENTS, TALEA, TESSIN 15, TIM 15, VILLAGE 15-B, VILLAGE 15-S, VINO, VIVA, YORK-B, YORK-S

M 10	M 20	M 30	M 40	M 50
K M10 laminate				B M50 Velvet Lacquer S M50 Microstructure Lacquer
M 60	M 70	M 80	M 90	
	F M70 veneer / oak / walnut Z M70 Veneer / Bavaria			





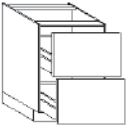
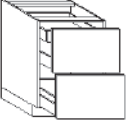



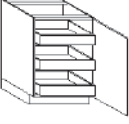

# Base units 84.5 cm high

Carcase depth 70.5 cm

		Order no.	W	H	D	Hinge side:	Carcase depth	Price groups										
								1	2	3	4	5	6	7	8	9		
451 386		<b>Base unit</b> 1 pull-out 45.1 cm 1 internal drawer 1 pull-out 38.6						<b>U 30 85 70 085</b>	632	641	694	738	738	761	812	893	-	
								<b>U 40 85 70 085</b>	632	641	694	738	738	761	812	893	-	
								<b>U 45 85 70 085</b>	632	641	694	738	738	761	812	893	-	
								<b>U 50 85 70 085</b>	632	641	694	738	738	761	812	893	-	
								<b>U 70 85 70 085</b>	946	961	1047	1129	1142	1197	1295	1425	-	
								<b>U 60 85 70 085</b>	663	673	722	788	788	817	876	964	-	
								<b>U 80 85 70 085</b>	946	961	1047	1129	1142	1197	1295	1425	-	
								<b>U 90 85 70 085</b>	946	961	1047	1129	1142	1197	1295	1425	-	
<b>U 100 85 70 085</b>	961	985	1068	1155	1171	1225	1327	1460	-									
451 386		<b>Base unit</b> 1 internal drawer 1 pull-out 45.1 cm 1 pull-out 38.6						<b>U 30 85 70 086</b>	721	731	780	825	825	847	896	986	-	
								<b>U 40 85 70 086</b>	721	731	780	825	825	847	896	986	-	
								<b>U 45 85 70 086</b>	721	731	780	825	825	847	896	986	-	
								<b>U 50 85 70 086</b>	721	731	780	825	825	847	896	986	-	
								<b>U 60 85 70 086</b>	754	761	812	875	875	900	957	1053	-	
								<b>U 70 85 70 086</b>	1034	1047	1129	1207	1224	1275	1373	1510	-	
								<b>U 80 85 70 086</b>	1034	1047	1129	1207	1224	1275	1373	1510	-	
								<b>U 90 85 70 086</b>	1034	1047	1129	1207	1224	1275	1373	1510	-	
<b>U 100 85 70 086</b>	1057	1078	1165	1249	1265	1320	1423	1565	-									
841		<b>Base unit</b> 1 door 84.1 cm 2 adjustable shelves						<b>U 30 85 70 70</b>	R/L	272	282	311	359	378	390	422	464	-
								<b>U 40 85 70 70</b>	R/L	272	282	311	367	378	396	427	470	-
								<b>U 45 85 70 70</b>	R/L	272	282	311	367	385	410	427	470	-
								<b>U 50 85 70 70</b>	R/L	272	282	311	367	396	425	464	510	-
								<b>U 60 85 70 70</b>	R/L	311	324	337	402	448	476	512	563	-
841		<b>Base unit</b> 2 doors 84.1 cm 2 adjustable shelves						<b>U 80 85 70 70</b>		329	342	373	499	594	629	702	772	-
								<b>U 90 85 70 70</b>		329	342	373	499	594	629	703	773	-
								<b>U 100 85 70 70</b>		347	361	393	522	616	667	757	833	-
								<b>U 120 85 70 70</b>		395	420	469	620	699	744	826	909	-
126 711		<b>Base unit</b> 1 drawer 12.6 cm 1 door 71.1 cm 2 adjustable shelves						<b>U 30 85 70 10</b>	R/L	342	352	381	437	455	473	504	554	-
								<b>U 40 85 70 10</b>	R/L	342	352	381	438	455	478	509	560	-
								<b>U 45 85 70 10</b>	R/L	342	352	381	438	465	489	519	571	-
								<b>U 50 85 70 10</b>	R/L	342	352	381	438	465	492	525	578	-
								<b>U 60 85 70 10</b>	R/L	377	387	420	481	509	538	577	635	-
126 711		<b>Base unit</b> 1 drawer 12.6 cm with full-width panel 2 doors 71.1 cm Left door with buffer strip Without centre panel 2 adjustable shelves						<b>U 80 85 70 10</b>		434	447	476	615	672	704	774	851	-
								<b>U 90 85 70 10</b>		434	447	476	615	672	704	774	851	-
								<b>U 100 85 70 10</b>		443	460	490	625	684	720	791	870	-
								<b>U 120 85 70 10</b>		454	469	500	638	697	735	807	888	-
								 <b>Width 80, 100 Not available for:</b> GENT, INTARSIA, OSLO 15, TESSIN 15, TIM 15, VILLAGE 15-B, VILLAGE 15-S <b>Width 90, 120 Not available for:</b> INTARSIA										
126 321 386		<b>Base unit</b> 1 drawer 12.6 cm 1 pull-out 32.1 cm 1 pull-out 38.6 cm						<b>U 30 85 70 12</b>		672	682	734	778	778	801	850	935	-
								<b>U 40 85 70 12</b>		672	682	734	778	778	801	850	935	-
								<b>U 45 85 70 12</b>		672	682	734	778	778	801	850	935	-
								<b>U 50 85 70 12</b>		672	682	734	778	778	801	850	935	-
								<b>U 60 85 70 12</b>		704	713	763	828	828	854	912	1003	-
								<b>U 80 85 70 12</b>		985	1000	1083	1165	1179	1229	1328	1461	-
								<b>U 70 85 70 12</b>		985	1000	1083	1165	1179	1229	1328	1461	-
								<b>U 90 85 70 12</b>		985	1000	1083	1165	1179	1229	1328	1461	-
								<b>U 100 85 70 12</b>		1008	1035	1119	1203	1218	1273	1378	1516	-
126 256 321		<b>Base unit</b> 2 drawers 12.6 cm 1 pull-out 25.6 cm 1 pull-out 32.1 cm						<b>U 30 85 70 22</b>		746	758	809	850	850	876	926	1019	-
								<b>U 40 85 70 22</b>		746	758	809	850	850	876	926	1019	-
								<b>U 45 85 70 22</b>		746	758	809	850	850	876	926	1019	-
								<b>U 50 85 70 22</b>		746	758	809	850	850	876	926	1019	-
								<b>U 60 85 70 22</b>		782	791	838	899	899	930	987	1086	-
								<b>U 70 85 70 22</b>		1057	1074	1159	1235	1252	1301	1401	1541	-
								<b>U 80 85 70 22</b>		1057	1074	1159	1235	1252	1301	1401	1541	-
								<b>U 90 85 70 22</b>		1057	1074	1159	1235	1252	1301	1401	1541	-
								<b>U 100 85 70 22</b>		1092	1117	1205	1287	1303	1360	1464	1610	-
<b>U 120 85 70 22</b>		1128	1158	1253	1339	1356	1418	1529	1682	-								
126 126 126 451		<b>Base unit</b> 3 drawers 12.6 cm 1 pull-out 45.1 cm						<b>U 30 85 70 31</b>		737	745	767	835	848	875	912	1003	-
								<b>U 40 85 70 31</b>		737	745	767	835	848	875	912	1003	-
								<b>U 45 85 70 31</b>		737	745	767	835	848	875	912	1003	-
								<b>U 50 85 70 31</b>		737	745	767	835	848	875	912	1003	-
								<b>U 60 85 70 31</b>		750	763	783	860	879	908	950	1045	-
								<b>U 70 85 70 31</b>		1008	1028	1109	1185	1203	1252	1350	1485	-
								<b>U 80 85 70 31</b>		1008	1028	1109	1185	1203	1252	1350	1485	-
								<b>U 90 85 70 31</b>		1008	1028	1109	1185	1203	1252	1350	1485	-
								<b>U 100 85 70 31</b>		1046	1067	1158	1237	1254	1310	1415	1557	-

## Base units 84.5 cm high

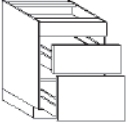
Carcase depth 70.5 cm

	Order no.	W	H	D	Hinge side:	Carcase depth	Price groups														
							1	2	3	4	5	6	7	8	9						
 <p><b>Base unit</b> 4 drawers 12.6 cm 1 pull-out 32.1 cm</p>		U	30	85	70	41		812	823	841	907	923	947	987	1086	-					
							U	40	85	70	41	812	823	841	907	923	947	987	1086	-	
							U	45	85	70	41	812	823	841	907	923	947	987	1086	-	
							U	50	85	70	41	812	823	841	907	923	947	987	1086	-	
							U	60	85	70	41	827	838	856	934	953	983	1022	1124	-	
							U	70	85	70	41	1059	1078	1160	1235	1252	1300	1398	1538	-	
							U	80	85	70	41	1059	1078	1160	1235	1252	1300	1398	1538	-	
							U	90	85	70	41	1059	1078	1160	1235	1252	1300	1398	1538	-	
							U	100	85	70	41	1106	1129	1218	1300	1318	1372	1478	1626	-	
							U	120	85	70	41	1148	1181	1275	1366	1381	1442	1555	1711	-	
 <p><b>Base unit</b> 2 pull-outs 25.6 cm 1 pull-out 32.1 cm</p>		U	30	85	70	03		721	731	780	825	825	847	896	986	-					
							U	40	85	70	03	721	731	780	825	825	847	896	986	-	
							U	45	85	70	03	721	731	780	825	825	847	896	986	-	
							U	50	85	70	03	721	731	780	825	825	847	896	986	-	
							U	60	85	70	03	754	761	812	875	875	900	957	1053	-	
							U	70	85	70	03	1034	1047	1129	1207	1224	1275	1373	1510	-	
							U	80	85	70	03	1034	1047	1129	1207	1224	1275	1373	1510	-	
							U	90	85	70	03	1034	1047	1129	1207	1224	1275	1373	1510	-	
							U	100	85	70	03	1057	1078	1165	1249	1265	1320	1423	1565	-	
							U	120	85	70	03	1082	1111	1200	1287	1301	1362	1470	1617	-	
 <p><b>Base unit</b> 1 pull-out 38.6 cm 1 pull-out 45.1 cm</p>		U	30	85	70	02		632	641	694	738	738	761	812	893	-					
							U	40	85	70	02	632	641	694	738	738	761	812	893	-	
							U	45	85	70	02	632	641	694	738	738	761	812	893	-	
							U	50	85	70	02	632	641	694	738	738	761	812	893	-	
							U	60	85	70	02	663	673	722	788	788	817	876	964	-	
							U	70	85	70	02	946	961	1047	1129	1142	1197	1295	1425	-	
							U	80	85	70	02	946	961	1047	1129	1142	1197	1295	1425	-	
							U	90	85	70	02	946	961	1047	1129	1142	1197	1295	1425	-	
							U	100	85	70	02	961	985	1068	1155	1171	1225	1327	1460	-	
							 <p><b>Base unit</b> 1 pull-out 38.6 cm 1 internal drawer 1 pull-out 45.1 cm</p>		U	30	85	70	022		721	731	780	825	825	847	896
U	40	85	70	022	721	731								780	825	825	847	896	986	-	
U	45	85	70	022	721	731								780	825	825	847	896	986	-	
U	50	85	70	022	721	731								780	825	825	847	896	986	-	
U	60	85	70	022	754	761								812	875	875	900	957	1053	-	
U	70	85	70	022	1034	1047								1129	1207	1224	1275	1373	1510	-	
U	80	85	70	022	1034	1047								1129	1207	1224	1275	1373	1510	-	
U	90	85	70	022	1034	1047								1129	1207	1224	1275	1373	1510	-	
U	100	85	70	022	1057	1078								1165	1249	1265	1320	1423	1565	-	
 <p><b>Base unit</b> consisting of: 2 x 90 cm wide carcasses each with 2 pull-outs Overall carcase width 180 cm 1 full-width panel 38.6 cm high and 179.6 cm wide 1 full-width panel 45.1 cm high and 179.6 cm wide</p>		U	180	85	70	02									1983	2067	2198	2371	2402	2514	2724
 <p><b>Not available for:</b> ALU TEC RP, ALUELEMENTS, ATLANTA-B, ATLANTA-S, BERGEN, CASTELLO, CHALET-B, CHALET-S, CHICAGO, FENIX INOX, FRAME, HPL PRO, INTARSIA, LUGANO, LUX-B, MIAMI, MONTANA, MPX, NEVADA, NOBEL-B, NOBEL-S, ORLANDO-B, ORLANDO-S, PUR, RESOPAL PRO, RESOPAL PRO EDGE, RUSTY OAK, SMART-M, SOFIE-B, SOFIE-S, STRIP ELEMENTS, TALEA, TESSIN 15, TIM, TIM 15, VINO, VIVA, YORK-B, YORK-S</p> <p> <b>Available handles:</b> from a drilling distance of 128 mm <b>Not available with TIP-ON Blumotion</b></p>																					
 <p><b>Base unit</b> 1 door 84.1 cm with wide angle hinges with 3 internal drawers</p>		U	30	85	70	73		R/L	597	605	630	702	714	740	780	858	-				
							U	40	85	70	73	R/L	597	605	630	702	714	740	780	858	-
							U	45	85	70	73	R/L	597	605	630	702	714	740	780	858	-
							U	50	85	70	73	R/L	597	605	630	702	714	740	780	858	-
							U	60	85	70	73	R/L	628	640	668	740	762	789	829	912	-
<p> <b>Planning advice:</b> With door with wide angle hinges - take account of opening angle! Doors with wide angle hinges may not be planned alongside units or panels if the protrusion to the front of the adjoining article is greater than 3 cm (hinge side). Doors with wide angle hinges protrude over the carcase side.</p>																					
<p><b>Planning advice:</b> Take account of opening angle</p>																					

## Hob base units 84.5 cm high

Carcase depth 70.5 cm

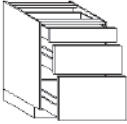
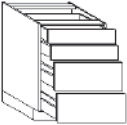
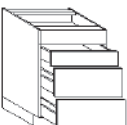
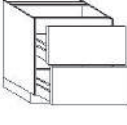
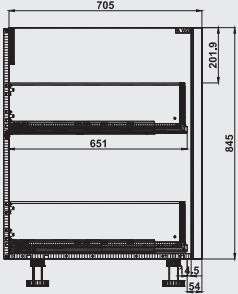
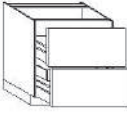
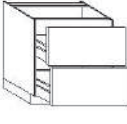
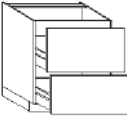
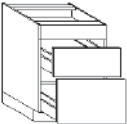
Please follow the fitting instructions from the appliance manufacturers.

 <p><b>Hob base unit</b> 1 panel 12.6 cm 1 cable protective shelf 1 pull-out 25.6 cm 1 pull-out 45.1 cm</p>		UK	60	85	70	82		595	607	656	731	731	763	817	899	-				
							UK	90	85	70	82	866	885	971	992	1009	1059	1161	1277	-
							UK	80	85	70	82	866	885	971	992	1009	1059	1161	1277	-
							UK	100	85	70	82	894	915	1004	1035	1048	1103	1205	1326	-
<p><b>Cutout for control panel</b></p>		UK-AA	22,80																	

# Hob base units 84.5 cm high

Carcase depth 70.5 cm

Please follow the fitting instructions from the appliance manufacturers.

Order no.	W	H	D	Hinge side:	Carcase depth	Price groups														
						1	2	3	4	5	6	7	8	9						
126 321 386 	<b>Hob base unit</b>																			
	1 drawer 12.6 cm but drawer			UKI 60 85 70 12			785	795	836	906	906	934	992	1091	-					
	carcase depth 55.5 cm only with low frame			UKI 70 85 70 12			1061	1078	1163	1242	1255	1306	1406	1547	-					
	1 cable protective shelf			UKI 80 85 70 12			1061	1078	1163	1242	1255	1306	1406	1547	-					
	1 pull-out 32.1 cm 1 pull-out 38.6 cm			UKI 90 85 70 12			1061	1078	1163	1242	1255	1306	1406	1547	-					
			UKI 100 85 70 12			1087	1112	1199	1279	1293	1350	1454	1599	-						
126 126 256 321 	<b>Hob base unit</b>																			
	1 drawer 12.6 cm but drawer			UKI 70 85 70 22			1134	1152	1235	1313	1328	1380	1479	1627	-					
	carcase depth 55.5 cm only with low frame			UKI 80 85 70 22			1134	1152	1235	1313	1328	1380	1479	1627	-					
	1 cable protective shelf			UKI 90 85 70 22			1134	1152	1235	1313	1328	1380	1479	1627	-					
	1 drawer 12.6 cm 1 pull-out 25.6 cm 1 pull-out 32.1 cm			UKI 100 85 70 22			1171	1195	1283	1363	1381	1435	1543	1697	-					
			UKI 120 85 70 22			1207	1233	1329	1417	1432	1496	1604	1764	-						
126 126 256 321 	<b>Hob base unit</b>																			
	1 full-width panel 12.6 cm			UK 70 85 70 81			1032	1046	1133	1208	1227	1279	1381	1519	-					
	1 cable protective shelf			UK 80 85 70 81			1032	1046	1133	1208	1227	1279	1381	1519	-					
	1 drawer 12.6 cm with full-width panel			UK 90 85 70 81			1032	1046	1133	1208	1227	1279	1381	1519	-					
	1 pull-out 25.6 cm with full width panel 1 pull-out 32.1 cm with full width panel			UK 100 85 70 81			1055	1077	1168	1250	1268	1323	1429	1572	-					
			UK 120 85 70 81			1081	1109	1204	1288	1307	1366	1477	1625	-						
386 451 	<b>Hob base unit for hob extractor</b>																			
	1 fixed inside panel			UDK 80 85 70 02			946	961	1047	1129	1142	1197	1295	1425	-					
	1 pull-out 38.6 cm			UDK 90 85 70 02			946	961	1047	1129	1142	1197	1295	1425	-					
	1 pull-out 45.1 cm			UDK 100 85 70 02			961	985	1068	1155	1171	1225	1327	1460	-					
<p><b>Note:</b> The pull-outs are adapted to the respective hob extractor type. We will not assume any liability for damage caused by moisture.</p> 																				
386 451 	<b>Hob base unit for hob extractor</b>																			
	1 fixed inside panel			UDK 80 85 70 082			1034	1047	1129	1207	1224	1275	1373	1510	-					
	1 pull-out 38.6 cm			UDK 90 85 70 082			1034	1047	1129	1207	1224	1275	1373	1510	-					
	1 internal drawer 1 pull-out 45.1 cm			UDK 100 85 70 082			1057	1078	1165	1249	1265	1320	1423	1565	-					
<p><b>Note:</b> The pull-outs are adapted to the respective hob extractor type. We will not assume any liability for damage caused by moisture.</p>																				
386 451 	<b>Hob base unit</b>																			
	1 fixed inside panel			UDK 80 85 70 028			1064	1080	1167	1249	1264	1317	1416	1558	-					
	1 pull-out 38.6 cm with wooden rear panel 1 pull-out 45.1 cm with wooden rear panel			UDK 90 85 70 028			1064	1080	1167	1249	1264	1317	1416	1558	-					
			UDK 100 85 70 028			1080	1106	1188	1274	1290	1345	1445	1590	-						
451 386 	<b>Hob base unit</b>																			
	1 fixed inside panel			UDK 70 85 70 088			1064	1080	1167	1249	1264	1317	1416	1558	-					
	1 pull-out 45.1 cm with wooden rear panel			UDK 80 85 70 088			1064	1080	1167	1249	1264	1317	1416	1558	-					
	1 pull-out 38.6 cm with wooden rear panel			UDK 90 85 70 088			1064	1080	1167	1249	1264	1317	1416	1558	-					
				UDK 100 85 70 088			1080	1106	1188	1274	1290	1345	1445	1590	-					
126 256 451 	<b>Hob base unit for hob extractor</b>																			
	1 panel 12.6 cm			UDK 70 85 70 82			866	885	971	992	1009	1059	1161	1277	-					
	1 pull-out 25.6 cm			UDK 80 85 70 82			866	885	971	992	1009	1059	1161	1277	-					
	1 pull-out 45.1 cm			UDK 90 85 70 82			866	885	971	992	1009	1059	1161	1277	-					
				UDK 100 85 70 82			894	915	1004	1035	1048	1103	1207	1328	-					
<p><b>Note:</b> The pull-outs are adapted to the respective hob extractor type. We will not assume any liability for damage caused by moisture.</p>																				



# Hob base units 84.5 cm high

Carcase depth 70.5 cm

Please follow the fitting instructions from the appliance manufacturers.



## Hob base unit for hob extractor

- 1 panel 12.6 cm
- 1 drawer 12.6 cm
- 1 pull-out 25.6 cm
- 1 pull-out 32.1 cm

126

126

256

321

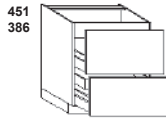
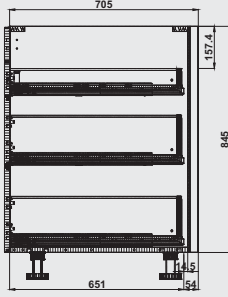
Order no.  
W H D

Hinge side:	Carcase depth	Price groups									
		1	2	3	4	5	6	7	8	9	
		UDK 80 85 70 81	1021	1041	1126	1147	1165	1213	1317	1449	-
		UDK 90 85 70 81	1021	1041	1126	1147	1165	1213	1317	1449	-
		UDK 100 85 70 81	1048	1068	1160	1188	1203	1257	1363	1499	-
		UDK 120 85 70 81	1074	1102	1197	1225	1244	1302	1411	1552	-



### Note:

The pull-outs are adapted to the respective hob extractor type.  
We will not assume any liability for damage caused by moisture.



## Hob base unit for hob extractor

- 1 fixed inside panel
- 1 pull-out 45.1 cm
- 1 internal drawer
- 1 pull-out 38.6 cm

451

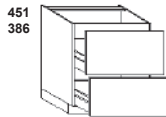
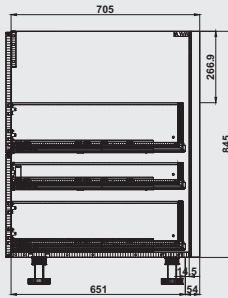
386

		UDK 80 85 70 082	1034	1047	1129	1207	1224	1275	1373	1510	-
		UDK 90 85 70 082	1034	1047	1129	1207	1224	1275	1373	1510	-
		UDK 100 85 70 082	1057	1078	1165	1249	1265	1320	1423	1565	-



### Note:

The pull-outs are adapted to the respective hob extractor type.  
We will not assume any liability for damage caused by moisture.



## Hob base unit for hob extractor

- 1 fixed inside panel
- 1 pull-out 45.1 cm
- 1 pull-out 38.6 cm

451

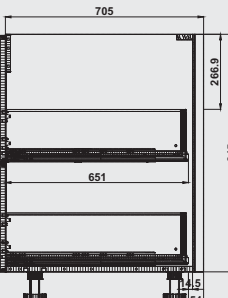
386

		UDK 80 85 70 08	946	961	1047	1129	1142	1197	1295	1425	-
		UDK 90 85 70 08	946	961	1047	1129	1142	1197	1295	1425	-
		UDK 100 85 70 08	961	985	1068	1155	1171	1225	1327	1460	-

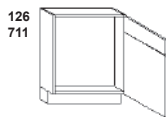


### Note:

The pull-outs are adapted to the respective hob extractor type.  
We will not assume any liability for damage caused by moisture.



## spacefitter frame 84.5 cm high



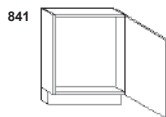
## Base unit spacefitter frame

- 1 panel 12.6 cm attached to
- 1 door 71.1 cm connected
- Carcase depth 10 cm
- For recess cladding

126

711

	R/L	UPR 30 85 10 60	145	153	159	229	246	261	286	315	-
	R/L	UPR 40 85 10 60	145	153	159	229	246	261	286	315	-
	R/L	UPR 45 85 10 60	145	153	159	229	246	261	286	315	-
	R/L	UPR 50 85 10 60	145	153	159	229	246	261	286	315	-
	R/L	UPR 60 85 10 60	169	180	188	260	301	312	345	380	-



## Base unit spacefitter frame



- 1 door 84.1 cm
- Carcase depth 10 cm
- For recess cladding

841



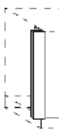


	R/L	UPR 20 85 10 70	145	153	159	229	246	261	286	315	-
	R/L	UPR 25 85 10 70	145	153	159	229	246	261	286	315	-
	R/L	UPR 30 85 10 70	145	153	159	229	246	261	286	315	-
	R/L	UPR 40 85 10 70	145	153	159	229	246	261	286	315	-
	R/L	UPR 45 85 10 70	145	153	159	229	246	261	286	315	-
	R/L	UPR 50 85 10 70	145	153	159	229	246	261	286	315	-
	R/L	UPR 60 85 10 70	169	180	188	260	301	312	345	380	-



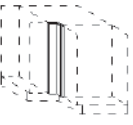






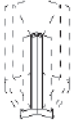


## Background filler 84.5 cm high

		Order no. W H D		Hinge side:	Carcase depth	Decor groups														
						M10	M20	M30	M40	M50	M60	M70	M80	M90						
	<b>Base unit background filler</b> Width: 20 cm For fitting flush with carcass	Unit price																		
		<b>UPSL0085</b>																		
	<b>Base unit corner background fillers</b> For corner solution 105 x 105 cm	Unit price																		
		<b>UWSL 85 1</b>																		
<b>M 10</b>	<b>M 20</b>	<b>M 30</b>	<b>M 40</b>	<b>M 50</b>																
K M10 laminate	D M20 Laminate decor	I M30 RESOPAL PRO super matt IH M30 HPL PRO PW M30 PRIMEWOOD/Basic Veneer	A M40 DIRECTLACK matt L M40 DIRECTLACK high-gloss	B M50 Velvet lacquer P M50 Soft lacquer S M50 microstructure lacquer																
<b>M 60</b>	<b>M 70</b>	<b>M 80</b>	<b>M 90</b>																	
QH M60 SMARTGLAS high-gloss QM M60 SMARTGLAS satin-finish	F M70 veneer / oak / walnut Z M70 Veneer / Bavaria	C1 M80 FENIX stainless-steel look H M80 high gloss-Lacquer MP M80 laqué mat Premium																		


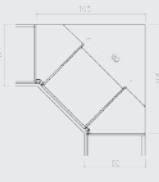

## Front filler 84.5 cm high

		Order no. W H D		Hinge side:	Carcase depth	Price groups															
						1	2	3	4	5	6	7	8	9							
	<b>Base unit front filler</b>  3.5 - 10 cm 10.1 - 20 cm	 <b>Not available for:</b> MIAMI, VIVA																			
		<b>UP 10 85</b>																			
		<b>UP 20 85</b>																			
	<b>Base unit front filler with buffer strip</b> 1 door 84.1 cm 10 - 20 cm	<b>UPA 20 85</b>		R/L																	
		 <b>Not available for:</b> MIAMI, VIVA																			
<b>Base unit intermediate filler</b> 3.5 - 20 cm	<b>UPZ 20 85</b>																				
	 <b>Not available for:</b> MIAMI, VIVA																				


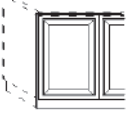
## Corner filler 84.5 cm high

	<b>Base unit corner filler 90°</b>  9.5 x 9.5 cm up to 20 x 20 cm	 <b>Important!</b> Planning dimensions 65 x 65 cm Items can only be fitted in the ALU TEC RP models with a minimum size of 6 x 6 cm.																				
		 <b>Not available for:</b> MIAMI, VIVA																				
		<b>UPW 65 85</b>																				
	<b>Base unit corner filler 90° with grip ledge N700/775</b>  9.5 x 9.5 cm up to 20 x 20 cm	 <b>Important!</b> Planning dimensions 65 x 65 cm																				
		 <b>Not available for:</b> MIAMI, VIVA																				
		<b>UPWN 65 85</b>																				
		Extra charge for N...																				
		<b>UPWN 75 85</b>																				
	<b>Base unit corner filler for variable corner solutions / diagonal solutions</b> min. planning dimension 25.9 cm max. planning dimension 38 cm	Extra charge for N...																				
		<b>UPW 00 85</b>																				
		 <b>Not available for:</b> MIAMI, VIVA																				
		 <b>Important!</b> 2 x model required for diagonal corner solution. <b>Note:</b> Please specify the precise angle and angle leg. With angles less than 90°, please do not plan pull-outs/drawers or dishwashers in the corner.																				



# Corner filler 84.5 cm high

		Price groups											
		Order no.	Hinge side:	Carcase depth	1	2	3	4	5	6	7	8	9
		W H D											
 <p><b>Base unit corner filler 135°</b> For corner solution 105 x 105 cm</p>	<p><b>UPW 135 85</b></p> <p><b>Not available for:</b> MIAMI, VIVA</p> <p><b>Important!</b> Planning dimensions 25.9 x 25.9 cm</p> 			91	91	109	121	121	121	135	149	-	
 <p><b>Base unit corner filler 90° for height offset</b> 9.5 x 9.5 cm</p> <p>with connection height 78 cm with connection height 71.5 cm</p> <p><i>Ill. left</i></p>	<p><b>Important!</b> Planning dimensions 65 x 65 cm</p> <p><b>Not available for:</b> ALU TEC RP, MIAMI, VIVA</p> <p><b>UPH 65 85 78</b></p> <p><b>UPH 65 85 72</b></p>	R/L		123	123	135	147	147	147	163	179	-	
		R/L		123	123	135	147	147	147	163	179	-	

## Back cladding 84.5 cm high with screw-fitted fronts

<p>841</p>  <p><b>Back cladding</b> for base units, 84.5 cm high Carcase material With screw-fitted fronts 84.1 cm only available in grid sizes</p>	<p><b>Important!</b> Observe worktop excess depth 66 cm! The plinth panel required is supplied loose.</p> <p>per 10 cm Width</p> <p><b>UVF 85</b></p>			40	42	46	66	68	71	77	85	-
<p>841</p>  <p><b>Back cladding</b> for base units, 84.5 cm high carcase material extends down to floor level With screw-fitted fronts 84.1 cm Only available in grid sizes</p>	<p><b>Important!</b> Observe worktop excess depth 66 cm! The plinth panel required is supplied loose.</p> <p>per 10 cm Width</p> <p><b>UVF 00 85</b></p>			40	42	46	66	68	71	77	85	-

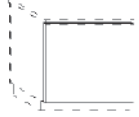

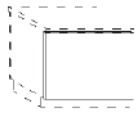

## Support panel 84.5 cm high

		Decor groups											
		Order no.	Hinge side:	Carcase depth	M10	M20	M30	M40	M50	M60	M70	M80	M90
		W H D											
 <p><b>Base unit support panel</b> 60 cm deep, 104.5 cm high without plinth cutout Height to be adapted on site</p>	<p><b>USW 105 60</b></p>			47	153	294	391	391	391	391	391	391	-
 <p><b>Base unit support panel</b> 90 cm deep, 104.5 cm high without plinth cutout Height to be adapted on site</p>	<p><b>USW 105 90</b></p>			49	180	325	435	435	435	435	435	435	-
<p><b>Central partition, separate</b> for 84.5 cm high base unit</p>		<p><b>UM 85</b></p>			40								
<p><b>Central partition installed</b> for 84.5 cm high base unit</p>		<p><b>UM 85E</b></p>			40								
<p><b>M 10</b> K M10 laminate</p>	<p><b>M 20</b> D M20 Laminate decor</p>	<p><b>M 30</b> I M30 RESOPAL PRO super matt IH M30 HPL PRO PW M30 PRIMEWOOD/Basic Veneer</p>			<p><b>M 40</b> A M40 DIRECTLACK matt L M40 DIRECTLACK high-gloss</p>		<p><b>M 50</b> B M50 Velvet lacquer S M50 microstructure lacquer</p>						
<p><b>M 60</b> QH M60 SMARTGLAS high-gloss QM M60 SMARTGLAS satin-finish</p>	<p><b>M 70</b> F M70 veneer / oak / walnut Z M70 Veneer / Bavaria</p>	<p><b>M 80</b> C1 M80 FENIX stainless-steel look H M80 high gloss-Lacquer MP M80 laqué mat Premium</p>			<p><b>M 90</b></p>								

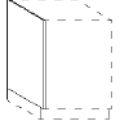

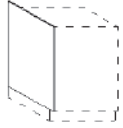

# Back cladding 84.5 cm high

Hinge side:	Carcase depth	Decor groups								
		M10	M20	M30	M40	M50	M60	M70	M80	M90

Order no.  
W H D

 <p><b>Back cladding</b> With suspension fittings for base units, 84.5 cm high 16 mm thick</p>		 <b>Important!</b> Observe worktop excess depth 64 cm! The plinth panel required is supplied loose.									
			per 10 cm Width <b>UVK 85</b>	9,30	16,20	39	52	52	52	52	52
 <p><b>Back cladding</b> With suspension fittings For base units 16 mm thick variable height</p>		 <b>Important!</b> Observe worktop excess depth 64 cm! The plinth panel required is supplied loose.									
			per m <sup>2</sup> , W x H <b>UVK 00</b> <b>minimum price</b>	118 47	200 50	483 73	644 134	644 74	644 134	644 121	644 134
<b>M 10</b> K M10 laminate	<b>M 20</b> D M20 Laminate decor	<b>M 30</b> I M30 RESOPAL PRO super matt IH M30 HPL PRO PW M30 PRIMEWOOD/Basic Veneer	<b>M 40</b> A M40 DIRECTLACK matt L M40 DIRECTLACK high-gloss		<b>M 50</b> B M50 Velvet lacquer S M50 microstructure lacquer						
<b>M 60</b> QH M60 SMARTGLAS high-gloss QM M60 SMARTGLAS satin-finish	<b>M 70</b> F M70 veneer / oak / walnut Z M70 Veneer / Bavaria	<b>M 80</b> C1 M80 FENIX stainless-steel look H M80 high gloss-Lacquer MP M80 laqué mat Premium	<b>M 90</b>								

## Visible sides / increased side depth 84.5 cm high

 <p><b>Base unit visible side</b></p> <p>55.5 cm side depth Fixed dimension, not variable 57.5 cm side depth Fixed dimension, not variable 60.5 cm side depth Fixed dimension, not variable 61 cm side depth Fixed dimension, not variable 70.5 cm side depth Fixed dimension, not variable</p>		 <b>Important!</b> Installation instead of a normal unit side. Only available in the listed side depths. For other dimensions, use USVT...											
			<b>USV 85</b>	R/L	0	0	69	69	91	91	116	145	-
			<b>USV 85 5</b>	R/L	0	0	69	69	91	91	116	145	-
			<b>USV 85 6</b>	R/L	0	0	69	69	91	91	116	145	-
			<b>USV 85 6 1</b>	R/L	0	0	69	69	91	91	116	145	-
			<b>USV 85 7</b>	R/L	0	0	69	69	91	91	116	145	-
 <p><b>Base unit increased side depth</b></p> <p>from 61.1 cm up to 90 cm side depth Up to 60.9 cm side depth</p>		 <b>Important!</b> Installation instead of a normal unit side.											
			<b>USVT 85</b>	R/L	75	75	153	153	202	202	251	288	-
			<b>USVT 85 6</b>	R/L	38	38	100	100	134	134	166	212	-
<b>M 10</b> K M10 laminate	<b>M 20</b> D M20 Laminate decor	<b>M 30</b> I M30 RESOPAL PRO super matt IH M30 HPL PRO PW M30 PRIMEWOOD/Basic Veneer	<b>M 40</b> A M40 DIRECTLACK matt L M40 DIRECTLACK high-gloss		<b>M 50</b> B M50 Velvet lacquer P M50 Soft lacquer RH M50 Velvet lacquer wood texture RW M50 Velvet lacquer spackle effect S M50 microstructure lacquer								
<b>M 60</b> QH M60 SMARTGLAS high-gloss QM M60 SMARTGLAS satin-finish	<b>M 70</b> F M70 veneer / oak / walnut V M70 Velvet lacquer textured Z M70 Veneer / Bavaria	<b>M 80</b> C1 M80 FENIX stainless-steel look H M80 high gloss-Lacquer MP M80 laqué mat Premium O M80 Veneered	<b>M 90</b>										



# Base units 84.5 cm high PREMIUMLINE

# 3.6

## PREMIUM LINE

## LINE E

Base units 26 cm high	XL 3.6.2
Base units 32,5 cm high	XL 3.6.2
Base units 52 cm high	XL 3.6.2
Base units 84.5 cm high	XL 3.6.2-XL 3.6.3
Hob base units 84.5 cm high	XL 3.6.3
Hob base units 84.5 cm high for hob extractors	XL 3.6.4
Sink carcases 84.5 cm high	XL 3.6.4
Fronts for electrical appliances	XL 3.6.5
Corner base units 84.5 cm high Le Mans	XL 3.6.5
Base units 32,5 cm high	XL 3.6.5
Base units 52 cm high	XL 3.6.5
Base units 84.5 cm high	XL 3.6.6
Corner filler 84.5 cm high	XL 3.6.7
Back cladding 84.5 cm high with screw-fitted fronts	XL 3.6.7
Background filler 84.5 cm high	XL 3.6.7
Support panel 84.5 cm high	XL 3.6.7
Back cladding 84.5 cm high	XL 3.6.8
Visible sides / increased side depth 84.5 cm high	XL 3.6.8

### Legend:



Available with grip ledge N...



Not available with grip ledge N...



This symbol indicates which models are available



This symbol indicates which models are not available



wall-mounted units



available depths for wall-mounted units



Planning advice



Merchandise net



Not available with „push-to-open“ fitting



Available carcass depths 34/45.5/55.5/61.0 cm



Available carcass depths 45.5/55.5/61.0 cm



Available carcass depths 55.5/61.0 cm

Height 84.5 cm  
PREMIUMLINE

# The most important base unit models 84.5 cm high

Page XL 3.6.2	Page XL 3.6.2	Page XL 3.6.2	Page XL 3.6.2	Page XL 3.6.2	Page XL 3.6.2	Page XL 3.6.3	Page XL 3.6.3	Page XL 3.6.3
PU..265501 Unit widths: 30/40/45/50/60 80/90/100/120	PU..325501 Unit widths: 30/40/45/50/60 70/80/90/100/120	PU..3255011 Unit widths: 30/40/45/50/60 70/80/90/100/120	PU..5255011 Unit widths: 30/40/45/50/60	PU..855560 Unit widths: 30/40/45/50/60	PU..8555902 Unit widths: 30/40/45/50/60 70/80/90/100	PU..8555922 Unit widths: 30/40/45/50/60 70/80/90/100	PU..8555921 Unit widths: 30/40/45/50/60 70/80/90/100	PU..8555901 Unit widths: 80/90/100/120
Page XL 3.6.3	Page XL 3.6.3	Page XL 3.6.3	Page XL 3.6.3	Page XL 3.6.4	Page XL 3.6.4	Page XL 3.6.4	Page XL 3.6.4	Page XL 3.6.4
PU..855590 Unit widths: 30/40/45/50/60	PU..855590 Unit widths: 80/90/100/120	PU..855560 Unit widths: 80/90/100/120	PUKI..8555911 Unit widths: 60/80/90/100	PUDK..8555911 Unit widths: 60/80/90/100	PUDK..8555028 Unit widths: 70/80/90/100/120	PUS..8555701 Unit widths: 40/45/50/60	PUS..8555701 Unit widths: 80/90/100/120	PUS..8555827 Unit widths: 60/80/90/100
Page XL 3.6.4	Page XL 3.6.4	Page XL 3.6.4	Page XL 3.6.5	Page XL 3.6.5	Page XL 3.6.5	Page XL 3.6.5	Page XL 3.6.5	Page XL 3.6.6
PUS..8555826 Unit widths: 60/70/80/90/100	PUS..8555702 Unit widths: 40/45/50/60	PUS..8555702 Unit widths: 80/90/100/120	PUTV..85 Unit widths: 45/60	PUE..856164 Unit widths: 110/115/125	PU..327001 Unit widths: 30/40/45/50/60 70/80/90/100/120	PU..3270011 Unit widths: 30/40/45/50/60 70/80/90/100/120	PU..5270011 Unit widths: 30/40/45/50/60	PU..857090 Unit widths: 30/40/45/50/60
Page XL 3.6.6	Page XL 3.6.6	Page XL 3.6.6	Page XL 3.6.6	Page XL 3.6.6	Page XL 3.6.6	Page XL 3.6.6	Page XL 3.6.6	Page XL 3.6.6
PU..8570902 Unit widths: 30/40/45/50/60	PU..8570922 Unit widths: 30/40/45/50/60	PU..8570921 Unit widths: 30/40/45/50/60	PU..8570901 Unit widths: 30/40/45/50/760	PU..8570901 Unit widths: 80/90/100/120	PU..857060 Unit widths: 30/40/45/50/60	PU..857060 Unit widths: 80/90/100/120	PU..857090 Unit widths: 80/90/100/120	PUPT..85 Unit widths: 3,5-10
Page XL 3.6.7	Page XL 3.6.7							
PUPWT..85 Unit widths: 65x65/75x75	UVF85 Unit widths:							



## Base units 26 cm high

Carcase depth 55.5 cm (standard)

■ = Models also available in 34/45.5/61 cm carcass depth (Order no.: ... replace ... 55 ... with 34/45/61)  
 □ = Models also available in 45.5/61 cm carcass depth (order no.: replace ... 55 ... with 45/61)

## PREMIUM LINE

Order no.  
W H D

Hinge side:	Carcass depth	Price groups								
		1	2	3	4	5	6	7	8	9
■	252	255	280	314	314	325	357	393	-	
	252	255	280	314	314	325	357	393	-	
	252	255	280	314	314	325	357	393	-	
	252	255	280	314	314	325	357	393	-	
	269	275	302	341	341	360	391	430	-	
	431	440	488	540	547	576	633	696	-	
	431	440	488	540	547	576	633	696	-	
	431	440	488	540	547	576	633	696	-	
	441	448	500	552	560	594	651	716	-	
■	448	462	516	566	576	610	668	735	-	

256	Base unit	1 pull-out 25.6 cm
■	PU 30 26 55 01	
■	PU 40 26 55 01	
■	PU 45 26 55 01	
■	PU 50 26 55 01	
■	PU 60 26 55 01	
■	PU 70 26 55 01	
■	PU 80 26 55 01	
■	PU 90 26 55 01	
■	PU 100 26 55 01	
■	PU 120 26 55 01	

## Base units 32,5 cm high

Carcass depth 55.5 cm (standard)

■ = Models also available in 34/45.5/61 cm carcass depth (Order no.: ... replace ... 55 ... with 34/45/61) □ = Models also available in 45.5/61 cm carcass depth (order no.: replace ... 55 ... with 45/61)

321	Base unit	1 pull-out 32.1 cm
■	PU 30 32 55 01	
■	PU 40 32 55 01	
■	PU 45 32 55 01	
■	PU 50 32 55 01	
■	PU 60 32 55 01	
■	PU 70 32 55 01	
■	PU 80 32 55 01	
■	PU 90 32 55 01	
■	PU 100 32 55 01	
■	PU 120 32 55 01	

■	260	263	288	323	323	335	368	405	-
■	260	263	288	323	323	335	368	405	-
■	260	263	288	323	323	335	368	405	-
■	260	263	288	323	323	335	368	405	-
■	278	283	312	352	352	371	403	443	-
■	444	453	502	555	563	593	652	717	-
■	444	453	502	555	563	593	652	717	-
■	444	453	502	555	563	593	652	717	-
■	454	462	515	569	577	612	670	737	-
■	462	476	532	583	593	628	688	757	-

321	Base unit	1 drawer 32.1 cm	1 internal drawer
■	PU 30 32 55 011		
■	PU 40 32 55 011		
■	PU 45 32 55 011		
■	PU 50 32 55 011		
■	PU 60 32 55 011		
■	PU 70 32 55 011		
■	PU 80 32 55 011		
■	PU 90 32 55 011		
■	PU 100 32 55 011		
■	PU 120 32 55 011		

■	345	354	383	411	418	429	457	503	-
■	345	354	383	411	418	429	457	503	-
■	345	354	383	411	418	429	457	503	-
■	345	354	383	411	418	429	457	503	-
■	363	373	405	440	446	464	492	541	-
■	534	545	594	648	654	683	744	818	-
■	534	545	594	648	654	683	744	818	-
■	534	545	594	648	654	683	744	818	-
■	545	553	606	660	668	700	763	839	-
■	552	568	623	675	685	718	780	858	-

## Base units 52 cm high

Carcass depth 55.5 cm (standard)

■ = Models also available in 34/45.5/61 cm carcass depth (Order no.: ... replace ... 55 ... with 34/45/61) □ = Models also available in 45.5/61 cm carcass depth (order no.: replace ... 55 ... with 45/61)

516	Base unit	1 pull-out 51.6 cm	1 internal pull-out
■	PU 30 52 55 011		
■	PU 40 52 55 011		
■	PU 45 52 55 011		
■	PU 50 52 55 011		
■	PU 60 52 55 011		
□	PU 70 52 55 011		
□	PU 80 52 55 011		
□	PU 90 52 55 011		
□	PU 100 52 55 011		

■	426	436	485	536	536	559	597	657	-
■	426	436	485	536	536	559	597	657	-
■	426	436	485	536	536	559	597	657	-
■	426	436	485	536	536	559	597	657	-
■	461	471	517	582	582	615	666	733	-
□	736	749	834	917	932	983	1080	1188	-
□	736	749	834	917	932	983	1080	1188	-
□	736	749	834	917	932	983	1080	1188	-
□	756	772	856	943	956	1012	1110	1221	-

## Base units 84.5 cm high

Carcass depth 55.5 cm (standard)

■ = Models also available in 34/45.5/61 cm carcass depth (Order no.: ... replace ... 55 ... with 34/45/61) □ = Models also available in 45.5/61 cm carcass depth (order no.: replace ... 55 ... with 45/61)

321 516	Base unit	1 panel 32.1 cm attached to 1 door 51.6 cm	2 adjustable shelves
■	PU 30 85 55 60	R/L	
■	PU 40 85 55 60	R/L	
■	PU 45 85 55 60	R/L	
■	PU 50 85 55 60	R/L	
■	PU 60 85 55 60	R/L	

■	188	196	222	272	294	307	339	373	-
■	188	196	222	280	294	313	342	376	-
■	188	196	222	280	294	313	342	376	-
■	188	196	222	280	313	335	374	411	-
■	223	233	253	319	365	390	431	474	-

321 516	Base unit	1 pull-out 32.1 cm	1 pull-out 51.6 cm
■	PU 30 85 55 902		
■	PU 40 85 55 902		
■	PU 45 85 55 902		
■	PU 50 85 55 902		
■	PU 60 85 55 902		
□	PU 70 85 55 902		
□	PU 80 85 55 902		
□	PU 90 85 55 902		
□	PU 100 85 55 902		

■	448	458	507	562	562	585	639	703	-
■	448	458	507	562	562	585	639	703	-
■	448	458	507	562	562	585	639	703	-
■	448	458	507	562	562	585	639	703	-
■	481	495	540	615	615	642	701	771	-
□	770	788	876	962	978	1032	1134	1247	-
□	770	788	876	965	978	1035	1134	1247	-
□	770	788	876	965	978	1035	1134	1247	-
□	791	807	898	990	1006	1060	1167	1284	-

## Base units 84.5 cm high

Carcase depth 55.5 cm (standard)

## PREMIUM LINE

### Price groups

■ = Models also available in 34/45.5/61 cm carcass depth (Order no.: ... replace ... 55 ... with 34/45/61)  
 □ = Models also available in 45.5/61 cm carcass depth (order no.: replace ... 55 ... with 45/61)

Order no.  
W H D

Hinge side:	Carcass depth	Price groups								
		1	2	3	4	5	6	7	8	9

321 516		<b>Base unit</b> 1 drawer 32.1 cm 1 internal drawer 1 pull-out 51.6 cm 1 internal pull-out	34.0 45.5 55.5 61.0	PU 30 85 55 922		■	754	765	817	867	873	893	940	1034	-
				PU 40 85 55 922		■	760	772	826	873	879	902	949	1044	-
				PU 45 85 55 922		■	761	773	827	875	880	903	950	1045	-
				PU 50 85 55 922		■	762	774	830	876	881	905	951	1046	-
				PU 60 85 55 922		■	810	828	876	940	947	976	1026	1129	-
				PU 70 85 55 922		□	1260	1276	1358	1436	1453	1502	1604	1764	-
				PU 80 85 55 922		□	1260	1276	1358	1436	1453	1502	1604	1764	-
				PU 90 85 55 922		□	1260	1276	1358	1436	1453	1502	1604	1764	-
				PU 100 85 55 922		□	1285	1307	1393	1478	1492	1545	1653	1818	-
321 516		<b>Base unit</b> 1 pull-out 32.1 cm 1 pull-out 51.6 cm 1 internal pull-out	34.0 45.5 55.5 61.0	PU 30 85 55 921		■	613	620	669	723	723	743	797	877	-
				PU 40 85 55 921		■	619	626	676	729	729	754	806	887	-
				PU 45 85 55 921		■	620	628	677	730	730	755	807	888	-
				PU 50 85 55 921		■	621	629	682	731	731	757	808	889	-
				PU 60 85 55 921		■	669	683	726	796	796	828	883	971	-
				PU 70 85 55 921		□	1079	1094	1176	1256	1271	1322	1421	1563	-
				PU 80 85 55 921		□	1079	1094	1176	1256	1271	1322	1421	1563	-
				PU 90 85 55 921		□	1079	1094	1176	1256	1271	1322	1421	1563	-
				PU 100 85 55 921		□	1103	1125	1212	1295	1310	1366	1470	1617	-
321 516		<b>Base unit</b> 1 drawer 32.1 cm 1 internal drawer 1 door 51.6 cm 1 adjustable shelf	34.0 45.5 55.5 61.0	PU 30 85 55 901	R/L	■	376	399	437	501	532	555	585	644	-
				PU 40 85 55 901	R/L	■	376	399	437	502	532	558	589	648	-
				PU 45 85 55 901	R/L	■	376	399	437	502	548	568	599	659	-
				PU 50 85 55 901	R/L	■	376	399	437	502	548	570	603	663	-
				PU 60 85 55 901	R/L	■	409	434	479	548	595	623	666	733	-
321 516		<b>Base unit</b> 1 drawer 32.1 cm 1 internal drawer 2 doors 51.6 cm 1 adjustable shelf	34.0 45.5 55.5 61.0	PU 80 85 55 901		■	495	530	565	719	805	828	909	1000	-
				PU 90 85 55 901		■	495	530	565	719	805	828	909	1000	-
				PU 100 85 55 901		■	502	542	576	735	816	841	929	1022	-
				PU 120 85 55 901		■	513	552	586	747	830	854	943	1037	-
				Width 80, 100 Not available for: GENT, INTARSIA, OSLO 15, TESSIN 15, TIM 15, VILLAGE 15-B, VILLAGE 15-S Width 90, 120 Not available for: INTARSIA											
321 516		<b>Base unit</b> 1 pull-out 32.1 cm 1 door 51.6 cm 1 adjustable shelf	34.0 45.5 55.5 61.0	PU 30 85 55 90	R/L	■	290	307	342	411	437	462	497	547	-
				PU 40 85 55 90	R/L	■	290	307	342	412	437	464	501	551	-
				PU 45 85 55 90	R/L	■	290	307	342	412	453	474	511	562	-
				PU 50 85 55 90	R/L	■	290	307	342	412	453	476	515	567	-
				PU 60 85 55 90	R/L	■	324	342	386	459	500	530	578	636	-
321 516		<b>Base unit</b> 1 pull-out 32.1 cm 2 doors 51.6 cm 1 adjustable shelf	34.0 45.5 55.5 61.0	PU 80 85 55 90		■	404	438	473	626	713	738	816	898	-
				PU 90 85 55 90		■	404	438	473	626	713	738	816	898	-
				PU 100 85 55 90		■	411	449	483	643	725	753	835	919	-
				PU 120 85 55 90		■	423	461	495	656	738	765	850	935	-
				Width 80, 100 Not available for: GENT, INTARSIA, OSLO 15, TESSIN 15, TIM 15, VILLAGE 15-B, VILLAGE 15-S Width 90, 120 Not available for: INTARSIA											
321 516		<b>Base unit</b> 2 panels 32.1 cm attached to 2 doors 51.6 cm 2 adjustable shelves	34.0 45.5 55.5 61.0	PU 80 85 55 60		■	251	261	292	420	505	548	617	679	-
				PU 90 85 55 60		■	251	261	292	420	505	548	618	680	-
				PU 100 85 55 60		■	263	276	308	443	505	548	619	681	-
				PU 120 85 55 60		■	303	322	370	524	598	647	729	802	-
				Width 80, 100 Not available for: GENT, INTARSIA, OSLO 15, TESSIN 15, TIM 15, VILLAGE 15-B, VILLAGE 15-S Width 90, 120											

## Hob base units 84.5 cm high

Carcass depth 55.5 cm (standard)

Please follow the fitting instructions from the appliance manufacturers. ▲ = Types also available with 61 cm carcass depth (order no.: ... replace ... 55 ... with 61)

321 516		<b>Hob base unit for induction hobs</b> 1 drawer 32.1 cm 1 heat shield 1 pull-out 51.6 cm	34.0 45.5 55.5 61.0	PUKI 60 85 55 911		▲	618	628	676	743	743	776	832	915	-
				PUKI 80 85 55 911		▲	936	951	1039	1121	1137	1188	1293	1422	-
				PUKI 90 85 55 911		▲	942	956	1044	1127	1145	1195	1299	1429	-
				PUKI 100 85 55 911		▲	985	1006	1097	1181	119	1256	1362	1498	-

Note:  
Cutlery organisers are not available for this article.

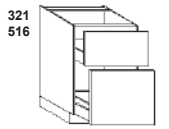
# Hob base units 84.5 cm high for hob extractors

Carcase depth 55.5 cm (standard)

Please follow the fitting instructions from the appliance manufacturers. ▲ = Types also available with 61 cm carcass depth (order no. ... replace ... 55 ... with 61)

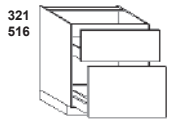
Order no.  
W H D

Hinge side:	Carcass depth	Price groups								
		1	2	3	4	5	6	7	8	9
▲	▲	770	788	876	962	978	1032	1134	1247	-
▲	▲	770	788	876	962	978	1032	1134	1247	-
▲	▲	791	807	898	990	1006	1060	1167	1284	-
▲	▲	807	828	921	1015	1032	1093	1198	1318	-
<p>Note: The pull-outs are adapted to the respective hob extractor type. We will not assume any liability for damage caused by moisture.</p>										
▲	▲	886	904	992	1078	1094	1148	1250	1375	-
▲	▲	886	904	992	1078	1094	1148	1250	1375	-
▲	▲	886	904	992	1078	1094	1148	1250	1375	-
▲	▲	907	923	1014	1106	1122	1176	1283	1411	-
<p>Note: The pull-outs are adapted to the respective hob extractor type. We will not assume any liability for damage caused by moisture.</p>										



**Hob base unit for hob extractor**  
1 fixed inside panel  
1 drawer 32.1 cm  
1 pull-out 51.6 cm

PUDK 60 85 55 911	▲	770	788	876	962	978	1032	1134	1247	-
PUDK 80 85 55 911	▲	770	788	876	962	978	1032	1134	1247	-
PUDK 90 85 55 911	▲	791	807	898	990	1006	1060	1167	1284	-
PUDK100 85 55 911	▲	807	828	921	1015	1032	1093	1198	1318	-



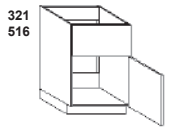
**Hob base unit for hob extractor**  
1 fixed inside panel  
1 pull-out 32.1 cm  
with wooden rear panel  
1 pull-out 51.6 cm  
with wooden rear panel

PUDK 70 85 55 028	▲	886	904	992	1078	1094	1148	1250	1375	-
PUDK 80 85 55 028	▲	886	904	992	1078	1094	1148	1250	1375	-
PUDK 90 85 55 028	▲	886	904	992	1078	1094	1148	1250	1375	-
PUDK100 85 55 028	▲	907	923	1014	1106	1122	1176	1283	1411	-

## Sink carcasses 84.5 cm high

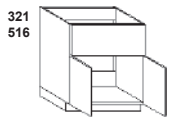
Carcass depth 55.5 cm (standard)

□ = Models also available in 45.5/61 cm carcass depth (order no.: replace ... 55 ... with 45/61) ▲ = Types also available with 61 cm carcass depth (order no.: replace ... 55 ... with 61)



**Sink carcass**  
1 panel 32.1 cm  
1 door 51.6 cm  
1 aluminium protective shelf

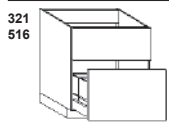
PUS 40 85 55 701	R/L ▲	211	222	239	300	335	357	389	428	-
PUS 45 85 55 701	R/L ▲	213	223	237	301	336	359	390	429	-
PUS 50 85 55 701	R/L ▲	214	224	243	302	338	368	401	441	-
PUS 60 85 55 701	R/L ▲	244	260	279	348	385	409	449	494	-



**Sink carcass**  
1 full-width panel 32.1 cm  
2 doors 51.6 cm  
1 aluminium protective shelf  
Left door with buffer strip  
Without centre panel

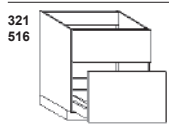
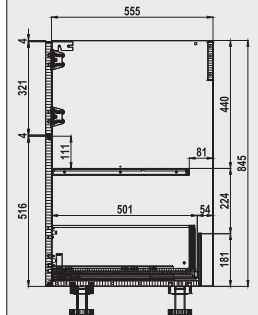
PUS 80 85 55 701	▲	279	297	324	461	534	573	641	705	-
PUS 90 85 55 701	▲	283	299	329	463	536	576	644	708	-
PUS 100 85 55 701	▲	300	312	345	494	538	578	648	713	-
PUS 120 85 55 701	▲	341	367	409	569	620	666	753	828	-

Width 80, 100 Not available for: GENT, INTARSIA, OSLO 15, TESSIN 15, TIM 15, VILLAGE 15-B, VILLAGE 15-S  
Width 90, 120



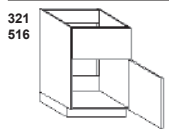
**Sink carcass**  
1 panel 32.1 cm  
1 pull-out 51.6 cm  
1 waste system in bottom pull-out

PUS 60 85 55 827	▲	680	694	733	796	812	836	874	962	-
PUS 80 85 55 827	□	1082	1091	1127	1158	1178	1229	1278	1406	-
PUS 90 85 55 827	□	1082	1091	1127	1158	1178	1229	1278	1406	-
PUS 100 85 55 827	□	1118	1128	1166	1203	1225	1279	1332	1465	-



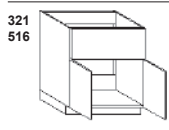
**Sink carcass**  
1 panel 32.1 cm  
1 pull-out 51.6 cm

PUS 60 85 55 826	▲	409	434	479	548	595	623	666	733	-
PUS 70 85 55 826	▲	711	720	755	795	816	865	914	1005	-
PUS 80 85 55 826	▲	711	720	755	795	816	865	914	1005	-
PUS 90 85 55 826	▲	711	720	755	795	816	865	914	1005	-
PUS 100 85 55 826	▲	739	748	787	832	854	909	960	1056	-



**Sink carcass**  
1 panel 32.1 cm  
1 door 51.6 cm  
without aluminium protective shelf

PUS 40 85 55 702	R/L □	187	196	217	277	313	333	371	408	-
PUS 45 85 55 702	R/L □	187	196	217	277	313	333	371	408	-
PUS 50 85 55 702	R/L □	187	196	217	277	313	339	375	413	-
PUS 60 85 55 702	R/L □	217	230	253	322	359	379	423	465	-



**Sink carcass**  
1 full-width panel 32.1 cm  
2 doors 51.6 cm  
without aluminium protective shelf  
Left door with buffer strip  
Without centre panel

PUS 80 85 55 702	□	243	259	285	425	496	537	603	663	-
PUS 90 85 55 702	□	243	259	285	425	496	537	605	666	-
PUS 100 85 55 702	□	258	268	303	449	496	537	606	667	-
PUS 120 85 55 702	□	298	319	359	520	573	621	705	776	-

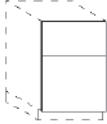
Width 80, 100 Not available for: GENT, INTARSIA, OSLO 15, TESSIN 15, TIM 15, VILLAGE 15-B, VILLAGE 15-S  
Width 90, 120

# Fronts for electrical appliances

		Price groups								
Hinge side:	Carcase depth	1	2	3	4	5	6	7	8	9

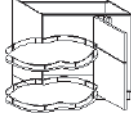
Please specify the dishwasher item number when ordering.

Order no.  
W H D

<p>321 516</p>  <p><b>Base unit door, 84.1 cm</b> 1 panel 32.1 cm attached to 1 door 51.6 cm</p> <p>As front panel for fully integrated dishwashers 86 cm high and pull-out fridges and freezers</p> <p><i>Surcharge in connection with the grip rails N700 and N775 incl. connecting plate and additional grip rails</i></p> <p><i>Surcharge in connection with the grip rails N700 and N775 incl. connecting plate and additional grip rails</i></p>										

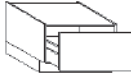
## Corner base units 84.5 cm high Le Mans

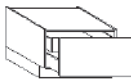
Carcase depth 55.5 cm (standard)  
▲ = Types also available with 61 cm carcase depth (order no. ... replace ... 55 ... with 61)

<p>321 516</p>  <p><b>Corner base unit „Le Mans“</b> Blind section left or right 1 panel 32.1 cm attached to 1 door 51.6 cm</p> <p>2 wooden carousel shelves with chrome-plated rail fully swivelling „Le Mans“ Carcase width 100 cm with loose corner filler</p> <p>Door 45 cm Door 50 cm Door 60 cm</p> <p><b>Extra charge for extending corner filler width</b></p>										

## Base units 32,5 cm high

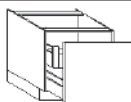
Carcase depth 70.5 cm

<p>321</p>  <p><b>Base unit</b> 1 pull-out 32.1 cm Carcase depth 70.5 cm</p>										

<p>321</p>  <p><b>Base unit</b> 1 drawer 32.1 cm 1 internal drawer Carcase depth 70.5 cm</p>										

## Base units 52 cm high

Carcase depth 70.5 cm




<p>516</p>  <p><b>Base unit</b> 1 pull-out 51.6 cm 1 internal pull-out Carcase depth 70.5 cm</p>										

## Base units 84.5 cm high

Carcase depth 70.5 cm

## PREMIUM LINE

Order no.  
W H D

Hinge side:	Carcase depth	Price groups																
		1	2	3	4	5	6	7	8	9								
R/L	70.5	321 516	Base unit	1 pull-out 32.1 cm	1 door 51.6 cm	1 adjustable shelf	Carcase depth 70.5 cm	PU 30 85 70 90	463	480	516	585	611	635	669	736	-	
		PU 40 85 70 90	463	480	516	586	611	638	674	741	-							
		PU 45 85 70 90	463	480	516	586	625	647	685	754	-							
		PU 50 85 70 90	463	480	516	586	625	649	688	757	-							
		PU 60 85 70 90	497	516	558	631	672	702	750	825	-							
R/L	70.5	321 516	Base unit	1 pull-out 32.1 cm	1 pull-out 51.6 cm	Carcase depth 70.5 cm	PU 30 85 70 902	633	641	694	738	738	760	811	892	-		
		PU 40 85 70 902	633	641	694	738	738	760	811	892	-							
		PU 45 85 70 902	633	641	694	738	738	760	811	892	-							
		PU 50 85 70 902	633	641	694	738	738	760	811	892	-							
		PU 60 85 70 902	663	672	722	789	789	816	876	964	-							
R/L	70.5	321 516	Base unit	1 drawer 32.1 cm	1 internal drawer	1 pull-out 51.6 cm	1 internal pull-out	Carcase depth 70.5 cm	PU 30 85 70 922	1123	1133	1182	1225	1225	1248	1296	1426	-
		PU 40 85 70 922	1123	1133	1182	1225	1225	1248	1296	1426	-							
		PU 45 85 70 922	1123	1133	1182	1225	1225	1248	1296	1426	-							
		PU 50 85 70 922	1123	1133	1182	1225	1225	1248	1296	1426	-							
		PU 60 85 70 922	1154	1162	1213	1276	1276	1302	1358	1494	-							
R/L	70.5	321 516	Base unit	1 pull-out 32.1 cm	1 pull-out 51.6 cm	1 internal pull-out	Carcase depth 70.5 cm	PU 30 85 70 921	796	807	856	900	900	922	971	1068	-	
		PU 40 85 70 921	796	807	856	900	900	922	971	1068	-							
		PU 45 85 70 921	796	807	856	900	900	922	971	1068	-							
		PU 50 85 70 921	796	807	856	900	900	922	971	1068	-							
		PU 60 85 70 921	829	835	886	950	950	975	1031	1134	-							
R/L	70.5	321 516	Base unit	1 drawer 32.1 cm	1 internal drawer	1 door 51.6 cm	1 adjustable shelf	Carcase depth 70.5 cm	PU 30 85 70 901	585	606	646	710	740	764	793	872	-
		PU 40 85 70 901	585	606	646	711	740	766	797	877	-							
		PU 45 85 70 901	585	606	646	711	757	776	808	889	-							
		PU 50 85 70 901	585	606	646	711	757	778	811	892	-							
		PU 60 85 70 901	618	642	688	757	803	832	875	963	-							
R/L	70.5	321 516	Base unit	1 drawer 32.1 cm	1 internal drawer	2 doors 51.6 cm	1 adjustable shelf	Carcase depth 70.5 cm	PU 80 85 70 901	720	729	761	903	961	1003	1070	1177	-
		PU 90 85 70 901	720	729	761	903	961	1003	1070	1177	-							
		PU 100 85 70 901	728	740	772	919	975	1017	1089	1198	-							
		PU 120 85 70 901	738	753	783	932	987	1029	1102	1212	-							
		 Width 80, 100 Not available for: GENT, INTARSIA, OSLO 15, TESSIN 15, TIM 15, VILLAGE 15-B, VILLAGE 15-S Width 90, 120 Not available for: INTARSIA																
R/L	70.5	321 516	Base unit	1 panel 32.1 cm attached to 1 door 51.6 cm	2 adjustable shelves	Carcase depth 70.5 cm	PU 30 85 70 60	271	283	312	359	378	389	423	465	-		
		PU 40 85 70 60	271	283	312	367	378	396	428	471	-							
		PU 45 85 70 60	271	283	312	367	385	409	428	471	-							
		PU 50 85 70 60	271	283	312	367	396	426	463	509	-							
		PU 60 85 70 60	312	324	336	403	448	476	513	564	-							
R/L	70.5	321 516	Base unit	2 panels 32.1 cm attached to 2 doors 51.6 cm	2 adjustable shelves	Carcase depth 70.5 cm	PU 80 85 70 60	330	341	373	499	594	629	702	772	-		
		PU 90 85 70 60	330	341	373	499	594	629	702	772	-							
		PU 100 85 70 60	348	361	392	522	615	667	744	818	-							
		PU 120 85 70 60	395	421	469	620	699	743	826	909	-							
		 Width 80, 100 Not available for: GENT, INTARSIA, OSLO 15, TESSIN 15, TIM 15, VILLAGE 15-B, VILLAGE 15-S Width 90, 120																
R/L	70.5	321 516	Base unit	1 pull-out 32.1 cm	2 doors 51.6 cm	1 adjustable shelf	Carcase depth 70.5 cm	PU 80 85 70 90	507	516	548	690	749	790	858	944	-	
		PU 90 85 70 90	507	516	548	690	749	790	858	944	-							
		PU 100 85 70 90	515	527	559	706	762	803	876	964	-							
		PU 120 85 70 90	525	540	570	719	774	816	889	978	-							
		 Width 80, 100 Not available for: GENT, INTARSIA, OSLO 15, TESSIN 15, TIM 15, VILLAGE 15-B, VILLAGE 15-S Width 90, 120 Not available for: INTARSIA																

## Front filler 84.5 cm high

**Base unit front filler divided**  
 consisting of one element 32.1 cm  
 and one element 51.6 cm

3.5 - 10 cm  
 10.1 - 20 cm

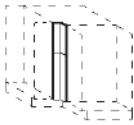


Note:  
 Not available with grip ledges

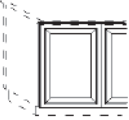
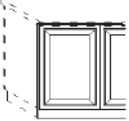
PUPT 10 85	101	101	109	143	143	143	154	169	-
PUPT 20 85	122	122	126	180	180	180	198	218	-



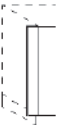

# Corner filler 84.5 cm high

		Price groups									
		1	2	3	4	5	6	7	8	9	
 <p><b>Base unit corner filler 90° partitioned by up to 20 x 20 cm</b> consisting of one element 32.1 cm and one element 51.6 cm</p> <p>9.5 x 9.5 cm up to 20 x 20 cm</p>	<p><b>Order no.</b> W H D</p>	<p><b>Important!</b> Planning dimensions 65 x 65 cm Items can only be fitted in the ALU TEC RP models with a minimum size of 6 x 6 cm. Note: Not available with grip ledges</p>									
		<b>PUPWT65 85</b>	183	183	215	231	231	231	269	296	-
		<b>PUPWT75 85</b>	201	201	223	254	254	254	331	364	-



## Back cladding 84.5 cm high with screw-fitted fronts

<p>841</p>  <p><b>Back cladding</b> for base units, 84.5 cm high Carcase material With screw-fitted fronts 84.1 cm only available in grid sizes</p>	<p>per 10 cm Width</p>	<b>UVF 85</b>	40	42	46	66	68	71	77	85	-
		<p><b>Important!</b> Observe worktop excess depth 66 cm! The plinth panel required is supplied loose.</p>									
<p>841</p>  <p><b>Back cladding</b> for base units, 84.5 cm high carcase material extends down to floor level With screw-fitted fronts 84.1 cm Only available in grid sizes</p>	<p>per 10 cm Width</p>	<b>UVF 00 85</b> <b>minimum price</b>	40	42	46	66	68	71	77	85	-
		<p><b>Important!</b> Observe worktop excess depth 66 cm! The plinth panel required is supplied loose.</p>									

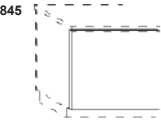

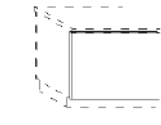

## Background filler 84.5 cm high

		Decor groups									
		M10	M20	M30	M40	M50	M60	M70	M80	M90	
 <p><b>Base unit background filler</b> Width: 20 cm For fitting flush with carcase</p>	<p><b>Order no.</b> W H D</p>	<p>Hinge side: Carcase depth</p>	<b>UPSL0085</b>								
			27,70	29,50	52	70	70	70	70	70	70
 <p><b>Base unit corner background fillers</b> For corner solution 105 x 105 cm</p>	<p><b>Order no.</b> W H D</p>	<p>Hinge side: Carcase depth</p>	<b>UWSL 85 1</b>								
			54	54	70	93	93	93	93	93	93
		<b>M 10</b>		<b>M 20</b>		<b>M 30</b>		<b>M 40</b>		<b>M 50</b>	
K M10 laminate		D M20 Laminate decor		I M30 RESOPAL PRO super matt IH M30 HPL PRO PW M30 PRIMEWOOD/Basic Veneer		A M40 DIRECTLACK matt L M40 DIRECTLACK high-gloss		B M50 Velvet lacquer P M50 Soft lacquer S M50 microstructure lacquer			
		<b>M 60</b>		<b>M 70</b>		<b>M 80</b>		<b>M 90</b>			
QH M60 SMARTGLAS high-gloss QM M60 SMARTGLAS satin-finish		F M70 veneer / oak / walnut Z M70 Veneer / Bavaria		C1 M80 FENIX stainless-steel look H M80 high gloss-Lacquer MP M80 laqué mat Premium							

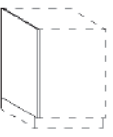



## Support panel 84.5 cm high

 <p><b>Base unit support panel</b> 60 cm deep, 104.5 cm high without plinth cutout Height to be adapted on site</p>	<p>Unit price</p>	<b>USW 105 60</b>	47	153	294	391	391	391	391	391	-
 <p><b>Base unit support panel</b> 90 cm deep, 104.5 cm high without plinth cutout Height to be adapted on site</p>	<p>Unit price</p>	<b>USW 105 90</b>	49	180	325	435	435	435	435	435	-
		<b>M 10</b>		<b>M 20</b>		<b>M 30</b>		<b>M 40</b>		<b>M 50</b>	
K M10 laminate		D M20 Laminate decor		I M30 RESOPAL PRO super matt IH M30 HPL PRO PW M30 PRIMEWOOD/Basic Veneer		A M40 DIRECTLACK matt L M40 DIRECTLACK high-gloss		B M50 Velvet lacquer S M50 microstructure lacquer			
		<b>M 60</b>		<b>M 70</b>		<b>M 80</b>		<b>M 90</b>			
QH M60 SMARTGLAS high-gloss QM M60 SMARTGLAS satin-finish		F M70 veneer / oak / walnut Z M70 Veneer / Bavaria		C1 M80 FENIX stainless-steel look H M80 high gloss-Lacquer MP M80 laqué mat Premium							

# Back cladding 84.5 cm high

		Decor groups													
		Order no.		Hinge side:	Carcass depth	M10	M20	M30	M40	M50	M60	M70	M80	M90	
		W H D													
 <p><b>Back cladding</b> With suspension fittings for base units, 84.5 cm high 16 mm thick</p>	per 10 cm Width														
	<b>UVK 85</b>					9,30	16,20	39	52	52	52	52	52	-	
		 <b>Important!</b> Observe worktop excess depth 64 cm! The plinth panel required is supplied loose.													
 <p><b>Back cladding</b> With suspension fittings For base units 16 mm thick variable height</p>	per m <sup>2</sup> , W x H														
	<b>UVK 00</b>					118	200	483	644	644	644	644	644	-	
		 <b>Important!</b> Observe worktop excess depth 64 cm! The plinth panel required is supplied loose.													
<b>M 10</b>		<b>M 20</b>		<b>M 30</b>		<b>M 40</b>		<b>M 50</b>							
K M10 laminate		D M20 Laminate decor		I M30 RESOPAL PRO super matt IH M30 HPL PRO PW M30 PRIMEWOOD/Basic Veneer		A M40 DIRECTLACK matt L M40 DIRECTLACK high-gloss		B M50 Velvet lacquer S M50 microstructure lacquer							
<b>M 60</b>		<b>M 70</b>		<b>M 80</b>		<b>M 90</b>									
QH M60 SMARTGLAS high-gloss QM M60 SMARTGLAS satin-finish		F M70 veneer / oak / walnut Z M70 Veneer / Bavaria		C1 M80 FENIX stainless-steel look H M80 high gloss-Lacquer MP M80 laqué mat Premium											

## Visible sides / increased side depth 84.5 cm high

 <p><b>Base unit visible side</b></p> <p>55.5 cm side depth Fixed dimension, not variable 57.5 cm side depth Fixed dimension, not variable 60.5 cm side depth Fixed dimension, not variable 61 cm side depth Fixed dimension, not variable 70.5 cm side depth Fixed dimension, not variable</p>			 <b>Important!</b> Installation instead of a normal unit side. Only available in the listed side depths. For other dimensions, use USVT...												
	<b>USV 85</b>	R/L				0	0	69	69	91	91	116	145	-	
	<b>USV 85 5</b>	R/L				0	0	69	69	91	91	116	145	-	
	<b>USV 85 6</b>	R/L				0	0	69	69	91	91	116	145	-	
	<b>USV 85 6 1</b>	R/L				0	0	69	69	91	91	116	145	-	
 <p><b>Base unit increased side depth</b></p> <p>from 61.1 cm up to 90 cm side depth Up to 60.9 cm side depth</p>			 <b>Important!</b> Installation instead of a normal unit side.												
	<b>USVT 85</b>	R/L				75	75	153	153	202	202	251	288	-	
	<b>USVT 85 6</b>	R/L				38	38	100	100	134	134	166	212	-	
<b>M 10</b>		<b>M 20</b>		<b>M 30</b>		<b>M 40</b>		<b>M 50</b>							
K M10 laminate		D M20 Laminate decor		I M30 RESOPAL PRO super matt IH M30 HPL PRO PW M30 PRIMEWOOD/Basic Veneer		A M40 DIRECTLACK matt L M40 DIRECTLACK high-gloss		B M50 Velvet lacquer P M50 Soft lacquer RH M50 Velvet lacquer wood texture RW M50 Velvet lacquer spackle effect S M50 microstructure lacquer							
<b>M 60</b>		<b>M 70</b>		<b>M 80</b>		<b>M 90</b>									
QH M60 SMARTGLAS high-gloss QM M60 SMARTGLAS satin-finish		F M70 veneer / oak / walnut V M70 Velvet lacquer textured Z M70 Veneer / Bavaria		C1 M80 FENIX stainless-steel look H M80 high gloss-Lacquer MP M80 laqué mat Premium O M80 Veneered											



# 3.7

## Base units 91 cm high

Base units 91 cm high with wall mounting	XL 3.7.2
Base units 91 cm high with glass fronts model-specific	XL 3.7.3
Base units 91 cm high with glass fronts neutral	XL 3.7.4
Base shelf units 91 cm high with wall mounting	XL 3.7.4
Background filler 91 cm high	XL 3.7.5
Front filler 91 cm high	XL 3.7.5
Corner filler 91 cm high	XL 3.7.5
Back cladding 91 cm high with screw-fitted fronts	XL 3.7.5
Back cladding 91 cm high	XL 3.7.6
Visible sides / increased side depth 91 cm high	XL 3.7.6

### Legend:



Available with grip ledge N...



Not available with grip ledge N...



This symbol indicates which models are available



This symbol indicates which models are not available



Planning advice



Available carcass depths 34/45.5/55.5/61.0 cm



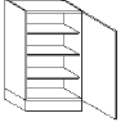
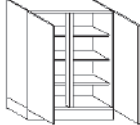

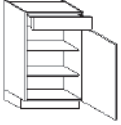


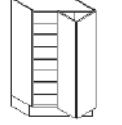
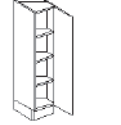
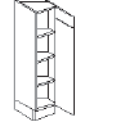

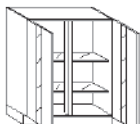

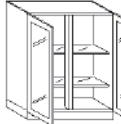



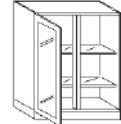
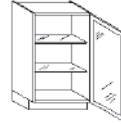
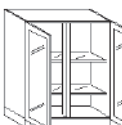

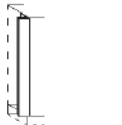
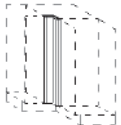
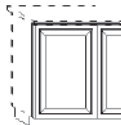
Available carcass depths 45.5/55.5/61.0 cm



Available carcass depths 55.5/61.0 cm

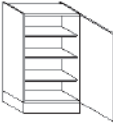

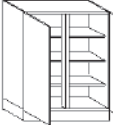
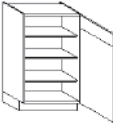
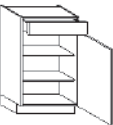





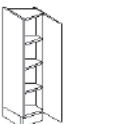


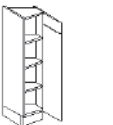




# The most important base unit models 91 cm high

Page XL 3.7.2	Page XL 3.7.2	Page XL 3.7.2	Page XL 3.7.2	Page XL 3.7.2	Page XL 3.7.2	Page XL 3.7.2	Page XL 3.7.2	Page XL 3.7.2
								
<b>U..913470</b> Unit widths: 20/25/30/40/ 45/50/60	<b>U..913470</b> Unit widths: 60 80/90/100	<b>U..913460</b> Unit widths: 30/40/45/50/60	<b>U..913410</b> Unit widths: 30/40/45/50/60 70/80/90/100/120	<b>U..913420</b> Unit widths: 30/40/45/50/60	<b>U..913450</b> Unit widths: 30/40/45/50/60	<b>UF..913475</b> Unit widths: 60	<b>US..913470</b> Unit widths: 25	<b>US..913460</b> Unit widths: 25
Page XL 3.7.3	Page XL 3.7.3	Page XL 3.7.3	Page XL 3.7.3	Page XL 3.7.3	Page XL 3.7.3	Page XL 3.7.4	Page XL 3.7.4	Page XL 3.7.4
								
<b>UG..9134LB</b> Unit widths: 45/50/60	<b>UG..9134LB</b> Unit widths: 90/100	<b>UG..9134RA</b> Unit widths: 45/50/60	<b>UG..9134RA</b> Unit widths: 90/100	<b>UG..9134LS</b> Unit widths: 45/50/60	<b>UG..9134LB</b> Unit widths: 90/100	<b>UGDA..9134</b> Unit widths: 45/50/60	<b>UGDA..9134</b> Unit widths: 90/100	<b>UGD..9134</b> Unit widths: 45/50/60
Page XL 3.7.4	Page XL 3.7.4	Page XL 3.7.5	Page XL 3.7.5	Page XL 3.7.5				
								
<b>UGD..9134</b> Unit widths: 90/100	<b>UR..9136</b> Unit widths: 30/40/45/50/60	<b>UPA..91</b> Unit widths: 10-20	<b>UPW..91</b> Unit widths:	<b>UVF91</b> Unit widths:				


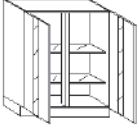

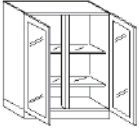

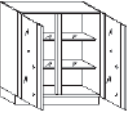
# Base units 91 cm high with wall mounting

Carcase depth 34 cm

		Order no.	W	H	D	Hinge side:	Carcase depth	Price groups								
								1	2	3	4	5	6	7	8	9
 <p><b>Base unit</b> 1 door 90.6 cm 3 adjustable shelves with wall mounting</p>		U	20	91	34	70	R/L	191	199	224	281	299	312	347	382	-
							R/L	191	199	224	281	299	312	347	382	-
							R/L	191	199	224	281	299	312	347	382	-
							R/L	191	199	224	287	299	320	352	387	-
							R/L	191	199	224	287	299	320	352	387	-
							R/L	191	199	224	287	320	341	377	415	-
							R/L	226	236	258	323	369	400	441	485	-
 <p>width 20 cm: <i>FRAME, VILLAGE 15-S, VILLAGE 15-B, CHALET-S, CHALET-B, OSLO 15, TESSIN 15, BERGEN, LUGANO, CASTELLO, VIVA, TIM 15</i> are supplied with smooth fronts. width 25 cm: <i>FRAME</i> are supplied with smooth fronts.</p>																
 <p><b>Base unit</b> 2 doors 90.6 cm 3 adjustable shelves with wall mounting</p>		U	80	91	34	70		278	294	312	431	478	506	549	604	-
								278	294	312	431	478	506	549	604	-
								307	319	340	456	501	534	573	630	-
 <p><b>Base unit</b> 1 panel 12.6 cm attached to 1 door 77.6 cm 3 adjustable shelves with wall mounting</p>		U	30	91	34	60	R/L	191	199	224	281	299	312	347	382	-
							R/L	191	199	224	287	299	320	352	387	-
							R/L	191	199	224	287	299	320	352	387	-
							R/L	191	199	224	287	320	341	377	415	-
							R/L	226	236	258	323	369	400	441	485	-
 <p><b>Base unit</b> 1 drawer 12.6 cm 1 door 77.6 cm 2 adjustable shelves with wall mounting</p>		U	30	91	34	10	R/L	239	250	275	337	360	375	411	452	-
							R/L	239	250	275	338	360	377	413	454	-
							R/L	239	250	275	338	369	391	425	468	-
							R/L	239	250	275	338	369	396	431	474	-
							R/L	268	282	315	381	414	442	485	534	-
 <p><b>Base unit</b> 2 drawers 12.6 cm 1 door 64.6 cm 2 adjustable shelves with wall mounting</p>		U	30	91	34	20	R/L	343	353	377	440	462	480	515	567	-
							R/L	343	353	377	441	462	482	517	569	-
							R/L	343	353	377	441	474	490	528	581	-
							R/L	343	353	377	441	474	496	533	586	-
							R/L	373	385	419	484	518	547	587	646	-
 <p><b>Base unit</b> 7 drawers 12.6 cm with wall mounting</p>		U	30	91	34	50		769	777	819	912	912	929	997	1097	-
								769	777	819	912	912	929	997	1097	-
								769	777	819	912	912	929	997	1097	-
								769	777	819	912	912	929	997	1097	-
								801	813	850	953	953	982	1059	1165	-
 <p><b>Base unit with folding door</b> 1 sliding-folding door, 2-part, 90.6 cm 3 adjustable shelves with wall mounting</p>		UF	60	91	34	75	R/L	308	321	340	407	448	481	524	576	-
							 <p>Important! Hinge right means drill hole for handle on left-hand side of right door.</p>									
 <p><b>Base unit angled by 37.2°</b> 25 cm wide 1 door 30 cm wide, 90.6 cm high 3 adjustable shelves 1 plinth panel, separate For adjacent fitting left or right with wall mounting</p>		US	25	91	34	70	R/L	365	372	395	446	467	480	509	560	-
							 <p>Important! Worktop length 27.5 cm</p>									
 <p><b>Base unit angled by 37.2°</b> 25 cm wide 1 panel 12.6 cm attached to 1 door 77.6 cm 30 cm wide 3 adjustable shelves 1 plinth panel, separate For adjacent fitting left or right with wall mounting</p>		US	25	91	34	60	R/L	365	372	395	446	467	480	509	560	-
							 <p>Important! Worktop length 27.5 cm</p>									



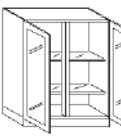


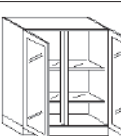
# Base units 91 cm high with glass fronts model-specific

Carcase depth 34 cm

		Order no.		Hinge side:		Price groups										
		W	H	D		Carcase depth	1	2	3	4	5	6	7	8	9	
906	 <p><b>Base unit with glass door</b> -model-specific- 1 semi-frameless glass door 90.6 cm Glass width 5 cm 2 adjustable glass shelves with wall mounting</p>				R/L		UG 45 91 34 LB	328	328	332	508	508	536	583	641	-
					R/L		UG 50 91 34 LB	332	332	343	518	518	549	596	656	-
					R/L		UG 60 91 34 LB	346	346	359	549	549	573	626	689	-
							<p><b>Available for:</b> BAVARIA, EDITION, FENIX INOX, FLORENZ, GARDA, HPL PRO, MALMÖ, MODENA, MONTANA, MUNICH, NEVADA, PADUA, PRIMEWOOD TOP, PUR, RESOPAL, RESOPAL PRO, RESOPAL PRO EDGE, RIVA, RUSTY OAK, SHERWOOD, SMART, SMART MIRROR, SMART-M, TOP, TREND</p> <p><b>available glass versions:</b> 90 = clear glass 93 = black glass 92 = matt glass 88 = Linea glass</p>									
906	 <p><b>Base unit with glass door</b> -model-specific- 2 semi-frameless glass doors 90.6 cm Glass width 5 cm 2 adjustable glass shelves with wall mounting</p>				R/L		UG 90 91 34 LB	479	479	491	681	681	703	760	836	-
					R/L		UG 100 91 34 LB	496	496	512	700	700	724	777	855	-
							<p><b>Available for:</b> BAVARIA, EDITION, FENIX INOX, FLORENZ, GARDA, HPL PRO, MALMÖ, MODENA, MONTANA, MUNICH, NEVADA, PADUA, PRIMEWOOD TOP, PUR, RESOPAL, RESOPAL PRO, RESOPAL PRO EDGE, RIVA, RUSTY OAK, SHERWOOD, SMART, SMART MIRROR, SMART-M, TOP, TREND</p> <p><b>available glass versions:</b> 90 = clear glass 93 = black glass 92 = matt glass 88 = Linea glass</p>									
906	 <p><b>Base unit with glass door</b> -model-specific- 1 glass door 90.6 cm 2 adjustable glass shelves with wall mounting</p>				R/L		UG 45 91 34 RA	297	297	302	480	480	504	552	607	-
					R/L		UG 50 91 34 RA	302	302	311	485	485	513	559	615	-
					R/L		UG 60 91 34 RA	311	311	324	516	516	541	596	656	-
							<p><b>Available for:</b> ARTE-B, ARTE-S, ATLANTA-B, ATLANTA-S, BERGEN, CASA-B, CASTELLO, CHALET-B, CHALET-S, CHICAGO, FRAME, LUGANO, LUX-B, MIAMI, NEW OPAL-M, NOBEL-B, NOBEL-S, OPAL-H, ORLANDO-B, ORLANDO-S, PALAZZO, PALERMO-B, PALERMO-S, ROMA-B, ROMA-S, SIGNUM-B, SOFIE-B, SOFIE-S, VINO, VIVA, YORK-B, YORK-S</p> <p><b>available glass versions:</b> 90 = clear glass 93 = black glass 92 = matt glass 88 = Linea glass</p>									
906	 <p><b>Base unit with glass door</b> -model-specific- 2 glass doors 90.6 cm 2 adjustable glass shelves with wall mounting</p>				R/L		UG 90 91 34 RA	446	446	460	649	649	671	727	800	-
					R/L		UG 100 91 34 RA	466	466	481	667	667	692	745	820	-
							<p><b>Available for:</b> ARTE-B, ARTE-S, ATLANTA-B, ATLANTA-S, BERGEN, CASA-B, CASTELLO, CHALET-B, CHALET-S, CHICAGO, FRAME, LUGANO, LUX-B, MIAMI, NEW OPAL-M, NOBEL-B, NOBEL-S, OPAL-H, ORLANDO-B, ORLANDO-S, PALAZZO, PALERMO-B, PALERMO-S, ROMA-B, ROMA-S, SIGNUM-B, SOFIE-B, SOFIE-S, VINO, VIVA, YORK-B, YORK-S</p> <p><b>available glass versions:</b> 90 = clear glass 93 = black glass 92 = matt glass 88 = Linea glass</p>									
906	 <p><b>Base unit with glass door</b> -model-specific- 1 semi-frameless glass door 90.6 cm 2 adjustable glass shelves with wall mounting</p>				R/L		UG 45 91 34 LS	328	328	332	508	508	536	583	641	-
					R/L		UG 50 91 34 LS	332	332	343	518	518	549	596	656	-
					R/L		UG 60 91 34 LS	346	346	359	549	549	573	626	689	-
							<p><b>Available for:</b> BAVARIA, EDITION, FENIX INOX, FLORENZ, GARDA, GENT, HPL PRO, MALMÖ, MODENA, MONTANA, MUNICH, NEVADA, OSLO 15, PADUA, PRIMEWOOD TOP, PUR, RESOPAL, RESOPAL PRO, RESOPAL PRO EDGE, RIVA, RUSTY OAK, SHERWOOD, SMART, SMART MIRROR, SMART-M, TESSIN 15, TIM, TIM 15, TOP, TREND, VILLAGE 15-B, VILLAGE 15-S</p> <p><b>available glass versions:</b> 90 = clear glass 93 = black glass 92 = matt glass 88 = Linea glass</p>									
906	 <p><b>Base unit with glass door</b> -model-specific- 2 semi-frameless glass doors 90.6 cm 2 adjustable glass shelves with wall mounting</p>				R/L		UG 90 91 34 LS	479	479	491	681	681	703	760	836	-
					R/L		UG 100 91 34 LS	496	496	512	700	700	724	777	855	-
							<p><b>Available for:</b> BAVARIA, EDITION, FENIX INOX, FLORENZ, GARDA, GENT, HPL PRO, MALMÖ, MODENA, MONTANA, MUNICH, NEVADA, OSLO 15, PADUA, PRIMEWOOD TOP, PUR, RESOPAL, RESOPAL PRO, RESOPAL PRO EDGE, RIVA, RUSTY OAK, SHERWOOD, SMART, SMART MIRROR, SMART-M, TESSIN 15, TIM, TIM 15, TOP, TREND, VILLAGE 15-B, VILLAGE 15-S</p> <p><b>available glass versions:</b> 90 = clear glass 93 = black glass 92 = matt glass 88 = Linea glass</p>									

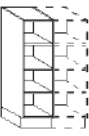
## Base units 91 cm high with glass fronts neutral

Carcase depth 34 cm


				Glass groups						
Order no. W H D				Hinge side:	Carcase depth	G1	G2	G2S	G5S	G6
 <p><b>Base unit with glass door</b> -neutral- 1 AktivGlas door 90.6 cm with „push to open“ fitting 2 adjustable glass shelves with wall mounting</p>	AKTIV GLAS	UGDA 45 91 34	R/L	402	-	-	-	-	-	
		UGDA 50 91 34	R/L	411	-	-	-	-	-	
		UGDA 60 91 34	R/L	435	-	-	-	-	-	
		 <b>Note:</b> Without drill hole for handle, knobs/handles not possible with „push to open“ fitting.								
 <p><b>Base unit with glass door</b> -neutral- 2 AktivGlas doors 90.6 cm with „push to open“ fitting 2 adjustable glass shelves with wall mounting</p>	AKTIV GLAS	UGDA 90 91 34		667	-	-	-	-	-	
		UGDA100 91 34		761	-	-	-	-	-	
		 <b>Note:</b> Without drill hole for handle, knobs/handles not possible with „push to open“ fitting.								
 <p><b>Base unit with glass front</b> -neutral- 1 glass door 90.6 cm 2 adjustable glass shelves with wall mounting</p>		UGD 45 91 34	R/L	-	519	519	603	903		
		UGD 50 91 34	R/L	-	540	540	631	924		
		UGD 60 91 34	R/L	-	594	594	700	978		
 <p><b>Base unit with glass front</b> -neutral- 2 glass doors 90.6 cm 2 adjustable glass shelves with wall mounting</p>		UGD 90 91 34		-	903	903	1021	1287		
		UGD 100 91 34		-	1019	1019	1171	1403		
<b>G1</b>		<b>G2</b>			<b>G2S</b>					
<b>G1 AKTIVglass frame</b> 991 Matt glass 992 Translucent black glass		<b>G2 Design front</b> 925 Frame White Agate/Matt glass 935 Premium W. Frame/Matt Glass 940 Macaron Col. Frame/Matt Glass 95 Light grey frame/matt glass 96 Silver Col. Frame/Matt Glass 960 Snow White Frame/Matt Glass 97 Black frame/black glass			<b>G2S aluminium, framed glass door</b> 988 aluminium black, Linea glass 994 Aluminium frame/clear glass 995 aluminium frame/black glass					
<b>G5</b>		<b>G5S</b>			<b>G6</b>					
		G5S aluminium, door with mullion 996 Alum.frame/clear gl./cross bar			<b>G6 NEW SALON</b> 986 aluminium black, black glass 987 aluminium black, clear glass 989 aluminium matt, bronze-coloured black glass 990 aluminium matt, bronze-coloured clear glass					

## Base shelf units 91 cm high with wall mounting




Carcase depth 36.1 cm

				Decor groups										
Order no. W H D				Hinge side:	Carcase depth	M10	M20	M30	M40	M50	M60	M70	M80	M90
 <p><b>Base shelf unit</b> 3 adjustable shelves with wall mounting wide in cm: 13-30 wide in cm: 30,1-40 wide in cm: 40,1-45 wide in cm: 45,1-50 wide in cm: 50,1-60</p>		UR 30 91 36		216	-	-	-	718	-	718	718	-		
		UR 40 91 36		216	-	-	-	718	-	718	718	-		
		UR 45 91 36		216	-	-	-	718	-	718	718	-		
		UR 50 91 36		216	-	-	-	718	-	718	718	-		
		UR 60 91 36		216	-	-	-	718	-	718	718	-		
<b>M10</b>		<b>M20</b>		<b>M30</b>		<b>M40</b>		<b>M50</b>						
K M10 laminate								B M50 Velvet lacquer S M50 microstructure lacquer						
<b>M60</b>		<b>M70</b>		<b>M80</b>		<b>M90</b>								
		F M70 veneer / oak / walnut Z M70 Veneer / Bavaria		H M80 high gloss-Lacquer MP M80 laqué mat Premium										

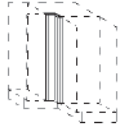

## Background filler 91 cm high

		Order no. W H D		Hinge side:	Carcase depth	Decor groups									
						M10	M20	M30	M40	M50	M60	M70	M80	M90	
 <p><b>Base unit background filler</b> Width: 20 cm For fitting flush with carcass</p>		<b>UPSL 00 91</b>				28,50	30	51	68	68	68	68	68	-	
<b>M 10</b> K M10 laminate	<b>M 20</b> D M20 Laminate decor	<b>M 30</b> I M30 RESOPAL PRO super matt IH M30 HPL PRO PW M30 PRIMEWOOD/Basic Veneer	<b>M 40</b> A M40 DIRECTLACK matt L M40 DIRECTLACK high-gloss	<b>M 50</b> B M50 Velvet lacquer P M50 Soft lacquer S M50 microstructure lacquer											
<b>M 60</b> QH M60 SMARTGLAS high-gloss QM M60 SMARTGLAS satin-finish	<b>M 70</b> F M70 veneer / oak / walnut Z M70 Veneer / Bavaria	<b>M 80</b> C1 M80 FENIX stainless-steel look H M80 high gloss-Lacquer MP M80 laqué mat Premium	<b>M 90</b>												

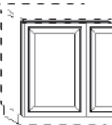

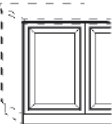

## Front filler 91 cm high

		Order no. W H D		Hinge side:	Carcase depth	Price groups								
						1	2	3	4	5	6	7	8	9
 <p><b>Base unit front filler</b> 3.5 - 10 cm 11 - 20 cm</p>		<b>UP 10 91</b>				57	57	57	105	105	105	110	121	-
		<b>UP 20 91</b>				60	64	71	140	140	140	146	161	-
 <p><b>Base unit front filler with buffer strip</b> 1 door 90.6 cm 10 - 20 cm</p>		<b>UPA 20 91</b>		R/L		93	93	100	149	149	149	169	186	-
<p><b>Base unit intermediate filler</b> 3.5 - 20 cm</p>		<b>UPZ 20 91</b>				64	64	71	140	140	140	146	161	-
						 <b>Not available for:</b> MIAMI, VIVA								

## Corner filler 91 cm high

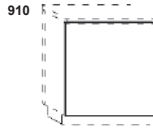
 <p><b>Base unit corner filler 90°</b> 11 x 11 cm up to 20 x 20 cm</p>		 <b>Important!</b> Planning dimensions 45 x 45 cm												
		<b>UPW 45 91</b>				96	96	109	122	122	122	136	150	-
		<b>UPW 54 91</b>				105	105	116	129	129	129	141	155	-

## Back cladding 91 cm high with screw-fitted fronts



906  <p><b>Back cladding</b> for base units, 91 cm high Carcass material With screw-fitted fronts 90.6 cm only available in grid sizes</p>	per 10 cm Width													
	<b>UVF 91</b>			38	41	45	64	66	69	75	83	-		
	 <b>Important!</b> Observe worktop excess depth 44.5 cm! The plinth panel required is supplied loose.													
906  <p><b>Back cladding</b> carcase material extends down to floor level With screw-fitted fronts 90.6 cm</p>	per 10 cm Width													
	<b>UVF 00 91</b>			38	41	45	64	66	69	75	83	-		
	<b>minimum price</b> - - - - - - - - - -													
	 <b>Important!</b> Observe worktop excess depth 44.5 cm! The plinth panel required is supplied loose.													



# Back cladding 91 cm high

		Order no. W H D		Hinge side:	Carcass depth	Decor groups								
		per 10 cm Width				M10	M20	M30	M40	M50	M60	M70	M80	M90
 <p><b>Back cladding</b> For raised bars 91 cm high, 16 mm thick</p>						9,10	15,50	44	57	57	57	57	57	-
M 10	M 20	M 30	M 40	M 50										
K M10 laminate	D M20 Laminate decor	I M30 RESOPAL PRO super matt IH M30 HPL PRO PW M30 PRIMEWOOD/Basic Veneer	A M40 DIRECTLACK matt L M40 DIRECTLACK high-gloss	B M50 Velvet lacquer S M50 microstructure lacquer										
M 60	M 70	M 80	M 90											
QH M60 SMARTGLAS high-gloss QM M60 SMARTGLAS satin-finish	F M70 veneer / oak / walnut Z M70 Veneer / Bavaria	C1 M80 FENIX stainless-steel look H M80 high gloss-Lacquer MP M80 laqué mat Premium												

## Visible sides / increased side depth 91 cm high

 <p><b>Base unit visible side</b></p>						0	0	72	72	96	96	118	148	-
 <p><b>Base unit increased side depth</b> Up to 90 cm side depth</p>						64	78	158	158	210	210	257	306	-

M 10	M 20	M 30	M 40	M 50										
K M10 laminate	D M20 Laminate decor	I M30 RESOPAL PRO super matt IH M30 HPL PRO PW M30 PRIMEWOOD/Basic Veneer	A M40 DIRECTLACK matt L M40 DIRECTLACK high-gloss	B M50 Velvet lacquer P M50 Soft lacquer RH M50 Velvet lacquer wood texture RW M50 Velvet lacquer spackle effect S M50 microstructure lacquer										
M 60	M 70	M 80	M 90											
QH M60 SMARTGLAS high-gloss QM M60 SMARTGLAS satin-finish	F M70 veneer / oak / walnut V M70 Velvet lacquer textured Z M70 Veneer / Bavaria	C1 M80 FENIX stainless-steel look H M80 high gloss-Lacquer MP M80 laqué mat Premium O M80 Veneered												

# 3.8

## Modular system Y kitchen accessories

The Y kitchen	XL 3.8.1
Design suggestions The Y kitchen	XL 3.8.2
Corner filler The Y kitchen	XL 3.8.3
Worktop connections The Y kitchen	XL 3.8.3
Accessories Base units 71.5 cm high	XL 3.8.4
Base unit accessories 65 cm high / 78 cm high	XL 3.8.5
Plinth panels	XL 3.8.6

### Legend:



Available with grip ledge N...



Not available with grip ledge N...



This symbol indicates which models are available



This symbol indicates which models are not available



Planning advice



Available carcass depths 34/45.5/55.5/61.0 cm



Available carcass depths 45.5/55.5/61.0 cm



Available carcass depths 55.5/61.0 cm

Modular system  
Y kitchen  
accessories



GERMAN  
DESIGN  
AWARD  
WINNER  
2018



GERMAN  
DESIGN  
AWARD  
WINNER  
2018



## The Y kitchen: A revolution - for a new generation

Complex furnishing issues demand simple answers, carefully considered in every last detail.

The new Y kitchen is a small revolution and the logical development of the classic island solution. Whether in a small town apartment or a generously proportioned house - the design of the Y kitchen turns your

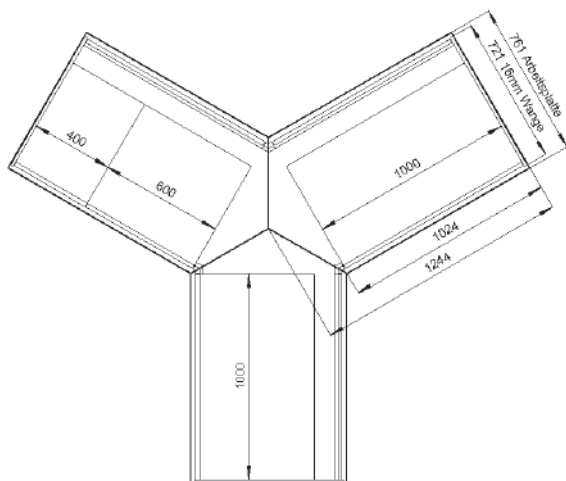
Kitchen into a central communication platform.

design by Michael Hilgers

The trained furniture designer and architect Michael Hilgers considers himself to be a design pioneer. In his works developed for renowned manufacturers, he always combines ingenuity with a minimalist design. Hilgers' innovative but at the same time amazingly simple furniture solutions exemplify his philosophy of questioning traditional product categories for today's living and working environment and rethinking them with pragmatism.

The (multi)functional, flexible and space-saving pioneering products developed in his Berlin studio have repeatedly won him awards, for example the Interior Innovation Award.

# Design suggestions The Y kitchen



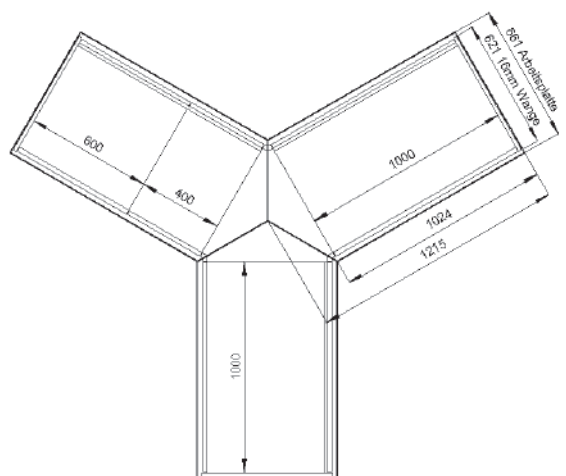
## Design suggestion 1:

3 sides with 100 cm total carcass dimensions  
16 mm panels as finish  
dishwasher 82 cm high

### consisting of:

3 Y-Base unit corner fillers 120°  
3 worktops Dimensions width: 124.4 cm, depth 76.1 cm  
3 worktops mitred connections  
Special mitre  
2 installation sets for hobs and sinks

**UPW 120 78**  
**AP16D 90**  
**AP16D-G00**  
**ES 16 60**



## Design suggestion 2:

3 sides with 100 cm total carcass dimensions  
16 mm panels as finish

### consisting of:

3 Y-Base unit corner fillers 120°  
3 worktops Dimensions width: 121.5 cm, depth 66.1 cm  
3 worktops mitred connections  
Special mitre  
2 installation sets for hobs and sinks

**UPW 120 78**  
**AP16D 90**  
**AP16D-G00**  
**ES 16 60**

## General planning advice and technical information on the Y kitchen:













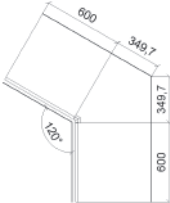
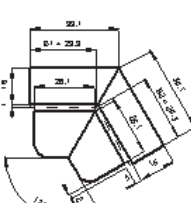
- For the installation of a dishwasher, sufficient space must be planned in at the rear; either via a spacefitter frame or via a 10 cm increased side depth
- Dishwashers may not be planned in at the end of a row
- When planning hob ventilators, note the minimum depth of the unit or minimum side depth
- With thin worktops, plan for an installation set for hobs, and observe the hob thickness and the installation regulations
- Do not plan rear panel against rear panel, otherwise they must be mitre-cut on site
- Handles not available: grip ledges N...

## Planning advice in conjunction with dishwasher with worktop thickness 16 mm:

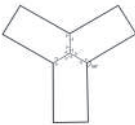








Attachment rails are necessary for all sinks and hobs. These are 25 mm high. This means that XL dishwashers cannot be planned below the sink drain unit, because the worktop sits directly above.

# Corner filler The Y kitchen

**Planning advice:**  
for a Y kitchen 3 base unit corner fillers 120° are required

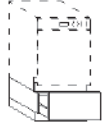



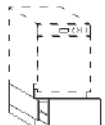


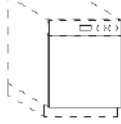


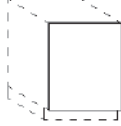

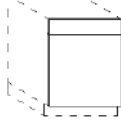


		Order no. W H D		Hinge side:	Carcase depth	Price groups								
						1	2	3	4	5	6	7	8	9
	<b>Y kitchen</b> <b>Base unit corner filler 120°</b> for carcase height 65 cm		Unit price <b>UPW 120 65</b>			98	98	110	123	123	123	159	175	-
	 <b>Not available for:</b> ALU TEC RP													
	<b>Y kitchen</b> <b>Base unit corner filler 120°</b> for carcase height 71.5 cm		Unit price <b>UPW 120 72</b>			98	98	110	123	123	123	159	175	-
	 <b>Not available for:</b> MIAMI, VIVA													
	<b>Y kitchen</b> <b>Base unit corner filler 120°</b> for carcase height 78 cm		Unit price <b>UPW 120 78</b>			99	99	111	125	125	125	163	179	-
	 <b>Not available for:</b> ALU TEC RP													
	<b>Y kitchen</b> <b>Base unit corner filler 120°</b> for carcase height 84.5 cm		Unit price <b>UPW 120 85</b>			99	99	111	125	125	125	163	179	-
	 <b>Not available for:</b> MIAMI, VIVA													
				<b>Planning advice</b> for a Y kitchen, 3 base unit corner fillers 120° are needed.										

# Worktop connections The Y kitchen

		Order no. W H D		Hinge side:	Carcase depth	Decor groups						
						AP AP D	AP 5D	AP 16D	AP 16R	AP 25D	AP 25R	
	<b>Worktop corner connection with special abutment joint</b> with tongue and groove and 2 tightening fittings		Unit price <b>AP 16 D-V00</b>			-	-	-	143	143	-	-
												
	<b>Worktop corner connection with special abutment joint</b> with tongue and groove and 2 tightening fittings		Unit price <b>AP-V 00</b>			143	143	-	-	-	143	143
												
	<b>Worktop corner connection with special mitre</b> with tongue and groove and 2 tightening fittings		Unit price <b>AP 16 D-G00</b>			-	-	-	117	117	-	-
												
	<b>Worktop corner connection with special mitre</b> with tongue and groove and 2 tightening fittings		Unit price <b>AP-G 00</b>			117	117	-	-	-	117	117
												

# Accessories Base units 71.5 cm high

▲ = Types also available with 61 cm carcass depth (order no. ... replace ... 55 ... with 61)




		Order no.		Price groups											
		W H D		Hinge side:	Carcass depth	1	2	3	4	5	6	7	8	9	
321  <p><i>Planning dimension 65 cm</i></p>	<b>Base for raised dishwasher</b> with top shelf, 22.0 cm high 1 drawer with pull-out panel 32.1 cm, angled at top, 45.5 cm deep 1 collection tray (available only in 60 cm width) Overall height 104 cm for 82 cm high dishwasher with front 71.1 cm high Overall height 110.5 cm for 86 cm high dishwasher with front 77.6 cm high		<b>UGS 45 10 55 871</b>	▲		258	263	290	352	375	399	430	473	-	
			<b>UGS 60 10 55 871</b>	▲		285	298	326	389	419	445	485	534	-	
		 <b>Not available for:</b> ALU TEC RP, MIAMI, VIVA													
		 <b>Important!</b> Plan free-standing with 25 mm panels													
321  <p><i>Planning dimension 65 cm</i></p>	<b>as above, but</b> only for dishwashers with <b>VARIO HINGE</b> with pull-out panel 32.1 cm not angled.		<b>UGV 60 10 55 871</b>	▲		285	298	326	389	419	445	485	534	-	
			 <b>Not available for:</b> MIAMI, VIVA												
		 <b>Important!</b> Plan free-standing with 25 mm panels													
581 	<b>Base unit door, 58.1 cm</b> as front panel for integrated dishwashers  44.6 cm wide with 45 cm 59.6 cm wide with 60 cm		 <b>Important!</b> Only plan large-volume dishwashers with a plinth height of at least 15 cm.												
			 <b>Not available for:</b> MIAMI, VIVA												
		<b>UT 45 59</b>				70	74	89	112	149	163	181	199	-	
		<b>UT 60 59</b>				82	85	99	134	178	188	216	238	-	
711 	<b>Base unit door, 71.1 cm</b> for integrated built-under fridges with door and fully integrated washing machines  44.6 cm wide with 45 cm 59.6 cm wide with 60 cm		 <b>Not available for:</b> MIAMI, VIVA												
			<b>UT 45 72 11</b>		R/L		96	100	108	120	186	207	244	268	-
		<b>UT 60 72 11</b>		R/L		108	112	122	134	218	236	281	309	-	
126 581 	<b>Base unit door, 71.1 cm</b> drawer panel 12.6 cm attached to door 58.1 cm As front panel for fully integrated dishwashers and pull-out fridges and freezers  44.6 cm wide with 45 cm 59.6 cm wide with 60 cm		 <b>Important!</b> Only plan large-volume dishwashers with a plinth height of at least 15 cm.												
			 <b>Not available for:</b> MIAMI, VIVA												
		<b>UTV 45 72</b>				96	100	108	120	186	207	244	268	-	
		<b>UTV 60 72</b>				108	112	122	134	218	236	281	309	-	



# Base unit accessories 65 cm high / 78 cm high

				Price groups										
		Order no.		Hinge side:	Carcase depth	1	2	3	4	5	6	7	8	9
		W H D												
<p>256</p> <p>Overall height 104 cm Planning dimension 65 cm</p>		<p><b>UGS 45 10 55 87</b></p>	▲	251	258	280	341	369	391	422	464	-		
		<p><b>UGS 60 10 55 87</b></p>	▲	276	290	320	378	412	439	480	528	-		
		<p><b>Not available for:</b> ALU TEC RP</p>												
		<p><b>Important!</b> Plan free-standing with 25 mm panels</p>												
<p>256</p> <p>Overall height 104 cm Planning dimension 65 cm</p>		<p><b>UGV 60 10 55 87</b></p>	▲	276	290	320	378	412	439	480	528	-		
				<p><b>Important!</b> Plan free-standing with 25 mm panels</p>										
<p>386</p> <p>Overall height 117 cm Planning dimension 65 cm</p>		<p><b>UGS 45 11 55 87</b></p>	▲	258	263	290	352	375	399	430	473	-		
		<p><b>UGS 60 11 55 87</b></p>	▲	285	298	326	389	419	445	485	534	-		
		<p><b>Not available for:</b> ALU TEC RP</p>												
		<p><b>Important!</b> Plan free-standing with 25 mm panels</p>												
<p>386</p> <p>Overall height 117 cm Planning dimension 65 cm</p>		<p><b>UGV 60 11 55 87</b></p>	▲	285	298	326	389	419	445	485	534	-		
				<p><b>Important!</b> Plan free-standing with 25 mm panels</p>										
<p>646</p>		<p><b>UT 45 65</b></p>		96	100	108	120	186	207	244	268	-		
		<p><b>UT 60 65 2</b></p>		108	112	122	134	218	236	281	309	-		
<p>776</p>		<p><b>Always order article DL 60 6 if a high-volume dishwasher has not been included in planning!</b></p>												
		<p><b>UT 45 78 1</b></p>		111	116	122	134	204	220	257	283	-		
		<p><b>UT 60 78 1</b></p>		122	126	138	146	232	253	294	323	-		
<p>126 646</p> <p>44.6 cm wide with 45 cm Surcharge in connection with the grip rails N700 and N775 incl. connecting plate and additional grip rails</p> <p>59.6 cm wide with 60 cm Surcharge in connection with the grip rails N700 and N775 incl. connecting plate and additional grip rails</p>		<p><b>UTV 45 78</b></p>		111	116	122	134	204	220	257	283	-		
		<p><b>Extra charge for MP-GSN...</b></p>			145	145	145	145	145	145	145	145	-	
		<p><b>UTV 60 78</b></p>		122	126	138	146	232	253	294	323	-		
		<p><b>Extra charge for MP-GSN...</b></p>			148	148	148	148	148	148	148	148	-	

# Plinth panels

			Decor groups												
			M10	M20	M30	M40	M50	M60	M70	M80	M90	M100	M110		
<b>Plinth panels</b> 5, 7.5, 10, 12.5, 15, 17.5, 20 cm high W= 10, 15, 20 cm high 16 mm thick with PVC sealing profile	per 10 cm Width	Order no. W H D	<b>Z 33</b>	0	1,40	5,50	7,30	7,30	7,30	7,30	7,30	7,30	-	5,20	-
			K max. length 408 cm / D max. length 260 cm E max. length 270 cm / S/B/J max. length 270 cm F max. length 270 cm / H max. length 270 cm M max. length 270 cm / L/A max. length 260 cm I max. length 350 cm / C1 max. length 270 cm C max. length 360 cm / O max. length 270 cm Q max. length 278 cm / R max. length 270 cm / W max. length 400 cm												
<b>Plinth panel as additional order</b>	per 10 cm Width	<b>Z 33Z</b>	2	3,80	7,20	9,60	9,60	9,60	9,60	9,60	9,60	9,60	-	7,30	-
			K max. length 408 cm / D max. length 260 cm E max. length 270 cm / S/B/J max. length 270 cm F max. length 270 cm / H max. length 270 cm M max. length 270 cm / L/A max. length 260 cm I max. length 350 cm / C1 max. length 270 cm C max. length 360 cm / O max. length 270 cm Q max. length 278 cm / R max. length 270 cm Q max. length 278 cm / W max. length 400 cm												
<b>Plinth panel in louvre-effect</b> 10 cm, 15 cm or 20 cm high, Max. length 490 cm Finish: Aluminium anodised/surface E6/Inox Aluminium anodised black incl. side plinth, plinth corners and sealing profile	per 10 cm Width	<b>Z 33SOLO</b>	-	-	-	-	-	-	-	-	-	-	-	-	19
			<b>Note:</b> Ventilation cross section of the louvre plinth per 100 cm at Plinth height 10 cm: 163.33 cm <sup>2</sup> Plinth height 15 cm: 401.66 cm <sup>2</sup> Plinth height 20 cm: 435.00 cm <sup>2</sup>												
<b>Plinth panel in louvre-effect as additional order</b> 10 cm, 15 cm or 20 cm high, Max. length 500 cm Finish: Aluminium anodised/surface E6/Inox Aluminium anodised black	per 10 cm Width	<b>Z 33SOLO Z</b>	-	-	-	-	-	-	-	-	-	-	-	-	21
<b>Inside corner for plinth panel in louvre-effect</b>	Unit price	<b>Z 33SOLO I</b>	7,30												
<b>Outside corner for plinth panel in louvre-effect</b>	Unit price	<b>Z 33SOLO A</b>	7,30												
<b>K M10 laminate</b> K005S Castell Oak K006P Light Grey K023P Stainless Steel Colour K039G Premium white glossy K039P Premium white K043P Graphite Black K058P Magic-grey K075P Black K076P Macaron K160F Snow White K160G Snow White Gloss K178F White Agate K190S Mammoth oak natural K199S Piemont Oak K216S natural mountain oak K218P Light Pepper K229S Classic Oak K230P Art Pepper K235P Titan Steel K236S Diamond Oak effect K247S Dark Maron effect K248P Light Nude K262S Royal Oak effect K263P Fango K269S Mountain Wood K270S Elegant walnut effect <b>D M20 Laminate decor</b> D039F Premium white matt D147S Burnt Wood D149W Brown concrete effect D160F Snow white matt D176S black Sherwood D178F White Agate matt D187W Concrete effect opal D188W Concrete effect pearl grey D202S Sepia Grey Sherwood D212W graphite concrete effect D224S bordeaux oak D250S Black Oak effect D251S Seal Oak effect D264S Light oak, grooved look D265S Dark oak, grooved look D271W Natural sandstone effect D272F Jade pastel <b>I M30 RESOPAL PRO super matt</b> I039M Premium white I075M Black I076M Macaron powder I138M Titanium grey I139M Jura Grey I140M anthracite	I141M cool white I240M Light Powder I241M Dark Powder I253M Moonlight Green I267M brown powder I268M nature powder IH M30 HPL PRO I273H Natural onyx effect I274H Navyblue I280H Smoke Powder I281H Ferro black gold <b>PW M30 PRIMEWOOD/Basic Veneer</b> PW258 Gavi oak Basic veneer PW259 Dark oak basic veneer <b>A M40 DIRECTLACK matt</b> A039M Premium white A043M Graphite Black A075M Black A076M Macaron A160M Snow White A178M White Agate A218M Light Pepper matt A230M Art Pepper A248M Light Nude A263M Fango <b>L M40 DIRECTLACK high-gloss</b> L039H Premium white L076H Macaron L160H Snow White L178H White Agate L218H Light Pepper L248H Light Nude <b>B M50 Velvet lacquer</b> B006F Light Grey B039F Premium white B043F Graphite Black B058F Magic-grey B075F Black B076F Macaron B099F special colour B160F Snow White B178F White Agate B218F Light Pepper B230F Art Pepper B245F Night Green B248F Light Nude B263F Fango <b>RH M50 Velvet lacquer wood texture</b> R006H Light Grey R039H Premium white R043H Graphite Black	R058H Magic-grey R075H Black R076H Macaron R099H special colour R160H Snow White R178H White Agate R218H Light Pepper R230H Art Pepper R245H Night Green R248H Light Nude R263H Fango <b>RW M50 Velvet lacquer spackle effect</b> R006W Light Grey R039W Premium white R043W Graphite Black R058W Magic-grey R075W Black R076W Macaron R099W special colour R160W Snow White R178W White Agate R218W Light Pepper R230W Art Pepper R245W Night Green R248W Light Nude R263W Fango <b>S M50 microstructure lacquer</b> S006P Light Grey S039P Premium white S043P Graphite Black S058P Magic-grey S075P Black S076P Macaron S099P special colour S160P Snow White S178P White Agate S218P Light Pepper S230P Art Pepper S245P Night Green S248P Light Nude S263P Fango <b>QH M60 SMARTGLAS high-gloss</b> Q075H Black Q160H Snow White Q178H White Agate Q191H Sand grey Q200H Carrara white Q201H Cream Q160H Snow White Q178H White Agate Q191H Sand grey Q200H Carrara white Q201H Cream <b>QM M60 SMARTGLAS satin-finish</b> Q075M Black Q160M Snow White	Q178M White Agate Q191M Sand grey Q192M Taupe Q200M Carrara white Q201M Cream Q234M Carbon metallic satin-finish Q244M Aqua Q254M Black metallic Q255M Champagne metallic Q256M Grey metallic Q277M Silk Metallic Q278M Bronze Metallic <b>F M70 veneer / oak / walnut</b> F039S Premium white F043S Graphite Black F058K silk grey F075S Black F076K Macaron F099K special colour F213K natural F214K coffee brown F218S Light Pepper F230S Art Pepper F231K Walnut Veneer F245S Night Green F248S Light Nude F257K Rosso F258K Gavi F259K Dark oak stained F261K Urban Oak F263S Fango F279K Moderno Rustico oak stained <b>V M70 Velvet lacquer textured</b> V182W Silver Metallic V183W Gold Metallic V194W Copper Metallic V195W Bronze Metallic V235W Titan Steel metallic V246W Basalt Metallic <b>Z M70 Veneer / Bavaria</b> Z039S Premium white Z043S Graphite Black Z058K silk grey Z075S Black Z076K Macaron Z099K special colour Z213K natural Z214K coffee brown Z218S Light Pepper Z230S Art Pepper Z245S Night Green Z248S Light Nude	Z258K Gavi oak Z259K Dark oak stained Z261K Urban Oak Z263S Fango Z279K Moderno Rustico oak stained <b>C1 M80 FENIX stainless-steel look</b> C023M Stainless Steel Look <b>H M80 high gloss-Lacquer</b> H006H Light Grey H039H Premium white H043H Graphite Black H058H Magic-grey H075H Black H076H Macaron H099H special colour H160H Snow White H178H White Agate H218H Light Pepper H230H Art Pepper H245H Night Green H248H Light Nude H263H Fango <b>MP M80 laqué mat Premium</b> MP006 Light Grey MP039 Premium white MP043 Graphite Black MP058 Magic-grey MP075 Black MP076 Macaron MP099 special colour MP160 Snow White MP178 White Agate MP218 Light Pepper MP230 Art Pepper MP245 Night Green MP248 Light Nude MP263 Fango <b>O M80 Veneered</b> O170S Antique Oak O197S Light Spessart oak O215S larch O232S Leached Spessart oak O233S Honey Spessart oak O259K Dark oak stained, brushed <b>W M100 Laminat Waterproof</b> W023M St. Steel Coloured Foiled <b>E1 M110 Lamella effect</b> E023F Aluminium inox lamella effect E075F Aluminium black lamella effect											

# 3.9

## Sliding door solutions for base units

Sliding door system SlideLine M	XL 3.9.1
Base units and sliding doors for Slideline M	XL 3.9.2-XL 3.9.3
Fittings for sliding doors SlideLine M	XL 3.9.3

### Legend:



Available with grip ledge N...



Not available with grip ledge N...



This symbol indicates which models are available



This symbol indicates which models are not available



wall-mounted units



available depths for wall-mounted units



Planning advice



Available carcass depths 34/45.5/55.5/61.0 cm



Available carcass depths 45.5/55.5/61.0 cm



Available carcass depths 55.5/61.0 cm



# Sliding door system SlideLine M



## Design in motion

SlideLine M upgrades the practical value and design of furniture:

wall, tall and base units in kitchen planning, and living room units made from the panel and shelf unit system.

### It's your ideas that decide.

With SlideLine M simple shelf units become appealing

functional furniture with looks that can be changed again and again.

Sliding the doors to different positions creates ever-changing constellations of open and closed elements. This gets things moving in your furniture design and never fails to please. It's your ideas that decide.

Discover the wealth of applications for SlideLine M.

## Note:

Always use sliding door systems in isolation, because the fitting with front-flush shelves adds 33 mm, thus protruding beyond standard units.

## Base units:

Carcase widths:  
45 cm, 50 cm, 60 cm, 80 cm, 90 cm  
Carcase depths: 57.5 cm, 47.5 cm, 36.1 cm  
Door widths: 45 cm, 50 cm, 60 cm, 80 cm, 90 cm  
Door heights: 39 cm, 52 cm, 65 cm, 71.5 cm, 78 cm

## Wall units:

Carcase widths:  
45 cm, 50 cm, 60 cm, 80 cm, 90 cm  
Carcase depth: 36.1 cm  
Door widths: 45 cm, 50 cm, 60 cm, 80 cm, 90 cm  
Door heights: 39 cm, 52 cm, 65 cm, 78 cm, 91 cm

## Tall units:

Carcase widths:  
30 cm, 40 cm, 45 cm, 50 cm, 60 cm  
Carcase depths: 57.5 cm, 47.5 cm, 36.1 cm  
Door widths: 90 cm  
Door heights: 143 cm, 156 cm, 168.8 cm, 181.8 cm, 194.8 cm, 207.8 cm, 220.8 cm

**Important:** Because of fixed front width of 90 cm, the following carcass width combinations are possible (45/45 cm, 40/50 cm, 60/30 cm)

## Why SlideLine M?

Simple shelf units become appealing functional furniture with looks that can be changed again and again.

SlideLine M facilitates the playful interchange between open and closed sections.

The SlideLine M sliding door system ensures that no open doors are ever in the way, so do not create an obstruction in tight passages.

The smooth running action adds to the comfort, as does the cushioned closing of even heavy doors.

High-quality function and smart design, since the Silent System cushioning is integrated, out of sight, on the inside of the front.

Even with several doors in one profile, they can still be cushioned to ensure blissful piece and quiet.

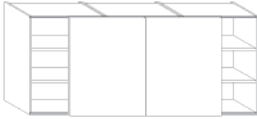
And because the end position of the doors can be chosen to suit, the end customer has a high level of design freedom.


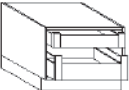

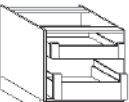

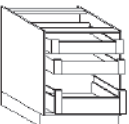

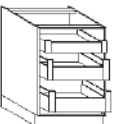
# Base units and sliding doors for Slideline M

The shelf elements UR..., HR... and GR... are also available for planning. These items are to be found in the sections Base units, Wall units and Tall units.

■ = Models also available in 34/45.5/61 cm carcass depth (Order no.: ... replace ... 55 ... with 34/45/61)


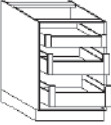
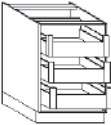

**Design suggestion in conjunction with wall shelf unit consisting of:**  
 3 x HR 60 78 34  
 2 x SLHF 60 78  
 1 x SL-SET 19



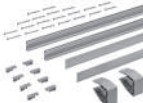

	Order no. W H D	Hinge side: Carcass depth	Price groups																	
			1	2	3	4	5	6	7	8	9									
<b>386</b>  <b>Sliding door for base units height 39 cm</b> 38.6 cm high complete with fittings			SLUF 45 39	223	246	278	324	329	332	383	421	-								
			SLUF 50 39	227	252	287	339	345	351	407	448	-								
			SLUF 60 39	233	262	306	369	375	379	446	491	-								
			SLUF 80 39	246	285	342	427	438	444	535	589	-								
			SLUF 90 39	252	297	361	458	469	478	578	636	-								
 <b>Base unit for sliding door</b> without front 1 internal drawer 1 internal pull-out  <i>Carcass height 39 cm</i>	34, 45.5, 55.5, 61.0		SLU 45 39 55 11	■	442															
			SLU 50 39 55 11	■	442															
			SLU 60 39 55 11	■	461															
			SLU 80 39 55 11	■	622															
			SLU 90 39 55 11	■	622															
<b>516</b>  <b>Sliding door for base units height 52 cm</b> 51.6 cm high complete with fittings			SLUF 45 52	233	262	306	369	375	379	446	491	-								
			SLUF 50 52	236	270	319	389	398	403	478	526	-								
			SLUF 60 52	246	285	342	427	438	444	535	589	-								
			SLUF 80 52	261	316	392	506	522	531	649	714	-								
			SLUF 90 52	270	330	417	547	561	572	707	778	-								
 <b>Base unit for sliding door</b> without front 1 internal drawer 1 internal pull-out  <i>Carcass height 52 cm</i>	34, 45.5, 55.5, 61.0		SLU 45 52 55 11	■	478															
			SLU 50 52 55 11	■	478															
			SLU 60 52 55 11	■	508															
			SLU 80 52 55 11	■	785															
			SLU 90 52 55 11	■	785															
<b>646</b>  <b>Sliding door for base units height 65 cm</b> 64.6 cm high complete with fittings			SLUF 45 65	242	280	332	414	422	427	513	564	-								
			SLUF 50 65	249	288	349	438	446	455	548	603	-								
			SLUF 60 65	258	308	377	488	499	507	621	683	-								
			SLUF 80 65	279	346	441	586	603	615	764	840	-								
			SLUF 90 65	290	365	473	638	654	667	837	921	-								
 <b>Base unit for sliding door</b> without front 2 internal drawers 1 internal pull-out  <i>Carcass height 65 cm</i>	34, 45.5, 55.5, 61.0		SLU 45 65 55 21	■	523															
			SLU 50 65 55 21	■	523															
			SLU 60 65 55 21	■	554															
			SLU 80 65 55 21	■	830															
			SLU 90 65 55 21	■	830															
<b>711</b>  <b>Sliding door for base units height 71.5 cm</b> 71.1 cm high complete with fittings			SLUF 45 72	248	288	349	437	446	455	547	602	-								
			SLUF 50 72	253	300	366	465	477	484	586	645	-								
			SLUF 60 72	264	321	400	522	533	543	666	733	-								
			SLUF 80 72	287	363	469	629	648	660	826	909	-								
			SLUF 90 72	300	381	501	686	704	719	905	996	-								
 <b>Base unit for sliding door</b> without front 1 internal drawer 2 internal pull-outs  <i>Carcass height 71.5 cm</i>			SLU 45 72 55 12	■	523															
			SLU 50 72 55 12	■	523															
			SLU 60 72 55 12	■	554															
			SLU 80 72 55 12	■	830															
			SLU 90 72 55 12	■	830															

# Base units and sliding doors for Slideline M

The shelf elements UR..., HR... and GR... are also available for planning. These items are to be found in the sections Base units, Wall units and Tall units.

		Price groups																			
		Order no.									Hinge side:	Carcase depth:									
		W	H	D									1								
776	 <p><b>Sliding door for base units height 78 cm</b> 77.6 cm high complete with fittings</p>	<b>SLUF 45 78</b>										252	297	361	458	469	478	578	636	-	
		<b>SLUF 50 78</b>											258	308	377	488	499	507	621	683	-
		<b>SLUF 60 78</b>											270	330	417	547	561	572	707	778	-
		<b>SLUF 80 78</b>											297	375	491	666	686	700	879	967	-
		<b>SLUF 90 78</b>											308	400	528	726	747	764	966	1063	-
		<p>Width 45, 50, 60 Not available for: MIAMI, VIVA                      Width 80, 90 Not available for: ALUELEMENTS, ATLANTA-B, ATLANTA-S, BERGEN, CASTELLO, CHALET-B, CHALET-S, CHICAGO, FRAME, GENT, LUGANO, LUX-B, MIAMI, NOBEL-B, NOBEL-S, ORLANDO-B, ORLANDO-S, OSLO 15, PALERMO-B, PALERMO-S, ROMA-B, ROMA-S, SMART MIRROR, SOFIE-B, SOFIE-S, STRIP ELEMENTS, TESSIN 15, TIM 15, VILLAGE 15-B, VILLAGE 15-S, VINO, VIVA, YORK-B, YORK-S</p>																			
 <p><b>Base unit for sliding door</b> without front 1 internal drawer 2 internal pull-outs</p> <p>Carcase height 78 cm</p>	<b>SLU 45 78 55 12</b>											■	554								
	<b>SLU 50 78 55 12</b>											■	554								
	<b>SLU 60 78 55 12</b>											■	586								
	<b>SLU 80 78 55 12</b>											■	866								
	<b>SLU 90 78 55 12</b>											■	869								
 <p><b>Base unit for sliding door</b> without front 3 internal pull-outs</p> <p>Carcase height 78 cm</p>	<b>SLU 45 78 55 03</b>											■	604								
	<b>SLU 50 78 55 03</b>											■	604								
	<b>SLU 60 78 55 03</b>											■	638								
	<b>SLU 80 78 55 03</b>											■	917								
	<b>SLU 90 78 55 03</b>											■	920								
 <p><b>Base unit for sliding door</b> without front 2 internal drawers 2 internal pull-outs</p> <p>Carcase height 78 cm</p>	<b>SLU 45 78 55 22</b>											■	665								
	<b>SLU 50 78 55 22</b>											■	667								
	<b>SLU 60 78 55 22</b>											■	705								
	<b>SLU 80 78 55 22</b>											■	1001								
	<b>SLU 90 78 55 22</b>											■	1009								

## Fittings for sliding doors SlideLine M

 <p><b>Fittings for sliding doors profile set</b> <b>For shelf thickness 19 mm</b> Complete with top and bottom runner profile (aluminium anodised) and ABS decor profile to be glued 300 cm long, to be shortened on-site Incl. end caps and assembly clips Fixing screws</p>	<b>SL-SET19</b>																				
																					





# 4

## Worktop and aperture design

Worktops	XL/GL 4.1.1
Worktops 38 mm with postformed edge	XL/GL 4.1.1-XL/GL 4.1.2
Worktops 38 mm with thick edge	XL/GL 4.1.3-XL/GL 4.1.4
Worktops 48 mm	XL/GL 4.1.5-XL/GL 4.1.6
Slim-line worktops 16 mm	XL/GL 4.1.7-XL/GL 4.1.8
Worktops 25 mm	XL/GL 4.1.9-XL/GL 4.1.10
Bar tops 100 mm	XL/GL 4.1.11
Recess back panels	XL/GL 4.1.12-XL/GL 4.1.13
Glass recess back panels	XL/GL 4.1.14
Lighting for recess back panels	XL/GL 4.1.15
Upstand system	XL/GL 4.1.16
Recess back panels, printed motif	XL/GL 4.1.17-XL/GL 4.1.18
Sliding doors / aperture design SlideLine M 2-rail	XL/GL 4.1.19
Accessories worktops / apertures	XL/GL 4.1.20
Table attachment tops with thick edge 38 mm thick	XL/GL 4.1.21-XL/GL 4.1.24








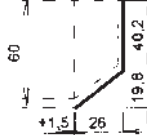

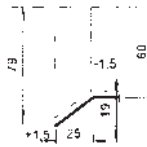


### Product benefits:

- all available 38 mm worktop decors can be combined with all PP edgings from the worktop range at no extra cost
- any chosen custom shapes, wherever technically feasible
- 48 worktop decors
- range features 48 price-reduced add-on tables

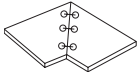
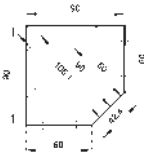

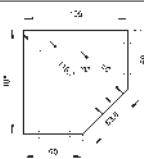

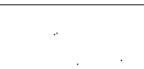
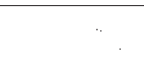

4  
Worktop and  
aperture design



# Worktops 38 mm with postformed edge

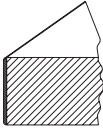




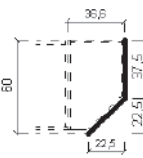
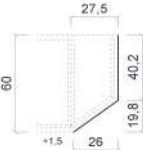


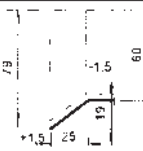


			Decor groups							
			AP	AP D	AP 5D	AP 16D	AP 16R	AP 25D	AP 25R	
<b>Worktop</b> Front edge with double rounded profile Laminate surface 			Order no.							
			W	H	D					
			Hinge side:	Carcass depth						
			AP max. length 510 cm							
up to 60 cm depth			per 10 cm Width							
			<b>AP 60</b>	10,10	-	-	-	-	-	-
up to 63 cm depth			per 10 cm Width							
			<b>AP 63</b>	17,20	-	-	-	-	-	-
up to 65 cm depth			per 10 cm Width							
			<b>AP 65</b>	17,20	-	-	-	-	-	-
from 61 - 90 cm depth			per 10 cm Width							
			<b>AP 90</b>	17,20	-	-	-	-	-	-
from 91 - 120 cm depth			per 10 cm Width							
			<b>AP 120</b>	22,20	-	-	-	-	-	-
AP Laminate 38 mm/Postformed	3157	Piemont Oak	6290	Ferro black gold						
1180 natural mountain oak	3797	Mocca	6307	Natural onyx effect						
1210 Metal Rock anthracite	4262	Castell Oak	8000	Crystal marble						
1369 Dark Maron effect	4268	natural Green Ceramic	9200	Cupria marble						
1385 Royal Oak effect	4326	Elegant walnut effect	9386	Seal Oak effect						
2032 Wild Oak	4374	Concrete effect opal	9612	Graphite Black stone look						
2240 Diamond oak effect	4375	Concrete effect pearl grey	9630	Art Pepper stone look						
2260 Sand beige titanite	4440	graphite concrete effect								
2406 Mountain Wood	5411	Mammoth oak natural								
2650 Natural sandstone effect	5573	Classic Oak								
2701 snow white spatula look effect	5579	Brown concrete effect								
 <b>Extra charge for edging</b> of the worktops at rear and side inset postformed edge at rear or side (max. length 250 cm)			per 10 cm Width							
			<b>AP-K 00</b>	25	-	-	-	-	-	-
			 <b>Important!</b> The glue seams are visible and therefore do not constitute grounds for complaint!							
 <b>Extra charge for edging</b> of the worktops at rear and side thick edge (side without charge)			per 10 cm Width							
			<b>APD-K 00</b>	3,40	3,40	-	-	-	3,40	3,40
 <b>Worktop cutout</b> For hobs, sinks, ventilation grilles, etc.			Unit price							
			<b>AP-A 00</b>	30	30	30	-	-	-	-
 <b>Worktop angled cut                      at the end of a row</b> with return variable, with 2-part inset postformed edge			Unit price							
			<b>AP-S 01</b>	200	-	-	-	-	-	-
 <b>Worktop angled cut                      at the end of row 45°</b> for base shelf end units 25 cm and 34 cm wide (models URA 25 and URA 34), with inset postformed edge worktop overhang 4.5 cm			Unit price							
			<b>AP-S 45</b>	179	-	-	-	-	-	-
 <b>Worktop angled cut                      at the end of row 37.2°</b> For base units, angled, 25 cm wide (US 25..)                     with inset postformed edge, worktop overhang 2.5 cm			Unit price							
			<b>AP-S 37</b>	179	-	-	-	-	-	-
 <b>Worktop 90° angled cutout                      at the end of a row</b> with return with 3-part inset postformed edge (max. length 250 cm, min. 10 cm deep)			per 10 cm Width							
			<b>AP-W 90</b>	25	-	-	-	-	-	-
 <b>Worktop angled cutout                      in the middle of row</b> for US 25.. with 2-part inset postformed edge			per 10 cm Width							
			<b>AP-W 37</b>	25	-	-	-	-	-	-
 <b>Worktop corner connection, 90°</b> with tongue and groove and 2 tightening fittings (length for mitre added at the factory free of charge).			Unit price							
			<b>AP-V 90</b>	37	37	-	-	-	37	37
 <b>Worktop corner connection, 135°</b> with tongue and groove and 2 tightening fittings (length for mitre added at the factory free of charge).			Unit price							
			<b>AP-V 135</b>	37	37	-	-	-	37	37
<b>Worktop corner connection                      with special abutment joint</b> with tongue and groove and 2 tightening fittings			Unit price							
			<b>AP-V 00</b>	143	143	-	-	-	143	143

# Worktops 38 mm with postformed edge

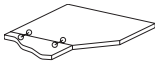
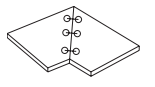
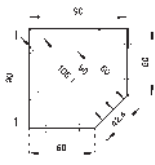

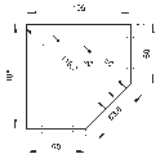

	Order no. W H D	Hinge side: Carcase depth	Decor groups								
			AP	AP D	AP 5D	AP 16D	AP 16R	AP 25D	AP 25R		
 <p><b>Worktop corner connection, 45°</b> with tongue and groove and 3 tightening fittings</p>	Unit price										
	<b>AP-G 45</b>		54	54	-	-	-	54	54		
<p><b>Worktop corner connection with special mitre</b> with tongue and groove and 2 tightening fittings</p>	Unit price										
	<b>AP-G 00</b>		117	117	-	-	-	117	117		
 <p><b>Corner worktop 90 x 90 cm</b> Front edge with double rounded profile</p> <p>60 cm deep</p> <p>90 cm deep</p> <p>106.1 cm deep</p>	Unit price										
	<b>AP E 90 60</b>		205	-	-	-	-	-	-		
	Unit price										
	<b>AP E 90 90</b>		328	-	-	-	-	-	-		
 <p><b>Corner worktop 92 x 60 cm</b> Front edge with double rounded profile with 22.5° mitre on left and right side and tongue and groove with tightening screw</p> <p>60 cm deep</p> <p>90 cm deep</p> <p>106.1 cm deep</p>	Unit price										
	<b>AP E 92 60</b>		205	-	-	-	-	-	-		
	Unit price										
	<b>AP E 92 90</b>		328	-	-	-	-	-	-		
 <p><b>Corner worktop 105 x 105 cm</b> Front edge with double rounded profile</p> <p>60 cm deep</p> <p>90 cm deep</p> <p>116.7 cm deep</p>	Unit price										
	<b>AP E 105 60</b>		205	-	-	-	-	-	-		
	Unit price										
	<b>AP E 105 90</b>		328	-	-	-	-	-	-		
 <p><b>Corner worktop 113 x 60 cm</b> Front edge with double rounded profile with 22.5° mitre on left and right side and tongue and groove with tightening screw</p> <p>60 cm deep</p> <p>90 cm deep</p> <p>116.7 cm deep</p>	Unit price										
	<b>AP E 113 60</b>		205	-	-	-	-	-	-		
	Unit price										
	<b>AP E 113 90</b>		328	-	-	-	-	-	-		
 <p><b>Worktop gallery, front edge with double rounded profile</b> 8.5 cm high, for corner worktop 90 x 90 cm (51 x 51 cm)</p>	Unit price										
	<b>AE 90</b>		144	-	-	-	-	-	-		
 <p><b>Worktop gallery, front edge with double rounded profile</b> 8.5 cm high, for corner worktop 105 x 105 cm (69 x 69 cm)</p>	Unit price										
	<b>AE 105</b>		144	-	-	-	-	-	-		
<p><b>Laminate (all decors)</b> <b>max. 270 x 125 cm</b> approx. 0.8 mm thick minimum price, apart from FENIX colours</p>	pro m <sup>2</sup> , B x D										
	<b>Z 32</b>		78	78	78	78	110	78	110		
<p> <b>Important!</b> 1st dimension = direction of grain. <b>Not available for:</b> FENIX decors</p>											



# Worktops 38 mm with thick edge

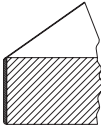




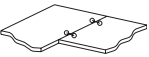
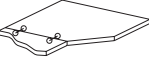


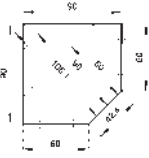

		Order no. W H D	Hinge side: Carcase depth	Decor groups					
				AP	AP D	AP 5D	AP 16D	AP 16R	AP 25D
 <p><b>Worktop</b> Front edge with thick edge, 1.5 mm Laminate surface</p> <p>up to 60 cm depth</p> <p>up to 63 cm depth</p> <p>up to 65 cm depth</p> <p>from 61 - 90 cm depth</p> <p>from 91 - 118 cm depth</p>	 <b>APD max. length 510 cm</b>								
	per 10 cm Width								
	<b>APD 60</b>			-	11,60	-	-	-	-
	per 10 cm Width								
	<b>APD 63</b>			-	18,70	-	-	-	-
	per 10 cm Width								
<b>APD 65</b>			-	18,70	-	-	-	-	
per 10 cm Width									
<b>APD 90</b>			-	18,70	-	-	-	-	
per 10 cm Width									
<b>APD 118</b>			-	23,30	-	-	-	-	
Worktop decor 38 mm APD Laminate 38 mm/Thick Edge 1180 natural mountain oak 1200 Roxano volcano black 1210 Metal Rock anthracite 1369 Dark Maron effect 1385 Royal Oak effect 2032 Wild Oak 2240 Diamond oak effect 2260 Sand beige titanite 2406 Mountain Wood	2650 <b>Natural sandstone effect</b> 2701 snow white spatula look effect 3157 Piemont Oak 3797 Mocca 4262 Castell Oak 4268 natural Green Ceramic 4326 Elegant walnut effect 4374 Concrete effect opal 4375 Concrete effect pearl grey 4440 graphite concrete effect 5411 Mammoth oak natural	5573 Classic Oak 5579 Brown concrete effect 6290 Ferro black gold 6307 Natural onyx effect 8000 Crystal marble 9200 Cupria marble 9386 Seal Oak effect 9612 Graphite Black stone look 9630 Art Pepper stone look							
 <p><b>Extra charge for edging</b> of the worktops at rear and side thick edge (side without charge)</p>	per 10 cm Width								
	<b>APD-K 00</b>		3,40	3,40	-	-	3,40	3,40	
 <p><b>Worktop cutout</b> For hobs, sinks, ventilation grilles, etc.</p>	Unit price								
	<b>AP-A 00</b>		30	30	30	-	-	-	
 <p><b>Worktop angled cut at the end of a row with return</b> variable, with thick edge (rounded corners R=25 mm)</p>	Unit price								
	<b>APD-S 01</b>		-	75	-	-	75	75	
 <p><b>Worktop angled cut at the end of row 45°</b> for base shelf end units 25 cm and 34 cm wide (models URA 25.. and URA 34..), with thick edge worktop overhang 4.5 cm (rounded corners R=25 mm)</p>	Unit price								
	<b>APD-S 45</b>		-	63	-	-	63	63	
 <p><b>Worktop angled cut at the end of row 37.2°</b> For base units, angled, 25 cm wide (US 25..) with thick edge, worktop overhang 2.5 cm (rounded corners R=25 mm)</p>	Unit price								
	<b>APD-S 37</b>		-	63	-	-	63	63	
 <p><b>Worktop 90° angled cutout at the end of a row with return</b> with thick edge (only available with inside radius R = 65 mm) (min. 10 cm deep)</p>	per 10 cm Width								
	<b>APD-W91</b>		-	7,50	-	-	7,50	7,50	
 <p><b>Worktop 90° angled cutout at the end of a row WITHOUT inside radius, square</b> with return (min. 10 cm deep) minimum size 5 x 5 cm, maximum cutout length 350 cm (square cutout cannot be combined with rounded cutout or corners)</p>	per 10 cm Width								
	<b>APD-WE90</b>		-	25	-	-	25	25	
 <p><b>Worktop angled cutout in the middle of row</b> For US 25.. with thick edge (calculate angle with 40 cm)</p>	per 10 cm Width								
	<b>APD-W37</b>		-	7,50	-	-	7,50	7,50	
 <p><b>Worktop rounding for Worktops with thick edge</b> Standard roundings at front, 25 mm radius instead of straight side edges left and right are included in the worktop price (model APD)</p>	Unit price								
	<b>APD-R 00</b>		-	109	-	-	109	109	
 <p><b>Worktop corner connection, 90°</b> with tongue and groove and 2 tightening fittings (length for mitre added at the factory free of charge).</p>	Unit price								
	<b>AP-V 90</b>		37	37	-	-	37	37	

# Worktops 38 mm with thick edge

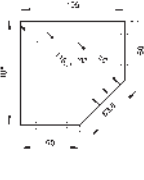


		Order no. W H D	Hinge side:	Carcase depth	Decor groups						
					AP	AP D	AP 5D	AP 16D	AP 16R	AP 25D	AP 25R
	<b>Worktop corner connection, 135°</b> with tongue and groove and 2 tightening fittings (length for mitre added at the factory free of charge).	Unit price <b>AP-V 135</b>			37	37	-	-	-	37	37
	<b>Worktop corner connection with special abutment joint</b> with tongue and groove and 2 tightening fittings	Unit price <b>AP-V 00</b>			143	143	-	-	-	143	143
	<b>Worktop corner connection, 45°</b> with tongue and groove and 3 tightening fittings	Unit price <b>AP-G 45</b>			54	54	-	-	-	54	54
	<b>Worktop corner connection with special mitre</b> with tongue and groove and 2 tightening fittings	Unit price <b>AP-G 00</b>			117	117	-	-	-	117	117
	<b>Corner worktop 90 x 90 cm</b> Front edge with thick edge 60 cm deep 90 cm deep 106.1 cm deep	Unit price <b>APD E 90 60</b> Unit price <b>APD E 90 90</b> Unit price <b>APD E 90 VT</b>			-	233	-	-	-	-	-
	<b>Corner worktop 92 x 60 cm</b> Front edge with thick edge with 22.5° mitre on left and right side and tongue and groove with tightening screw 60 cm deep 90 cm deep 106.1 cm deep	Unit price <b>APD E 92 60</b> Unit price <b>APD E 92 90</b> Unit price <b>APD E 92 VT</b>			-	233	-	-	-	-	-
	<b>Corner worktop 105 x 105 cm</b> Front edge with thick edge 60 cm deep 90 cm deep 116.7 cm deep	Unit price <b>APD E 105 60</b> Unit price <b>APD E 105 90</b> Unit price <b>APD E 105 VT</b>			-	233	-	-	-	-	-
	<b>Corner worktop 113 x 60 cm</b> Front edge with thick edge with 22.5° mitre on left and right side and tongue and groove with tightening screw 60 cm deep 90 cm deep 116.7 cm deep	Unit price <b>APD E 113 60</b> Unit price <b>APD E 113 90</b> Unit price <b>APD E 113 VT</b>			-	233	-	-	-	-	-
	<b>Worktop gallery, Front edge with thick edge</b> 8.5 cm high, for corner worktop 90 x 90 cm (51 x 51 cm)	Unit price <b>ADE 90</b>			-	165	-	-	-	-	-
	<b>Worktop gallery, Front edge with thick edge</b> 8.5 cm high, for corner worktop 105 x 105 cm (69 x 69 cm)	Unit price <b>ADE 105</b>			-	165	-	-	-	-	-





# Worktops 48 mm

		Order no.	Decor groups							
			W	H	D	AP	AP D	AP 5D	AP 16D	AP 16R
 <p><b>Worktop</b> Front edge with thick edge, 1.5 mm Approx. 48 mm thick Laminate surface</p>	up to 60 cm depth	 AP5D max. length 510 cm								
	up to 63 cm depth		per 10 cm Width <b>AP 5 D60</b>	-	-	19,50	-	-	-	-
	up to 65 cm depth		per 10 cm Width <b>AP 5 D63</b>	-	-	30	-	-	-	-
	from 61 - 90 cm depth		per 10 cm Width <b>AP 5 D65</b>	-	-	30	-	-	-	-
	from 91 - 118 cm depth		per 10 cm Width <b>AP 5 D90</b>	-	-	30	-	-	-	-
			per 10 cm Width <b>AP 5 D118</b>	-	-	37	-	-	-	-
Worktop decor 48 mm	2650 Natural sandstone effect	5573 Classic Oak								
AP5D Laminate 48 mm/Thick Edge	2701 snow white spatula look effect	5579 Brown concrete effect								
1180 natural mountain oak	3157 Piemont Oak	6290 Ferro black gold								
1200 Roxano volcano black	3797 Mocca	6307 Natural onyx effect								
1210 Metal Rock anthracite	4262 Castell Oak	8000 Crystal marble								
1369 Dark Maron effect	4268 natural Green Ceramic	9200 Cupria marble								
1385 Royal Oak effect	4326 Elegant walnut effect	9386 Seal Oak effect								
2032 Wild Oak	4374 Concrete effect opal	9612 Graphite Black stone look								
2240 Diamond oak effect	4375 Concrete effect pearl grey	9630 Art Pepper stone look								
2260 Sand beige titanite	4440 graphite concrete effect									
2406 Mountain Wood	5411 Mammoth oak natural									
 <p><b>Extra charge for edging</b> of the worktops at rear and side thick edge (side without charge)</p>	per 10 cm Width									
	<b>AP 5 D-K00MH</b>	-	-	5,30	-	-	-	-		
 <p><b>Worktop angled cut with thick edge at the end of a row</b> with return (rounded corners R=25 mm)</p>	Unit price									
	<b>AP 5 D-S03</b>	-	-	131	-	-	-	-		
 <p><b>Worktop 90° angled cutout at the end of a row</b> with return, only possible WITHOUT inside radius with thick edge (min. 10 cm deep, maximum cutout length 350 cm) (square cutout cannot be combined with rounded cutout or corners)</p>	per 10 cm Width									
	<b>AP 5 D-WE90</b>	-	-	25	-	-	-	-		
 <p><b>Worktop corner connection, 90°</b> with tongue and groove and 2 tightening fittings (length for mitre added at the factory free of charge).</p>	Unit price									
	<b>AP 5-V90</b>	-	-	73	-	-	-	-		
 <p><b>Worktop corner connection, 135°</b> with tongue and groove and 2 tightening fittings (length for mitre added at the factory free of charge).</p>	Unit price									
	<b>AP5-V135</b>	-	-	73	-	-	-	-		
 <p><b>Worktop corner connection with special abutment joint</b> with tongue and groove and 2 tightening fittings</p>	Unit price									
	<b>AP 5-V00</b>	-	-	143	-	-	-	-		
 <p><b>Worktop corner connection, 45°</b> with tongue and groove and 3 tightening fittings</p>	Unit price									
	<b>AP 5-G45</b>	-	-	117	-	-	-	-		
<p><b>Worktop corner connection with special mitre</b> with tongue and groove and 2 tightening fittings</p>	Unit price									
	<b>AP 5-G00</b>	-	-	117	-	-	-	-		
 <p><b>Corner worktop 90 x 90 cm</b> Front edge with thick edge</p>	60 cm deep	Unit price								
		<b>AP 5 DE9060</b>	-	-	373	-	-	-		
	90 cm deep	Unit price								
		<b>AP 5 DE9090</b>	-	-	576	-	-	-		
106.1 cm deep	Unit price									
	<b>AP 5 DE90VT</b>	-	-	701	-	-	-			
 <p><b>Corner worktop 92 x 60 cm</b> Front edge with thick edge with 22.5° mitre on left and right side and tongue and groove with tightening screw</p>	60 cm deep	Unit price								
		<b>AP 5 DE9260</b>	-	-	373	-	-	-		
	90 cm deep	Unit price								
		<b>AP 5 DE9290</b>	-	-	576	-	-	-		
106.1 cm deep	Unit price									
	<b>AP 5 DE92VT</b>	-	-	701	-	-	-			

# Worktops 48 mm

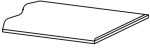
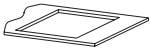
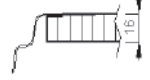


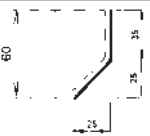
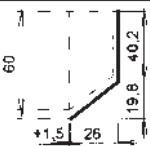
		Order no. W H D	Hinge side:	Carcase depth	Decor groups										
					AP	AP D	AP 5D	AP 16D	AP 16R	AP 25D	AP 25R				
 <p><b>Corner worktop 105 x 105 cm</b> Front edge with thick edge 60 cm deep 90 cm deep 116.7 cm deep</p>		Unit price													
		<b>AP 5 DE10560</b>	-	-	373	-	-	-	-	-	-	-	-	-	
		Unit price													
		<b>AP 5 DE10590</b>	-	-	576	-	-	-	-	-	-	-	-	-	
 <p><b>Corner worktop 113 x 60 cm</b> Front edge with thick edge with 22.5° mitre on left and right side and tongue and groove with tightening screw 60 cm deep 90 cm deep 116.7 cm deep</p>		Unit price													
		<b>AP 5 DE11360</b>	-	-	373	-	-	-	-	-	-	-	-	-	
		Unit price													
		<b>AP 5 DE11390</b>	-	-	576	-	-	-	-	-	-	-	-	-	
<p><b>Laminate (all decors)</b> <b>max. 270 x 125 cm</b> approx. 0.8 mm thick minimum price, apart from FENIX colours</p>		pro m <sup>2</sup> , B x D													
		<b>Z 32</b>	78	78	78	78	110	78	110						
		<b>minimum price</b>	37	37	37	37	52	37	52						
		 <b>Important!</b> 1st dimension = direction of grain. <b>Not available for:</b> FENIX decors													

# Slim-line worktops 16 mm



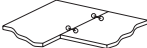

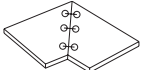
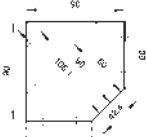

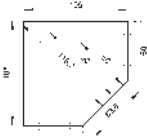


Order no. W H D	Hinge side: Carcase depth	Decor groups						
		AP	AP D	AP 5D	AP 16D	AP 16R	AP 25D	AP 25R
 <p><b>Worktop</b> Front edge with thick edge, 1.5 mm approx. 17 mm thick Laminate surface</p> <p>up to 60 cm depth</p> <p>up to 63 cm depth</p> <p>up to 65 cm depth</p> <p>from 61 - 90 cm depth</p> <p>from 91 - 120 cm depth</p>	<p> AP 16D max. length 360 cm AP 16R max. length 360 cm</p>							
	per 10 cm Width <b>AP 16 D60</b>	-	-	-	18,80	25,90	-	-
	per 10 cm Width <b>AP 16 D63</b>	-	-	-	31	42	-	-
	per 10 cm Width <b>AP 16 D 65</b>	-	-	-	31	42	-	-
	per 10 cm Width <b>AP 16 D90</b>	-	-	-	31	42	-	-
per 10 cm Width <b>AP 16 D120</b>	-	-	-	32	45	-	-	
AP16D Laminate Slim-line 16 mm	5579 Brown concrete effect	AP16R RESOPAL PRO 16 mm/thick edge	9600 Nature Powder super matt					
1070 Bordeaux oak	6290 Ferro black gold	1640 Jura Grey super matt	9950 Titanium grey super matt					
1200 Roxano volcano black		1880 cool white super matt						
2650 <b>Natural sandstone effect</b>		2111 Moonlight Green super matt						
3797 Mocca		3170 Macaron Powder super matt						
4262 Castell Oak		5360 Dark Powder super matt						
4374 Concrete effect opal		5380 Light Powder super matt						
4375 Concrete effect pearl grey		5460 Brown Powder super matt						
4440 graphite concrete effect		6300 Anthracite super matt						
5411 Mammoth oak natural		9015 Black super matt						
5573 Classic Oak		9410 Premium white super matt						

## Planning advice in conjunction with dishwasher with worktop thickness 16 mm:

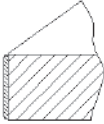


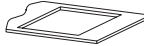
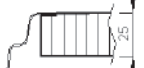




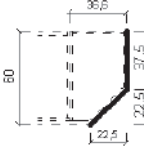
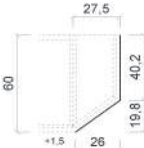
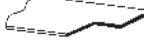

Attachment rails are necessary for all sinks and hobs. These are 25 mm high. This means that XL dishwashers cannot be planned below the sink drain unit, because the worktop sits directly above.

 <p><b>Extra charge for edging</b> of the worktops at rear</p>	per 10 cm Width <b>AP 16 D-KH</b>	-	-	-	3,40	3,40	-	-
 <p><b>Worktop cutout</b> For hobs, sinks, ventilation grilles, etc.</p>	Unit price <b>AP 16 D-A00</b>	-	-	-	33	33	-	-
<p><b>Waterproof cutout for flush-fitted built-in sinks</b> With cast resin, without installation Inside radius: 10-20 mm</p>	<b>AP 16 D-AW</b>	-	-	-	394	394	-	-
 <p><b>Cutout for flush-fitted built-in sinks</b> with casting resin, without installation, not possible for square sinks minimum radius R = 5mm Only possible for stainless steel built-in sinks</p>	Unit price <b>AP 16 D-AS</b>	-	-	-	394	394	-	-
 <p><b>Cutout for flush-fitted hobs</b> with cast resin, without installation, not possible for square hobs minimum radius R = 5mm Hobs may not be placed on silicone, but may only be sealed using silicone.</p>	Unit price <b>AP 16 D-AK</b>	-	-	-	394	394	-	-
<p><b>Water-tight drill holes</b> for e.g. mixer taps, installation on site mixer taps are not part of the delivery Up to 35 mm diameter</p>	Unit price <b>AP 16 D-BO</b>	-	-	-	78	78	-	-
 <p><b>Worktop angled cut at the end of a row</b> with return Variable, with thick edge (rounded corners R=20 mm)</p>	Unit price <b>AP 16 D-S01</b>	-	-	-	95	95	-	-
 <p><b>Worktop angled cut at the end of row 45°</b> for base shelf end units 25 cm and 34 cm wide (models URA 25.. and URA 34..), with thick edge (rounded corners R=20 mm) worktop overhang 4.5 cm</p>	Unit price <b>AP 16 D-S45</b>	-	-	-	95	95	-	-
 <p><b>Worktop angled cut at the end of row 37.2°</b> For base units, angled, 25 cm wide (US 25..) with thick edge, worktop overhang 2.5 cm (rounded corners R=20 mm)</p>	Unit price <b>AP 16 D-S37</b>	-	-	-	95	95	-	-

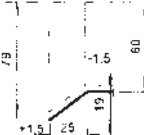






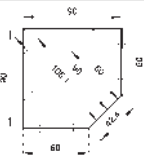
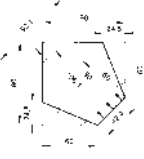
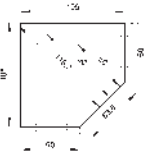
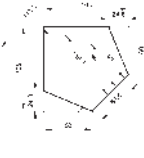
# Slim-line worktops 16 mm

	Order no. W H D	Unit price	Decor groups										
			Hinge side:	Carcase depth	AP	AP D	AP 5D	AP 16D	AP 16R	AP 25D	AP 25R		
 <b>Worktop 90° angled cutout at the end of a row with return</b> With thick edge (available only with inside radius R = 40 mm) (min. 10 cm deep)		Unit price <b>AP 16 D-W91</b>			-	-	-	95	95	-	-		
<b>Worktop 90° angled cutout at the end of a row WITHOUT inside radius, square</b> minimum size 5 x 5 cm, maximum cutout length 350 cm (square cutout cannot be combined with rounded cutout or corners)		Unit price <b>AP 16 D-WE90</b>			-	-	-	346	346	-	-		
 <b>Worktop rounding for Worktops with thick edge</b> Standard roundings at front, 25 mm radius min. R 20 mm		Unit price <b>AP 16 D-R</b>			-	-	-	95	95	-	-		
 <b>Worktop corner connection, 90°</b> with tongue and groove and 2 tightening fittings (length for mitre added at the factory free of charge).		Unit price <b>AP 16 D-V90</b>			-	-	-	54	54	-	-		
 <b>Worktop corner connection, 135°</b> with tongue and groove and 2 tightening fittings (length for mitre added at the factory free of charge).		Unit price <b>AP 16 D-V135</b>			-	-	-	54	54	-	-		
<b>Worktop corner connection with special abutment joint</b> with tongue and groove and 2 tightening fittings		Unit price <b>AP 16 D-V00</b>			-	-	-	143	143	-	-		
 <b>Worktop corner connection, 45°</b> with tongue and groove and 3 tightening fittings		Unit price <b>AP 16 D-G45</b>			-	-	-	54	54	-	-		
<b>Worktop corner connection with special mitre</b> with tongue and groove and 2 tightening fittings		Unit price <b>AP 16 D-G00</b>			-	-	-	117	117	-	-		
 <b>Corner worktop 90 x 90 cm</b> Front edge with thick edge 106.1 cm deep		Unit price <b>AP 16 DE90VT</b>			-	-	-	547	755	-	-		
 <b>Corner worktop 92 x 60 cm</b> Front edge with thick edge with 22.5° mitre on left and right side and tongue and groove with tightening screw 106.1 cm deep		Unit price <b>AP 16 DE92VT</b>			-	-	-	547	755	-	-		
 <b>Corner worktop 105 x 105 cm</b> Front edge with thick edge 60 cm deep 90 cm deep 116.7 cm deep		Unit price <b>AP 16 DE10560</b>			-	-	-	320	441	-	-		
		Unit price <b>AP 16 DE10590</b>			-	-	-	492	678	-	-		
		Unit price <b>AP 16 DE105VT</b>			-	-	-	587	811	-	-		
<b>Must be planned:</b> <b>Installation set for hobs and sinks for worktops 16 mm thick</b> 1 set comprising 3 mounting strips incl. fixing material for hobs and sinks 60 cm		Unit price <b>ES 16 60</b>								55			
 <b>Metal cross-bars for base units</b> silver-coloured Supports for worktops 1.6 cm		<b>MTA 80</b>										19.50	
		<b>MTA 90</b>										21.40	
		<b>MTA 100</b>										23	
		<b>MTA 120</b>										25	
 <b>Planning: Additional requirement.</b> 1 cross member for carcase depths 45.5 cm/55.5 cm 2 cross members for carcase depths 70.5 cm. Profile cross section 20/25mm													

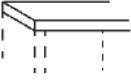
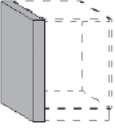

# Worktops 25 mm

		Order no. W H D	Hinge side: Carcass depth	Decor groups							
				AP	AP D	AP 5D	AP 16D	AP 16R	AP 25D	AP 25R	
 <p><b>Worktop</b> Front edge with thick edge, 1.5 mm Laminate surface</p> <p>up to 60 cm depth up to 63 cm depth up to 65 cm depth from 61 - 90 cm depth from 91 - 120 cm depth</p>	<p> AP 25D max. length 510 cm AP 25R max. length 360 cm</p>										
	per 10 cm Width										
	<b>AP 25 D60</b>				-	-	-	-	11,60 16		
	<b>AP 25 D63</b>				-	-	-	-	18,70 25,80		
	<b>AP 25 D65</b>				-	-	-	-	18,70 25,80		
	<b>AP 25 D90</b>				-	-	-	-	18,70 25,80		
<b>AP 25 D120</b>				-	-	-	-	23,30 32			
<p>AP25D Laminate 25 mm/thick edge</p> <p>1180 natural mountain oak 1369 Dark Maron effect 1385 Royal Oak effect 2240 Diamond oak effect 2406 Mountain Wood 2650 Natural sandstone effect 3157 Piemont Oak 4262 Castell Oak 4268 natural Green Ceramic 4326 Elegant walnut effect</p>	<p>4374 Concrete effect opal 4375 Concrete effect pearl grey 4440 graphite concrete effect 5411 Mammoth oak natural 5573 Classic Oak 5579 Brown concrete effect 6290 Ferro black gold 6307 Natural onyx effect 8000 Crystal marble 9200 Cupria marble</p>	<p>AP25R RESOPAL PRO 25 mm/thick edge</p> <p>1640 Jura Grey super matt 1880 cool white super matt 2111 Moonlight Green super matt 3170 Macaron Powder super matt 5360 Dark Powder super matt 5380 Light Powder super matt 5460 Brown Powder super matt 6300 Anthracite super matt 9015 Black super matt 9410 Premium white super matt</p>	<p>9600 Nature Powder super matt 9950 Titanium grey super matt</p>								
 <p><b>Extra charge for edging</b> of the worktops at rear and side thick edge (side without charge)</p>		per 10 cm Width									
		<b>APD-K 00</b>			3,40	3,40	-	-	-	3,40	3,40
 <p><b>Worktop cutout</b> For hobs, sinks, ventilation grilles, etc.</p>	<b>NEW</b>	Unit price									
		<b>AP 25 D-A00</b>			-	-	-	-	-	33	33
 <p><b>Cutout for flush-fitted built-in sinks</b> with casting resin, without installation, not possible for square sinks minimum radius R = 5mm</p>		Unit price									
	<b>AP 25 D-AS</b>			-	-	-	-	-	-	394	
<p> <b>Planning advice:</b> Minimum distance to side edge of the worktop 5 cm <b>Must be included:</b> Installation sketch with precise dimension information, article no. of the built-in sink Sink to be installed on site, sink is not part of the delivery</p>											
 <p><b>Cutout for flush-fitted hobs</b> with cast resin, without installation, not possible for square hobs minimum radius R = 5mm Hobs may not be placed on silicone, but may only be sealed using silicone.</p>		Unit price									
	<b>AP 25 D-AK</b>			-	-	-	-	-	-	394	
<p> <b>Planning advice:</b> Minimum distance to side edge of the worktop 5 cm <b>Must be included:</b> Installation sketch with precise dimension information, article no. of the electrical appliances Hob to be installed on site, hob is not part of the delivery.</p>											
<p><b>Water-tight drill holes</b> for e.g. mixer taps, installation on site mixer taps are not part of the delivery Up to 35 mm diameter</p>		Unit price									
	<b>AP 25 D-BO</b>			-	-	-	-	-	-	78	
 <p><b>Worktop angled cut at the end of a row</b> with return variable, with thick edge (rounded corners R=25 mm)</p>		Unit price									
	<b>APD-S 01</b>			-	75	-	-	-	75	75	
 <p><b>Worktop angled cut at the end of row 45°</b> for base shelf end units 25 cm and 34 cm wide (models URA 25.. and URA 34..), with thick edge worktop overhang 4.5 cm (rounded corners R=25 mm)</p>		Unit price									
	<b>APD-S 45</b>			-	63	-	-	-	63	63	
 <p><b>Worktop angled cut at the end of row 37.2°</b> For base units, angled, 25 cm wide (US 25..) with thick edge, worktop overhang 2.5 cm (rounded corners R=25 mm)</p>		Unit price									
	<b>APD-S 37</b>			-	63	-	-	-	63	63	
 <p><b>Worktop 90° angled cutout at the end of a row</b> with return with thick edge (only available with inside radius R = 65 mm) (min. 10 cm deep)</p>		per 10 cm Width									
	<b>APD-W91</b>			-	7,50	-	-	-	7,50	7,50	
 <p><b>Worktop 90° angled cutout at the end of a row</b> <b>WITHOUT</b> inside radius, square with return (min. 10 cm deep) minimum size 5 x 5 cm, maximum cutout length 350 cm (square cutout cannot be combined with rounded cutout or corners)</p>		per 10 cm Width									
	<b>APD-WE90</b>			-	25	-	-	-	25	25	

# Worktops 25 mm

	Order no. W H D	Hinge side: Carcase depth	Decor groups						
			AP	AP D	AP 5D	AP 16D	AP 16R	AP 25D	AP 25R
 <p><b>Worktop angled cutout in the middle of row</b> For US 25.. with thick edge (calculate angle with 40 cm)</p>	per 10 cm Width <b>APD-W37</b>		-	7,50	-	-	-	7,50	7,50
 <p><b>Worktop rounding for Worktops with thick edge</b> Standard roundings at front, 25 mm radius instead of straight side edges left and right are included in the worktop price (model APD)</p>	Unit price <b>APD-R 00</b>		-	109	-	-	-	109	109
 <p><b>Worktop corner connection, 90°</b> with tongue and groove and 2 tightening fittings (length for mitre added at the factory free of charge).</p>	Unit price <b>AP-V 90</b>		37	37	-	-	-	37	37
 <p><b>Worktop corner connection, 135°</b> with tongue and groove and 2 tightening fittings (length for mitre added at the factory free of charge).</p>	Unit price <b>AP-V 135</b>		37	37	-	-	-	37	37
 <p><b>Worktop corner connection with special abutment joint</b> with tongue and groove and 2 tightening fittings</p>	Unit price <b>AP-V 00</b>		143	143	-	-	-	143	143
 <p><b>Worktop corner connection, 45°</b> with tongue and groove and 3 tightening fittings</p>	Unit price <b>AP-G 45</b>		54	54	-	-	-	54	54
 <p><b>Worktop corner connection with special mitre</b> with tongue and groove and 2 tightening fittings</p>	Unit price <b>AP-G 00</b>		117	117	-	-	-	117	117
 <p><b>Corner worktop 90 x 90 cm</b> Front edge with thick edge 106.1 cm deep 60 cm deep 90 cm deep 106.1 cm deep</p>	Unit price <b>AP25D E 9060</b> <b>AP25D E 9090</b> <b>AP25D E 90VT</b>		-	-	-	-	-	233	322
 <p><b>Corner worktop 92 x 60 cm</b> Front edge with thick edge with 22.5° mitre on left and right side and tongue and groove with tightening screw 106.1 cm deep 60 cm deep 90 cm deep 106.1 cm deep</p>	Unit price <b>AP25D E 9260</b> <b>AP25D E 9290</b> <b>AP25D E 92VT</b>		-	-	-	-	-	233	322
 <p><b>Corner worktop 105 x 105 cm</b> Front edge with thick edge 60 cm deep 90 cm deep 116.7 cm deep</p>	Unit price <b>AP 25 DE10560</b> <b>AP 25 DE10590</b> <b>AP 25 DE105VT</b>		-	-	-	-	-	233	322
 <p><b>Corner worktop 113 x 60 cm</b> Front edge with thick edge with 22.5° mitre on left and right side and tongue and groove with tightening screw 60 cm deep 90 cm deep 116.7 cm deep</p>	Unit price <b>AP25D E 113 60</b> <b>AP25D E 113 90</b> <b>AP25D E 113 VT</b>		-	-	-	-	-	233	322

# Bar tops 100 mm

		Order no. W H D		Hinge side:	Carcase depth	Decor groups		
						TP 10D	TP 10R	
 <p><b>Bar top</b> in worktop decors coated on both sides Laminate edge on all sides 100 mm thick maximum depth: 120 cm maximum length: 360 cm minimum depth: 40 cm minimum length: 30 cm</p> <p>from 40 - 60 cm depth from 61 - 90 cm depth from 91 - 120 cm depth</p>			per 10 cm Width					
			<b>TPL 100 60</b>	73	88			
			<b>TPL 100 90</b>	93	112			
			<b>TPL 100 120</b>	117	140			
 <p><b>Bar top</b> in worktop decors coated on both sides Laminate edge on all sides Height adjustment via 2 adjustment feet 100 mm thick maximum depth: 120 cm maximum height: 360 cm minimum depth: 40 cm minimum height: 30 cm</p> <p>from 40 - 60 cm depth from 61 - 90 cm depth from 91 - 120 cm depth</p>			per 10 cm Height					
			<b>STPL 100 60</b>	77	93			
			<b>STPL 100 90</b>	98	118			
			<b>STPL 100 120</b>	121	145			
 <p><b>Worktop angled cut</b> min 50 x 50 mm</p>			<b>TPL-S01</b>	192				

**TP10D Bar top 100 mm**

- 1070 Bordeaux oak
- 1200 Roxano volcano black
- 2650 **Natural sandstone effect**
- 3797 Mocca
- 4262 Castell Oak
- 4374 Concrete effect opal
- 4375 Concrete effect pearl grey
- 4440 graphite concrete effect
- 5411 Mammoth oak natural
- 5573 Classic Oak
- 6290 Ferro black gold

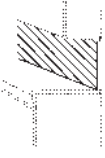



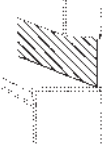

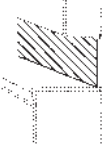





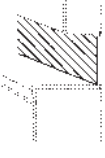




**TP10R Bar top 100 mm/RESOPAL**

- 1640 Jura Grey super matt
- 1880 cool white super matt
- 2111 Moonlight Green super matt
- 3170 Macaron Powder super matt
- 5360 Dark Powder super matt
- 5380 Light Powder super matt
- 5460 Brown Powder super matt
- 6300 Anthracite super matt
- 9015 Black super matt
- 9410 Premium white super matt
- 9600 Nature Powder super matt
- 9950 Titanium grey super matt



# Recess back panels

## Decor groups

	Order no. W H D	Decor groups												
		M10	M20	M30	M50	M60	M80	M90	G	N1	N2	N3		
 <p><b>Recess back panel accessory decor</b> Height 48 cm, approx. 16 mm thick With edging finish</p>	per 10 cm Width													
	<p><b>NRW48</b></p> <p><b>minimum price</b></p> <p> <b>Note:</b> Minimum spacings for Q and Q4 hobs: 50 mm for induction, glass and cast iron 200 mm for gas hobs</p>	4,20	6,90	11,70	22	22	33	8,40	-	-	-	-	-	-
 <p><b>Recess back panel SMARTGLAS Slim panel</b> height 48 cm Surface: polymeric glass single cut edge, without edge finishing</p> <p><b>Cannot be processed</b></p>	per 10 cm Width													
	<p><b>NRW48-4</b></p> <p><b>minimum price</b></p> <p> <b>Note:</b> maximum length 2780 cm Thickness of high-gloss version 4.2 mm Thickness of satin-finish version 3.7 mm Minimum spacings for Q and Q4 hobs: 50 mm for induction, glass and cast iron 200 mm for gas hobs</p>	-	-	-	-	12,50	-	-	-	-	-	-	-	-
 <p><b>Recess back panel accessory decor</b> Height 54.5 cm, approx. 16 mm thick With edging finish for carcass heights 71.5 cm and 84.5 cm</p>	per 10 cm Width													
	<p><b>NRW54</b></p> <p><b>minimum price</b></p> <p> <b>Note:</b> Minimum spacings for Q and Q4 hobs: 50 mm for induction, glass and cast iron 200 mm for gas hobs</p>	4,20	6,90	11,70	22	22	33	8,40	-	-	-	-	-	
 <p><b>Recess back panel SMARTGLAS Slim panel</b> height 54.5 cm Surface: polymeric glass single cut edge, without edge finishing</p> <p><b>Cannot be processed</b></p>	per 10 cm Width													
	<p><b>NRW54-4</b></p> <p><b>minimum price</b></p> <p> <b>Note:</b> maximum length 2780 cm Thickness of high-gloss version 4.2 mm Thickness of satin-finish version 3.7 mm Minimum spacings for Q and Q4 hobs: 50 mm for induction, glass and cast iron 200 mm for gas hobs</p>	-	-	-	-	14,30	-	-	-	-	-	-	-	
 <p><b>Recess back panel Variable versions with edging finish,</b> Max. dimensions see section 2</p>	per m <sup>2</sup> , W x H													
	<p><b>NRWMK</b></p> <p><b>minimum price</b></p> <p> <b>Important!</b> minimum height 7 cm Minimum spacings for Q and Q4 hobs: 50 mm for induction, glass and cast iron 200 mm for gas hobs</p>	84	143	324	432	432	695	171	-	-	-	-	-	
 <p><b>Recess back panel Variable versions without edging finish,</b> Max. dimensions see section 2</p>	per m <sup>2</sup> , W x H													
	<p><b>NRWOK</b></p> <p><b>minimum price</b></p> <p> <b>Important!</b> minimum height 7 cm</p>	78	139	264	-	-	-	139	-	-	-	-	-	
 <p><b>Recess back panel SMARTGLAS Slim panel Variable versions</b> Surface: polymeric glass single cut edge, without edge finishing</p> <p><b>Cannot be processed</b></p>	per m <sup>2</sup> , W x H													
	<p><b>NRWOK-4</b></p> <p><b>minimum price</b></p> <p> <b>Important!</b> minimum height 7 cm maximum dimensions 2780 x 1250 mm Thickness of high-gloss version 4.2 mm Thickness of satin-finish version 3.7 mm Minimum spacings for Q and Q4 hobs: 50 mm for induction, glass and cast iron 200 mm for gas hobs</p>	-	-	-	-	262	-	-	-	-	-	-	-	
 <p><b>Angled cut with edge</b></p>	Unit price													
	<b>W-A</b>	53												
 <p><b>Rounding with edge</b> 16mm: min outer radius = 40mm</p> <p>19mm: min outer radius = 40mm</p> <p>25mm: min outer radius = 25mm</p>	Unit price													
	<b>W-R</b>	109												
 <p><b>Corner cutout with edge</b> (min. 10 cm deep) 16mm: min inside radius = 30mm</p> <p>19mm: min inside radius = 30mm</p> <p>25mm: min inside radius = 65mm</p>	Unit price													
	<b>W-W</b>	109												

# Recess back panels

## Decor groups

Order no.  
W H D

M10 M20 M30 M50 M60 M80 M90 G N1 N2 N3

Corner cutout with  
thin edge, 90° square

per 10 cm Width

W-WE 90

25



**Important!**  
Minimum size 5 x 5 cm

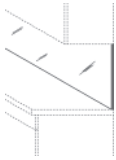
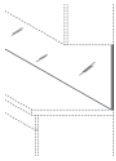

M 10	M 20	M 30	M 50	M 60
<p><b>K M10 laminate</b></p> <p>K005S Castelli Oak K006P Light Grey K023P Stainless Steel Colour K039G Premium white glossy K039P Premium white K043P Graphite Black K058P Magic-grey K075P Black K076P Macaron K160F Snow White K160G Snow White Gloss K178F White Agate K190S Mammoth oak natural K199S Piemont Oak K216S natural mountain oak K218P Light Pepper K229S Classic Oak K230P Art Pepper K235P Titan Steel K236S Diamond Oak effect K247S Dark Maron effect K248P Light Nude K262S Royal Oak effect K263P Fango K269S Mountain Wood K270S Elegant walnut effect</p>	<p><b>D M20 Laminate decor</b></p> <p>D147S Burnt Wood D149W Brown concrete effect D187W Concrete effect opal D188W Concrete effect pearl grey D212W graphite concrete effect D224S Bordeaux oak D250S Black Oak effect D251S Seal Oak effect D264S Light oak, grooved look D265S Dark oak, grooved look D271W Natural sandstone effect D272F Jade pastel</p>	<p><b>I M30 RESOPAL PRO super matt</b></p> <p>I039M Premium white I075M Black I076M Macaron powder I138M Titanium grey I139M Jura Grey I140M anthracite I141M cool white I240M Light Powder I241M Dark Powder I253M Moonlight Green I267M brown powder I268M nature powder</p> <p><b>IH M30 HPL PRO</b></p> <p>I273H Natural onyx effect I274H Navyblue I280H Smoke Powder I281H Ferro black gold</p>	<p><b>S M50 microstructure lacquer</b></p> <p>S006P Light Grey S039P Premium white S043P Graphite Black S058P Magic-grey S075P Black S076P Macaron S099P special colour S160P Snow White S178P White Agate S218P Light Pepper S230P Art Pepper S245P Night Green S248P Light Nude S263P Fango</p> <p><b>B M50 Velvet lacquer</b></p> <p>B006F Light Grey B039F Premium white B043F Graphite Black B058F Magic-grey B075F Black B076F Macaron B099F special colour B160F Snow White B178F White Agate B218F Light Pepper B230F Art Pepper B245F Night Green B248F Light Nude B263F Fango</p>	<p><b>QH M60 SMARTGLAS high-gloss</b></p> <p>Q075H Black Q160H Snow White Q178H White Agate Q191H Sand grey Q200H Carrara white Q201H Cream</p> <p><b>Q4H M60 SMARTGLAS high-gloss, 4 mm</b></p> <p>Q075H Black Q160H Snow White Q178H White Agate Q191H Sand grey Q200H Carrara white Q201H Cream</p>
M 60	M 80	M 80	M 90	
<p><b>QM M60 SMARTGLAS satin-finish</b></p> <p>Q075M Black Q160M Snow White Q178M White Agate Q191M Sand grey Q192M Taupe Q200M Carrara white Q201M Cream Q234M Carbon metallic satin-finish Q244M Aqua Q254M Black metallic Q255M Champagne metallic Q256M Grey metallic Q277M Silk Metallic Q278M Bronze Metallic</p> <p><b>Q4M M60 SMARTGLAS satin-finish, 4mm</b></p> <p>Q075M Black Q160M Snow White Q178M White Agate Q191M Sand grey Q192M Taupe Q200M Carrara white Q201M Cream Q234M Carbon metallic satin-finish Q244M Aqua Q254M Black metallic Q255M Champagne metallic Q256M Grey metallic Q277M Silk Metallic Q278M Bronze Metallic</p>	<p><b>C1 M80 FENIX stainless-steel look super matt</b></p> <p>C023M Stainless Steel Look</p> <p><b>H M80 high gloss-Lacquer</b></p> <p>H006H Light Grey H039H Premium white H043H Graphite Black H058H Magic-grey H075H Black H076H Macaron H099H special colour H160H Snow White H178H White Agate H218H Light Pepper H230H Art Pepper H245H Night Green H248H Light Nude H263H Fango</p>	<p><b>MP M80 laqué mat Premium</b></p> <p>MP006 Light Grey MP039 Premium white MP043 Graphite Black MP058 Magic-grey MP075 Black MP076 Macaron MP099 special colour MP160 Snow White MP178 White Agate MP218 Light Pepper MP230 Art Pepper MP245 Night Green MP248 Light Nude MP263 Fango</p>	<p><b>A1 M90 Worktop decor on both sides</b></p> <p>1200 Roxano volcano black 1210 Metal Rock anthracite 2032 Wild Oak 2260 Sand beige titanite 2701 snow white spatula look effect 3797 Mocca 4268 natural Green Ceramic 8000 Crystal marble 9200 Cupria marble 9612 Graphite Black stone look 9630 Art Pepper stone look</p>	

# Glass recess back panels

Please observe a minimum distance of 100 mm between the outer edge of a gas hob and a glass recess back panel in order to avoid damage to the glass recess back panel.

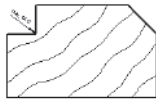
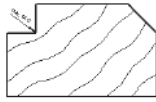

Order no.  
W H D

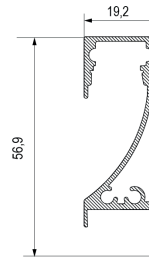
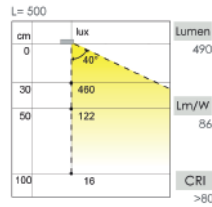
## Decor groups

		M10	M20	M30	M50	M60	M80	M90	G	N1	N2	N3
	<b>Glass recess back panel</b> Glass panel (safety glass) approx. 4 mm thick on substrate Total thickness approx. 16 mm	per m <sup>2</sup> , W x H										
	<b>NRWG</b>	-	-	-	-	-	-	-	409	-	-	-
<b>minimum price</b>		-	-	-	-	-	-	-	201	-	-	-
	<b>Glass recess back panel</b> <b>Support panel, loose</b> Total thickness approx. 16 mm	per m <sup>2</sup> , W x H										
	<b>NRWGL</b>	-	-	-	-	-	-	-	409	-	-	-
<b>minimum price</b>		-	-	-	-	-	-	-	201	-	-	-
 For reasons of transport safety, the substrate is supplied separately.												

- Glass type**  
**G safety glass**
- 82 red glass
  - 83 white glass
  - 84 Macaron glass
  - 921 white agate glass
  - 960 snow white glass
  - 97 black glass
  - 990 grey glass

Processing information for glass recess back panels  
We cannot deliver the item without the exact dimensional drawing.  
Drill holes spaced at least 5 mm from edge

	<b>Angled cut</b> for glass recess back panels	Unit price											
	<b>NRWG-A</b>	-	-	-	-	-	-	-	84	-	-	-	
	<b>Angled cutout</b> for glass recess back panels	Unit price											
	<b>NRWG-W</b>	-	-	-	-	-	-	-	84	-	-	-	
 <b>Note: Angled cutout min. R = 10 mm</b>													
	<b>Drill hole</b> <b>diameter 5-50 mm</b>	Unit price											
	<b>NRWG-L</b>	-	-	-	-	-	-	-	71	71	71	71	
	<b>Drill hole</b> <b>diameter 51-100 mm</b>	Unit price											
	<b>NRWG-L51</b>	-	-	-	-	-	-	-	207	207	207	207	
	<b>Drill hole for</b> <b>single socket 68 mm dia.</b>	Unit price											
	<b>NRWG-S1</b>	-	-	-	-	-	-	-	42	42	42	42	
	<b>Drill hole for</b> <b>double socket 68 x 139 mm dia.</b>	Unit price											
	<b>NRWG-S2</b>	-	-	-	-	-	-	-	58	58	58	58	
	<b>Drill hole for</b> <b>triple socket 68 x 210 mm dia.</b>	Unit price											
	<b>NRWG-S3</b>	-	-	-	-	-	-	-	71	71	71	71	
	<b>Drill hole for</b> <b>quadruple socket 68 x 281 mm dia.</b>	Unit price											
	<b>NRWG-S4</b>	-	-	-	-	-	-	-	86	86	86	86	
	<b>Drill hole for</b> <b>quintuple socket 68 x 352 mm dia.</b>	Unit price											
	<b>NRWG-S5</b>	-	-	-	-	-	-	-	99	99	99	99	



Emotion

**„Emotion“ VENICE A LED surface-mounted lighting**

For recess back panels

High-quality aluminium profile, stainless steel look for mounting on a recess back panel of 1.6 mm thickness

Light emotion: infinitely variable colour temperature from warm white (2700 K) to cold white (6500 K), incl.

Homogeneous light, without visible light spots

Dimming function

Fitted with LED Emotion 12 V DC

2 x 120 LEDs/m

12 W/m

Incl. 200 cm cable

Max. profile length 300 cm

End caps left and right are included in scope of delivery.

Cable outlet left

**This product contains a light source of energy efficiency class F.**

**Not available for:** Glass recess back panels

**Planning advice:** At a recess height of 48 cm, the height of the recess back panel is reduced by 4.5 cm.



per 10 cm Width

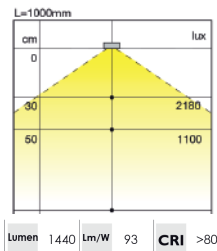
**NRW-LEDV**

19.40

**Connection piece for 90-degree corners for VENICE A „Emotion“ LED surface-mounted lighting**

**NRW-LEDV-VS90**

10.70



Emotion

**Built-in LED light Venice „Emotion“**

for indirect lighting in recess back panels (no glass recess back panels)

High-quality aluminium profile, stainless steel look

Light Emotion: infinitely variable colour temperature, from warm white (2700 K) to cold white (6500 K), including dimming function

**This product contains a light source of energy efficiency class F.** Cable outlet right

**Note:** At least 100 mm distance from top and bottom edge.

At least 50 mm distance from side edges.

Not available for glass recess back panels.

We recommend a minimum height of 480 mm for the recess back panel.

**An accurate dimensioned drawing is required for production!**



- 500 mm, 6.98 W, **NRW-LED50** 112
- for recess back panels over 600 mm wide
- 800 mm, 11.63 W, **NRW-LED80** 142
- for recess back panels over 900 mm wide
- 1100 mm, 16.28 W, **NRW-LED110** 174
- for recess back panels over 1200 mm wide
- 1400 mm, 20.93 W, **NRW-LED140** 202
- for recess back panels over 1500 mm wide
- 1700 mm, 25.58 W, **NRW-LED170** 237
- for recess back panels over 1800 mm wide
- 2000 mm, 30.23 W, **NRW-LED200** 264
- for recess back panels over 2100 mm wide
- 2300 mm, 34.88 W, **NRW-LED230** 299
- for recess back panels over 2400 mm wide

**Preparation of the recess back panels**

For built-in LED light Venice „Emotion“


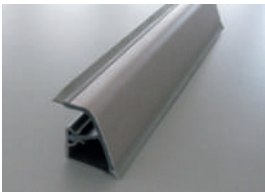


**An accurate dimensioned drawing is required for production!**

**MP-VNRWLED**

117



## Upstand system

	Order no.	Price
 <p><b>Upstand system</b> Only available in 5 m bars, height 25 mm Finish: E023M stainless look</p>	<b>WAPS</b>	48
<p><b>End cap for upstand</b> Finish: E023M stainless look</p>	<b>WAPS-EK</b>	5
<p><b>Inside corner 90° for upstand</b> Finish: E023M stainless look</p>	<b>WAPS-IE90</b>	5
<p><b>Outside corner 90° for upstand</b> Finish: E023M stainless look</p>	<b>WAPS-AE90</b>	5
<p><b>Inside corner 135° for upstand</b> Finish: E023M stainless look</p>	<b>WAPS-IE135</b>	5
<p><b>Mounting profile for recess cladding</b> Suitable for recess back panels 16 mm Length 300 cm</p>	<b>NRP</b>	26,50
<p><b>End cap for NRP R/L</b></p>	<b>NRP-EK</b>	5,20
<p><b>Transitional molding for NRP R/L</b></p>	<b>NRP-FT</b>	5,20
 <p><b>Upstand</b> Only available in 5 m bars, height 30 mm Available decor: E023M stainless steel-coloured incl. accessories required for the course of the wall such as end caps, inside corners (90° or 135°) and outside corners (90°)</p>	<b>WAP</b>	69
 <p><b>Accessories set in conjunction with article WAP</b> consisting of: 3 end caps left 3 end caps right 4 inside corners 90° 2 inside corners 135° 4 outside corners 90°</p>		
 <p><b>Accessories set as supplement</b> consisting of: 3 end caps left 3 end caps right 4 inside corners 90° 2 inside corners 135° 4 outside corners 90°</p>	<b>WAP-ZE</b>	18

# Recess back panels, printed motif

Please observe a minimum distance of 100 mm between the outer edge of a gas hob and a glass recess back panel in order to avoid damage to the glass recess back panel.

Order no.  
W H D

## Decor groups

		M10	M20	M30	M50	M60	M80	M90	G	N1	N2	N3	
	<b>Recess back panel, printed motif N1 (NRW-MotifK)</b> (Digital print on substrate coated with melamine resin, 3 layers of corundum lacquer with high resistance to abrasion) Colour of board: premium white Edge: premium white Dimensions: W max. 2400 mm, H 480/545 mm	per m <sup>2</sup> , W x H <b>NRW-MotivK</b>	-	-	-	-	-	-	-	297	-	-	
	<b>minimum price</b>	-	-	-	-	-	-	-	-	<b>110</b>	-	-	
		💡 <i>Information on motif 949: max. dimensions 2200 x 1200 mm</i>											
	<b>Recess back panel, printed motif N2 (NRW-MotifG)</b> (Digital print behind glass, 12 mm substrate, 4 mm safety glass) Colour of panel: premium white Edge: premium white Dimensions: W max. 2400 mm, H 480/545 mm	per m <sup>2</sup> , W x H <b>NRW-MotivG</b>	-	-	-	-	-	-	-	-	545	-	
	<b>minimum price</b>	-	-	-	-	-	-	-	-	-	<b>110</b>	-	
		💡 <i>Information on motif 949: max. dimensions 2200 x 1200 mm</i>											
	<b>Recess back panel, printed motif N2 (NRW-MotifG)</b> <b>Support panel, loose</b>	per m <sup>2</sup> , W x H <b>NRW-MOTIVGL</b>	-	-	-	-	-	-	-	-	545	-	
	<b>minimum price</b>	-	-	-	-	-	-	-	-	-	<b>110</b>	-	
		💡 <i>For reasons of transport safety, the substrate is supplied separately. Information on motif 949: max. dimensions 2200 x 1200 mm</i>											
	<b>Recess back panel, printed motif N3 (NRW-MotifGR)</b> (Digital print behind glass, 12 mm substrate, 4 mm safety glass) Colour of panel: premium white Edge: premium white Max. dimensions: W 2400 mm, H 480/545 mm	per m <sup>2</sup> , W x H <b>NRW-MotivGR</b>	-	-	-	-	-	-	-	-	-	642	
	<b>minimum price</b>	-	-	-	-	-	-	-	-	-	-	<b>110</b>	
		💡 <i>Information on motif 949: max. dimensions 2200 x 1200 mm</i>											
	<b>Recess back panel, printed motif N3 (NRW-MotifGLR)</b> Minimum dimension: 25 cm x 25 cm (Digital print behind glass, 12 mm substrate, 4 mm safety glass) Colour of panel: premium white Edge: premium white Max. dimensions: W 2400 mm, H 480/545 mm <b>Support panel, loose</b>	per m <sup>2</sup> , W x H <b>NRW-MOTIVGLR</b>	-	-	-	-	-	-	-	-	-	642	
	<b>minimum price</b>	-	-	-	-	-	-	-	-	-	-	<b>110</b>	
		💡 <i>For reasons of transport safety, the substrate is supplied separately.</i>											
<b>Extra charge mounting fittings</b> for digital print recess back panels Extra charge per panel		Unit price <b>MP-AHB-NRW</b>	-	-	-	-	-	-	-	85	85	85	85

N1		N2		N3	
N1 (NRW-MotivK)	N2 (NRW-MotivG)	N3 (NRW-MotivGR)			
928 Tile, Blue Grey	928 Tile, Blue Grey	949 Individual Motif Print			
929 Tile, Blue White	929 Tile, Blue White				
931 Tile, Brown Blue	931 Tile, Brown Blue				
938 Pepperoni	938 Pepperoni				
944 Stone Wall	944 Stone Wall				
947 Dandelion	947 Dandelion				
948 Stone Wall Light Grey	948 Stone Wall Light Grey				
949 Individual Motif Print	949 Individual Motif Print				
951 Stone Wall Dark Grey	951 Stone Wall Dark Grey				
952 Dry Stone Grey	952 Dry Stone Grey				
953 Light Stone wall	953 Light Stone wall				

# Recess back panels, printed motif

## Decor groups

Please observe a minimum distance of 100 mm between the outer edge of a gas hob and a glass recess back panel in order to avoid damage to the glass recess back panel.

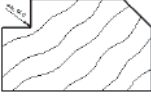
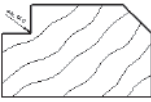
Order no.  
W H D

M10	M20	M30	M50	M60	M80	M90	G	N1	N2	N3
-----	-----	-----	-----	-----	-----	-----	---	----	----	----

Processing information for glass recess back panels with printed motif (N2 and N3)

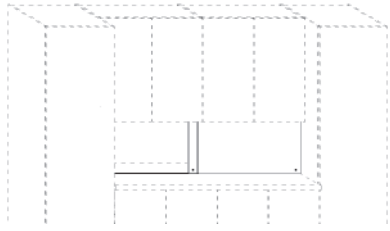
We cannot deliver the item without the exact dimensional drawing.  
Drill holes spaced at least 5 mm from edge

**Information on motif 949:** Alongside individual motifs with customer-supplied images, the standard motifs can be produced in various dimensions within 2200 x 1200 mm (e.g. motif 948 stone wall light grey sized 1500 x 800 mm).

	Unit price	M10	M20	M30	M50	M60	M80	M90	G	N1	N2	N3
 <p><b>Angled cut</b> For glass recess back panels, printed motif (N2 and N3)</p>	<b>NRW-MotivG-A</b>	-	-	-	-	-	-	-	-	84	84	84
 <p><b>Angled cutout</b> For glass recess back panels, printed motif (N2 and N3)</p> <p><b>Note:</b> Angled cutout min. R = 30 mm</p>	<b>NRW-MotivG-W</b>	-	-	-	-	-	-	-	-	84	84	84
<b>Drill hole diameter 5-50 mm</b>	<b>NRWG-L</b>	-	-	-	-	-	-	-	71	71	71	71
<b>Drill hole diameter 51-100 mm</b>	<b>NRWG-L51</b>	-	-	-	-	-	-	-	207	207	207	207
<b>Drill hole for single socket 68 mm dia.</b>	<b>NRWG-S1</b>	-	-	-	-	-	-	-	42	42	42	42
<b>Drill hole for double socket 68 x 139 mm dia.</b>	<b>NRWG-S2</b>	-	-	-	-	-	-	-	58	58	58	58
<b>Drill hole for triple socket 68 x 210 mm dia.</b>	<b>NRWG-S3</b>	-	-	-	-	-	-	-	71	71	71	71
<b>Drill hole for quadruple socket 68 x 281 mm dia.</b>	<b>NRWG-S4</b>	-	-	-	-	-	-	-	86	86	86	86
<b>Drill hole for quintuple socket 68 x 352 mm dia.</b>	<b>NRWG-S5</b>	-	-	-	-	-	-	-	99	99	99	99

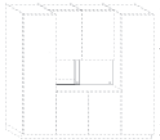


# Sliding doors / aperture design SlideLine M 2-rail



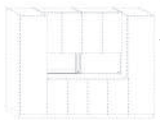
Design suggestion in conjunction with apertures  
 Design suggestion in conjunction with:  
 SL2NI 180

Order no. W H D	Hinge side:	Carcass depth	Price groups								
			1	2	3	4	5	6	7	8	9



**System 120 for apertures**  
 between 2 tall units and between worktop and wall unit  
 consisting of  
 Profile set 2-rail SlideLine M  
 2 sliding doors width 60.6 cm,  
 Variable height from 40 - 60 cm  
 complete with fittings  
 2 knobs K081  
 Sliding door height with aperture 48 cm: 46 cm  
 Profile set 2-rail SlideLine M  
 Front panels move offset to one another, thus the entire width can be closed completely.  
 Aluminium anodised  
**For use for apertures:**  
 For installation on worktops and below wall unit bottom shelves, for gluing and screwing  
 2 profiles, 300 cm long, to be shortened on-site  
 Stopper for the sliding doors and fixing material  
 Height 8.3 mm, depth 62 mm

<b>SL2NI120</b>			777	879	1019	1236	1260	1277	1503	1653	-
<b>Not available for:</b> ALU TEC RP, MIAMI, VIVA											
<b>Planning advice:</b> With free-standing configurations, panels are necessary left and right.											



**System 180 for apertures**  
 between 2 tall units and between worktop and wall unit  
 consisting of  
 Profile set 2-rail SlideLine M  
 2 sliding doors width 90.6 cm,  
 Variable height from 40 - 60 cm  
 complete with fittings  
 2 knobs K081  
 Sliding door height with aperture 48 cm: 46 cm  
 Profile set 2-rail SlideLine M  
 Front panels move offset to one another, thus the entire width can be closed completely.  
 Aluminium anodised  
**For use for apertures:**  
 For installation on worktops and below wall unit bottom shelves, for gluing and screwing  
 2 profiles, 300 cm long, to be shortened on-site  
 Stopper for the sliding doors and fixing material  
 Height 8.3 mm, depth 62 mm

<b>SL2NI180</b>			843	989	1205	1535	1570	1597	1933	2126	-
<b>Not available for:</b> ALU TEC RP, MIAMI, VIVA											
<b>Planning advice:</b> With free-standing configurations, panels are necessary left and right.											

# Accessories worktops / apertures

		Order no.	Price															
	<p><b>Socket strip</b>            EVOline® V Dock / USB-C            With fixed mains power cable 2.5 m long and separately enclosed plug.            2 sockets VDE and USB-C charger            Silver anodised profile            Length: 154 mm            Width: 69 mm            Depth 69 mm</p>	<b>EVO-VDC</b>	<input type="checkbox"/> 114															
	<p><b>Ventilation grille for top cover 50 x 8 cm</b>            Aluminium, anodised stainless steel-coloured</p>	<b>Z 101</b>	19,20															
	<p><b>Connection bracket set</b>            Set comprising            4 connection brackets incl. screws            for fitting worktops / panel constructions            Colour: black, powder coated</p>	<b>VBW4-SET</b>	<input type="checkbox"/> 56															
	<p><b>Base unit Blindcarcase</b>            for blind ceilings 90°             as support for worktop            width 40 cm            depth 45.5 cm            Available in all decors from decor group K</p>	<table border="1"> <tr> <td><b>UBK</b></td> <td><b>40</b></td> <td><b>72</b></td> <td><b>45</b></td> </tr> <tr> <td><b>UBK</b></td> <td><b>40</b></td> <td><b>78</b></td> <td><b>45</b></td> </tr> <tr> <td><b>UBK</b></td> <td><b>40</b></td> <td><b>85</b></td> <td><b>45</b></td> </tr> </table>	<b>UBK</b>	<b>40</b>	<b>72</b>	<b>45</b>	<b>UBK</b>	<b>40</b>	<b>78</b>	<b>45</b>	<b>UBK</b>	<b>40</b>	<b>85</b>	<b>45</b>	<table border="1"> <tr> <td>131</td> </tr> <tr> <td>136</td> </tr> <tr> <td>140</td> </tr> </table>	131	136	140
<b>UBK</b>	<b>40</b>	<b>72</b>	<b>45</b>															
<b>UBK</b>	<b>40</b>	<b>78</b>	<b>45</b>															
<b>UBK</b>	<b>40</b>	<b>85</b>	<b>45</b>															
131																		
136																		
140																		
																		

# Table attachment tops with thick edge 38 mm thick

The radii, angled cut dimensions and angles cannot be modified!

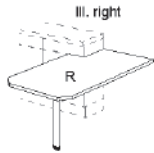
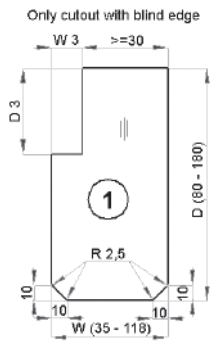


Table attachment

Only cutout with blind edge

ASTD60/1	R/L	228
ASTD118/1	R/L	300

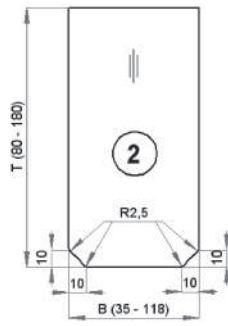


Table attachment

ASTD60/2		207
ASTD118/2		276

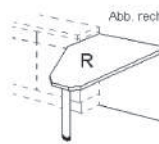
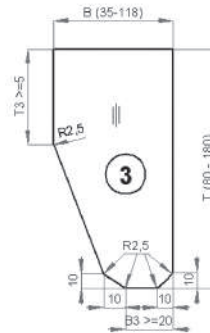


Table attachment

ASTD60/3	R/L	228
ASTD118/3	R/L	311

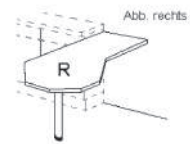


Table attachment

ASTD90/4	R/L	545
ASTD118/4	R/L	623

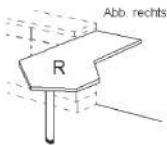
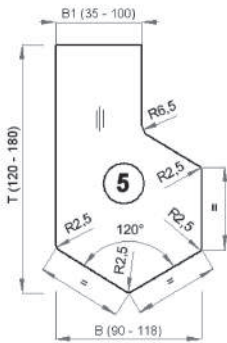


Table attachment

ASTD90/5	R/L	545
ASTD118/5	R/L	623

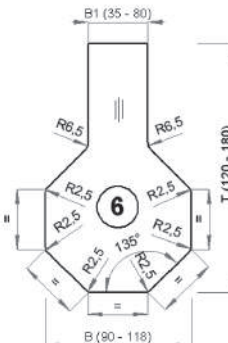


Table attachment

ASTD90/6		545
ASTD118/6		623

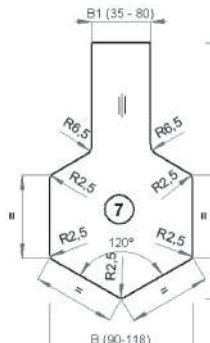


Table attachment

ASTD90/7		545
ASTD118/7		623

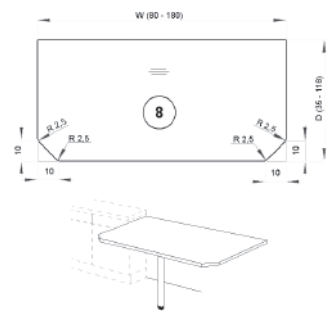


Table attachment

ASTD60/8		207
ASTD118/8		276

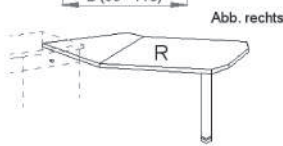
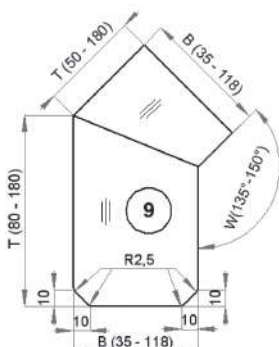


Table attachment

ASTD60/9	R/L	423
ASTD118/9	R/L	506

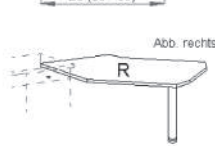
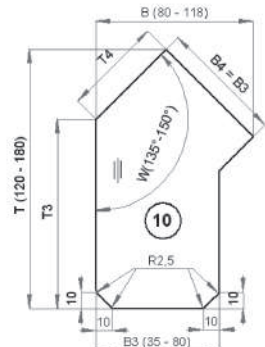


Table attachment

ASTD118/10	R/L	623
------------	-----	-----

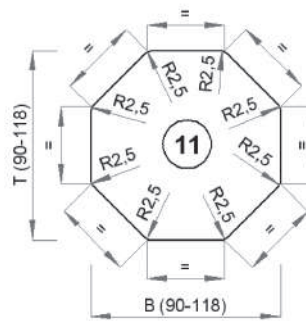


Table attachment

ASTD90/11		300
ASTD118/11		339

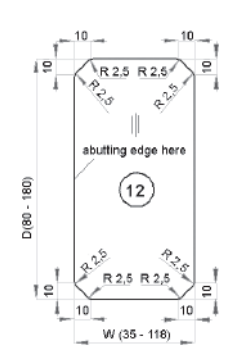


Table attachment

ASTD60/12		339
ASTD118/12		375

# Table attachment tops with thick edge 38 mm thick

The radii, angled cut dimensions and angles cannot be modified!

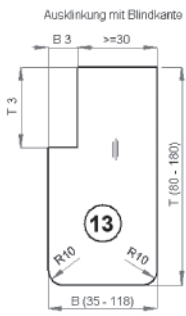


Abb. rechts

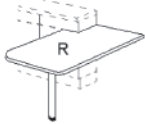


Table attachment Thick edge on all sides cutout with blind edge

ASTD60/13 R/L 228

ASTD118/13 R/L 300

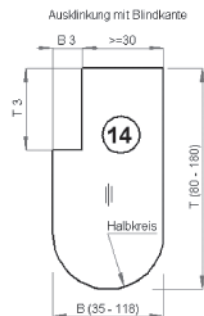


Abb. rechts

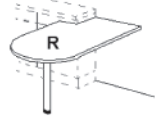


Table attachment Thick edge on all sides cutout with blind edge

ASTD60/14 R/L 228

ASTD118/14 R/L 300

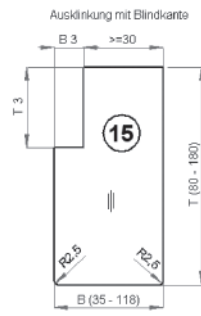


Abb. rechts

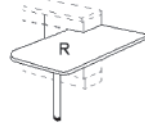


Table attachment Thick edge on all sides cutout with blind edge

ASTD60/15 R/L 228

ASTD118/15 R/L 300

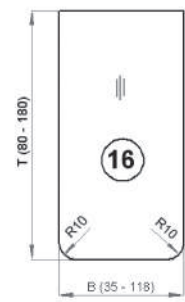


Table attachment Thick edge on all sides

ASTD60/16 207

ASTD118/16 276

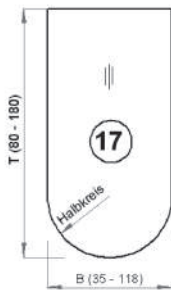


Table attachment Thick edge on all sides

ASTD60/17 207

ASTD118/17 276

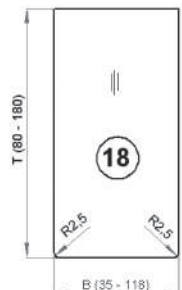


Table attachment Thick edge on all sides

ASTD60/18 207

ASTD118/18 276

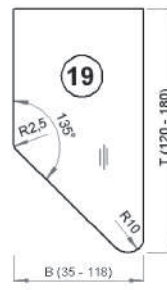


Abb. rechts

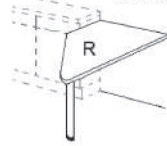


Table attachment Thick edge on all sides

ASTD60/19 R/L 228

ASTD118/19 R/L 311

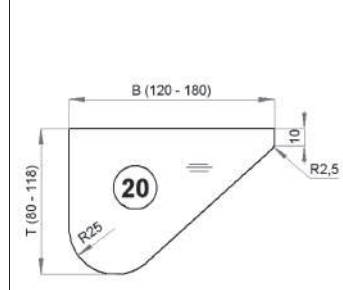


Abb. rechts

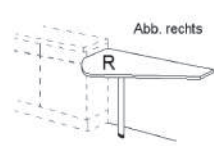


Table attachment Thick edge on all sides

ASTD90/20 R/L 228

ASTD118/20 R/L 311

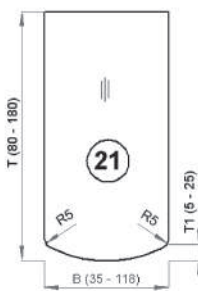


Table attachment Thick edge on all sides

ASTD60/21 207

ASTD118/21 276



Abb. rechts

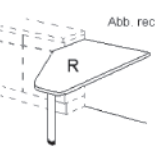


Table attachment Thick edge on all sides

ASTD60/22 R/L 228

ASTD118/22 R/L 311



Abb. rechts

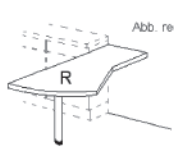


Table attachment Thick edge on all sides

ASTD90/23 R/L 267

ASTD118/23 R/L 311

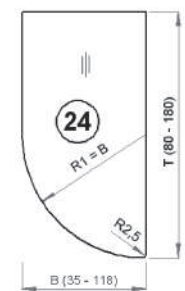


Abb. rechts

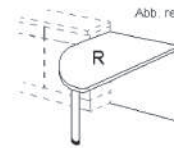


Table attachment Thick edge on all sides

ASTD60/24 R/L 228

ASTD118/24 R/L 311

# Table attachment tops with thick edge 38 mm thick

The radii, angled cut dimensions and angles cannot be modified!

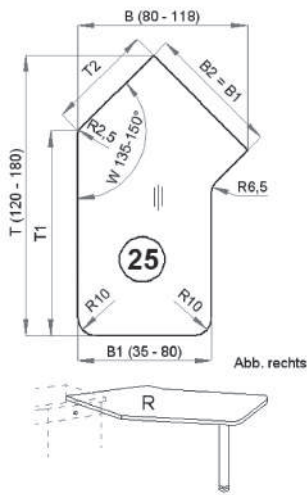


Table attachment Thick edge on all sides

ASTD118/25 R/L 623



Table attachment Thick edge on all sides

ASTD118/26 R/L 623

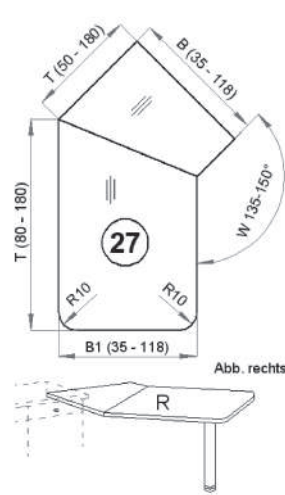


Table attachment Thick edge on all sides

ASTD60/27 R/L 423

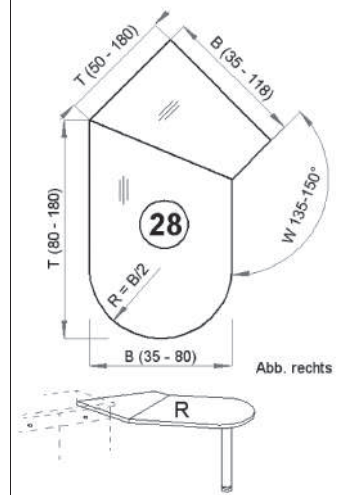


Table attachment Thick edge on all sides

ASTD60/28 R/L 423

ASTD118/27 R/L 506

ASTD118/28 R/L 506

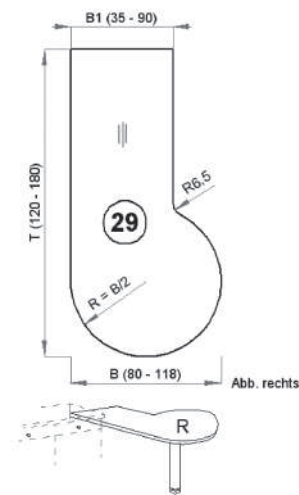


Table attachment Thick edge on all sides

ASTD60/29 R/L 505

ASTD118/29 R/L 582

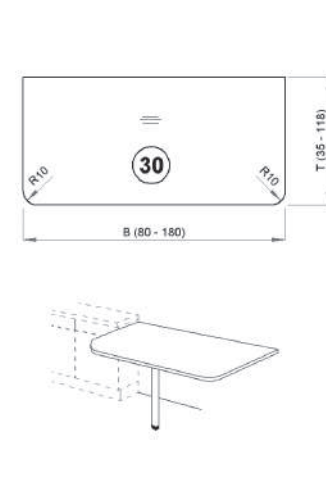


Table attachment Thick edge on all sides

ASTD60/30 207

ASTD118/30 276

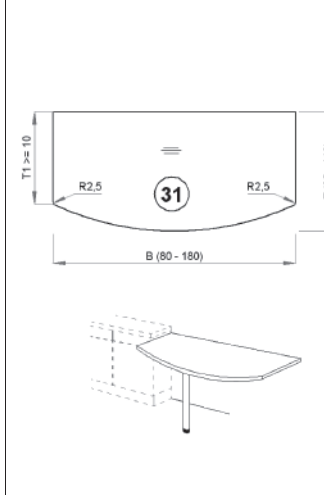


Table attachment Thick edge on all sides

ASTD60/31 207

ASTD118/31 276

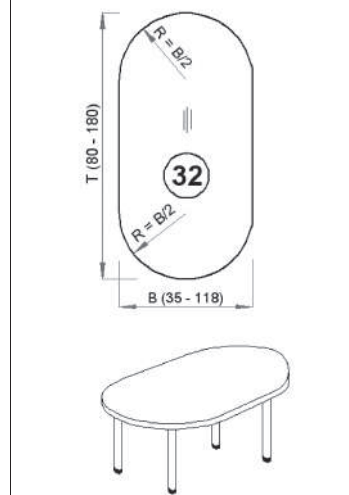


Table attachment Thick edge on all sides

ASTD60/32 339

ASTD118/32 375

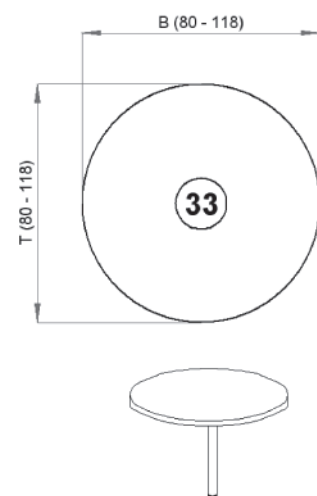


Table attachment Thick edge on all sides

ASTD60/33 300

ASTD118/33 339

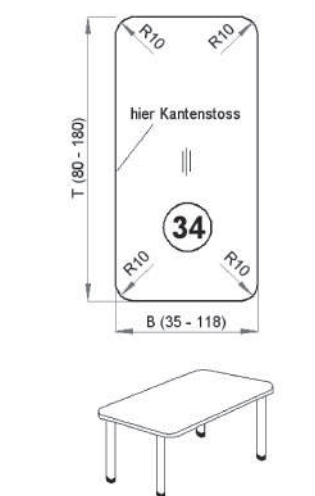


Table attachment Thick edge on all sides

ASTD60/34 339

ASTD118/34 375

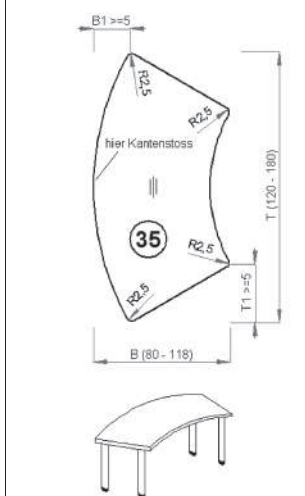


Table attachment Thick edge on all sides

ASTD118/35 R/L 375

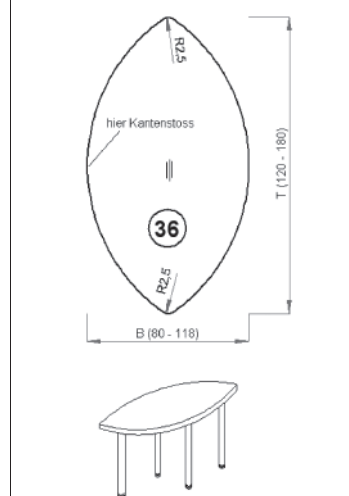


Table attachment Thick edge on all sides

ASTD118/36 375

# Table attachment tops with thick edge 38 mm thick

The radii, angled cut dimensions and angles cannot be modified!

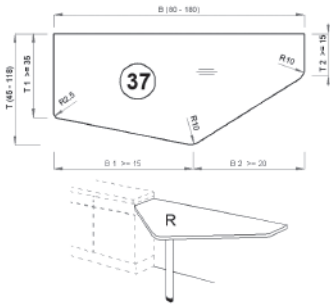


Table attachment Thick edge on all sides

ASTD60/37	R/L	228
ASTD118/37	R/L	311

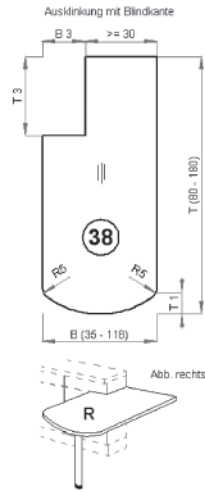


Table attachment Thick edge on all sides Only cutout with blind edge

ASTD60/38	R/L	228
ASTD118/38	R/L	300

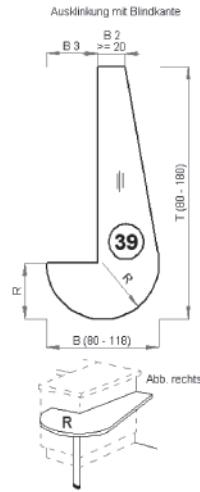


Table attachment Thick edge on all sides cutout with blind edge

ASTD60/39	R/L	228
ASTD118/39	R/L	311

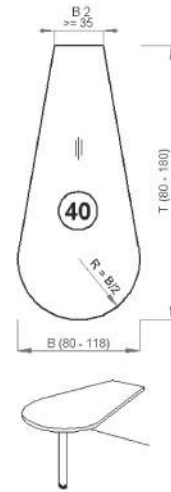


Table attachment Thick edge on all sides

ASTD60/40		228
ASTD118/40		311

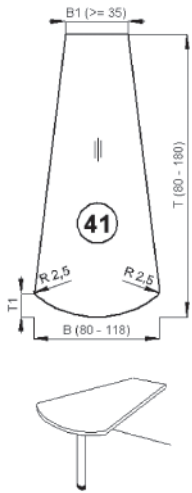


Table attachment Thick edge on all sides

ASTD60/41		228
ASTD118/41		311

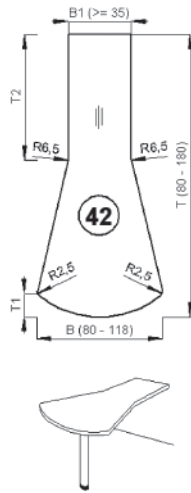


Table attachment Thick edge on all sides

ASTD60/42		545
ASTD118/42		623

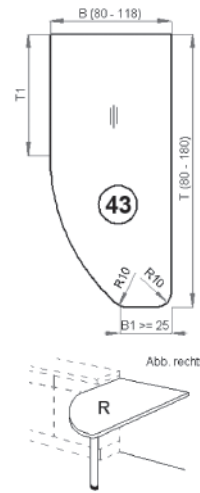


Table attachment Thick edge on all sides

ASTD60/43	R/L	228
ASTD118/43	R/L	311

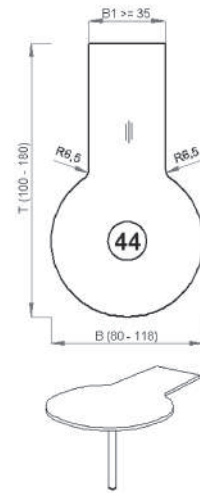


Table attachment Thick edge on all sides

ASTD60/44		545
ASTD118/44		623



Table attachment Thick edge on all sides

ASTD60/45	R/L	228
ASTD118/45	R/L	311

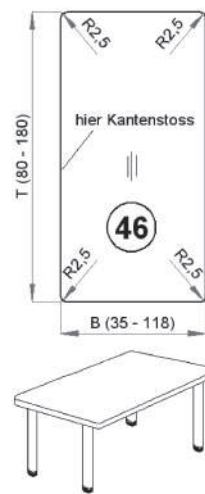


Table attachment Thick edge on all sides

ASTD60/46		339
ASTD118/46		375

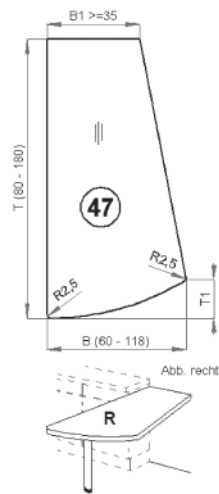


Table attachment Thick edge on all sides

ASTD60/47	R/L	228
ASTD118/47	R/L	311



Table attachment Thick edge on all sides

ASTD60/48		339
ASTD118/48		375

# 5

## Wall units / dresser units

Heights 26 cm / 39 cm

Heights 52 cm / 65 cm

Height 78 cm

Height 91 cm

Heights 104 / 117 / 130 cm

Chimney hoods, canopy hood

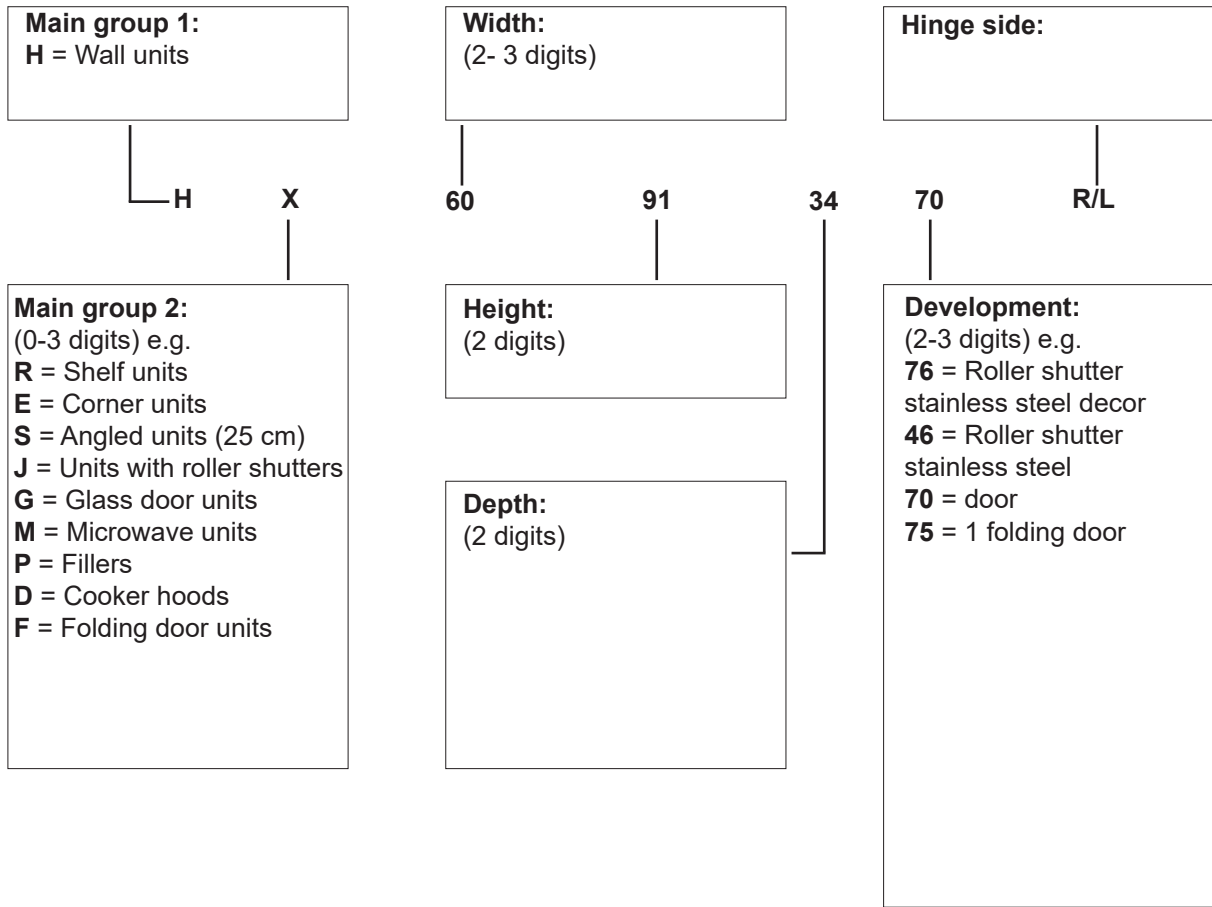
Dresser units

Sliding doors for wall units



# Technical information - wall units

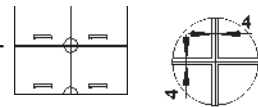
## Explanation of order number



5 Wall units / dresser units

### Product advantages:

- Metal interior fittings with galvanised brilliant chrome plating
- Interior decor identical to carcass exterior
- Wall units with glass doors with glass shelves as standard
- **High-quality appearance through uniform gap alignment**
- Corner wall units available in different widths
- Full-depth shelves with anti-tilting safety device
- Wall units in 91 cm height equipped with **3 hinges**
- Units with roller shutters 45-50-60-80-90 cm width



# 5.1

## Wall units, 26 cm / 39 cm high

Wall units 26 cm high	XL 5.1.2
Front filler 26 cm high	XL 5.1.2
Wall units, 26 cm high with glass fronts model-specific	XL 5.1.2
Additional equipment	XL 5.1.2
Wall units, 26 cm high with glass fronts neutral	XL 5.1.3
Wall shelf units 26 cm high	XL 5.1.3
Background filler 26 cm high	XL 5.1.3
Visible sides / increased side depth 26 cm high	XL 5.1.4
Wall units, 39 cm high	XL 5.1.5
Front filler 39 cm high	XL 5.1.6
Wall units 39 cm high with glass fronts model-specific	XL 5.1.6
Wall units 39 cm high with glass fronts neutral	XL 5.1.6-XL 5.1.7
Wall shelf units 39 cm high	XL 5.1.7
Smart Cube wall shelf unit 39 cm high	XL 5.1.8
Visible sides / increased side depth 39 cm high	XL 5.1.8
Background filler 39 cm high	XL 5.1.9
Additional equipment	XL 5.1.9
Front extension 39 cm high	XL 5.1.10

### Legend:



Available with grip ledge N...



Not available with grip ledge N...



This symbol indicates which models are available



This symbol indicates which models are not available



Planning advice



# The most important wall unit models 26 cm high

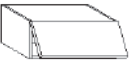
Page XL 5.1.2	Page XL 5.1.2	Page XL 5.1.2	Page XL 5.1.2	Page XL 5.1.3	Page XL 5.1.3	Page XL 5.1.3
<b>H..263478</b>	<b>HP..26</b>	<b>HPW..26</b>	<b>HG..2634RA</b>	<b>HGDA..263478</b>	<b>HGD..263478</b>	<b>HR..2636</b>
Unit widths: 30/40/45/50/60 80/90/100/120	Unit widths: 3,5-20	Unit widths: 60X60	Unit widths: 60/90	Unit widths: 60/80/90/100	Unit widths: 45/50/60 /80/90/100/120	Unit widths: 30/40/45/50/60 80/90

# The most important wall unit models 39 cm high


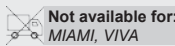
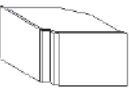
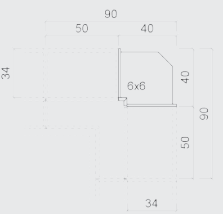
Page XL 5.1.5	Page XL 5.1.5	Page XL 5.1.5	Page XL 5.1.5	Page XL 5.1.5	Page XL 5.1.5	Page XL 5.1.5	Page XL 5.1.6	Page XL 5.1.6
<b>H..393470</b>	<b>H..393470</b>	<b>H..393478</b>	<b>HL..393478</b>	<b>HL..393478</b>	<b>HL..393478</b>	<b>HS..393470</b>	<b>HP..39</b>	<b>HPW..39</b>
Unit widths: 30/40/45/50/60	Unit widths: 80/90/100/120	Unit widths: 30/40/45/50/60 80/90/100/120	Unit widths: 45/50/60/ 80/90/100	Unit widths: 120/180	Unit widths: 120/180	Unit widths: 25	Unit widths: 3,5-20	Unit widths: 60X60
Page XL 5.1.6	Page XL 5.1.6	Page XL 5.1.6	Page XL 5.1.6	Page XL 5.1.6	Page XL 5.1.7	Page XL 5.1.7	Page XL 5.1.7	Page XL 5.1.7
<b>HAE..34</b>	<b>HG..3934RA</b>	<b>HGD..393470</b>	<b>HGD..393470</b>	<b>HGD..393478</b>	<b>HGLD..3934</b>	<b>HGDA..393478</b>	<b>HGLDA..3934</b>	<b>HR..3936</b>
Unit widths: 4,8	Unit widths: 60/90	Unit widths: 45/50/60	Unit widths: 90/100	Unit widths: 45/50/60 /80/90/100/120	Unit widths: 45/50/60/ 80/90/100	Unit widths: 60/80/90/100	Unit widths: 60/80/90/100	Unit widths: 30/40/45/50/60

## Wall units 26 cm high

Carcase depth 34 cm

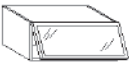
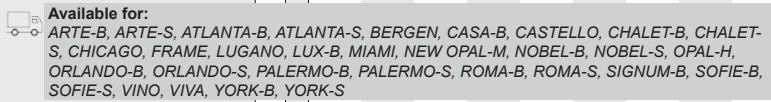

						Price groups										
		Order no.		W H D		Hinge side:	Carcase depth	1	2	3	4	5	6	7	8	9
256		<b>Wall unit</b> 1 flap door 25.6 cm		<b>H</b>	<b>30 26 34 78</b>			234	237	260	298	312	323	330	363	-
					<b>40 26 34 78</b>			234	237	260	298	312	323	341	375	-
					<b>45 26 34 78</b>			234	237	260	298	312	323	341	375	-
					<b>50 26 34 78</b>			235	237	260	298	320	328	349	384	-
					<b>60 26 34 78</b>			239	249	267	308	326	337	363	399	-
					<b>80 26 34 78</b>			242	249	273	325	340	360	393	432	-
					<b>90 26 34 78</b>			242	249	273	325	340	360	393	432	-
					<b>100 26 34 78</b>			251	258	285	338	356	371	410	451	-
					<b>120 26 34 78</b>			259	268	295	353	368	385	425	468	-

## Front filler 26 cm high

256		<b>Wall unit front filler</b> 3.5 - 10 cm 10.1 - 20 cm		<b>HP</b>	<b>10 26</b>			43	43	47	64	64	64	69	76	-
					<b>20 26</b>			52	52	55	82	82	82	89	98	-
256		<b>Wall unit intermediate filler</b> 3.5 - 20 cm		<b>HPZ</b>	<b>20 26</b>			50	50	53	71	71	71	75	83	-
																
256		<b>Wall unit corner filler</b> 26 x 26 cm, with top and bottom shelf can be used instead of a 60 x 60 cm corner wall unit. Corner dimensions: from 6 x 6 cm (planning dimensions 40 x 40 cm) up to 26 x 26 cm (planning dimensions 60 x 60 cm) available		<b>HPW</b>	<b>26 26</b>			228	242	288	368	368	389	426	469	-
																

## Wall units, 26 cm high with glass fronts model-specific

Carcase depth 34 cm

256		<b>Wall unit</b> -model-specific- 1 flap door with glass front 25.6 cm		<b>HG</b>	<b>60 26 34 RA</b>			-	-	332	369	390	402	423	465	-
					<b>90 26 34 RA</b>			-	-	335	385	414	432	471	518	-
																
																

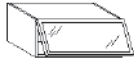

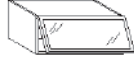
## Additional equipment

								Decor groups									
		Order no.		W H D		Hinge side:	Carcase depth	M10	M20	M30	M40	M50	M60	M70	M80	M90	
		<b>Surcharge for wall cabinets with glass fronts inside and exterior in the same design</b> available in decor groups: S/B/H/MP/F/Z		<b>IDF-H</b>				-	-	-	-	495	-	495	495	-	

M 10	M 20	M 30	M 40	M 50
K M10 laminate				B M50 Velvet lacquer S M50 microstructure lacquer
M 60	M 70	M 80	M 90	
	F M70 veneer / oak / walnut Z M70 Veneer / Bavaria	H M80 high gloss-Lacquer MP M80 laqué mat Premium		

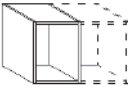
# Wall units, 26 cm high with glass fronts neutral

Carcase depth 34 cm


				Glass groups																
				Order no.		Hinge side:	Carcase depth													
				W H D				G1	G2	G2S	G5S	G6								
 <p><b>Wall unit with glass front</b> -neutral- 1 flap door with AktivGlas front 25.6 cm</p>	AKTIV GLAS	HGDA 60 26 34 78		423	-	-	-	-	-	-	-	-	-	-	-	-	-	-	-	
		HGDA 80 26 34 78		461	-	-	-	-	-	-	-	-	-	-	-	-	-	-	-	-
		HGDA 90 26 34 78		474	-	-	-	-	-	-	-	-	-	-	-	-	-	-	-	-
		HGDA100 26 34 78		478	-	-	-	-	-	-	-	-	-	-	-	-	-	-	-	-
				 with grip ledge in bottom shelf Without drill hole for handle, knobs/handles not possible																
 <p><b>Wall unit with glass front</b> -neutral- 1 flap door 25.6 cm with glass front</p>	HGD 45 26 34 78		-	488	-	-	-	-	-	-	-	-	-	-	-	-	-	-	-	
	HGD 50 26 34 78		-	491	-	-	-	-	-	-	-	-	-	-	-	-	-	-	-	-
	HGD 60 26 34 78		-	512	-	-	-	-	-	-	-	-	-	-	-	-	-	-	-	-
	HGD 80 26 34 78		-	579	-	-	-	-	-	-	-	-	-	-	-	-	-	-	-	-
	HGD 90 26 34 78		-	595	-	-	-	-	-	-	-	-	-	-	-	-	-	-	-	-
	HGD 100 26 34 78		-	613	-	-	-	-	-	-	-	-	-	-	-	-	-	-	-	-
	HGD 120 26 34 78		-	652	-	-	-	-	-	-	-	-	-	-	-	-	-	-	-	-
<b>G1</b>		<b>G2</b>		<b>G2S</b>																
<b>G1 AKTIVglass frame</b> 991 Matt glass 992 Translucent black glass		<b>G2 Design front</b> 925 Frame White Agate/Matt glass 935 Premium W. Frame/Matt Glass 940 Macaron Col. Frame/Matt Glass 95 Light grey frame/matt glass 96 Silver Col. Frame/Matt Glass 960 Snow White Frame/Matt Glass 97 Black frame/black glass		<b>G2S aluminium, framed glass door</b> 988 aluminium black, Linea glass 994 Aluminium frame/clear glass 995 aluminium frame/black glass																
<b>G5</b>		<b>G5S</b>		<b>G6</b>																
		G5S aluminium, door with mullion 996 Alum.frame/clear gl./cross bar		<b>G6 NEW SALON</b> 986 aluminium black, black glass 987 aluminium black, clear glass 989 aluminium matt, bronze-coloured black glass 990 aluminium matt, bronze-coloured clear glass																

# Wall shelf units 26 cm high

Carcase depth 36.1 cm


				Decor groups													
				Order no.		Hinge side:	Carcase depth										
				W H D				M10	M20	M30	M40	M50	M60	M70	M80	M90	
 <p><b>Wall shelf unit</b> wide in cm: 13-30 wide in cm: 30,1-40 wide in cm: 40,1-45 wide in cm: 45,1-50 wide in cm: 50,1-60 wide in cm: 60,1-80 wide in cm: 80,1-90</p>	HR 30 26 36		137	-	-	-	267	-	267	267	-	-	-	-			
	HR 40 26 36		137	-	-	-	267	-	267	267	-	-	-	-			
	HR 45 26 36		137	-	-	-	267	-	267	267	-	-	-	-			
	HR 50 26 36		137	-	-	-	267	-	267	267	-	-	-	-			
	HR 60 26 36		137	-	-	-	267	-	267	267	-	-	-	-			
	HR 80 26 36		146	-	-	-	454	-	464	707	-	-	-	-			
	HR 90 26 36		146	-	-	-	454	-	464	707	-	-	-	-			
	<b>M10</b>		<b>M20</b>		<b>M30</b>		<b>M40</b>		<b>M50</b>								
K M10 laminate								B M50 Velvet lacquer S M50 microstructure lacquer									
<b>M60</b>		<b>M70</b>		<b>M80</b>		<b>M90</b>											
		F M70 veneer / oak / walnut Z M70 Veneer / Bavaria		H M80 high gloss-Lacquer MP M80 laqué mat Premium													

# Background filler 26 cm high

				Decor groups													
				Order no.		Hinge side:	Carcase depth										
				W H D				M10	M20	M30	M40	M50	M60	M70	M80	M90	
 <p><b>Wall unit background filler</b> Width: 20 cm For fitting flush with carcass</p>	HPSL 00 26		21,40	22,80	22,80	22,80	22,80	22,80	22,80	22,80	22,80	22,80	22,80	-			
	HS		39	129	176	233	234	244	244	244	244	244	244	-			
<b>M10</b>		<b>M20</b>		<b>M30</b>		<b>M40</b>		<b>M50</b>									
K M10 laminate		D M20 Laminate decor		I M30 RESOPAL PRO super matt IH M30 HPL PRO PW M30 PRIMEWOOD/Basic Veneer		A M40 DIRECTLACK matt L M40 DIRECTLACK high-gloss		B M50 Velvet lacquer P M50 Soft lacquer S M50 microstructure lacquer									
<b>M60</b>		<b>M70</b>		<b>M80</b>		<b>M90</b>											
QH M60 SMARTGLAS high-gloss QM M60 SMARTGLAS satin-finish		F M70 veneer / oak / walnut Z M70 Veneer / Bavaria		C1 M80 FENIX stainless-steel look H M80 high gloss-Lacquer MP M80 laqué mat Premium													


# Visible sides / increased side depth 26 cm high

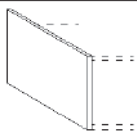
Order no.  
W H D

		Decor groups									
Hinge side:	Carcase depth	M10	M20	M30	M40	M50	M60	M70	M80	M90	
R/L		0	0	47	47	63	63	65	70	-	
 <b>Important!</b> Installation instead of a normal unit side.											




Wall unit visible side

<b>HSV 26</b>	R/L	0	0	47	47	63	63	65	70	-	
 <b>Important!</b> Installation instead of a normal unit side.											



Wall unit increased side depth  
Up to 57.5 cm side depth

<b>HSVT 26</b>	R/L	57	65	102	102	136	136	140	145	-	
 <b>Important!</b> Installation instead of a normal unit side.											

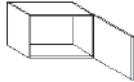
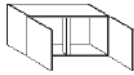
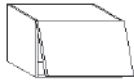
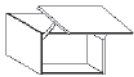

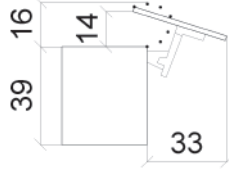



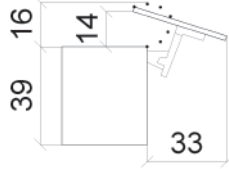
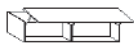



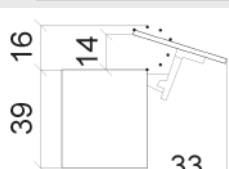
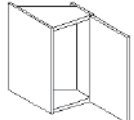
M 10	M 20	M 30	M 40	M 50
K M10 laminate	D M20 Laminate decor	I M30 RESOPAL PRO super matt IH M30 HPL PRO PW M30 PRIMEWOOD/Basic Veneer	A M40 DIRECTLACK matt L M40 DIRECTLACK high-gloss	B M50 Velvet lacquer P M50 Soft lacquer RH M50 Velvet lacquer wood texture RW M50 Velvet lacquer spackle effect S M50 microstructure lacquer

M 60	M 70	M 80	M 90
QH M60 SMARTGLAS high-gloss QM M60 SMARTGLAS satin-finish	F M70 veneer / oak / walnut V M70 Velvet lacquer textured Z M70 Veneer / Bavaria	C1 M80 FENIX stainless-steel look H M80 high gloss-Lacquer MP M80 laqué mat Premium O M80 Veneered	





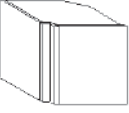
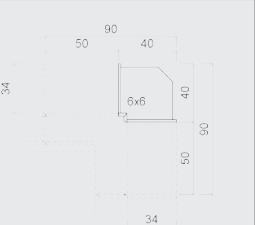
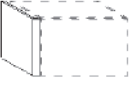
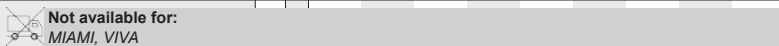
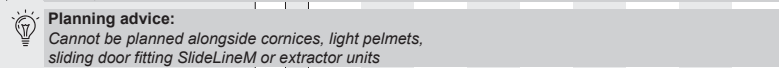
# Wall units, 39 cm high

Carcase depth 34 cm

						Price groups												
		Order no.				Hinge side:	Carcase depth	1	2	3	4	5	6	7	8	9		
		W	H	D														
386	 <b>Wall unit</b> 1 door 38.6 cm		H	30	39	34	70	R/L	119	123	146	186	200	210	218	240	-	
			H	40	39	34	70	R/L	119	123	146	186	200	210	230	253	-	
			H	45	39	34	70	R/L	119	123	146	186	200	210	230	253	-	
			H	50	39	34	70	R/L	120	123	146	186	207	216	236	260	-	
			H	60	39	34	70	R/L	124	131	149	193	214	226	251	276	-	
386	 <b>Wall unit</b> 2 doors 38.6 cm		H	80	39	34	70		156	163	188	288	330	349	378	416	-	
			H	90	39	34	70		156	163	188	288	338	360	393	432	-	
			H	100	39	34	70		156	163	188	298	351	365	402	442	-	
			H	120	39	34	70		211	222	259	357	392	411	449	494	-	
386	 <b>Wall unit</b> 1 flap door 38.6 cm		H	30	39	34	78		236	242	264	301	317	326	334	367	-	
			H	40	39	34	78		236	242	264	301	317	326	346	381	-	
			H	45	39	34	78		236	242	264	301	317	326	346	381	-	
			H	50	39	34	78		237	242	264	301	323	331	355	391	-	
			H	60	39	34	78		244	250	271	312	330	341	366	403	-	
			H	80	39	34	78		246	251	276	329	349	366	402	442	-	
			H	90	39	34	78		246	251	276	329	349	366	402	442	-	
			H	100	39	34	78		253	260	288	341	363	377	416	458	-	
			H	120	39	34	78		261	270	300	356	373	393	432	475	-	
386	 <b>Wall unit</b> 1 front 38.6 cm with lift-up fitting		HL	45	39	34	78		325	331	355	392	403	419	441	485	-	
			HL	50	39	34	78		325	331	355	392	410	423	444	488	-	
			HL	60	39	34	78		330	338	360	398	414	427	448	493	-	
			HL	80	39	34	78		403	410	435	483	536	554	587	646	-	
			HL	90	39	34	78		403	410	435	483	536	554	587	646	-	
			HL	100	39	34	78		414	420	444	494	550	568	604	664	-	
			 Do not plan in conjunction with cornices and top covers! Please observe a minimum distance of 17.5 cm between the top edge of the unit and the ceiling.															
																		
386	 <b>Wall unit</b> consisting of: 2 x 60 cm wide carcasses, overall carcase width 120 cm 1 full-width lifting door 38.6 cm high and 119.6 cm wide with lift-up fitting		HL	120	39	34	78		694	708	756	834	867	900	946	1041	-	
			 Not available for: BERGEN, FRAME, LUGANO, MIAMI, STRIP ELEMENTS, VIVA															
			 Do not plan in conjunction with cornices and top covers! Please observe a minimum distance of 17.5 cm between the top edge of the unit and the ceiling.															
																		
386	 <b>Wall unit</b> consisting of: Width 180 cm: 2 x 90 cm wide carcasses, overall carcase width 180 cm 1 full-width lifting door 38.6 cm high and 179.6 cm wide with lift-up fitting		HL	180	39	34	78		844	861	913	1013	1127	1163	1235	1359	-	
			 Not available for: ALU TEC RP, ALUELEMENTS, ATLANTA-B, ATLANTA-S, BERGEN, CASTELLO, CHALET-B, CHALET-S, CHICAGO, FENIX INOX, FRAME, HPL PRO, INTARSIA, LUGANO, LUX-B, MIAMI, MON- TANA, MPX, NEVADA, NOBEL-B, NOBEL-S, ORLANDO-B, ORLANDO-S, PUR, RESOPAL PRO, RESOPAL PRO EDGE, RUSTY OAK, SMART-M, SOFIE-B, SOFIE-S, STRIP ELEMENTS, TALEA, TESSIN 15, TIM, TIM 15, VINO, VIVA, YORK-B, YORK-S															
			 Do not plan in conjunction with cornices and top covers! Please observe a minimum distance of 17.5 cm between the top edge of the unit and the ceiling. <b>Available handles:</b> from a drilling distance of 128 mm															
																		
386	 <b>Wall unit angled by 37.2°</b> 25 cm wide 1 door 38.6 cm high For adjacent fitting left or right		HS	25	39	34	70	R/L	204	211	217	253	261	269	292	321	-	

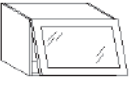
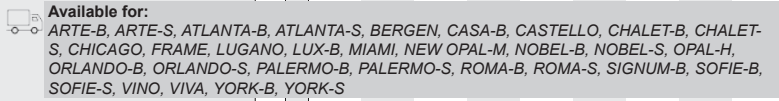
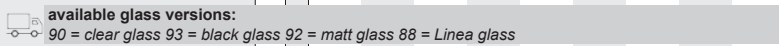
## Front filler 39 cm high

Carcase depth 34 cm

				Price groups											
				Hinge side:	Carcase depth	1	2	3	4	5	6	7	8	9	
Order no.															
W H D															
386		<b>Wall unit front filler</b> 3.5 - 10 cm 10.1 - 20 cm													
			HP	10	39		46	46	49	67	67	67	71	78	-
			HP	20	39		54	54	57	84	84	84	93	102	-
386		<b>Wall unit intermediate filler</b> 3.5 - 20 cm	HPZ	20	39		55	55	57	84	84	84	93	102	-
															
386		<b>Wall unit corner filler</b> 26 x 26 cm, with top and bottom shelf, can be used instead of a 60 x 60 cm corner wall unit Corner dimensions: from 6 x 6 cm (planning dimensions 40 x 40 cm) up to 26 x 26 cm (planning dimensions 60 x 60 cm) available													
			HPW	26	39		239	253	300	377	377	400	438	482	-
															
386		<b>Wall unit end panel</b> on one side Front material 4.8 cm wide, 38.6 cm high, depth 36.1 cm													
			HAE	39	34		240	248	271	297	329	329	347	382	-
															
															
		<b>Wall unit end panel</b> on one side Front material 4.8 cm wide, 38.6 cm high, depth 36.1 cm	HAEG	39	34		-	-	-	-	-	-	737	811	-

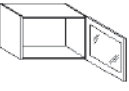
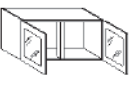
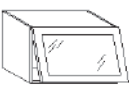
## Wall units 39 cm high with glass fronts model-specific

Carcase depth 34 cm

386		<b>Wall unit</b> -model-specific- 1 flap door with glass front 38.6 cm															
			HG	60	39	34	RA		-	-	337	373	396	409	430	473	-
			HG	90	39	34	RA		-	-	355	407	424	440	478	526	-
																	
																	



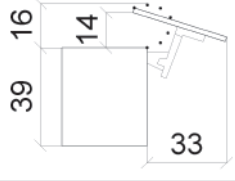


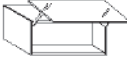

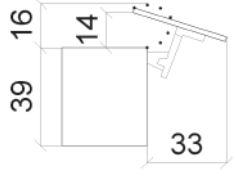
## Wall units 39 cm high with glass fronts neutral

Carcase depth 34 cm

				Glass groups									
				Hinge side:	Carcase depth	G1	G2	G2S	G5S	G6			
Order no.													
W H D													
386		<b>Wall unit with glass door</b> -neutral- 1 glass door 38.6 cm											
			HGD	45	39	34	70	R/L	-	413	412	-	792
			HGD	50	39	34	70	R/L	-	432	435	-	815
			HGD	60	39	34	70	R/L	-	455	471	-	851
386		<b>Wall unit with glass door</b> -neutral- 2 glass doors 38.6 cm											
			HGD	90	39	34	70		-	711	723	-	1042
			HGD	100	39	34	70		-	738	751	-	1089
386		<b>Wall unit with glass front</b> -neutral- 1 flap door 38.6 cm with glass front											
			HGD	45	39	34	78		-	515	-	-	-
			HGD	50	39	34	78		-	518	-	-	-
			HGD	60	39	34	78		-	541	-	-	-
			HGD	80	39	34	78		-	606	-	-	-
			HGD	90	39	34	78		-	628	-	-	-
			HGD	100	39	34	78		-	652	-	-	-
			HGD	120	39	34	78		-	697	-	-	-


# Wall units 39 cm high with glass fronts neutral

Carcase depth 34 cm

			Glass groups						
Order no. W H D			Hinge side:	Carcase depth	G1	G2	G2S	G5S	G6
386  <b>Wall unit</b> -neutral- 1 glass front 38.6 cm with lift-up fitting		HGLD 45 39 34			-	602	-	-	-
		HGLD 50 39 34			-	605	-	-	-
		HGLD 60 39 34			-	628	-	-	-
		HGLD 80 39 34			-	789	-	-	-
		HGLD 90 39 34			-	797	-	-	-
		HGLD100 39 34			-	826	-	-	-
			 Do not plan in conjunction with cornices or top covers. Please observe a minimum distance of 17.5 cm between the top edge of the unit and the ceiling.						
									
386  <b>Wall unit with glass front</b> -neutral- 1 flap door with AktivGlas front 38.6 cm	AKTIV GLAS	HGDA 60 39 34 78			425	-	-	-	-
		HGDA 80 39 34 78			467	-	-	-	-
		HGDA 90 39 34 78			477	-	-	-	-
		HGDA100 39 34 78			499	-	-	-	-
			 Without drill hole for handle, knobs/handles not possible with grip ledge in bottom shelf						
386  <b>Wall unit</b> -neutral- 1 AktivGlas front 38.6 cm with lift-up fitting	AKTIV GLAS	HGLDA60 39 34			519	-	-	-	-
		HGLDA80 39 34			652	-	-	-	-
		HGLDA90 39 34			652	-	-	-	-
		HGLDA100 39 34			675	-	-	-	-
			 Without drill hole for handle, knobs/handles not possible with grip ledge in bottom shelf Do not plan in conjunction with cornices or top covers. Please observe a minimum distance of 17.5 cm between the top edge of the unit and the ceiling.						
									
<b>G 1</b>			<b>G 2</b>			<b>G 2S</b>			
<b>G1 AKTIVglass frame</b> 991 Matt glass 992 Translucent black glass			<b>G2 Design front</b> 925 Frame White Agate/Matt glass 935 Premium W. Frame/Matt Glass 940 Macaron Col. Frame/Matt Glass 95 Light grey frame/matt glass 96 Silver Col. Frame/Matt Glass 960 Snow White Frame/Matt Glass 97 Black frame/black glass			<b>G2S aluminium, framed glass door</b> 988 aluminium black, Linea glass 994 Aluminium frame/clear glass 995 aluminium frame/black glass			
<b>G 5</b>			<b>G 5S</b>			<b>G 6</b>			
			G5S aluminium, door with mullion 996 Alum.frame/clear gl./cross bar			<b>G6 NEW SALON</b> 986 aluminium black, black glass 987 aluminium black, clear glass 989 aluminium matt, bronze-coloured black glass 990 aluminium matt, bronze-coloured clear glass			

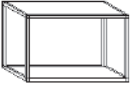
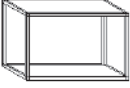
# Wall shelf units 39 cm high

Carcase depth 36.1 cm

			Decor groups										
Order no. W H D			Hinge side:	Carcase depth	M10	M20	M30	M40	M50	M60	M70	M80	M90
 <b>Wall shelf unit</b> wide in cm: 13-30 wide in cm: 30,1-40 wide in cm: 40,1-45 wide in cm: 45,1-50 wide in cm: 50,1-60 wide in cm: 60,1-80 wide in cm: 80,1-90		HR 30 39 36			138	-	-	-	412	-	412	412	-
		HR 40 39 36			138	-	-	-	412	-	412	412	-
		HR 45 39 36			138	-	-	-	412	-	412	412	-
		HR 50 39 36			138	-	-	-	412	-	412	412	-
		HR 60 39 36			138	-	-	-	412	-	412	412	-
		HR 80 39 36			146	-	-	-	464	-	723	723	-
		HR 90 39 36			146	-	-	-	464	-	723	723	-
<b>M 10</b>	<b>M 20</b>	<b>M 30</b>	<b>M 40</b>	<b>M 50</b>									
K M10 laminate					B M50 Velvet lacquer S M50 microstructure lacquer								
<b>M 60</b>	<b>M 70</b>	<b>M 80</b>	<b>M 90</b>										
	F M70 veneer / oak / walnut Z M70 Veneer / Bavaria	H M80 high gloss-Lacquer MP M80 laqué mat Premium											

# Smart Cube wall shelf unit 39 cm high



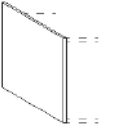

Carcase depth 25 cm

				Hinge side:	Carcase depth	Decor groups								
Order no.						M10	M20	M30	M40	M50	M60	M70	M80	M90
W H D														
 <p><b>Wall shelf unit Smart Cube</b> for hanging Finish: metal stainless steel-coloured Dimensions: height 39 cm, depth 25 cm Incl. 2 shelves 1.6 cm thick</p> <p>60 cm wide 90 cm wide 120 cm wide</p>														
				<b>HRDM 60 39 25</b>		391	410	-	-	498	-	553	-	-
				<b>HRDM 90 39 25</b>		439	466	-	-	599	-	705	-	-
			<b>HRDM120 39 25</b>		474	511	-	-	692	-	805	-	-	
 <p><b>Wall shelf unit Smart Cube</b> for hanging Finish: aluminium black Dimensions: height 39 cm, depth 25 cm Incl. 2 shelves 1.6 cm thick</p> <p>60 cm wide 90 cm wide 120 cm wide</p>														
				<b>HRDS 60 39 25</b>		391	410	-	-	498	-	553	-	-
				<b>HRDS 90 39 25</b>		439	466	-	-	599	-	705	-	-
			<b>HRDS120 39 25</b>		474	511	-	-	692	-	805	-	-	
<b>M 10</b>	<b>M 20</b>	<b>M 30</b>	<b>M 40</b>	<b>M 50</b>										
K M10 laminate	D M20 Laminate decor			B M50 Velvet Lacquer S M50 Microstructure Lacquer										
<b>M 60</b>	<b>M 70</b>	<b>M 80</b>	<b>M 90</b>											
	F M70 veneer / oak / walnut													





# Visible sides / increased side depth 39 cm high

Carcase depth 34 cm

				Hinge side:	Carcase depth	Decor groups								
Order no.						M10	M20	M30	M40	M50	M60	M70	M80	M90
W H D														
 <p><b>Wall unit visible side</b></p>				<b>HSV 39</b>	R/L	0	0	48	48	64	64	68	72	-
	 <b>Important!</b> Installation instead of a normal unit side.													
 <p><b>Wall unit increased side depth</b> Up to 57.5 cm side depth</p>				<b>HSVT 39</b>	R/L	57	65	103	103	138	138	143	145	-
	 <b>Important!</b> Installation instead of a normal unit side.													
<b>M 10</b>	<b>M 20</b>	<b>M 30</b>	<b>M 40</b>	<b>M 50</b>										
K M10 laminate	D M20 Laminate decor	I M30 RESOPAL PRO super matt IH M30 HPL PRO PW M30 PRIMEWOOD/Basic Veneer	A M40 DIRECTLACK matt L M40 DIRECTLACK high-gloss	B M50 Velvet lacquer P M50 Soft lacquer RH M50 Velvet lacquer wood texture RW M50 Velvet lacquer spackle effect S M50 microstructure lacquer										
<b>M 60</b>	<b>M 70</b>	<b>M 80</b>	<b>M 90</b>											
QH M60 SMARTGLAS high-gloss QM M60 SMARTGLAS satin-finish	F M70 veneer / oak / walnut V M70 Velvet lacquer textured Z M70 Veneer / Bavaria	C1 M80 FENIX stainless-steel look H M80 high gloss-Lacquer MP M80 laqué mat Premium O M80 Veneered												

# Background filler 39 cm high

Carcase depth 34 cm

		Order no. W H D		Hinge side:	Carcase depth	Decor groups								
						M10	M20	M30	M40	M50	M60	M70	M80	M90
	<b>Wall unit background filler</b> Width: 20 cm For fitting flush with carcase	<b>HPSL 00 39</b>				21,40	22,80	28,50	28,50	28,50	28,50	28,50	28,50	-
	<b>Wall unit side</b> without drill holes for panels e.g. at sides of cooker hoods etc. please state exact height	<b>HS</b>				39	129	176	233	234	244	244	244	-
<b>M 10</b>	<b>M 20</b>	<b>M 30</b>		<b>M 40</b>		<b>M 50</b>								
K M10 laminate	D M20 Laminate decor	I M30 RESOPAL PRO super matt IH M30 HPL PRO PW M30 PRIMEWOOD/Basic Veneeer		A M40 DIRECTLACK matt L M40 DIRECTLACK high-gloss		B M50 Velvet lacquer P M50 Soft lacquer S M50 microstructure lacquer								
<b>M 60</b>	<b>M 70</b>	<b>M 80</b>		<b>M 90</b>										
QH M60 SMARTGLAS high-gloss QM M60 SMARTGLAS satin-finish	F M70 veneer / oak / walnut Z M70 Veneer / Bavaria	C1 M80 FENIX stainless-steel look H M80 high gloss-Lacquer MP M80 laqué mat Premium												

# Additional equipment

Carcase depth 34 cm

		Order no. W H D		Hinge side:	Carcase depth	Decor groups								
						M10	M20	M30	M40	M50	M60	M70	M80	M90
	<b>Surcharge for wall cabinets with glass fronts inside and exterior in the same design</b> available in decor groups: S/B/H/MP/F/Z	<b>IDF-H</b>				-	-	-	-	495	-	495	495	-
<b>M 10</b>	<b>M 20</b>	<b>M 30</b>		<b>M 40</b>		<b>M 50</b>								
K M10 laminate						B M50 Velvet lacquer S M50 microstructure lacquer								
<b>M 60</b>	<b>M 70</b>	<b>M 80</b>		<b>M 90</b>										
	F M70 veneer / oak / walnut Z M70 Veneer / Bavaria	H M80 high gloss-Lacquer MP M80 laqué mat Premium												

# Front extension 39 cm high

Carcase depth 34 cm

	Order no. W H D	Hinge side:	Carcase depth	Price groups									
				1	2	3	4	5	6	7	8	9	
<p><b>Extra charge front extension</b> For wall unit doors Can be extended downwards by 5 cm Please note that twice the quantity is needed for 2-door units</p>				<b>FVHU 20</b>	46	49	51	72	98	100	109	120	-
				<b>FVHU 25</b>	46	49	51	72	98	100	109	120	-
				<b>FVHU 30</b>	46	49	51	72	98	100	109	120	-
				<b>FVHU 40</b>	49	50	52	76	105	112	121	133	-
				<b>FVHU 45</b>	50	51	53	78	109	114	123	135	-
				<b>FVHU 50</b>	51	52	54	83	113	120	131	144	-
				<b>FVHU 60</b>	53	54	59	87	118	133	144	158	-
				<p> <b>Not available for:</b> MIAMI, VIVA</p> <p> Only available for wall cabinets with hinged doors. The front will be delivered as a separate package. Wall units with glass doors, corner units, diagonal units or angled units are <b>not</b> available with front extension.</p>									
<p><b>Extra charge front extension</b> For wall unit doors can be extended upwards by maximum 18.5 cm Please note that twice the quantity is needed for 2-door units</p>				<b>FVHO 20</b>	46	49	51	72	98	100	109	120	-
				<b>FVHO 25</b>	46	49	51	72	98	100	109	120	-
				<b>FVHO 30</b>	46	49	51	72	98	100	109	120	-
				<b>FVHO 40</b>	49	50	52	76	105	112	121	133	-
				<b>FVHO 45</b>	50	51	53	78	109	114	123	135	-
				<b>FVHO 50</b>	51	52	54	83	113	120	131	144	-
				<b>FVHO 60</b>	53	54	59	87	118	133	144	158	-
				<p> <b>Not available for:</b> MIAMI, VIVA</p> <p> Only available for wall cabinets with hinged doors. The front will be delivered as a separate package. Wall units with glass doors, corner units, diagonal units or angled units are <b>not</b> available with front extension.</p>									
<p><b>Extra charge front extension</b> For wall unit doors Can be extended upwards and downwards can be extended upwards by maximum 18.5 cm Can be extended downwards by 5 cm Please note that twice the quantity is needed for 2-door units</p>				<b>FVHUO20</b>	89	96	101	144	195	200	216	238	-
				<b>FVHUO25</b>	89	96	101	144	195	200	216	238	-
				<b>FVHUO30</b>	89	96	101	144	195	200	216	238	-
				<b>FVHUO40</b>	96	99	103	155	209	224	241	265	-
				<b>FVHUO45</b>	99	101	107	159	216	228	246	271	-
				<b>FVHUO50</b>	101	103	109	165	226	239	262	288	-
				<b>FVHUO60</b>	107	109	118	175	234	264	290	319	-
				<p> <b>Not available for:</b> MIAMI, VIVA</p> <p> Only available for wall cabinets with hinged doors. The front will be delivered as a separate package. Wall units with glass doors, corner units, diagonal units or angled units are <b>not</b> available with front extension.</p>									
<p><b>Wall unit front filler with front extension</b> Can be extended upwards and downwards can be extended upwards by maximum 18.5 cm Can be extended downwards by 5 cm</p>				<b>HPFV 10 39</b>	90	93	99	139	164	166	180	198	-
				<b>HPFV 20 39</b>	99	102	109	156	182	184	202	222	-
				<p> <b>Not available for:</b> MIAMI, VIVA</p>									
<p><b>Wall unit with full-width bottom structural shelf</b> Requirement: - Wall units up to 100 cm width - Wall units up to 78 cm height - Standard carcass decors decor group K</p>				<b>MP-HDUK</b>	75								
				<p> <b>Not available for:</b> Corner wall units with side lengths 60 x 60 cm, 65 x 65 cm, 80 x 80 cm, 90 x 90 cm Wall units with roller shutter Bottom shelves with LED lighting system „UP&amp;DOWN“</p>									
<p><b>Extra charge for grip ledge on bottom shelf of wall units</b></p>				<b>MP-KBKL</b>	31								
				<p> cannot be featured in corner wall units, diagonal units, bevelled units</p>									

# 5.2

Heights  
52 cm / 65  
cm

## Wall units 52 cm / 65 cm high

Wall units 52 cm high	XL 5.2.2-XL 5.2.3
Front filler 52 cm high	XL 5.2.3-XL 5.2.4
Extractor hood wall units 52 cm high	XL 5.2.4-XL 5.2.5
Wall units 52 cm high with glass fronts model-specific	XL 5.2.5-XL 5.2.6
Wall units 52 cm high with glass fronts neutral	XL 5.2.6-XL 5.2.7
Wall shelf units 52 cm high	XL 5.2.7-XL 5.2.8
Container	XL 5.2.8
Background filler 52 cm high	XL 5.2.9
Visible sides / increased side depth 52 cm high	XL 5.2.9
Additional equipment	XL 5.2.9
Front extension 52 cm high	XL 5.2.10
Wall units 65 cm high	XL 5.2.11-XL 5.2.12
Front filler 65 cm high	XL 5.2.12-XL 5.2.13
Extractor hood wall units 65 cm high	XL 5.2.13-XL 5.2.14
Wall units 65 cm high with glass fronts model-specific	XL 5.2.14-XL 5.2.15
Wall units 65 cm high with glass fronts neutral	XL 5.2.15-XL 5.2.16
Additional equipment	XL 5.2.17
Corner wall units 65 cm high	XL 5.2.17-XL 5.2.18
Wall shelf units 65 cm high	XL 5.2.18-XL 5.2.20
Container	XL 5.2.20
Wall shelf units 65 cm high Country-house elements	XL 5.2.20
Background filler 65 cm high	XL 5.2.21
Visible sides / increased side depth 65 cm high	XL 5.2.21
Front extension 65 cm high	XL 5.2.22

### Legend:



Available with grip ledge N...



Not available with grip ledge N...



This symbol indicates which models are available



This symbol indicates which models are not available



Planning advice



Heights  
52 cm / 65  
cm

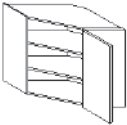
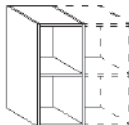
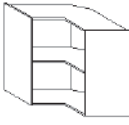
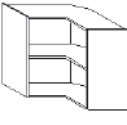

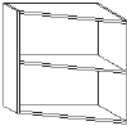
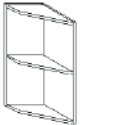
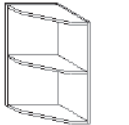


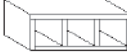

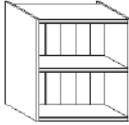


# The most important wall unit models 52 cm high

Page XL 5.2.2	Page XL 5.2.2	Page XL 5.2.2	Page XL 5.2.2	Page XL 5.2.2	Page XL 5.2.2	Page XL 5.2.2	Page XL 5.2.2	Page XL 5.2.2
H..523470 Unit widths: 30/40/45/50/60	H..523470 Unit widths: 80/90/100	H..523472 Unit widths: 30/40/45/50/60	H..523472 Unit widths: 80/90/100	H..523478 Unit widths: 30/40/45/50/60 80/90/100	HS..523470 Unit widths: 25	HF..523475 Unit widths: 60	HL..523478 Unit widths: 45/50/60/ 80/90/100	HL..0523478 Unit widths: 120
Page XL 5.2.3	Page XL 5.2.3	Page XL 5.2.3	Page XL 5.2.3	Page XL 5.2.3	Page XL 5.2.3	Page XL 5.2.4	Page XL 5.2.4	Page XL 5.2.4
H..523476 Unit widths: 30/40/45/50/60	H..523477 Unit widths: 30/40/45/50/60	H..523464 Unit widths: 80/90	HFL..523468 Unit widths: 45/50/60/ 80/90/100	HPR..521070 Unit widths: 30/40/45/50/60	HP..52 Unit widths: 3,5-20	HPW..52 Unit widths: 60X60	HAE..34 Unit widths: 4,8	HD..523478 Unit widths: 60
Page XL 5.2.4	Page XL 5.2.4	Page XL 5.2.4	Page XL 5.2.4	Page XL 5.2.4	Page XL 5.2.4	Page XL 5.2.5	Page XL 5.2.5	Page XL 5.2.5
HDT..52 Unit widths: 60	HDI..5234 Unit widths: 45/60	HDI..52341 Unit widths: 60	HDI..5234 Unit widths: 90	HDI..5234X Unit widths: 90/100/120	HM..523485 Unit widths: 50/60	HLDI..5234X Unit widths: 90	HFLMG..5234 Unit widths: 60/90	HFLG..5234 Unit widths: 60/90
Page XL 5.2.5	Page XL 5.2.6	Page XL 5.2.6	Page XL 5.2.6	Page XL 5.2.6	Page XL 5.2.7	Page XL 5.2.7	Page XL 5.2.7	Page XL 5.2.7
HFLMD..5234 Unit widths: 45/50/60/ 80/90/100	HFLMDA..5234 Unit widths: 60/80/90/100	HGD..523470 Unit widths: 45/50/60	HGLD..5234 Unit widths: 45/50/60/ 80/90/100	HFLD..5234 Unit widths: 45/50/60/ 80/90/100	HGLDA..5234 Unit widths: 60/80/90/100	HFLDA..5234 Unit widths: 60/80/90/100	HR..5236 Unit widths: 30/40/45/50/60 80/90	HRA255236 Unit widths: 25
Page XL 5.2.7	Page XL 5.2.8	Page XL 5.2.8						
HRA345236 Unit widths: 34	SR..1317 Unit widths: 37	HRSK..5236 Unit widths: 15						

# The most important wall unit models 65 cm high

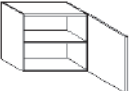
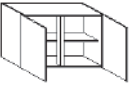
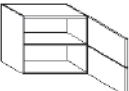
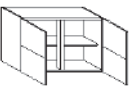
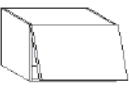
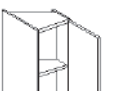

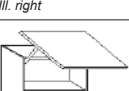
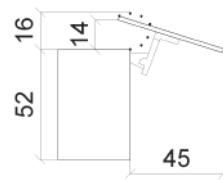
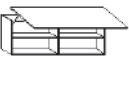
Page XL 5.2.11	Page XL 5.2.11	Page XL 5.2.11	Page XL 5.2.11	Page XL 5.2.11	Page XL 5.2.11	Page XL 5.2.11	Page XL 5.2.12	Page XL 5.2.12
H..653470	H..653470	H..6534702	HS..653470	HF..653475	H..653476	H..653477	HL..653478	HL..653476
Unit widths: 20/25/30/40/ 45/50/60	Unit widths: 80/90/100	Unit widths: 80/90/100	Unit widths: 25	Unit widths: 60	Unit widths: 30/40/45/50/60	Unit widths: 30/40/45/50/60	Unit widths: 45/50/60/ 80/90/100	Unit widths: 80
Page XL 5.2.12	Page XL 5.2.12	Page XL 5.2.12	Page XL 5.2.12	Page XL 5.2.12	Page XL 5.2.13	Page XL 5.2.13	Page XL 5.2.13	Page XL 5.2.13
HL..653478	HL..653478	HFL..653468	HPR..651070	HP..65	HPW..65	HEP..653485	HAE..34	HD..653470
Unit widths: 120	Unit widths: 160/180/200	Unit widths: 45/50/60/ 80/90/100	Unit widths: 30/40/45/50/60	Unit widths: 3,5-20	Unit widths: 60X60	Unit widths: 105x105	Unit widths: 4,8	Unit widths: 60
Page XL 5.2.13	Page XL 5.2.13	Page XL 5.2.13	Page XL 5.2.13	Page XL 5.2.13	Page XL 5.2.13	Page XL 5.2.14	Page XL 5.2.14	Page XL 5.2.14
HDT..65	HDI..6534	HDI..65341	HDI..6534	HDI..6534X	HLD..6534X	HM..653485	HG..6534RA	HG..6534RA
Unit widths: 60	Unit widths: 45/60	Unit widths: 60	Unit widths: 90	Unit widths: 90/100/120	Unit widths: 90	Unit widths: 50/60	Unit widths: 45/50/60	Unit widths: 90/100
Page XL 5.2.14	Page XL 5.2.14	Page XL 5.2.14	Page XL 5.2.14	Page XL 5.2.14	Page XL 5.2.14	Page XL 5.2.15	Page XL 5.2.15	Page XL 5.2.15
HG..6534LS	HG..6534LS	HG..6534SE	HG..6534SE	HG..6534LB	HG..6534LB	HGS..6534	HGS..6534	HGKS..6534
Unit widths: 45/50/60	Unit widths: 90/100	Unit widths: 45/50/60	Unit widths: 90/100	Unit widths: 45/50/60	Unit widths: 90/100	Unit widths: 45/50/60	Unit widths: 90/100	Unit widths: 45/50/60
Page XL 5.2.15	Page XL 5.2.15	Page XL 5.2.15	Page XL 5.2.15	Page XL 5.2.15	Page XL 5.2.16	Page XL 5.2.16	Page XL 5.2.16	Page XL 5.2.16
HGKS..6534	HGL..6534	HFLMD..6534	HGD..653470	HGD..653470	HGLD..6534	HGDA..653470	HGDA..653470	HGLDA..6534
Unit widths: 90/100	Unit widths: 45/50/60	Unit widths: 45/50/60/ 80/90/100	Unit widths: 45/50/60	Unit widths: 90/100	Unit widths: 45/50/60/ 80/90/100	Unit widths: 45/50/60	Unit widths: 90/100	Unit widths: 45/50/60/ 80/90/100
Page XL 5.2.16	Page XL 5.2.17	Page XL 5.2.17	Page XL 5.2.17	Page XL 5.2.17	Page XL 5.2.17	Page XL 5.2.18	Page XL 5.2.18	Page XL 5.2.18
HFLD..6534	HE..6534701	HE..6534701	HE..653475	HE..653475	HE..653475	HE..653475	HE..653475	HDE..6570
Unit widths: 45/50/60/ 80/90/100	Unit widths: 80/90	Unit widths: 80/90	Unit widths: 60x60	Unit widths: 65x65	Unit widths: 70x70	Unit widths: 80x80	Unit widths: 90x90	Unit widths: 60x60

# The most important wall unit models 65 cm high

Page XL 5.2.18	Page XL 5.2.18	Page XL 5.2.18	Page XL 5.2.19	Page XL 5.2.19	Page XL 5.2.19	Page XL 5.2.19	Page XL 5.2.19	Page XL 5.2.19	Page XL 5.2.19
									
<b>HDE..6570</b> Unit widths: 65x65	<b>HR..6536</b> Unit widths: 30/40/45/50/60 80/90	<b>HRE..6536</b> Unit widths: 60x60	<b>HRE..6536</b> Unit widths: 65x65	<b>HRS..6536</b> Unit widths: 25	<b>HRS..6536</b> Unit widths: 25	<b>HRA..6536</b> Unit widths: 25	<b>HRA..6536</b> Unit widths: 34	<b>HRE266536</b> Unit widths: 105x105	<b>HRE266536</b> Unit widths: 105x105
Page XL 5.2.19	Page XL 5.2.20	Page XL 5.2.20	Page XL 5.2.20	Page XL 5.2.20					
									
<b>SR..1317</b> Unit widths: 37	<b>HRSK..6536</b> Unit widths: 15	<b>HRL..6536</b> Unit widths: 30/45/60/90	<b>HRSL..6536</b> Unit widths: 30/45/60/90	<b>HRAL..6536</b> Unit widths: 40					

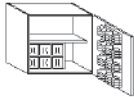
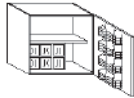


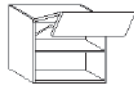
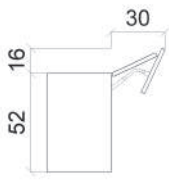
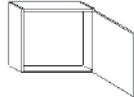
# Wall units 52 cm high

Carcase depth 34 cm


		Order no.	W H D				Hinge side:	Carcase depth	Price groups									
									1	2	3	4	5	6	7	8	9	
516		<b>Wall unit</b> 1 door 51.6 cm 1 adjustable shelf	H	30	52	34	70	R/L	125	133	146	182	208	217	236	260	-	
			H	40	52	34	70	R/L	125	133	146	182	208	217	236	260	-	
			H	45	52	34	70	R/L	125	133	146	182	211	222	245	270	-	
			H	50	52	34	70	R/L	125	133	146	182	216	227	251	276	-	
			H	60	52	34	70	R/L	141	147	166	220	254	263	294	323	-	
			H	70	52	34	70	R/L	172	182	188	319	363	377	416	458	-	
516		<b>Wall unit</b> 2 doors 51.6 cm 1 adjustable shelf	H	80	52	34	70		172	182	188	319	363	377	416	458	-	
			H	90	52	34	70		172	182	188	319	370	389	430	473	-	
			H	100	52	34	70		172	182	191	322	370	389	430	473	-	
256 256		<b>Wall unit</b> 1 door 51.6 cm consisting of 2 panels 25.6 cm attached 1 adjustable shelf	H	30	52	34	72	R/L	176	187	205	218	250	261	284	312	-	
			H	40	52	34	72	R/L	176	187	205	218	250	261	284	312	-	
			H	45	52	34	72	R/L	176	187	205	218	254	267	293	322	-	
			H	50	52	34	72	R/L	176	187	205	218	260	271	300	330	-	
			H	60	52	34	72	R/L	199	207	234	263	304	317	354	389	-	
256 256		<b>Wall unit</b> 2 doors 51.6 cm consisting of 2 panels 25.6 cm each, joined 1 adjustable shelf	H	80	52	34	72		244	255	261	381	435	455	498	548	-	
			H	90	52	34	72		244	255	261	381	443	466	516	568	-	
			H	100	52	34	72		244	255	265	385	443	466	516	568	-	
516		<b>Wall unit</b> 1 flap door 51.6 cm	<b>NEW</b>	H	30	52	34	78		253	260	284	323	340	350	359	394	-
				H	40	52	34	78		253	260	284	323	340	350	372	409	-
				H	45	52	34	78		253	260	284	323	340	350	372	409	-
				H	50	52	34	78		255	260	284	323	347	355	381	420	-
				H	60	52	34	78		262	269	291	335	354	366	393	433	-
				H	80	52	34	78		264	270	296	353	375	393	432	475	-
				H	90	52	34	78		264	270	296	353	375	393	432	475	-
				H	100	52	34	78		272	279	309	366	390	405	447	492	-
💡 <i>Planning advice:</i> height reduction not possible																		
516		<b>Wall unit angled by 37.2°</b> 25 cm wide 1 door 30 cm wide, 51.6 cm high 1 adjustable shelf For adjacent fitting left or right	HS	25	52	34	70	R/L	213	217	227	259	269	281	299	329	-	
516		<b>Wall unit with folding door</b> 1 sliding-folding door, 2-part, 51.6 cm 1 adjustable shelf	HF	60	52	34	75	R/L	217	229	255	317	364	373	410	451	-	
			💡 <i>Important!</i> Hinge right means drill hole for handle on left-hand side of right door.															
516		<b>Wall unit</b> 1 front 51.6 cm with lift-up fitting 1 adjustable shelf	HL	45	52	34	78		349	356	377	423	441	453	481	529	-	
			HL	50	52	34	78		349	356	377	423	446	460	484	532	-	
			HL	60	52	34	78		354	361	383	427	451	464	489	538	-	
			HL	80	52	34	78		418	427	462	533	584	607	646	711	-	
			HL	90	52	34	78		418	427	462	533	584	607	646	711	-	
			HL	100	52	34	78		427	438	476	545	602	622	661	727	-	
			✂️ <b>Width 45, 50, 60</b> <b>Width 80, 90, 100 Not available for: MIAMI, VIVA</b>															
💡 <i>Do not plan in conjunction with cornices and top covers!</i> Please observe a minimum distance of 17.5 cm between the top edge of the unit and the ceiling.																		
																		
516		<b>Wall unit</b> consisting of: 2 x 60 cm wide carcasses, overall carcase width 120 cm 1 full-width lifting door 51.6 cm high and 119.6 cm width with lift-up fitting, 2 adjustable shelves	HL	120	52	34	78		761	785	864	1039	1082	1117	1183	1301	-	
			✂️ <b>Not available for:</b> <b>BERGEN, FRAME, LUGANO, MIAMI, STRIP ELEMENTS, VIVA</b>															
💡 <i>Do not plan in conjunction with cornices and top covers!</i> Please observe a minimum distance of 17.5 cm between the top edge of the unit and the ceiling.																		

# Wall units 52 cm high

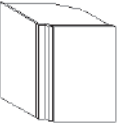
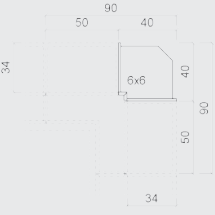
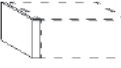
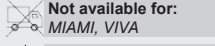
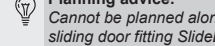

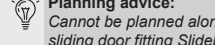
Carcase depth 34 cm

						Price groups										
		Order no.		Hinge side:	Carcase depth	1	2	3	4	5	6	7	8	9		
		W	H	D												
516	 <p><b>Wall unit with spices</b> 1 door 51.6 cm 6 containers 1 spice rack with 12 spice jars</p>	H	30	52	34	76	R/L	222	227	239	279	287	294	314	345	-
		H	40	52	34	76	R/L	239	246	269	307	325	334	360	396	-
		H	45	52	34	76	R/L	239	246	269	307	325	334	361	397	-
		H	50	52	34	76	R/L	239	246	269	307	325	334	361	397	-
		H	60	52	34	76	R/L	255	269	299	334	367	377	408	449	-
		Not available for: BERGEN, FRAME, LUGANO														
516	 <p><b>Wall unit</b> 1 door 51.6 cm 6 containers 1 spice rack WITHOUT spice jars</p>	H	30	52	34	77	R/L	183	188	205	239	251	258	279	307	-
		H	40	52	34	77	R/L	204	210	231	270	292	300	322	354	-
		H	45	52	34	77	R/L	204	210	231	270	292	300	322	354	-
		H	50	52	34	77	R/L	204	210	231	270	292	300	322	354	-
		H	60	52	34	77	R/L	217	231	261	299	330	343	370	407	-
		Not available for: BERGEN, FRAME, LUGANO														
256 256	 <p><b>Wall unit</b> 2 flap doors 25.6 cm one above the other 1 fixed shelf</p>	H	80	52	34	64		424	440	491	597	697	730	800	880	-
		H	90	52	34	64		424	440	491	597	697	730	800	880	-
516	 <p><b>Handle G 029</b> - optional - For on-site installation on the interior side of the lower front of folding-lifting-door wall units. Only possible with model-specific fronts (except FRAME and BERGEN, no glass fronts)</p>	G029					17,30									
256 256	 <p><b>Wall unit</b> 1 folding-lifting door with 2 fronts 25.6 cm 1 adjustable shelf</p>	HFL	45	52	34	68		372	378	434	533	625	663	713	784	-
		HFL	50	52	34	68		374	378	434	533	643	675	732	805	-
		HFL	60	52	34	68		381	395	445	555	660	694	765	842	-
		HFL	80	52	34	68		407	419	467	578	681	717	788	867	-
		HFL	90	52	34	68		407	419	467	578	681	717	788	867	-
		HFL	100	52	34	68		421	431	491	593	694	732	802	882	-
																
		SA50		BHFL			126									
516	 <p><b>Wall unit spacefitter frame</b> 1 door 51.6 cm Carcase depth 10 cm</p>	HPR	30	52	10	70	R/L	100	105	109	160	167	173	192	211	-
		HPR	40	52	10	70	R/L	100	105	109	160	167	173	192	211	-
		HPR	45	52	10	70	R/L	100	105	109	160	167	173	192	211	-
		HPR	50	52	10	70	R/L	116	120	124	172	180	187	209	230	-
		HPR	60	52	10	70	R/L	116	122	126	208	214	224	251	276	-

## Front filler 52 cm high

516	 <p><b>Wall unit front filler</b> 3.5 - 10 cm 11 - 20 cm</p>	HP	10	52			48	48	51	69	69	69	73	80	-		
		HP	20	52			56	56	60	86	86	86	95	105	-		
		HPZ		20		52			57	57	60	86	86	86	95	105	-
		Not available for: MIAMI, VIVA															

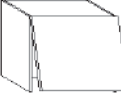
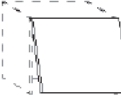
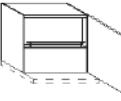
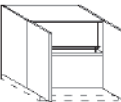
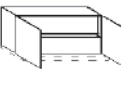
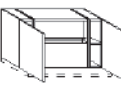

## Front filler 52 cm high

		Order no.		Price groups											
		W	H	D	Hinge side:	Carcase depth	1	2	3	4	5	6	7	8	9
516	 <p><b>Wall unit corner filler</b> 26 x 26 cm, with top and bottom shelf can be used instead of a 60 x 60 cm corner wall unit. Corner dimensions: from 6 x 6 cm (planning dimensions 40 x 40 cm) up to 26 x 26 cm (planning dimensions 60 x 60 cm) available</p>	<b>HPW</b>	<b>26</b>	<b>52</b>			251	263	311	390	390	411	447	492	-
															
516	 <p><b>Wall unit end panel</b> on one side Front material 4.8 cm wide, 51.6 cm high, depth 36.1 cm Intermediate sizes available at no extra charge</p>	<b>HAE</b>	<b>52</b>	<b>34</b>			267	275	301	332	370	370	392	431	-
		 <p><b>Not available for:</b> <i>MIAMI, VIVA</i></p>													
		 <p><b>Planning advice:</b> <i>Cannot be planned alongside cornices, light pelmets, sliding door fitting SlideLineM or extractor units</i></p>													
	 <p><b>Wall unit end panel</b> on one side Front material 4.8 cm wide, 51.6 cm high, depth 36.1 cm Intermediate sizes available at no extra charge</p>	<b>HAEG</b>	<b>52</b>	<b>34</b>			-	-	-	-	-	-	752	827	-
		 <p><b>Planning advice:</b> <i>Cannot be planned alongside cornices, light pelmets, sliding door fitting SlideLineM or extractor units</i></p>													

## Extractor hood wall units 52 cm high

Carcase depth 34 cm

Please indicate appliance type and manufacturer when ordering.

516	 <p><b>Wall unit for cooker hoods</b> For integrated cooker hoods 1 flap door 51.6 cm</p>	<b>HD</b>	<b>60</b>	<b>52</b>	<b>34</b>	<b>78</b>		190	204	236	283	283	295	325	358	-
516	 <p><b>Wall unit door, 51.6 cm high</b> as front panel for integrated cooker hoods</p>	<b>HDT</b>	<b>60</b>	<b>52</b>				75	84	100	165	178	186	214	235	-
516	 <p><b>Wall unit for cooker hoods</b> For integrated cooker hoods 1 door 51.6 cm 1 adjustable shelf with chrome-plated rail (number of adjustable shelves depends on appliance)</p>	<b>HDI</b>	<b>45</b>	<b>52</b>	<b>34</b>		R/L	224	229	246	298	329	341	369	406	-
		<b>HDI</b>	<b>60</b>	<b>52</b>	<b>34</b>		R/L	224	230	249	300	332	343	372	409	-
516	 <p><b>Wall unit for cooker hoods</b> For integrated cooker hoods 2 doors 51.6 cm 1 adjustable shelf with chrome-plated rail (number of adjustable shelves depends on appliance)</p>	<b>HDI</b>	<b>60</b>	<b>52</b>	<b>34</b>	<b>1</b>		257	267	271	400	451	474	512	563	-
516	 <p><b>Wall unit for cooker hoods</b> For integrated cooker hoods 2 doors 51.6 cm 1 adjustable shelf with chrome-plated rail (number of adjustable shelves depends on appliance)</p>	<b>HDI</b>	<b>90</b>	<b>52</b>	<b>34</b>			262	273	278	407	460	480	518	570	-
516	 <p><b>Wall unit for cooker hoods</b> For integrated cooker hoods 60 cm, with telescopic hood 90 cm wide 2 doors 51.6 cm 1 adjustable shelf with chrome-plated rail (number of adjustable shelves depends on appliance)</p>	<b>HDI</b>	<b>90</b>	<b>52</b>	<b>34</b>	<b>X</b>		522	531	536	658	710	728	770	847	-
		<b>HDI</b>	<b>100</b>	<b>52</b>	<b>34</b>	<b>X</b>		579	588	596	699	750	765	809	890	-
		<b>HDI</b>	<b>120</b>	<b>52</b>	<b>34</b>	<b>X</b>		619	629	635	737	790	803	849	934	-
	 <p><b>Wall unit</b> for microwave 1 panel or 1 flap door (depending on factory possibilities) 1 structural shelf 1 appliance aperture (height depending on appliance type)</p>	<b>HM</b>	<b>50</b>	<b>52</b>	<b>34</b>	<b>85</b>		148	156	172	210	239	252	271	298	-
		<b>HM</b>	<b>60</b>	<b>52</b>	<b>34</b>	<b>85</b>		162	171	190	239	275	288	314	345	-



# Extractor hood wall units 52 cm high

Carcase depth 34 cm

		Price groups										
Order no.	W H D	Hinge side:	Carcase depth	1	2	3	4	5	6	7	8	9
				516	HLDI 90 52 34 X			764	772	777	896	947
Not available for: MIAMI, VIVA												

Please indicate appliance type and manufacturer when ordering.

**516**  
  
**Wall unit for cooker hoods**  
 For integrated cooker hoods  
 60 cm, with telescopic hood 90 cm wide  
 1 front 51.6 cm with lift-up fitting  
 1 adjustable shelf with chrome-plated rail  
 (number of adjustable shelves depends on appliance)  
 1 adjustable shelf each left and right

## Wall units 52 cm high with glass fronts model-specific

Please indicate the desired glass type when ordering. 90 = clear glass 92 = matt glass 93 = black glass

**256**  
  
**Wall unit**  
 -model-specific-  
 1 folding-lifting door with front 25.6 cm at top and one glass front 25.6 cm at bottom  
 1 adjustable glass shelf

HFLMG60 52 34	453	467	522	628	731	769	835	919	-	
HFLMG90 52 34	482	495	548	653	758	790	862	948	-	
Available for: ARTE-B, ARTE-S, ATLANTA-B, ATLANTA-S, BERGEN, CASA-B, CASTELLO, CHALET-B, CHALET-S, CHICAGO, FRAME, LUGANO, LUX-B, MIAMI, NEW OPAL-M, NOBEL-B, NOBEL-S, OPAL-H, ORLANDO-B, ORLANDO-S, PALERMO-B, PALERMO-S, ROMA-B, ROMA-S, SIGNUM-B, SOFIE-B, SOFIE-S, VINO, VIVA, YORK-B, YORK-S										

**256**  
  
**Wall unit**  
 -model-specific-  
 1 folding-lifting door with glass front at top and bottom 25.6 cm

HFLG 60 52 34	525	540	596	701	803	843	905	996	-	
HFLG 90 52 34	559	576	629	730	832	865	936	1030	-	
Available for: ARTE-B, ARTE-S, ATLANTA-B, ATLANTA-S, BERGEN, CASA-B, CASTELLO, CHALET-B, CHALET-S, CHICAGO, FRAME, LUGANO, LUX-B, MIAMI, NEW OPAL-M, NOBEL-B, NOBEL-S, OPAL-H, ORLANDO-B, ORLANDO-S, PALERMO-B, PALERMO-S, ROMA-B, ROMA-S, SIGNUM-B, SOFIE-B, SOFIE-S, VINO, VIVA, YORK-B, YORK-S										

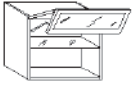
**256**  
  
**Wall unit**  
 -neutral- basis G2  
 1 folding-lifting door with front 25.6 cm at top and glass front 25.6 cm at bottom  
 1 adjustable glass shelf

HFLMD45 52 34	618	622	637	711	794	812	830	913	-	
extra charges for G5S	130	130	130	130	130	130	130	130	-	
HFLMD50 52 34	618	622	637	711	794	812	830	913	-	
extra charges for G5S	141	141	141	141	141	141	141	141	-	
HFLMD60 52 34	625	631	649	734	814	833	881	969	-	
extra charges for G5S	148	148	148	148	148	148	148	148	-	
HFLMD80 52 34	646	653	700	736	820	834	881	969	-	
extra charges for G5S	157	157	157	157	157	157	157	157	-	
HFLMD90 52 34	646	653	700	736	820	834	881	969	-	
extra charges for G5S	157	157	157	157	157	157	157	157	-	
HFLMD100 52 34	672	679	724	763	847	860	894	983	-	
extra charges for G5S	164	164	164	164	164	164	164	164	-	

# Wall units 52 cm high with glass fronts model-specific

Please indicate the desired glass type when ordering. 90 = clear glass 92 = matt glass 93 = black glass

256  
256



**Wall unit**  
-AktivGlas-  
1 folding-lifting door with front 25.6 cm at top and glass front 25.6 cm at bottom  
1 adjustable glass shelf

AKTIV  
GLAS

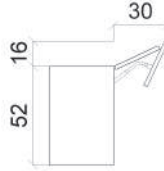
Order no.  
W H D

<b>HFLMDA60</b>	<b>52</b>	<b>34</b>
<b>HFLMDA80</b>	<b>52</b>	<b>34</b>
<b>HFLMDA90</b>	<b>52</b>	<b>34</b>



**Available glass versions:**  
991 = AktivGlas front - glass matt / frame stainless steel-coloured  
992 = AktivGlas front - black glass translucent, night black frame

Without drill hole for handle, knobs/handles not possible with grip ledge in bottom shelf

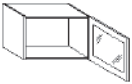


		Price groups								
		1	2	3	4	5	6	7	8	9
Hinge side:	Carcase depth	543	549	565	651	731	749	797	877	-
		562	570	617	653	737	750	797	877	-
		562	570	617	653	737	750	797	877	-

# Wall units 52 cm high with glass fronts neutral

Carcase depth 34 cm

516



**Wall unit with glass door**  
-neutral-  
1 glass door 51.6 cm

NEW

Order no.  
W H D

<b>HGD 45 52 34 70</b>	R/L
<b>HGD 50 52 34 70</b>	R/L
<b>HGD 60 52 34 70</b>	R/L

516

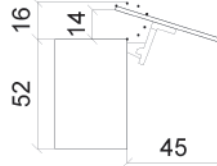


**Wall unit**  
-neutral-  
1 glass front 51.6 cm with lift-up fitting  
1 adjustable glass shelf

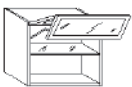
<b>HGLD 45 52 34</b>	-	641	-	-	-
<b>HGLD 50 52 34</b>	-	641	-	-	-
<b>HGLD 60 52 34</b>	-	653	-	-	-
<b>HGLD 80 52 34</b>	-	756	-	-	-
<b>HGLD 90 52 34</b>	-	770	-	-	-
<b>HGLD100 52 34</b>	-	797	-	-	-



Do not plan in conjunction with cornices and top covers!  
Please observe a minimum distance of 17.5 cm between the top edge of the unit and the ceiling.

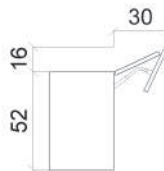


256  
256



**Wall unit**  
-neutral-  
1 folding-lifting door with 25.6 cm glass front at top and 25.6 cm glass front at bottom  
1 adjustable glass shelf



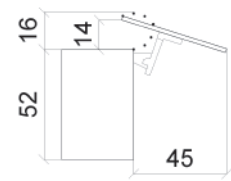
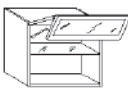

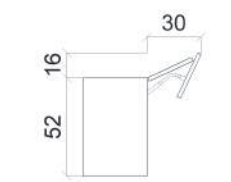
<b>HFLD 45 52 34</b>	-	783	-	-	-
<b>HFLD 50 52 34</b>	-	790	-	-	-
<b>HFLD 60 52 34</b>	-	825	-	-	-
<b>HFLD 80 52 34</b>	-	867	-	-	-
<b>HFLD 90 52 34</b>	-	879	-	-	-
<b>HFLD 100 52 34</b>	-	946	-	-	-



		Glass groups				
		G1	G2	G2S	G5S	G6
Hinge side:	Carcase depth	-	-	415	-	792
		-	-	438	-	815
		-	-	474	-	851
		-	641	-	-	-
		-	641	-	-	-
		-	653	-	-	-
		-	756	-	-	-
		-	770	-	-	-
		-	797	-	-	-
		-	783	-	-	-
		-	790	-	-	-
		-	825	-	-	-
		-	867	-	-	-
		-	879	-	-	-
		-	946	-	-	-


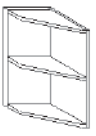

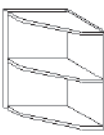
# Wall units 52 cm high with glass fronts neutral

Carcase depth 34 cm

			Glass groups																		
			Order no. W H D			Hinge side:	Carcase depth	G1	G2	G2S	G5S	G6									
516		<b>Wall unit</b> -neutral- 1 AktivGlas front 51.6 cm with lift-up fitting 1 adjustable glass shelf	AKTIV GLAS	HGLDA60	52	34			517	-	-	-	-								
				HGLDA80	52	34			585	-	-	-	-								
				HGLDA90	52	34			585	-	-	-	-								
				HGLDA100	52	34			598	-	-	-	-								
				 Without drill hole for handle, knobs/handles not possible with grip ledge in bottom shelf Do not plan in conjunction with cornices and top covers! Please observe a minimum distance of 17.5 cm between the top edge of the unit and the ceiling.																	
																					
256 256		<b>Wall unit</b> -neutral- 1 folding-lifting door with AktivGlas front 25.6 cm at top and AktiveGlas front 25.6 cm at bottom 1 adjustable glass shelf	AKTIV GLAS	HFLDA60	52	34			581	-	-	-	-								
				HFLDA80	52	34			596	-	-	-	-								
				HFLDA90	52	34			596	-	-	-	-								
				HFLDA100	52	34			628	-	-	-	-								
				 Without drill hole for handle, knobs/handles not possible with grip ledge in bottom shelf																	
																					
			G 1			G 2			G 2S			G 5			G 6						
<b>G1 AKTIVglass frame</b>			<b>G2 Design front</b>			<b>G2S aluminium, framed glass door</b>															
991 Matt glass 992 Translucent black glass			925 Frame White Agate/Matt glass 935 Premium W. Frame/Matt Glass 940 Macaron Col. Frame/Matt Glass 95 Light grey frame/matt glass 96 Silver Col. Frame/Matt Glass 960 Snow White Frame/Matt Glass 97 Black frame/black glass			988 aluminium black, Linea glass 994 Aluminium frame/clear glass 995 aluminium frame/black glass															
			G 5S			G 6															
			G5S aluminium, door with mullion 996 Alum.frame/clear gl./cross bar			G6 NEW SALON															
						986 aluminium black, black glass 987 aluminium black, clear glass 989 aluminium matt, bronze-coloured black glass 990 aluminium matt, bronze-coloured clear glass															

# Wall shelf units 52 cm high


Carcase depth 36.1 cm


			Decor groups														
			Order no. W H D			Hinge side:	Carcase depth	M10	M20	M30	M40	M50	M60	M70	M80	M90	
	<b>Wall shelf unit</b> 1 adjustable shelf wide in cm: 13-30 wide in cm: 30,1-40 wide in cm: 40,1-45 wide in cm: 45,1-50 wide in cm: 50,1-60 wide in cm: 60,1-80 wide in cm: 80,1-90		HR	30	52	36			137	-	-	-	498	-	498	498	-
			HR	40	52	36			137	-	-	-	498	-	498	498	-
			HR	45	52	36			137	-	-	-	498	-	498	498	-
			HR	50	52	36			137	-	-	-	498	-	498	498	-
			HR	60	52	36			137	-	-	-	498	-	498	498	-
			HR	80	52	36			164	-	-	-	563	-	803	803	-
			HR	90	52	36			164	-	-	-	563	-	803	803	-
				<b>Wall shelf end unit</b> 25 x 36.1 cm 1 fixed shelf For adjacent fitting left or right		HRA	25	52	36	R/L		155	-	-	-	339	-
 Important! Only available in 25 cm width.																	
	<b>Wall shelf end unit</b> 34 x 36.1 cm 1 fixed shelf For adjacent fitting left or right		HRA	34	52	36	R/L		155	-	-	-	389	-	389	389	-

# Wall shelf units 52 cm high

Carcase depth 36.1 cm

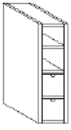
Order no.  
W H D

		Decor groups								
Hinge side:	Carcase depth	M10	M20	M30	M40	M50	M60	M70	M80	M90
		546	-	-	-	-	-	-	-	-
 Only in conjunction with carcase decor group K										



**Flour, sugar and rice scoops in carcase decors**  
including 3 lead-crystal scoops  
Capacity 750 ml, crystal clear  
for installing below wall units or  
for featuring in wall units  
Size (W x H x D) 36.8 x 13. x 17. cm

<b>SR</b>	<b>37</b>	<b>13</b>	<b>17</b>
-----------	-----------	-----------	-----------

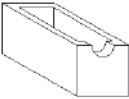


**Wall shelf unit for containers**  
15 cm wide,  
Prepared for 3 containers

<b>HRSK</b>	<b>15</b>	<b>52</b>	<b>36</b>
-------------	-----------	-----------	-----------

M 10	M 20	M 30	M 40	M 50
K M10 laminate				B M50 Velvet lacquer S M50 microstructure lacquer
M 60	M 70	M 80	M 90	
	F M70 veneer / oak / walnut Z M70 Veneer / Bavaria	H M80 high gloss-Lacquer MP M80 laqué mat Premium		

## Container





**Container, 11 cm high**  
for 15 cm wide shelf unit

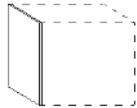



<b>SKH</b>	<b>15</b>	<b>13</b>								
------------	-----------	-----------	--	--	--	--	--	--	--	--

M 10	M 20	M 30	M 40	M 50
				B M50 Velvet Lacquer S M50 Microstructure Lacquer
M 60	M 70	M 80	M 90	
	F M70 veneer / oak / walnut			

# Background filler 52 cm high

				Decor groups										
		Order no. W H D		Hinge side:	Carcase depth	M10	M20	M30	M40	M50	M60	M70	M80	M90
	<b>Wall unit background filler</b> Width: 20 cm For fitting flush with carcass	<b>HPSL 00 52</b>				21,40	22,80	42	42	42	42	42	42	-
	<b>Wall unit side</b> without drill holes for panels e.g. at sides of cooker hoods etc. please state exact height	<b>HS</b>				39	129	176	233	234	244	244	244	-
<b>M 10</b>	<b>M 20</b>	<b>M 30</b>	<b>M 40</b>	<b>M 50</b>										
K M10 laminate	D M20 Laminate decor	I M30 RESOPAL PRO super matt IH M30 HPL PRO PW M30 PRIMEWOOD/Basic Veneer	A M40 DIRECTLACK matt L M40 DIRECTLACK high-gloss	B M50 Velvet lacquer P M50 Soft lacquer S M50 microstructure lacquer										
<b>M 60</b>	<b>M 70</b>	<b>M 80</b>	<b>M 90</b>											
QH M60 SMARTGLAS high-gloss QM M60 SMARTGLAS satin-finish	F M70 veneer / oak / walnut Z M70 Veneer / Bavaria	C1 M80 FENIX stainless-steel look H M80 high gloss-Lacquer MP M80 laqué mat Premium												

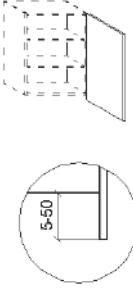


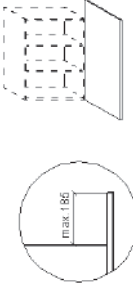


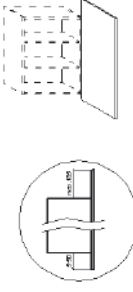


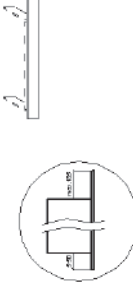

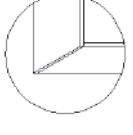



## Visible sides / increased side depth 52 cm high

	<b>Wall unit visible side</b>	<b>HSV 52</b>	R/L	0	0	49	49	65	65	71	75	-		
		 <b>Important!</b> Installation instead of a normal unit side.												
	<b>Wall unit increased side depth</b> Up to 57.5 cm side depth	<b>HSVT 52</b>	R/L	57	65	106	106	140	140	157	167	-		
		 <b>Important!</b> Installation instead of a normal unit side.												
<b>M 10</b>	<b>M 20</b>	<b>M 30</b>	<b>M 40</b>	<b>M 50</b>										
K M10 laminate	D M20 Laminate decor	I M30 RESOPAL PRO super matt IH M30 HPL PRO PW M30 PRIMEWOOD/Basic Veneer	A M40 DIRECTLACK matt L M40 DIRECTLACK high-gloss	B M50 Velvet lacquer P M50 Soft lacquer RH M50 Velvet lacquer wood texture RW M50 Velvet lacquer spackle effect S M50 microstructure lacquer										
<b>M 60</b>	<b>M 70</b>	<b>M 80</b>	<b>M 90</b>											
QH M60 SMARTGLAS high-gloss QM M60 SMARTGLAS satin-finish	F M70 veneer / oak / walnut V M70 Velvet lacquer textured Z M70 Veneer / Bavaria	C1 M80 FENIX stainless-steel look H M80 high gloss-Lacquer MP M80 laqué mat Premium O M80 Veneered												

## Additional equipment

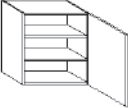

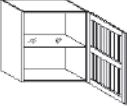


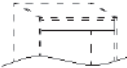

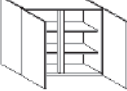








<b>Surcharge for wall cabinets with glass fronts inside and exterior in the same design</b> available in decor groups: S/B/H/MP/F/Z		<b>IDF-H</b>		-	-	-	-	495	-	495	495	-		
<b>M 10</b>	<b>M 20</b>	<b>M 30</b>	<b>M 40</b>	<b>M 50</b>										
K M10 laminate				B M50 Velvet lacquer S M50 microstructure lacquer										
<b>M 60</b>	<b>M 70</b>	<b>M 80</b>	<b>M 90</b>											
	F M70 veneer / oak / walnut Z M70 Veneer / Bavaria	H M80 high gloss-Lacquer MP M80 laqué mat Premium												

# Front extension 52 cm high

	Order no. W H D	Hinge side:	Carcase depth	Price groups									
				1	2	3	4	5	6	7	8	9	
 <p><b>Extra charge front extension</b> For wall unit doors Can be extended downwards by 5 cm Please note that twice the quantity is needed for 2-door units</p>				<b>FVHU 20</b>	46	49	51	72	98	100	109	120	-
				<b>FVHU 25</b>	46	49	51	72	98	100	109	120	-
				<b>FVHU 30</b>	46	49	51	72	98	100	109	120	-
				<b>FVHU 40</b>	49	50	52	76	105	112	121	133	-
				<b>FVHU 45</b>	50	51	53	78	109	114	123	135	-
				<b>FVHU 50</b>	51	52	54	83	113	120	131	144	-
				<b>FVHU 60</b>	53	54	59	87	118	133	144	158	-
				<p> <b>Not available for:</b> MIAMI, VIVA</p> <p> Only available for wall cabinets with hinged doors. The front will be delivered as a separate package. Wall units with glass doors, corner units, diagonal units or angled units are <b>not</b> available with front extension.</p>									
 <p><b>Extra charge front extension</b> For wall unit doors can be extended upwards by maximum 18.5 cm Please note that twice the quantity is needed for 2-door units</p>				<b>FVHO 20</b>	46	49	51	72	98	100	109	120	-
				<b>FVHO 25</b>	46	49	51	72	98	100	109	120	-
				<b>FVHO 30</b>	46	49	51	72	98	100	109	120	-
				<b>FVHO 40</b>	49	50	52	76	105	112	121	133	-
				<b>FVHO 45</b>	50	51	53	78	109	114	123	135	-
				<b>FVHO 50</b>	51	52	54	83	113	120	131	144	-
				<b>FVHO 60</b>	53	54	59	87	118	133	144	158	-
				<p> <b>Not available for:</b> MIAMI, VIVA</p> <p> Only available for wall cabinets with hinged doors. The front will be delivered as a separate package. Wall units with glass doors, corner units, diagonal units or angled units are <b>not</b> available with front extension.</p>									
 <p><b>Extra charge front extension</b> For wall unit doors Can be extended upwards and downwards can be extended upwards by maximum 18.5 cm Can be extended downwards by 5 cm Please note that twice the quantity is needed for 2-door units</p>				<b>FVHUO20</b>	89	96	101	144	195	200	216	238	-
				<b>FVHUO25</b>	89	96	101	144	195	200	216	238	-
				<b>FVHUO30</b>	89	96	101	144	195	200	216	238	-
				<b>FVHUO40</b>	96	99	103	155	209	224	241	265	-
				<b>FVHUO45</b>	99	101	107	159	216	228	246	271	-
				<b>FVHUO50</b>	101	103	109	165	226	239	262	288	-
				<b>FVHUO60</b>	107	109	118	175	234	264	290	319	-
				<p> <b>Not available for:</b> MIAMI, VIVA</p> <p> Only available for wall cabinets with hinged doors. The front will be delivered as a separate package. Wall units with glass doors, corner units, diagonal units or angled units are <b>not</b> available with front extension.</p>									
 <p><b>Wall unit front filler with front extension</b> Can be extended upwards and downwards can be extended upwards by maximum 18.5 cm Can be extended downwards by 5 cm</p>				<b>HPFV 10 52</b>	92	95	101	141	166	169	182	200	-
				<b>HPFV 20 52</b>	101	105	111	158	184	187	205	226	-
			<p> <b>Not available for:</b> MIAMI, VIVA</p>										
 <p><b>Wall unit with full-width bottom structural shelf</b> Requirement: - Wall units up to 100 cm width - Wall units up to 78 cm height - Standard carcass decors decor group K</p>				<b>MP-HDUK</b>	75								
				<p> <b>Not available for:</b> Corner wall units with side lengths 60 x 60 cm, 65 x 65 cm, 80 x 80 cm, 90 x 90 cm Wall units with roller shutter Bottom shelves with LED lighting system „UP&amp;DOWN“</p>									
 <p><b>Extra charge for grip ledge on bottom shelf of wall units</b></p>				<b>MP-KBKL</b>	31								
				<p> cannot be featured in corner wall units, diagonal units, bevelled units</p>									

# Wall units 65 cm high

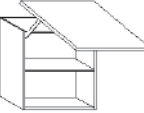
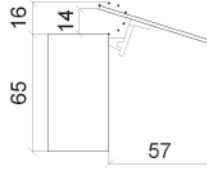
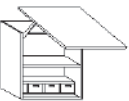

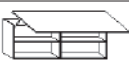




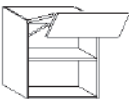


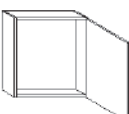



Carcase depth 34 cm

Order no.	W	H	D	Hinge side:	Carcase depth	Price groups																						
						1	2	3	4	5	6	7	8	9														
646		<b>Wall unit</b>		R/L	34																							
		1 door 64.6 cm																										
		2 adjustable shelves																										
		H	20 65 34 70																	128	136	147	186	202	204	218	240	-
		H	25 65 34 70																	128	136	147	186	202	204	218	240	-
		H	30 65 34 70																	128	136	147	186	202	204	218	240	-
		H	40 65 34 70																	145	149	172	211	233	246	268	295	-
H	45 65 34 70	145	149	172	211	233	246	268	295	-																		
H	50 65 34 70	156	164	183	226	252	263	293	322	-																		
H	60 65 34 70	175	187	208	262	298	301	332	365	-																		
H	70 65 34 70	191	205	245	343	393	412	451	496	-																		
 width 20 cm: <i>FRAME, VILLAGE 15-S, VILLAGE 15-B, CHALET-S, CHALET-B, OSLO 15, TESSIN 15, BERGEN, LUGANO, CASTELLO, VIVA, TIM 15</i> are supplied with smooth fronts. width 25 cm: <i>FRAME</i> are supplied with smooth fronts.																												
646		<b>Wall unit</b>		R/L	34															1027								
		1 door 64.6 cm																										
2 adjustable glass shelves																												
With „push to open“ fitting																												
 Available for: <i>STRIP ELEMENTS</i>																												
 Available finishes: 775 Ash black lacquered																												
646		<b>Cable compartment for on-site installation in wall units</b>			34																							
		below top shelf																										
		for accommodating electrical items such as converters, cables etc.																										
		Consisting of left-hand and right-hand sides and bottom shelf																										
Panel removable																												
With ventilation grille																												
KF	45										138																	
KF	50										138																	
KF	60										138																	
 Finish: decor group K Suitable for unit models with side-hung doors																												
646		<b>Wall unit</b>			34																							
		2 doors 64.6 cm																										
		2 adjustable shelves																										
H	80 65 34 70	191	205	245	343	393	412	451	496	-																		
H	90 65 34 70	191	205	245	343	402	422	467	514	-																		
H	100 65 34 70	217	227	257	370	430	446	490	539	-																		
646		<b>Wall unit</b>		R/L	34																							
		2 parallel hinged doors 64.6 cm																										
		2 adjustable shelves																										
H	80 65 34 702	215	229	268	368	416	437	479	527	-																		
H	90 65 34 702	215	229	268	368	424	444	488	537	-																		
H	100 65 34 702	240	252	278	395	449	474	516	568	-																		
646		<b>Wall unit angled by 37.2°</b>		R/L	34																							
		25 cm wide																										
1 door 30 cm wide, 64.6 cm high																												
2 adjustable shelves																												
For adjacent fitting left or right																												
HS	25 65 34 70	230	235	252	287	300	301	317	349	-																		
646		<b>Wall unit with folding door</b>		R/L	34																							
		1 sliding-folding door, 2-part, 64.6 cm																										
2 adjustable shelves																												
HF	60 65 34 75	252	267	295	363	407	410	447	492	-																		
 Important! Hinge right means drill hole for handle on left-hand side of right door.																												
646		<b>Wall unit with spices</b>		R/L	34																							
		1 door 64.6 cm																										
		6 containers																										
		1 spice rack with 12 spice jars																										
		H	30 65 34 76																			237	251	262	287	298	307	329
H	40 65 34 76	263	271	295	330	354	364	389	428	-																		
H	45 65 34 76	263	271	295	330	354	364	389	428	-																		
H	50 65 34 76	271	287	306	351	370	384	412	453	-																		
H	60 65 34 76	297	310	329	389	411	424	453	498	-																		
 Not available for: <i>BERGEN, FRAME, LUGANO</i>																												
646		<b>Wall unit</b>		R/L	34																							
		1 door 64.6 cm																										
		6 containers																										
		1 spice rack WITHOUT spice jars																										
		H	30 65 34 77																			204	214	227	252	260	270	293
H	40 65 34 77	227	236	258	294	317	325	356	392	-																		
H	45 65 34 77	227	236	258	294	317	325	356	392	-																		
H	50 65 34 77	236	251	267	312	332	351	374	411	-																		
H	60 65 34 77	259	271	295	356	374	386	419	461	-																		
 Not available for: <i>BERGEN, FRAME, LUGANO</i>																												



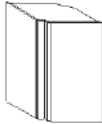
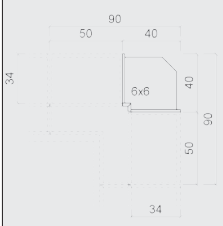


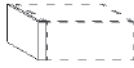


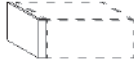

## Wall units 65 cm high

Carcase depth 34 cm

		Order no.	W H D				Hinge side:	Carcase depth	Price groups									
									1	2	3	4	5	6	7	8	9	
646	 <p><b>Wall unit</b> 1 front 64.6 cm with lift-up fitting 1 adjustable shelf</p>	HL	45	65	34	78			369	378	402	451	480	485	519	571	-	
		HL	50	65	34	78			369	378	402	451	485	490	524	576	-	
		HL	60	65	34	78			373	384	408	458	490	494	528	581	-	
		HL	80	65	34	78			432	446	487	580	638	657	701	771	-	
		HL	90	65	34	78			432	446	487	580	638	657	701	771	-	
		HL	100	65	34	78			442	460	498	596	653	675	719	791	-	
				Width 45, 50, 60 Width 80, 90, 100 Not available for: MIAMI, VIVA														
646	 <p><b>Wall unit</b> 1 front 64.6 cm with lift-up fitting 1 adjustable shelf 4 glass containers</p>	HL	80	65	34	76			802	816	856	940	996	1020	1062	1168	-	
		 Not available for: MIAMI, VIVA																
646	 <p><b>Wall unit</b> consisting of: 2 x 60 cm wide carcasses, overall carcase width 120 cm 1 full-width lifting door 64.6 cm high and 119.6 cm wide with lift-up fitting 2 adjustable shelves</p>	HL	120	65	34	78			761	785	864	1039	1082	1117	1183	1301	-	
		 Not available for: BERGEN, FRAME, LUGANO, MIAMI, STRIP ELEMENTS, VIVA Do not plan in conjunction with cornices or top covers. Please observe a minimum distance of 17.5 cm between the top edge of the unit and the ceiling.																
646	 <p><b>Wall unit</b> consisting of: Overall carcase width 160/180/200 cm 1 full-width lifting door 64.6 cm high and 159.6/179.6/199.6 cm width with lift-up fitting</p>		HL	160	65	34	78			903	933	1018	1214	1335	1378	1514	1665	-
		HL	180	65	34	78			909	939	1022	1219	1338	1383	1520	1672	-	
		HL	200	65	34	78			935	1005	1092	1302	1432	1478	1625	1788	-	
 Not available for: ALU TEC RP, ALUELEMENTS, ATLANTA-B, ATLANTA-S, BERGEN, CASTELLO, CHALET-B, CHALET-S, CHICAGO, FENIX INOX, FRAME, HPL PRO, INTARSIA, LUGANO, LUX-B, MIAMI, MON- TANA, MPX, NEVADA, NOBEL-B, NOBEL-S, ORLANDO-B, ORLANDO-S, PUR, RESOPAL PRO, RESOPAL PRO EDGE, RUSTY OAK, SMART-M, SOFIE-B, SOFIE-S, STRIP ELEMENTS, TALEA, TESSIN 15, TIM, TIM 15, VINO, VIVA, YORK-B, YORK-S Do not plan in conjunction with cornices or top covers. Please observe a minimum distance of 17.5 cm between the top edge of the unit and the ceiling. Available handles: from a drilling distance of 128 mm. The grip ledges N... are not available.																		
321 321	 <p><b>Wall unit</b> 1 folding-lifting door with 2 fronts 32.1 cm 1 adjustable shelf</p>	HFL	45	65	34	68			392	400	451	552	646	682	732	805	-	
		HFL	50	65	34	68			395	400	451	552	661	693	750	825	-	
		HFL	60	65	34	68			402	413	465	573	679	713	783	861	-	
		HFL	80	65	34	68			424	438	487	597	700	735	807	888	-	
		HFL	90	65	34	68			424	438	487	597	700	735	807	888	-	
		HFL	100	65	34	68			440	448	509	611	713	750	823	905	-	
 Not available for: MIAMI, VIVA																		
646	 <p><b>Handle G 029</b> - optional - For on-site installation on the interior side of the lower front of folding-lifting-door wall units. Only possible with model-specific fronts (except FRAME and BERGEN, no glass fronts)</p>	G029							17,30									
646	 <p><b>Wall unit spacefitter frame</b> 1 door 64.6 cm Carcase depth 10 cm</p>	HPR	30	65	10	70	R/L		116	120	125	186	193	207	226	249	-	
		HPR	40	65	10	70	R/L		116	120	125	186	193	207	226	249	-	
		HPR	45	65	10	70	R/L		116	120	125	186	193	207	226	249	-	
		HPR	50	65	10	70	R/L		136	139	145	204	211	222	245	270	-	
		HPR	60	65	10	70	R/L		136	141	147	244	252	260	293	322	-	
646	 <p><b>Wall unit front filler</b> 3.5 - 10 cm 11 - 20 cm</p>	HP	10	65						50	50	53	71	71	71	75	83	-
		HP	20	65						59	60	65	88	88	88	98	108	-
646	 <p><b>Wall unit intermediate filler</b> 3.5 - 20 cm</p>	HPZ	20	65						60	60	64	88	88	88	98	108	-
		 Not available for: MIAMI, VIVA																

## Front filler 65 cm high

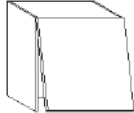
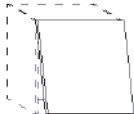
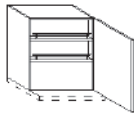
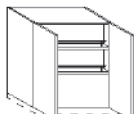
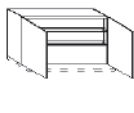
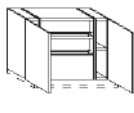
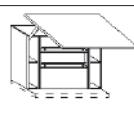


Carcase depth 34 cm

		Price groups									
		1	2	3	4	5	6	7	8	9	
646	 <p><b>Wall unit corner filler</b> 26 x 26 cm, with top and bottom shelf can be used instead of a 60 x 60 cm corner wall unit. Corner dimensions: available from 6 x 6 cm (planning dimension 40 x 40 cm) up to 26 x 26 cm (planning dimension 60 x 60 cm)</p>	Order no. W H D									
		<p><b>HPW 26 65</b></p> 	261	279	323	403	403	423	464	510	-
646	 <p><b>Wall unit corner solution</b> Blind-fitted doors This model is intended for corner solution 105 x 105 cm</p>	Order no. W H D									
		<p><b>HEP 26 65 34 85</b></p> <p> <b>Not available for:</b> ALU TEC RP</p>	120	124	141	178	178	178	193	212	-
646	 <p><b>Wall unit end panel</b> on one side Front material 4.8 cm wide, 64.6 cm high, depth 36.1 cm Intermediate sizes available at no extra charge</p>	Order no. W H D									
		<p><b>HAE 65 34</b></p> <p> <b>Not available for:</b> MIAMI, VIVA</p> <p> <b>Planning advice:</b> Cannot be planned alongside cornices, light pelmets, sliding door fitting SlideLineM or extractor units</p>	292	299	332	369	411	411	437	481	-
646	 <p><b>Wall unit end panel</b> on one side Front material 4.8 cm wide, 64.6 cm high, depth 36.1 cm Intermediate sizes available at no extra charge</p>	Order no. W H D									
		<p><b>HAEG 65 34</b></p> <p> <b>Planning advice:</b> Cannot be planned alongside cornices, light pelmets, sliding door fitting SlideLineM or extractor units</p>	-	-	-	-	-	-	765	842	-

## Extractor hood wall units 65 cm high

Carcase depth 34 cm

Please indicate appliance type and manufacturer when ordering.

646	 <p><b>Wall unit for cooker hoods</b> For integrated cooker hoods 1 flap door 64.6 cm</p>	Order no. W H D										
		<p><b>HD 60 65 34 70</b></p>	190	204	236	283	283	295	325	358	-	
646	 <p><b>Wall unit door, 64.6 cm high</b> as front panel for integrated cooker hoods</p>	Order no. W H D										
		<p><b>HDT 60 65</b></p>	75	84	100	165	178	186	214	235	-	
646	 <p><b>Wall unit for cooker hoods</b> For integrated cooker hoods 1 door 64.6 cm 2 adjustable shelves with chrome-plated rail (number of adjustable shelves depends on appliance)</p>	Order no. W H D	R/L									
		<p><b>HDI 45 65 34</b></p>	258	267	283	339	373	375	410	451	-	
646	 <p><b>Wall unit for cooker hoods</b> For integrated cooker hoods 2 doors 64.6 cm 2 adjustable shelves with chrome-plated rail (number of adjustable shelves depends on appliance)</p>	Order no. W H D	R/L									
		<p><b>HDI 60 65 34</b></p>	258	268	287	342	375	379	414	455	-	
646	 <p><b>Wall unit for cooker hoods</b> For integrated cooker hoods 2 doors 64.6 cm 2 adjustable shelves with chrome-plated rail (number of adjustable shelves depends on appliance)</p>	Order no. W H D										
		<p><b>HDI 60 65 34 1</b></p>	275	286	328	424	484	502	547	602	-	
646	 <p><b>Wall unit for cooker hoods</b> For integrated cooker hoods 2 doors 64.6 cm 2 adjustable shelves with chrome-plated rail (number of adjustable shelves depends on appliance)</p>	Order no. W H D										
		<p><b>HDI 90 65 34</b></p>	280	293	334	431	490	508	553	608	-	
646	 <p><b>Wall unit for cooker hoods</b> For integrated cooker hoods 60 cm, with telescopic hood 90 cm wide 2 doors 64.6 cm 2 adjustable shelves with chrome-plated rail (number of adjustable shelves depends on appliance)</p>	Order no. W H D										
		<p><b>HDI 90 65 34 X</b></p>	538	553	593	685	742	763	805	886	-	
		<p><b>HDI 100 65 34 X</b></p>	599	615	643	723	785	800	847	932	-	
646	 <p><b>Wall unit for cooker hoods</b> For integrated cooker hoods 60 cm, with telescopic hood 90 cm wide 1 front 64.6 cm with lift-up fitting 2 adjustable shelves with chrome-plated rail (number of adjustable shelves depends on appliance) 1 adjustable shelf each left and right</p>	Order no. W H D										
		<p><b>HLDI 90 65 34 X</b></p> <p> <b>Not available for:</b> MIAMI, VIVA</p>	779	797	837	920	979	1002	1045	1150	-	

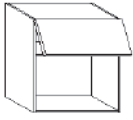
# Extractor hood wall units 65 cm high

Carcass depth 34 cm

Please indicate appliance type and manufacturer when ordering.

Order no.  
W H D

Hinge side:	Carcass depth	Price groups								
		1	2	3	4	5	6	7	8	9
		181	188	208	251	277	290	317	349	-
		198	213	230	290	322	324	360	396	-



**Wall unit**  
for microwave  
1 panel or 1 flap door (depending on factory possibilities)  
1 structural shelf  
1 appliance aperture  
(height depending on appliance type)

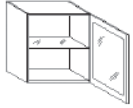
<b>HM</b>	<b>50</b>	<b>65</b>	<b>34</b>	<b>85</b>																
<b>HM</b>	<b>60</b>	<b>65</b>	<b>34</b>	<b>85</b>																

## Wall units 65 cm high with glass fronts model-specific

Carcass depth 34 cm

Please indicate the desired glass type when ordering. 90 = clear glass 92 = matt glass 93 = black glass

646

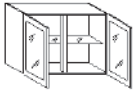


**Wall unit with glass door**  
-model-specific-  
1 Framed glass door 64,6 cm  
1 adjustable glass shelf

<b>HG</b>	<b>45</b>	<b>65</b>	<b>34</b>	<b>RA</b>	R/L	-	-	251	332	332	343	374	411	-
<b>HG</b>	<b>50</b>	<b>65</b>	<b>34</b>	<b>RA</b>	R/L	-	-	255	332	332	343	374	411	-
<b>HG</b>	<b>60</b>	<b>65</b>	<b>34</b>	<b>RA</b>	R/L	-	-	277	381	381	393	427	470	-

**Available for:**  
ARTE-B, ARTE-S, ATLANTA-B, ATLANTA-S, BERGEN, CASA-B, CASTELLO, CHALET-B, CHALET-S, CHICAGO, FRAME, LUGANO, LUX-B, MIAMI, NEW OPAL-M, NOBEL-B, NOBEL-S, OPAL-H, ORLANDO-B, ORLANDO-S, PALAZZO, PALERMO-B, PALERMO-S, ROMA-B, ROMA-S, SIGNUM-B, SOFIE-B, SOFIE-S, VINO, VIVA, YORK-B, YORK-S

646

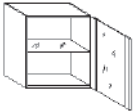


**Wall unit with glass door**  
-model-specific-  
2 Framed glass doors 64,6 cm  
1 adjustable glass shelf

<b>HG</b>	<b>90</b>	<b>65</b>	<b>34</b>	<b>RA</b>		-	-	384	582	582	602	656	722	-
<b>HG</b>	<b>100</b>	<b>65</b>	<b>34</b>	<b>RA</b>		-	-	398	582	582	602	656	722	-

**Available for:**  
ARTE-B, ARTE-S, ATLANTA-B, ATLANTA-S, BERGEN, CASA-B, CASTELLO, CHALET-B, CHALET-S, CHICAGO, FRAME, LUGANO, LUX-B, MIAMI, NEW OPAL-M, NOBEL-B, NOBEL-S, OPAL-H, ORLANDO-B, ORLANDO-S, PALAZZO, PALERMO-B, PALERMO-S, ROMA-B, ROMA-S, SIGNUM-B, SOFIE-B, SOFIE-S, VINO, VIVA, YORK-B, YORK-S

646

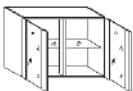


**Wall unit with glass door**  
-model-specific-  
2 semi-frameless glass doors 64.6 cm  
1 adjustable glass shelf

<b>HG</b>	<b>45</b>	<b>65</b>	<b>34</b>	<b>LS</b>	R/L	240	240	251	332	332	343	374	411	-
<b>HG</b>	<b>50</b>	<b>65</b>	<b>34</b>	<b>LS</b>	R/L	246	246	255	332	332	343	374	411	-
<b>HG</b>	<b>60</b>	<b>65</b>	<b>34</b>	<b>LS</b>	R/L	269	269	277	381	381	393	427	470	-

**Available for:**  
BAVARIA, EDITION, FENIX INOX, FLORENZ, GARDA, GENT, HPL PRO, MALMÖ, MODENA, MONTANA, MUNICH, NEVADA, OSLO 15, PADUA, PRIMEWOOD TOP, PUR, RESOPAL, RESOPAL PRO, RESOPAL PRO EDGE, RIVA, RUSTY OAK, SHERWOOD, SMART, SMART MIRROR, SMART-M, TESSIN 15, TIM, TIM 15, TOP, TREND, VILLAGE 15-B, VILLAGE 15-S

646

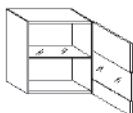


**Wall unit with glass door**  
-model-specific-  
2 semi-frameless glass doors 64.6 cm  
1 adjustable glass shelf

<b>HG</b>	<b>90</b>	<b>65</b>	<b>34</b>	<b>LS</b>		376	376	384	582	582	602	656	722	-
<b>HG</b>	<b>100</b>	<b>65</b>	<b>34</b>	<b>LS</b>		389	389	398	582	582	602	656	722	-

**Available for:**  
BAVARIA, EDITION, FENIX INOX, FLORENZ, GARDA, GENT, HPL PRO, MALMÖ, MODENA, MONTANA, MUNICH, NEVADA, OSLO 15, PADUA, PRIMEWOOD TOP, PUR, RESOPAL, RESOPAL PRO, RESOPAL PRO EDGE, RIVA, RUSTY OAK, SHERWOOD, SMART, SMART MIRROR, SMART-M, TESSIN 15, TIM, TIM 15, TOP, TREND, VILLAGE 15-B, VILLAGE 15-S

646

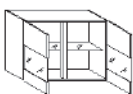


**Wall unit with glass door**  
-model-specific-  
1 segment glass door 64.6 cm  
1 adjustable glass shelf

<b>HG</b>	<b>45</b>	<b>65</b>	<b>34</b>	<b>SE</b>	R/L	271	271	281	365	365	373	408	449	-
<b>HG</b>	<b>50</b>	<b>65</b>	<b>34</b>	<b>SE</b>	R/L	277	277	287	365	365	373	408	449	-
<b>HG</b>	<b>60</b>	<b>65</b>	<b>34</b>	<b>SE</b>	R/L	301	301	308	414	414	424	460	506	-

**Available for:**  
EDITION, FENIX INOX, GARDA, HPL PRO, PRIMEWOOD TOP, PUR, RESOPAL, RESOPAL PRO, RESOPAL PRO EDGE, RIVA, SHERWOOD, SMART, SMART MIRROR, SMART-M, TOP, TREND

646

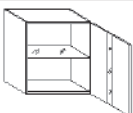


**Wall unit with glass door**  
-model-specific-  
2 segment glass doors 64.6 cm  
1 adjustable glass shelf

<b>HG</b>	<b>90</b>	<b>65</b>	<b>34</b>	<b>SE</b>		410	410	418	613	613	631	688	757	-
<b>HG</b>	<b>100</b>	<b>65</b>	<b>34</b>	<b>SE</b>		420	420	427	613	613	631	688	757	-

**Available for:**  
EDITION, FENIX INOX, GARDA, HPL PRO, PRIMEWOOD TOP, PUR, RESOPAL, RESOPAL PRO, RESOPAL PRO EDGE, RIVA, SHERWOOD, SMART, SMART MIRROR, SMART-M, TOP, TREND

646

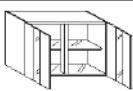


**Wall unit with glass door**  
-model-specific-  
1 semi-frameless glass door 64.6 cm  
Glass width 5 cm  
1 adjustable glass shelf

<b>HG</b>	<b>45</b>	<b>65</b>	<b>34</b>	<b>LB</b>	R/L	271	271	281	365	365	373	408	449	-
<b>HG</b>	<b>50</b>	<b>65</b>	<b>34</b>	<b>LB</b>	R/L	277	277	287	365	365	373	408	449	-
<b>HG</b>	<b>60</b>	<b>65</b>	<b>34</b>	<b>LB</b>	R/L	301	301	308	414	414	424	460	506	-

**Available for:**  
BAVARIA, EDITION, FENIX INOX, FLORENZ, GARDA, HPL PRO, MALMÖ, MODENA, MONTANA, MUNICH, NEVADA, PADUA, PRIMEWOOD TOP, PUR, RESOPAL, RESOPAL PRO, RESOPAL PRO EDGE, RIVA, RUSTY OAK, SHERWOOD, SMART, SMART MIRROR, SMART-M, TOP, TREND

646




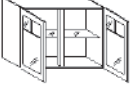
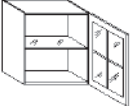
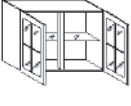


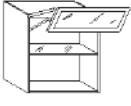
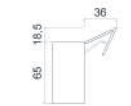
**Wall unit with glass door**  
-model-specific-  
2 semi-frameless glass doors 64.6 cm  
Glass width 5 cm  
1 adjustable glass shelf

<b>HG</b>	<b>90</b>	<b>65</b>	<b>34</b>	<b>LB</b>		410	410	418	613	613	631	688	757	-
<b>HG</b>	<b>100</b>	<b>65</b>	<b>34</b>	<b>LB</b>		420	420	427	613	613	631	688	757	-

**Available for:**  
BAVARIA, EDITION, FENIX INOX, FLORENZ, GARDA, HPL PRO, MALMÖ, MODENA, MONTANA, MUNICH, NEVADA, PADUA, PRIMEWOOD TOP, PUR, RESOPAL, RESOPAL PRO, RESOPAL PRO EDGE, RIVA, RUSTY OAK, SHERWOOD, SMART, SMART MIRROR, SMART-M, TOP, TREND

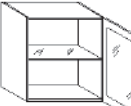
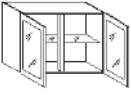
## Wall units 65 cm high with glass fronts model-specific

Carcase depth 34 cm

		Order no. W H D			Hinge side: Carcase depth	Price groups								
						1	2	3	4	5	6	7	8	9
646	 <p><b>Wall unit with glass door</b> -model-specific- 1 glass door 64.6 cm with mullions 1 adjustable glass shelf</p>	<b>HGS 45 65 34</b>	R/L	-	-	566	642	642	-	-	-	-	-	
		<b>HGS 50 65 34</b>	R/L	-	-	571	642	642	-	-	-	-	-	
		<b>HGS 60 65 34</b>	R/L	-	-	593	691	691	-	-	-	-	-	
		<p><b>Available for:</b> ARTE-B, ARTE-S, CHALET-B, CHALET-S, LUX-B, NOBEL-B, NOBEL-S, PALERMO-B, PALERMO-S, ROMA-B, ROMA-S, SOFIE-B, SOFIE-S, YORK-B, YORK-S</p> <p><b>Number of mullions/fields:</b> width 45 cm: 1 centre bar / 2 fields 13 cm x 13 cm each (W x H) width 50 cm: 1 centre bar / 2 fields 15.5 cm x 13 cm each (W x H) width 60 cm: 2 centre bars / 3 fields 13 cm x 13 cm each (W x H)</p>												
646	 <p><b>Wall unit with glass door</b> -model-specific- 2 glass doors 64.6 cm with mullions 1 adjustable glass shelf</p>	<b>HGS 90 65 34</b>		-	-	1018	1199	1199	-	-	-	-	-	
		<b>HGS 100 65 34</b>		-	-	1028	1199	1199	-	-	-	-	-	
		<p><b>Available for:</b> ARTE-B, ARTE-S, CHALET-B, CHALET-S, LUX-B, NOBEL-B, NOBEL-S, PALERMO-B, PALERMO-S, ROMA-B, ROMA-S, SOFIE-B, SOFIE-S, YORK-B, YORK-S</p> <p><b>Number of mullions/fields:</b> Width 45 cm: 1 centre bar / 2 fields 13 cm x 13 cm each (W x H) Width 50 cm: 1 centre bar / 2 fields 15.5 cm x 13 cm each (W x H)</p>												
646	 <p><b>Wall unit with glass door</b> -model-specific- 1 glass door 64.6 cm with crossbar 1 adjustable glass shelf</p>	<b>HGKS 45 65 34</b>	R/L	-	-	566	642	642	-	-	-	-	-	
		<b>HGKS 50 65 34</b>	R/L	-	-	571	642	642	-	-	-	-	-	
		<b>HGKS 60 65 34</b>	R/L	-	-	593	691	691	-	-	-	-	-	
		<p><b>Available for:</b> ARTE-B, ARTE-S, CHALET-B, CHALET-S, LUX-B, NOBEL-B, NOBEL-S, PALERMO-B, PALERMO-S, ROMA-B, ROMA-S, SOFIE-B, SOFIE-S, YORK-B, YORK-S</p>												
646	 <p><b>Wall unit with glass door</b> -model-specific- 2 glass doors 64.6 cm with crossbar 1 adjustable glass shelf</p>	<b>HGKS 90 65 34</b>		-	-	1018	1199	1199	-	-	-	-	-	
		<b>HGKS100 65 34</b>		-	-	1028	1199	1199	-	-	-	-	-	
		<p><b>Available for:</b> ARTE-B, ARTE-S, CHALET-B, CHALET-S, LUX-B, NOBEL-B, NOBEL-S, PALERMO-B, PALERMO-S, ROMA-B, ROMA-S, SOFIE-B, SOFIE-S, YORK-B, YORK-S</p>												
646	 <p><b>Wall unit with glass door</b> 1 glass door 64.6 cm Glass type: clear glass 1 adjustable glass shelf Visible side left or right in front finish with clear glass instead of normal carcass side Carcass inside and outside in micro textured lacquer or velvet lacquer</p> 	<b>HGL 45 65 34</b>	R/L	-	-	1039	1039	1039	-	-	-	-	-	
		<b>HGL 50 65 34</b>	R/L	-	-	1073	1073	1073	-	-	-	-	-	
		<b>HGL 60 65 34</b>	R/L	-	-	1140	1140	1140	-	-	-	-	-	
		<p><b>Available for:</b> ARTE-B, ARTE-S, CHALET-B, CHALET-S, LUX-B, NOBEL-B, NOBEL-S, PALERMO-B, PALERMO-S, ROMA-B, ROMA-S, SOFIE-B, SOFIE-S, YORK-B, YORK-S</p> <p><b>Door hinged left = door hinge and visible side in front finish left</b> <b>Door hinged right = door hinge and visible side in front finish right</b></p>												
321	 <p><b>Wall unit</b> -neutral- basis G2 1 folding-lifting door with front 32.1 cm at top and glass front 32.1 cm at bottom 1 adjustable glass shelf</p> 	<b>HFLMD45 65 34</b>		638	642	654	730	814	831	849	934	-	-	
		<i>extra charges for G5S</i>		130	130	130	130	130	130	130	130	130	-	-
		<b>HFLMD50 65 34</b>		638	642	654	730	814	831	849	934	-	-	-
		<i>extra charges for G5S</i>		141	141	141	141	141	141	141	141	141	-	-
		<b>HFLMD60 65 34</b>		646	651	667	752	833	852	900	990	-	-	-
		<i>extra charges for G5S</i>		148	148	148	148	148	148	148	148	148	-	-
		<b>HFLMD80 65 34</b>		664	672	719	756	840	853	900	990	-	-	-
		<i>extra charges for G5S</i>		157	157	157	157	157	157	157	157	157	-	-
		<b>HFLMD90 65 34</b>		664	672	719	756	840	853	900	990	-	-	-
		<i>extra charges for G5S</i>		157	157	157	157	157	157	157	157	157	-	-
<b>HFLMD100 65 34</b>		691	699	743	781	864	880	911	1002	-	-	-		
<i>extra charges for G5S</i>		164	164	164	164	164	164	164	164	164	-	-		

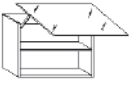
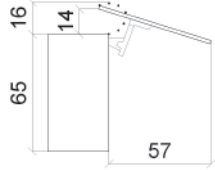

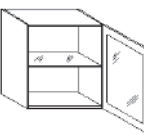

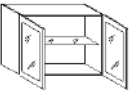



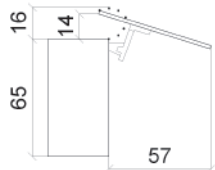
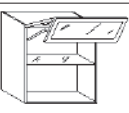
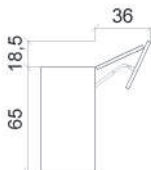
## Wall units 65 cm high with glass fronts neutral

Carcase depth 34 cm

		Order no. W H D			Hinge side: Carcase depth	Glass groups					
						G1	G2	G2S	G5S	G6	
646	 <p><b>Wall unit with glass door</b> -neutral- 1 glass door 64.6 cm 1 adjustable glass shelf</p>	<b>HGD 45 65 34 70</b>	R/L	-	442	442	499	826			
		<b>HGD 50 65 34 70</b>	R/L	-	473	473	530	857			
		<b>HGD 60 65 34 70</b>	R/L	-	515	515	587	899			
646	 <p><b>Wall unit with glass door</b> -neutral- 2 glass doors 64.6 cm 1 adjustable glass shelf</p>	<b>HGD 90 65 34 70</b>		-	772	772	864	1156			
		<b>HGD 100 65 34 70</b>		-	818	818	903	1202			

# Wall units 65 cm high with glass fronts neutral

Carcase depth 34 cm

		Order no.		Hinge side:	Carcase depth	Glass groups					
		W	H			D	G1	G2	G2S	G5S	G6
646	 <p><b>Wall unit</b> -neutral- 1 glass front 64.6 cm with lift-up fitting 1 adjustable glass shelf</p>		HGLD 45	65	34		-	657	-	-	-
			HGLD 50	65	34		-	664	-	-	-
			HGLD 60	65	34		-	690	-	-	-
			HGLD 80	65	34		-	736	-	-	-
			HGLD 90	65	34		-	744	-	-	-
			HGLD100	65	34		-	787	-	-	-
						<p> Do not plan in conjunction with cornices or top covers. Please observe a minimum distance of 17.5 cm between the top edge of the unit and the ceiling.</p>					
646	 <p><b>Wall unit with glass door</b> -neutral- 1 AktivGlas door 64.6 cm 1 adjustable glass shelf</p>	AKTIV GLAS	HGDA 45	65	34	70	R/L	335	-	-	-
			HGDA 50	65	34	70	R/L	354	-	-	-
			HGDA 60	65	34	70	R/L	377	-	-	-
		<p> <b>Planning advice:</b> Without drill hole for handle, knobs/handles not possible with grip ledge in bottom shelf</p>									
646	 <p><b>Wall unit with glass door</b> -neutral- 2 AktivGlas doors 64.6 cm Without centre panel 1 adjustable glass shelf</p>	AKTIV GLAS	HGDA 90	65	34	70		549	-	-	-
			HGDA100	65	34	70		576	-	-	-
		<p> <b>Planning advice:</b> Without drill hole for handle, knobs/handles not possible with grip ledge in bottom shelf</p>									
646	 <p><b>Wall unit</b> -neutral- 1 AktivGlas front 64.6 cm with lift-up fitting 1 adjustable glass shelf</p>	AKTIV GLAS	HGLDA45	65	34			535	-	-	-
			HGLDA50	65	34			545	-	-	-
			HGLDA60	65	34			560	-	-	-
			HGLDA80	65	34			585	-	-	-
			HGLDA90	65	34			585	-	-	-
			HGLDA100	65	34			598	-	-	-
		<p> <b>Planning advice:</b> Without drill hole for handle, knobs/handles not possible with grip ledge in bottom shelf Do not plan in conjunction with cornices or top covers. Please observe a minimum distance of 17.5 cm between the top edge of the unit and the ceiling.</p>									
											
321	 <p><b>Wall unit</b> 1 folding-lifting door with glass front 32.1 cm at top and G2 glass front 32.1 cm at bottom -neutral- 1 adjustable glass shelf</p>		HFLD 45	65	34			-	813	-	-
			HFLD 50	65	34			-	820	-	-
			HFLD 60	65	34			-	855	-	-
			HFLD 80	65	34			-	902	-	-
			HFLD 90	65	34			-	915	-	-
			HFLD100	65	34			-	985	-	-
											
		<b>G 1</b>	<b>G 2</b>			<b>G 2S</b>					
		<b>G1 AKTIVglass frame</b> 991 Matt glass 992 Translucent black glass	<b>G2 Design front</b> 925 Frame White Agate/Matt glass 935 Premium W. Frame/Matt Glass 940 Macaron Col. Frame/Matt Glass 95 Light grey frame/matt glass 96 Silver Col. Frame/Matt Glass 960 Snow White Frame/Matt Glass 97 Black frame/black glass			<b>G2S aluminium, framed glass door</b> 988 aluminium black, Linea glass 994 Aluminium frame/clear glass 995 aluminium frame/black glass					
		<b>G 5</b>	<b>G 5S</b>			<b>G 6</b>					
			G5S aluminium, door with mullion 996 Alum.frame/clear gl./cross bar			<b>G6 NEW SALON</b> 986 aluminium black, black glass 987 aluminium black, clear glass 989 aluminium matt, bronze-coloured black glass 990 aluminium matt, bronze-coloured clear glass					

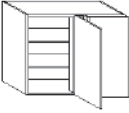
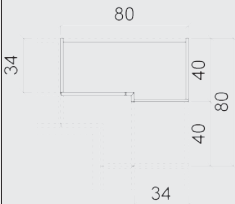
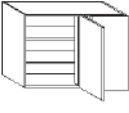
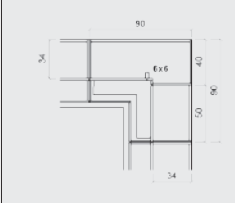
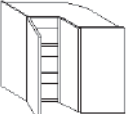

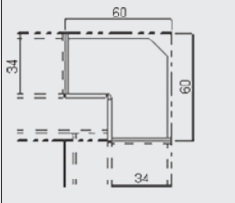

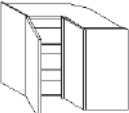

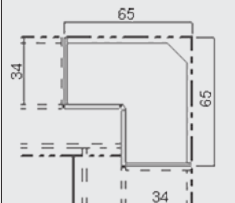

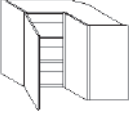

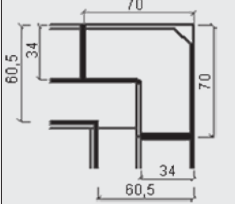

## Additional equipment

Carcase depth 34 cm

		Order no. W H D	Hinge side: Carcase depth	Price groups								
				M10	M20	M30	M40	M50	M60	M70	M80	M90
<b>Surcharge for wall cabinets with glass fronts inside and exterior in the same design</b> available in decor groups: S/B/H/MP/F/Z		<b>IDF-H</b>		-	-	-	-	495	-	495	495	-
<b>M 10</b> K M10 laminate		<b>M 20</b>	<b>M 30</b>	<b>M 40</b>	<b>M 50</b> B M50 Velvet lacquer S M50 microstructure lacquer							
<b>M 60</b>		<b>M 70</b> F M70 veneer / oak / walnut Z M70 Veneer / Bavaria	<b>M 80</b> H M80 high gloss-Lacquer MP M80 laqué mat Premium	<b>M 90</b>								

## Corner wall units 65 cm high

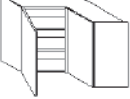
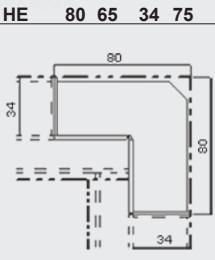

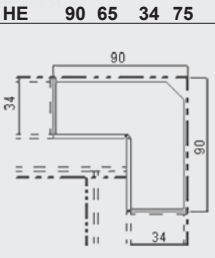
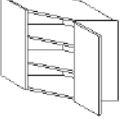
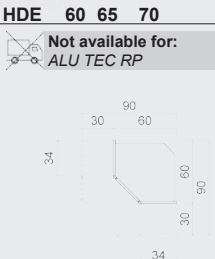
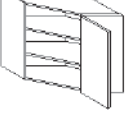
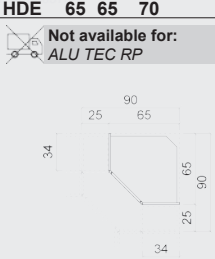
Carcase depth 34 cm

		Order no. W H D	Hinge side: Carcase depth	Price groups								
				1	2	3	4	5	6	7	8	9
646	 <p><b>Corner wall unit</b>                      80 cm wide, 1 door 64.6 cm (40 cm wide)                      2 adjustable shelves                      Blind section left or right</p>	<b>HE 80 65 34 701</b>	R/L	271	290	324	371	384	403	441	485	-
												
646	 <p><b>Corner wall unit</b>                      90 cm wide, 1 door 64.6 cm (50 cm wide)                      2 adjustable shelves                      Blind section left or right</p>	<b>HE 90 65 34 701</b>	R/L	271	290	324	371	384	403	441	485	-
												
646	 <p><b>Corner wall unit</b>                      side length 60 x 60 cm                      2 doors 64.6 cm (20 cm wide)                      Right door with corner angle 5.6 x 5.6 cm                      2 adjustable shelves</p>	 <b>HE 60 65 34 75</b>		280	297	345	403	412	431	477	525	-
		<p> <b>width 20 cm: FRAME, VILLAGE 15-S, VILLAGE 15-B, CHALET-S, CHALET-B, OSLO 15, TESSIN 15, BERGEN, LUGANO, CASTELLO, VIVA, TIM 15 are supplied with smooth fronts.</b></p>										
646	 <p><b>Corner wall unit</b>                      side length 65 x 65 cm                      2 doors 64.6 cm (25 cm wide)                      Right door with corner angle 5.6 x 5.6 cm                      2 adjustable shelves</p>	 <b>HE 65 65 34 75</b> <b>HE 65 65 34 75 PO</b>		341	359	410	465	476	489	535	589	-
		<p> <b>width 25 cm: FRAME are supplied with smooth fronts.</b></p>										
646	 <p><b>Corner wall unit</b>                      side length 70 x 70 cm                      2 doors 64.6 cm (30 cm wide)                      Right door with corner angle 5.6 x 5.6 cm                      2 adjustable shelves</p>	 <b>HE 70 65 34 75</b>		540	568	652	738	756	781	854	939	-
		<p> <b>For configurations with base unit carcass depth 60.5 cm and worktop depth 65 cm.</b></p>										



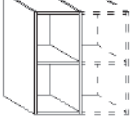
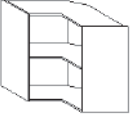
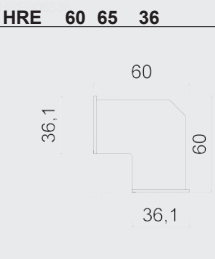
## Corner wall units 65 cm high

Carcase depth 34 cm

	Order no. W H D	Hinge side: Carcase depth	Price groups								
			1	2	3	4	5	6	7	8	9
<p>646 </p> <p><b>Corner wall unit</b> side length 80 x 80 cm 2 doors 64.6 cm (40 cm wide) Right door with corner angle 5.6 x 5.6 cm 2 adjustable shelves</p> 	<b>HE 80 65 34 75</b>		552	580	664	749	767	792	865	952	-
<p>646 </p> <p><b>Corner wall unit</b> side length 90 x 90 cm 2 doors 64.6 cm (50 cm wide) Right door with corner angle 5.6 x 5.6 cm 2 adjustable shelves</p> 	<b>HE 90 65 34 75</b>		576	605	691	784	800	827	904	994	-
<p>646 </p> <p><b>Diagonal corner wall unit</b> side length 60 x 60 cm 1 door 64.6 cm (30 cm wide) 2 adjustable shelves</p> 	<b>HDE 60 65 70</b>	R/L	316	322	341	375	402	411	436	480	-
<p><input checked="" type="checkbox"/> Not available for: <input checked="" type="checkbox"/> ALU TEC RP</p>											
<p>646 </p> <p><b>Diagonal corner wall unit</b> side length 65 x 65 cm 1 door 64.6 cm (40 cm wide) 2 adjustable shelves</p> 	<b>HDE 65 65 70</b>	R/L	316	322	341	375	402	411	436	480	-
<p><input checked="" type="checkbox"/> Not available for: <input checked="" type="checkbox"/> ALU TEC RP</p>											

## Wall shelf units 65 cm high

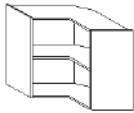
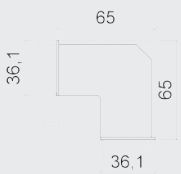
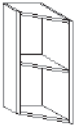




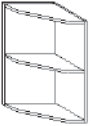
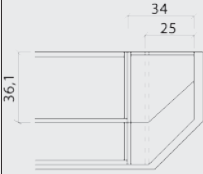


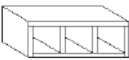

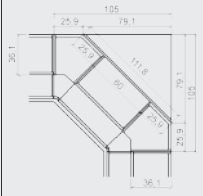
Carcase depth 36.1 cm

	Order no. W H D	Hinge side: Carcase depth	Decor groups								
			M10	M20	M30	M40	M50	M60	M70	M80	M90
<p></p> <p><b>Wall shelf unit</b> 1 adjustable shelf</p> <p>wide in cm: 13-30 wide in cm: 30,1-40 wide in cm: 40,1-45 wide in cm: 45,1-50 wide in cm: 50,1-60 wide in cm: 60,1-80 wide in cm: 80,1-90</p>	<b>HR 30 65 36</b>		163	-	-	-	549	-	549	549	-
	<b>HR 40 65 36</b>		163	-	-	-	549	-	549	549	-
	<b>HR 45 65 36</b>		163	-	-	-	549	-	549	549	-
	<b>HR 50 65 36</b>		163	-	-	-	549	-	549	549	-
	<b>HR 60 65 36</b>		163	-	-	-	549	-	549	549	-
	<b>HR 80 65 36</b>		181	-	-	-	621	-	860	860	-
	<b>HR 90 65 36</b>		181	-	-	-	621	-	860	860	-
	<p></p> <p><b>Corner wall shelf unit</b> Side length 60 x 60 cm 1 adjustable shelf</p> 	<b>HRE 60 65 36</b>		261	-	-	-	1029	-	1029	1029




# Wall shelf units 65 cm high

Carcase depth 36.1 cm

		Order no. W H D	Hinge side: Carcase depth	Decor groups								
				M10	M20	M30	M40	M50	M60	M70	M80	M90
	<b>Corner wall shelf unit</b> side length 65 x 65 cm 1 adjustable shelf	<b>HRE 65 65 36</b>		324	-	-	-	1121	-	1121	1121	-
												
	<b>Wall shelf unit angled by 37.2°</b> 25 cm wide 1 adjustable shelf For adjacent fitting left or right	<b>HRS 25 65 36</b>	R/L	192	-	-	-	523	-	523	523	-
	<b>Wall shelf unit 15-60 cm</b> Shelves angled at front 1 fixed shelf	<b>HRS 00 65 36</b>	R/L	231	-	-	-	717	-	717	717	-
		 <b>Important!</b> Please state right and left carcase depth (minimum depth 10 cm)										
	<b>Wall shelf end unit</b> 25 x 36.1 cm 1 fixed shelf For adjacent fitting left or right	<b>HRA 25 65 36</b>	R/L	172	-	-	-	378	-	378	378	-
		 <b>Important!</b> Only available in 25 cm width										
	<b>Wall shelf end unit</b> 34 x 36.1 cm 1 fixed shelf For adjacent fitting left or right	<b>HRA 34 65 36</b>	R/L	172	-	-	-	435	-	435	435	-
												
	<b>Wall unit corner solution</b> Spacefitter shelf unit 1 fixed shelf	<b>HRE 26 65 36</b>		141	-	-	-	491	-	-	-	-
		 <b>This model is intended for corner solution 105 x 105 cm</b>										
	<b>Flour, sugar and rice scoops in carcase decors</b> including 3 lead-crystal scoops Capacity 750 ml, crystal clear for installing below wall units or for featuring in wall units Size (W x H x D) 36.8 x 13. x 17. cm	<b>SR 37 13 17</b>		546	-	-	-	-	-	-	-	-
		 <b>Only in conjunction with carcase decor group K</b>										
												


## Wall shelf units 65 cm high

Carcase depth 36.1 cm

		Order no. W H D		Decor groups									
				M10	M20	M30	M40	M50	M60	M70	M80	M90	
	<b>Wall shelf unit for containers</b> 15 cm wide Prepared for 4 containers	<b>HRSK 15 65 36</b>			178	-	-	-	495	-	495	495	-
<b>M 10</b>	<b>M 20</b>	<b>M 30</b>	<b>M 40</b>	<b>M 50</b>	B M50 Velvet lacquer S M50 microstructure lacquer								
<b>M 60</b>	<b>M 70</b> F M70 veneer / oak / walnut Z M70 Veneer / Bavaria	<b>M 80</b> H M80 high gloss-Lacquer MP M80 laqué mat Premium	<b>M 90</b>										

## Container

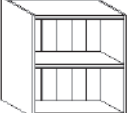


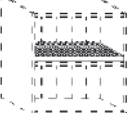


Carcase depth 34 cm

		Order no.		Decor groups									
				M10	M20	M30	M40	M50	M60	M70	M80	M90	
	<b>Container, 11 cm high</b> for 15 cm wide shelf unit	<b>SKH 15 13</b>			-	-	-	-	159	-	159	-	-
<b>M 10</b>	<b>M 20</b>	<b>M 30</b>	<b>M 40</b>	<b>M 50</b>	B M50 Velvet Lacquer S M50 Microstructure Lacquer								
<b>M 60</b>	<b>M 70</b> F M70 veneer / oak / walnut	<b>M 80</b>	<b>M 90</b>										

## Wall shelf units 65 cm high Country-house elements



Carcase depth 36.1 cm

fixed shelves 25 mm with profile at top and bottom

		Order no.		Decor groups										
				M10	M20	M30	M40	M50	M60	M70	M80	M90		
	<b>Wall shelf unit</b> Flush with front, depth 36.1 cm Grooved back panel 1 adjustable shelf	<b>HRL 30 65 36</b>			-	-	-	-	499	-	-	-	-	
					<b>HRL 45 65 36</b>	-	-	-	-	612	-	-	-	-
					<b>HRL 60 65 36</b>	-	-	-	-	747	-	-	-	-
					<b>HRL 90 65 36</b>	-	-	-	-	995	-	-	-	-
 	<b>Wall shelf unit with containers</b> Flush with front, depth 36.1 cm Grooved back panel 1 fixed shelf, 1 adjustable shelf 30 cm width: 1 container 45 cm width: 2 containers 60 cm width: 2 containers 90 cm width: 3 containers	<b>HRSL 30 65 36</b>			-	-	-	-	758	-	-	-	-	
					<b>HRSL 45 65 36</b>	-	-	-	-	1001	-	-	-	-
					<b>HRSL 60 65 36</b>	-	-	-	-	1121	-	-	-	-
					<b>HRSL 90 65 36</b>	-	-	-	-	1550	-	-	-	-
	<b>Plate rack insert</b> Suitable for shelf widths 45 cm 60 cm 90 cm				<b>TEL 45</b>	-	-	-	-	162	-	-	-	
					<b>TEL 60</b>	-	-	-	-	195	-	-	-	-
					<b>TEL 90</b>	-	-	-	-	236	-	-	-	-
 	<b>Wall shelf end unit</b> <b>With 1 pilaster at front with frieze</b> Width 40 cm, carcass depth 36.1 cm Flush with front Grooved back panel and side panel 1 fixed shelf	<b>HRAL 40 65 36</b>		R/L	-	-	-	-	731	-	-	-	-	
<b>M 10</b>	<b>M 20</b>	<b>M 30</b>	<b>M 40</b>	<b>M 50</b>	B M50 Velvet Lacquer S M50 Microstructure lacquer									
<b>M 60</b>	<b>M 70</b>	<b>M 80</b>	<b>M 90</b>											

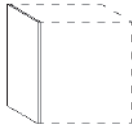



# Background filler 65 cm high

Carcase depth 34 cm

		Decor groups											
		Order no.	Hinge side:	Carcase depth	M10	M20	M30	M40	M50	M60	M70	M80	M90
		W H D											
	<b>Wall unit background filler</b> Width: 20 cm For fitting flush with carcass				<b>HPSL 00 65</b>	25,70	28,50	38	50	50	50	50	-
	<b>Wall unit side</b> without drill holes for panels e.g. at sides of cooker hoods etc. please state exact height				<b>HS</b>	39	129	176	233	234	244	244	-
<b>M 10</b>	<b>M 20</b>	<b>M 30</b>	<b>M 40</b>		<b>M 50</b>								
K M10 laminate	D M20 Laminate decor	I M30 RESOPAL PRO super matt IH M30 HPL PRO PW M30 PRIMEWOOD/Basic Veneer	A M40 DIRECTLACK matt L M40 DIRECTLACK high-gloss		B M50 Velvet lacquer P M50 Soft lacquer S M50 microstructure lacquer								
<b>M 60</b>	<b>M 70</b>	<b>M 80</b>	<b>M 90</b>										
QH M60 SMARTGLAS high-gloss QM M60 SMARTGLAS satin-finish	F M70 veneer / oak / walnut Z M70 Veneer / Bavaria	C1 M80 FENIX stainless-steel look H M80 high gloss-Lacquer MP M80 laqué mat Premium											

# Visible sides / increased side depth 65 cm high

Carcase depth 34 cm


		Decor groups												
		Order no.	Hinge side:	Carcase depth	M10	M20	M30	M40	M50	M60	M70	M80	M90	
	<b>Wall unit visible side</b>				<b>HSV 65</b>	0	0	49	49	66	66	73	91	-
		 <b>Important!</b> Installation instead of a normal unit side.												
	<b>Wall unit increased side depth</b> Up to 57.5 cm side depth				<b>HSV T 65</b>	57	65	109	109	144	144	161	201	-
		 <b>Important!</b> Installation instead of a normal unit side.												
<b>M 10</b>	<b>M 20</b>	<b>M 30</b>	<b>M 40</b>		<b>M 50</b>									
K M10 laminate	D M20 Laminate decor	I M30 RESOPAL PRO super matt IH M30 HPL PRO PW M30 PRIMEWOOD/Basic Veneer	A M40 DIRECTLACK matt L M40 DIRECTLACK high-gloss		B M50 Velvet lacquer P M50 Soft lacquer RH M50 Velvet lacquer wood texture RW M50 Velvet lacquer spackle effect S M50 microstructure lacquer									
<b>M 60</b>	<b>M 70</b>	<b>M 80</b>	<b>M 90</b>											
QH M60 SMARTGLAS high-gloss QM M60 SMARTGLAS satin-finish	F M70 veneer / oak / walnut V M70 Velvet lacquer textured Z M70 Veneer / Bavaria	C1 M80 FENIX stainless-steel look H M80 high gloss-Lacquer MP M80 laqué mat Premium O M80 Veneered												

# Front extension 65 cm high



Carcase depth 34 cm

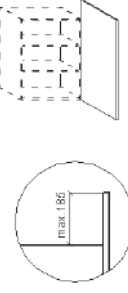
Order no.  
W H D

Hinge side:	Carcase depth	Price groups								
		1	2	3	4	5	6	7	8	9





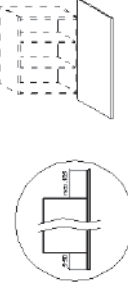
**Extra charge front extension**  
For wall unit doors  
Can be extended downwards by 5 cm  
Please note that twice the quantity is needed for 2-door units

<b>FVHU 20</b>	46	49	51	72	98	100	109	120	-
<b>FVHU 25</b>	46	49	51	72	98	100	109	120	-
<b>FVHU 30</b>	46	49	51	72	98	100	109	120	-
<b>FVHU 40</b>	49	50	52	76	105	112	121	133	-
<b>FVHU 45</b>	50	51	53	78	109	114	123	135	-
<b>FVHU 50</b>	51	52	54	83	113	120	131	144	-
<b>FVHU 60</b>	53	54	59	87	118	133	144	158	-
 <b>Not available for:</b> MIAMI, VIVA									
 Only available for wall cabinets with hinged doors. The front will be delivered as a separate package. Wall units with glass doors, corner units, diagonal units or angled units are <b>not</b> available with front extension.									






**Extra charge front extension**  
For wall unit doors  
can be extended upwards by maximum 18.5 cm  
Please note that twice the quantity is needed for 2-door units

<b>FVHO 20</b>	46	49	51	72	98	100	109	120	-
<b>FVHO 25</b>	46	49	51	72	98	100	109	120	-
<b>FVHO 30</b>	46	49	51	72	98	100	109	120	-
<b>FVHO 40</b>	49	50	52	76	105	112	121	133	-
<b>FVHO 45</b>	50	51	53	78	109	114	123	135	-
<b>FVHO 50</b>	51	52	54	83	113	120	131	144	-
<b>FVHO 60</b>	53	54	59	87	118	133	144	158	-
 <b>Not available for:</b> MIAMI, VIVA									
 Only available for wall cabinets with hinged doors. The front will be delivered as a separate package. Wall units with glass doors, corner units, diagonal units or angled units are <b>not</b> available with front extension.									




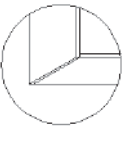
**Extra charge front extension**  
For wall unit doors  
Can be extended upwards and downwards  
can be extended upwards by maximum 18.5 cm  
Can be extended downwards by 5 cm  
Please note that twice the quantity is needed for 2-door units

<b>FVHUO20</b>	89	96	101	144	195	200	216	238	-
<b>FVHUO25</b>	89	96	101	144	195	200	216	238	-
<b>FVHUO30</b>	89	96	101	144	195	200	216	238	-
<b>FVHUO40</b>	96	99	103	155	209	224	241	265	-
<b>FVHUO45</b>	99	101	107	159	216	228	246	271	-
<b>FVHUO50</b>	101	103	109	165	226	239	262	288	-
<b>FVHUO60</b>	107	109	118	175	234	264	290	319	-
 <b>Not available for:</b> MIAMI, VIVA									
 Only available for wall cabinets with hinged doors. The front will be delivered as a separate package. Wall units with glass doors, corner units, diagonal units or angled units are <b>not</b> available with front extension.									





**Wall unit front filler with front extension**  
Can be extended upwards and downwards  
can be extended upwards by maximum 18.5 cm  
Can be extended downwards by 5 cm

<b>HPFV 10 65</b>	94	98	105	143	169	171	184	202	-
<b>HPFV 20 65</b>	103	109	116	160	187	189	207	228	-
 <b>Not available for:</b> MIAMI, VIVA									




**Wall unit with full-width bottom structural shelf**  
Requirement:  
- Wall units up to 100 cm width  
- Wall units up to 78 cm height  
- Standard carcass decors decor group K

<b>MP-HDUK</b>	75								
 <b>Not available for:</b> Corner wall units with side lengths 60 x 60 cm, 65 x 65 cm, 80 x 80 cm, 90 x 90 cm Wall units with roller shutter Bottom shelves with LED lighting system „UP&DOWN“									



**Extra charge for grip ledge on bottom shelf of wall units**

<b>MP-KBKL</b>	31								
 cannot be featured in corner wall units, diagonal units, bevelled units									

# 5.3

Height  
78 cm

## Wall units, 78 cm high

Wall units 78 cm high	XL 5.3.1-XL 5.3.2
Front filler 78 cm high	XL 5.3.2-XL 5.3.3
Extractor hood wall units 78 cm high	XL 5.3.3
Wall units, 78 cm high with glass fronts model-specific	XL 5.3.4-XL 5.3.6
Wall units 78 cm high with glass fronts neutral	XL 5.3.6-XL 5.3.7
Corner wall units 78 cm high	XL 5.3.7-XL 5.3.8
Wall shelf units 78 cm high	XL 5.3.9-XL 5.3.10
Container	XL 5.3.10
Wall shelf units 78 cm high Country-house elements	XL 5.3.10-XL 5.3.11
Smart Cube wall shelf unit 39 cm high / 78 cm high	XL 5.3.11
Panels 16 mm	XL 5.3.12
Panels 25 mm	XL 5.3.12
Smartframe wall shelf unit 78 cm high	XL 5.3.12
Background fillers 78 cm high	XL 5.3.12-XL 5.3.13
Visible sides / increased side depth 78 cm high	XL 5.3.13
Additional equipment	XL 5.3.13
Front extension 78 cm high	XL 5.3.14

### Legend:



Available with grip ledge N...



Not available with grip ledge N...



This symbol indicates which models are available



This symbol indicates which models are not available



Planning advice


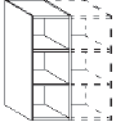
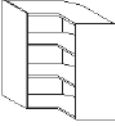
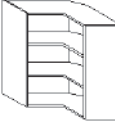



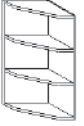

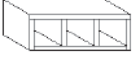

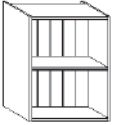
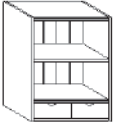


Height  
78 cm

# The most important wall unit models 78 cm high

Page XL 5.3.1	Page XL 5.3.1	Page XL 5.3.1	Page XL 5.3.1	Page XL 5.3.1	Page XL 5.3.1	Page XL 5.3.1	Page XL 5.3.1	Page XL 5.3.1
H..783470 Unit widths: 20/25/30/ 40/50/60	SEH..783470 Unit widths: 60	H..783470 Unit widths: 80/90/100	H..783472 Unit widths: 30/40/45/50/60	H..783472 Unit widths: 80/90/100	H..7834702 Unit widths: 80/90/100	HS..783470 Unit widths: 25	HF..783475 Unit widths: 60	H..783464 Unit widths: 60/80/90
Page XL 5.3.2	Page XL 5.3.2	Page XL 5.3.2	Page XL 5.3.2	Page XL 5.3.2	Page XL 5.3.2	Page XL 5.3.3	Page XL 5.3.3	Page XL 5.3.3
HFL..783468 Unit widths: 45/50/60/ 80/90/100	H..783476 Unit widths: 30/40/45/50/60	H..783477 Unit widths: 30/40/45/50/60	HPR..781070 Unit widths: 30/40/45/50/60	HP..78 Unit widths: 3,5-20	HPW::78 Unit widths: 60X60	HEP::783485 Unit widths: 105x105	HAE..34 Unit widths: 4,8	HDI..7834 Unit widths: 45/60
Page XL 5.3.3	Page XL 5.3.3	Page XL 5.3.3	Page XL 5.3.3	Page XL 5.3.3	Page XL 5.3.3	Page XL 5.3.4	Page XL 5.3.4	Page XL 5.3.4
HDI..78341 Unit widths: 60	HFLDI..7834X Unit widths: 90	HDI..7834 Unit widths: 90	HDI..7834X Unit widths: 90/100/120	HM..783470 Unit widths: 50/60	HM..783485 Unit widths: 50/60	HG..7834RA Unit widths: 45/50/60	HG..7834RA Unit widths: 90/100	HG..7834LS Unit widths: 45/50/60
Page XL 5.3.4	Page XL 5.3.4	Page XL 5.3.4	Page XL 5.3.4	Page XL 5.3.4	Page XL 5.3.4	Page XL 5.3.5	Page XL 5.3.5	Page XL 5.3.5
HG..7834LS Unit widths: 90/100	HG..7834SE Unit widths: 45/50/60	HG..7834SE Unit widths: 90/100	HG..7834LB Unit widths: 45/50/60	HG..7834LB Unit widths: 90/100	HGS..7834 Unit widths: 45/50/60	HGS..7834 Unit widths: 90/100	HGKS..7834 Unit widths: 45/50/60	HGKS..7834 Unit widths: 90/100
Page XL 5.3.5	Page XL 5.3.5	Page XL 5.3.5	Page XL 5.3.6	Page XL 5.3.6	Page XL 5.3.6	Page XL 5.3.6	Page XL 5.3.6	Page XL 5.3.7
HGL..7834 Unit widths: 45/50/60	HFLMG..7834 Unit widths: 60/90	HFLG..7834 Unit widths: 60/90	HFLMDA..7834 Unit widths: 60/80/90/100	HFLD..7834 Unit widths: 45/50/60/ 80/90/100	HGD..783470 Unit widths: 45/50/60	HGD..783470 Unit widths: 90/100	HGDA..783470 Unit widths: 45/50/60	HGDA..783470 Unit widths: 90/100
Page XL 5.3.7	Page XL 5.3.7	Page XL 5.3.7	Page XL 5.3.7	Page XL 5.3.8	Page XL 5.3.8	Page XL 5.3.8	Page XL 5.3.8	Page XL 5.3.8
HFLDA..7834 Unit widths: 60/80/90/100	HE..7834701 Unit widths: 80	HE..7834701 Unit widths: 90	HE..783475 Unit widths: 60x60	HE..783475 Unit widths: 65x65	HE..783475 Unit widths: 70x70	HE..783475 Unit widths: 80x80	HE..783475 Unit widths: 90x90	HDE..7870 Unit widths: 60x60

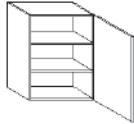

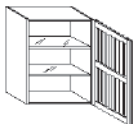


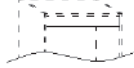

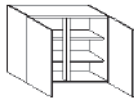
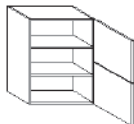
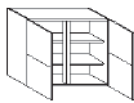
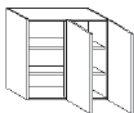
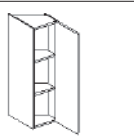


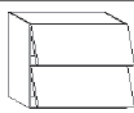


# The most important wall unit models 78 cm high

Page XL 5.3.8	Page XL 5.3.9	Page XL 5.3.9	Page XL 5.3.9	Page XL 5.3.9	Page XL 5.3.9	Page XL 5.3.9	Page XL 5.3.9	Page XL 5.3.10
								
HDE..7870 Unit widths: 65x65	HR..7836 Unit widths: 30/40/45/50/60	HRE..7836 Unit widths: 60x60	HRE..7836 Unit widths: 65x65	HRS..7836 Unit widths: 25	HRS..7836 Unit widths: 15-60	HRA..7836 Unit widths: 25	HRA..7836 Unit widths: 34	HRE..7836 Unit widths: 105x105
Page XL 5.3.10	Page XL 5.3.10	Page XL 5.3.10	Page XL 5.3.10	Page XL 5.3.11	Page XL 5.3.11			
								
SR..1317 Unit widths: 37	HRSK..7836 Unit widths: 15	HRL..7836 Unit widths: 30/45/60/90	HRSL..7836 Unit widths: 30/45/60/90	HRAL..7836 Unit widths: 40	Unit widths:			

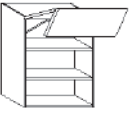
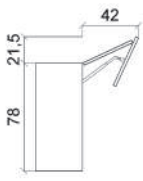




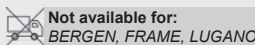
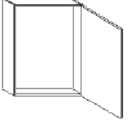
# Wall units 78 cm high

Carcase depth 34 cm


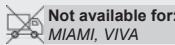
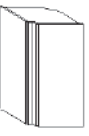
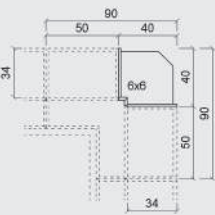
				Price groups												
		Order no.		Hinge side:	Carcase depth	1	2	3	4	5	6	7	8	9		
		W	H			D										
776	 <p><b>Wall unit</b> 1 door 77.6 cm 2 adjustable shelves</p>	H	20	78	34	70	R/L	146	149	165	264	271	287	317	349	-
		H	25	78	34	70	R/L	146	149	165	264	271	287	317	349	-
		H	30	78	34	70	R/L	146	149	165	264	271	287	317	349	-
		H	40	78	34	70	R/L	163	169	188	284	307	322	357	393	-
		H	45	78	34	70	R/L	163	169	188	292	317	330	365	402	-
		H	50	78	34	70	R/L	173	182	198	304	330	351	381	419	-
		H	60	78	34	70	R/L	192	205	226	349	377	399	438	482	-
		H	70	78	34	70	R/L	233	240	260	374	442	469	513	564	-
		 width 20 cm: <i>FRAME, VILLAGE 15-S, VILLAGE 15-B, CHALET-S, CHALET-B, OSLO 15, TESSIN 15, BERGEN, LUGANO, CASTELLO, VIVA, TIM 15</i> are supplied with smooth fronts. width 25 cm: <i>FRAME</i> are supplied with smooth fronts.														
776	 <p><b>Wall unit</b> 1 door 77.6 cm 2 adjustable glass shelves With „push to open“ fitting</p>	SE	H	60	78	34	70	R/L	-	-	-	-	-	-	-	1055
		 Available for: <i>STRIP ELEMENTS</i>  Available finishes: <i>775 Ash black lacquered</i>														
	 <p><b>Cable compartment for on-site installation in wall units</b> below top shelf for accommodating electrical items such as converters, cables etc. Consisting of left-hand and right-hand sides and bottom shelf Panel removable With ventilation grille</p>	KF	45													138
		KF	50													138
		KF	60													138
		 Finish: <i>decor group K</i> Suitable for unit models with side-hung doors														
776	 <p><b>Wall unit</b> 2 doors 77.6 cm 2 adjustable shelves</p>	H	80	78	34	70		233	240	260	374	442	469	513	564	-
		H	90	78	34	70		233	240	260	374	442	469	513	564	-
		H	100	78	34	70		260	263	269	403	474	490	541	595	-
386	 <p><b>Wall unit</b> 1 door 77.6 cm consisting of 2 panels 38.6 cm attached 2 adjustable shelves</p>	H	30	78	34	72	R/L	205	209	233	319	325	346	378	416	-
		H	40	78	34	72	R/L	229	237	261	341	369	385	427	470	-
		H	45	78	34	72	R/L	229	237	261	351	378	398	437	481	-
		H	50	78	34	72	R/L	245	255	277	366	398	420	460	506	-
		H	60	78	34	72	R/L	268	286	316	419	455	480	526	579	-
386	 <p><b>Wall unit</b> 2 doors 77.6 cm consisting of 2 panels 38.6 cm each, joined 2 adjustable shelves</p>	H	80	78	34	72		325	338	365	448	532	561	616	678	-
		H	90	78	34	72		325	338	365	448	532	561	616	678	-
		H	100	78	34	72		365	369	375	484	568	587	649	714	-
776	 <p><b>Wall unit</b> 2 parallel hinged doors 77.6 cm 2 adjustable shelves</p>	H	80	78	34	702	R/L	258	264	285	399	469	489	536	590	-
		H	90	78	34	702	R/L	258	264	285	399	469	489	536	590	-
		H	100	78	34	702	R/L	285	290	297	425	494	516	562	618	-
776	 <p><b>Wall unit angled by 37.2°</b> 25 cm wide 1 door 30 cm wide, 77.6 cm high 2 adjustable shelves For adjacent fitting left or right</p>	HS	25	78	34	70	R/L	263	268	285	381	386	391	411	452	-
776	 <p><b>Wall unit with folding door</b> 1 sliding-folding door, 2-part, 77.6 cm 2 adjustable shelves</p>	HF	60	78	34	75	R/L	275	292	319	447	493	513	559	615	-
		 <b>Important!</b> Hinge right means drill hole for handle on left-hand side of right door.														
386	 <p><b>Wall unit</b> 2 flap doors 38.6 cm one above the other 1 fixed shelf</p>	H	60	78	34	64		276	290	332	418	451	480	527	580	-
		H	80	78	34	64		434	445	495	605	707	743	814	895	-
		H	90	78	34	64		434	445	495	605	707	743	814	895	-

## Wall units 78 cm high







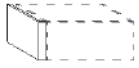

Carcase depth 34 cm

		Order no.		Hinge side:	Carcase depth	Price groups								
		W	H			D	1	2	3	4	5	6	7	8
386 386 	<b>Wall unit</b> 1 folding-lifting door with 2 fronts 38.6 cm 2 adjustable shelves	<b>HFL 45 78 34 68</b>				411	418	472	569	661	700	749	824	-
		<b>HFL 50 78 34 68</b>				413	418	472	569	691	710	769	846	-
		<b>HFL 60 78 34 68</b>				421	432	484	594	697	732	802	882	-
		<b>HFL 80 78 34 68</b>				443	456	505	615	718	752	825	908	-
		<b>HFL 90 78 34 68</b>				443	456	505	615	718	752	825	908	-
		<b>HFL 100 78 34 68</b>				460	469	522	628	732	769	841	925	-
														
<b>Special finish</b> Width reduction for wall units with folding-lifting doors, widths from 61 - 99 cm Only available for models HFL...		<b>SA50</b>	<b>BHFL</b>			126								
 <b>Handle G 029</b> - optional - For on-site installation on the interior side of the lower front of folding-lifting-door wall units. Only possible with model-specific fronts (except FRAME and BERGEN, no glass fronts)		<b>G029</b>				17,30								
776 	<b>Wall unit with spices</b> 1 door 77.6 cm 6 containers 1 spice rack with 12 spice jars 1 adjustable shelf	<b>H 30 78 34 76</b>	R/L		258	264	280	376	381	403	441	485	-	
		<b>H 40 78 34 76</b>	R/L		280	292	310	393	416	438	482	530	-	
		<b>H 45 78 34 76</b>	R/L		280	292	310	402	425	445	489	538	-	
		<b>H 50 78 34 76</b>	R/L		294	302	322	414	441	465	509	560	-	
		<b>H 60 78 34 76</b>	R/L		312	328	346	453	487	513	562	618	-	
														
776 	<b>Wall unit</b> 1 door 77.6 cm 6 containers 1 spice rack WITHOUT spice jars 1 adjustable shelf	<b>H 30 78 34 77</b>	R/L		218	228	244	341	349	365	402	442	-	
		<b>H 40 78 34 77</b>	R/L		245	255	271	360	378	402	440	484	-	
		<b>H 45 78 34 77</b>	R/L		245	255	271	366	389	410	447	492	-	
		<b>H 50 78 34 77</b>	R/L		257	264	287	377	408	425	472	519	-	
		<b>H 60 78 34 77</b>	R/L		275	292	310	418	449	477	523	575	-	
														
776 	<b>Wall unit spacefitter frame</b> 1 door 77.6 cm Carcase depth 10 cm	<b>HPR 30 78 10 70</b>	R/L		146	149	165	264	271	287	317	349	-	
		<b>HPR 40 78 10 70</b>	R/L		163	169	188	284	307	322	357	393	-	
		<b>HPR 45 78 10 70</b>	R/L		163	169	188	292	317	330	365	402	-	
		<b>HPR 50 78 10 70</b>	R/L		173	182	198	304	330	351	381	419	-	
		<b>HPR 60 78 10 70</b>	R/L		191	204	224	347	376	398	437	481	-	

## Front filler 78 cm high

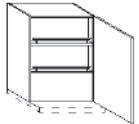
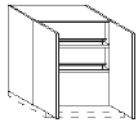
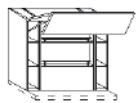
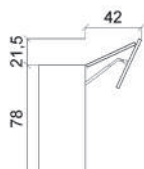
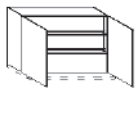
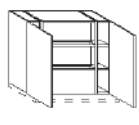
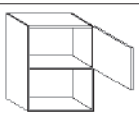
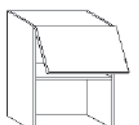
776 	<b>Wall unit front filler</b> 3.5 - 10 cm 10.1 - 20 cm	<b>HP 10 78</b>			53	53	54	86	86	86	94	103	-
		<b>HP 20 78</b>			60	60	68	117	117	117	123	135	-
<b>Wall unit intermediate filler</b> 3.5 - 20 cm		<b>HPZ 20 78</b>			60	60	68	117	117	117	123	135	-
													
776 	<b>Wall unit corner filler</b> 26 x 26 cm, with top and bottom shelf can be used instead of a 60 x 60 cm corner wall unit. Corner dimensions: from 6 x 6 cm (planning dimensions 40 x 40 cm) up to 26 x 26 cm (planning dimensions 60 x 60 cm) available	<b>HPW 26 78</b>			263	278	329	403	419	440	484	532	-
													

# Front filler 78 cm high

		Price groups													
		Order no.	W H D		Hinge side:	Carcase depth	1	2	3	4	5	6	7	8	9
776	 <p><b>Wall unit corner solution</b> Blind-fitted doors This model is intended for corner solution 105 x 105 cm</p>	<b>HEP 26 78 34 85</b>					120	124	141	178	178	178	193	212	-
		 <b>Not available for:</b> <b>ALU TEC RP</b>													
	 <p><b>Middle shelf support for wall units 78 cm high</b> From width 80 cm Aluminium-coloured, with 3 shelf supports</p>	<b>MB S78</b>					27,80								
776	 <p><b>Wall unit end panel</b> on one side Front material 4.8 cm wide, 77.6 cm high, depth 36.1 cm</p>	<b>HAE 78 34</b>					317	325	364	407	449	449	482	530	-
		 <b>Not available for:</b> <b>MIAMI, VIVA</b>													
		 <b>Planning advice:</b> Cannot be planned alongside cornices, light pelmets, sliding door fitting SlideLineM or extractor units													
	 <p><b>Wall unit end panel</b> on one side Front material 4.8 cm wide, 77.6 cm high, depth 36.1 cm</p>	<b>HAEG 78 34</b>					-	-	-	-	-	-	778	856	-
		 <b>Planning advice:</b> Cannot be planned alongside cornices, light pelmets, sliding door fitting SlideLineM or extractor units													

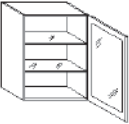
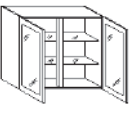
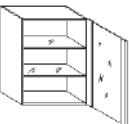

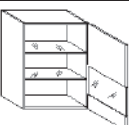


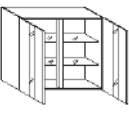

## Extractor hood wall units 78 cm high

Carcase depth 34 cm  
Please indicate appliance type and manufacturer when ordering.

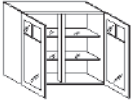

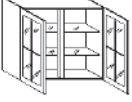

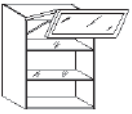
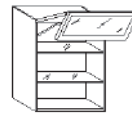
776	 <p><b>Wall unit for cooker hoods</b> For integrated cooker hoods 1 door 77.6 cm 2 adjustable shelves with chrome-plated rail (number of adjustable shelves depends on appliance)</p>	<b>HDI 45 78 34</b>	R/L	273	279	303	420	453	479	525	578	-
		<b>HDI 60 78 34</b>	R/L	273	282	306	422	458	482	528	581	-
776	 <p><b>Wall unit for cooker hoods</b> For integrated cooker hoods 2 doors 77.6 cm 2 adjustable shelves with chrome-plated rail (number of adjustable shelves depends on appliance)</p>	<b>HDI 60 78 34 1</b>		317	325	342	456	502	528	580	638	-
386	 <p><b>Wall unit for cooker hoods</b> For integrated cooker hoods 60 cm, with telescopic hood 90 cm wide 1 folding-lifting door with 2 fronts 38.6 cm 2 adjustable shelves with chrome-plated rail (number of adjustable shelves depends on appliance) 2 adjustable shelves each left and right</p>	<b>HFLDI 90 78 34 X</b>		776	788	840	939	1043	1077	1149	1264	-
												
776	 <p><b>Wall unit for cooker hoods</b> For integrated cooker hoods 2 doors 77.6 cm 2 adjustable shelves with chrome-plated rail (number of adjustable shelves depends on appliance)</p>	<b>HDI 90 78 34</b>		323	331	351	463	508	534	585	644	-
776	 <p><b>Wall unit for cooker hoods</b> <b>For integrated cooker hoods</b> 60 cm, with telescopic hood 90 cm wide 2 doors 77.6 cm 2 adjustable shelves with chrome-plated rail (number of adjustable shelves depends on appliance)</p>	<b>HDI 90 78 34 X</b>		581	588	606	713	763	787	840	924	-
		<b>HDI 100 78 34 X</b>		647	654	657	758	807	826	881	969	-
		<b>HDI 120 78 34 X</b>		687	694	697	796	847	864	921	1013	-
	 <p><b>Wall unit</b> for microwave 1 door or 1 flap door 1 panel (depending on factory possibilities) 1 structural shelf 1 appliance aperture (height depending on appliance type)</p>	<b>HM 50 78 34 70</b>	R/L	196	207	226	329	359	373	411	452	-
		<b>HM 60 78 34 70</b>	R/L	217	228	250	369	403	423	467	514	-
386	 <p><b>Wall unit</b> <b>for microwave</b> 1 flap door 38.6 cm 1 structural shelf 1 appliance aperture (height depending on appliance type)</p>	<b>HM 50 78 34 85</b>		250	254	277	374	421	440	482	530	-
		<b>HM 60 78 34 85</b>		264	276	299	416	448	476	522	574	-

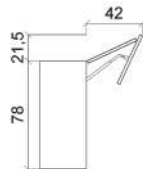
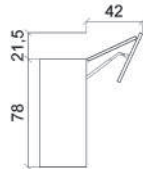
# Wall units, 78 cm high with glass fronts model-specific

Please indicate the desired glass type when ordering. 90 = clear glass 92 = matt glass 93 = black glass

	Order no.	W	H	D	Hinge side:	Carcass depth	Price groups								
							1	2	3	4	5	6	7	8	9
 <p><b>Wall unit with glass door</b> -model-specific- 1 Framed glass door 77,6 cm 2 adjustable glass shelves</p>	HG	45	78	34	RA	R/L	-	-	271	441	441	467	509	560	-
						R/L	-	-	282	447	447	476	519	571	-
						R/L	-	-	295	478	478	500	552	607	-
	<p><b>Available for:</b> ARTE-B, ARTE-S, ATLANTA-B, ATLANTA-S, BERGEN, CASA-B, CASTELLO, CHALET-B, CHALET-S, CHICAGO, FRAME, LUGANO, LUX-B, MIAMI, NEW OPAL-M, NOBEL-B, NOBEL-S, OPAL-H, ORLANDO-B, ORLANDO-S, PALAZZO, PALERMO-B, PALERMO-S, ROMA-B, ROMA-S, SIGNUM-B, SOFIE-B, SOFIE-S, VINO, VIVA, YORK-B, YORK-S</p>														
 <p><b>Wall unit with glass door</b> -model-specific- 2 Framed glass doors 77,6 cm 2 adjustable glass shelves</p>	HG	90	78	34	RA		-	-	403	601	601	617	671	738	-
							-	-	414	601	601	617	671	738	-
	<p><b>Available for:</b> ARTE-B, ARTE-S, ATLANTA-B, ATLANTA-S, BERGEN, CASA-B, CASTELLO, CHALET-B, CHALET-S, CHICAGO, FRAME, LUGANO, LUX-B, MIAMI, NEW OPAL-M, NOBEL-B, NOBEL-S, OPAL-H, ORLANDO-B, ORLANDO-S, PALAZZO, PALERMO-B, PALERMO-S, ROMA-B, ROMA-S, SIGNUM-B, SOFIE-B, SOFIE-S, VINO, VIVA, YORK-B, YORK-S</p>														
 <p><b>Wall unit with glass door</b> -model-specific- 1 semi-frameless glass door 77.6 cm 2 adjustable glass shelves</p>	HG	45	78	34	LS	R/L	264	264	271	441	441	467	509	560	-
						R/L	271	271	282	447	447	476	519	571	-
						R/L	282	282	295	478	478	500	552	607	-
	<p><b>Available for:</b> BAVARIA, EDITION, FENIX INOX, FLORENZ, GARDA, GENT, HPL PRO, MALMÖ, MODENA, MONTANA, MUNICH, NEVADA, OSLO 15, PADUA, PRIMEWOOD TOP, PUR, RESOPAL, RESOPAL PRO, RESOPAL PRO EDGE, RIVA, RUSTY OAK, SHERWOOD, SMART, SMART MIRROR, SMART-M, TESSIN 15, TIM, TIM 15, TOP, TREND, VILLAGE 15-B, VILLAGE 15-S</p>														
 <p><b>Wall unit with glass door</b> -model-specific- 2 semi-frameless glass doors 77.6 cm 2 adjustable glass shelves</p>	HG	90	78	34	LS		396	396	403	601	601	617	671	738	-
							408	408	414	601	601	617	671	738	-
	<p><b>Available for:</b> BAVARIA, EDITION, FENIX INOX, FLORENZ, GARDA, GENT, HPL PRO, MALMÖ, MODENA, MONTANA, MUNICH, NEVADA, OSLO 15, PADUA, PRIMEWOOD TOP, PUR, RESOPAL, RESOPAL PRO, RESOPAL PRO EDGE, RIVA, RUSTY OAK, SHERWOOD, SMART, SMART MIRROR, SMART-M, TESSIN 15, TIM, TIM 15, TOP, TREND, VILLAGE 15-B, VILLAGE 15-S</p>														
 <p><b>Wall unit with glass door</b> -model-specific- 1 segment glass door 77.6 cm 2 adjustable glass shelves</p>	HG	45	78	34	SE	R/L	298	298	303	474	474	496	542	596	-
						R/L	303	303	315	481	481	504	550	605	-
						R/L	315	315	325	506	506	533	582	640	-
	<p><b>Available for:</b> EDITION, FENIX INOX, GARDA, HPL PRO, PRIMEWOOD TOP, PUR, RESOPAL, RESOPAL PRO, RESOPAL PRO EDGE, RIVA, SHERWOOD, SMART, SMART MIRROR, SMART-M, TOP, TREND</p>														
 <p><b>Wall unit with glass door</b> -model-specific- 2 segment glass doors 77.6 cm 2 adjustable glass shelves</p>	HG	90	78	34	SE		426	426	435	630	630	649	702	772	-
							438	438	444	630	630	649	702	772	-
	<p><b>Available for:</b> EDITION, FENIX INOX, GARDA, HPL PRO, PRIMEWOOD TOP, PUR, RESOPAL, RESOPAL PRO, RESOPAL PRO EDGE, RIVA, SHERWOOD, SMART, SMART MIRROR, SMART-M, TOP, TREND</p>														
 <p><b>Wall unit with glass door</b> -model-specific- 1 semi-frameless glass door 77.6 cm Glass width 5 cm 2 adjustable glass shelves</p>	HG	45	78	34	LB	R/L	298	298	303	474	474	496	542	596	-
						R/L	303	303	315	481	481	504	550	605	-
						R/L	315	315	325	506	506	533	582	640	-
	<p><b>Available for:</b> BAVARIA, EDITION, FENIX INOX, FLORENZ, GARDA, HPL PRO, MALMÖ, MODENA, MONTANA, MUNICH, NEVADA, PADUA, PRIMEWOOD TOP, PUR, RESOPAL, RESOPAL PRO, RESOPAL PRO EDGE, RIVA, RUSTY OAK, SHERWOOD, SMART, SMART MIRROR, SMART-M, TOP, TREND</p>														
 <p><b>Wall unit with glass door</b> -model-specific- 2 semi-frameless glass doors 77.6 cm Glass width 5 cm 2 adjustable glass shelves</p>	HG	90	78	34	LB		426	426	435	630	630	649	702	772	-
							438	438	444	630	630	649	702	772	-
	<p><b>Available for:</b> BAVARIA, EDITION, FENIX INOX, FLORENZ, GARDA, HPL PRO, MALMÖ, MODENA, MONTANA, MUNICH, NEVADA, PADUA, PRIMEWOOD TOP, PUR, RESOPAL, RESOPAL PRO, RESOPAL PRO EDGE, RIVA, RUSTY OAK, SHERWOOD, SMART, SMART MIRROR, SMART-M, TOP, TREND</p>														
 <p><b>Wall unit with glass door</b> -model-specific- 1 glass door 77.6 cm with mullions 2 adjustable glass shelves</p>	HGS	45	78	34		R/L	-	-	586	749	749	-	-	-	-
						R/L	-	-	599	759	759	-	-	-	-
						R/L	-	-	611	785	785	-	-	-	-
	<p><b>Available for:</b> ARTE-B, ARTE-S, CHALET-B, CHALET-S, LUX-B, NOBEL-B, NOBEL-S, PALERMO-B, PALERMO-S, ROMA-B, ROMA-S, SOFIE-B, SOFIE-S, YORK-B, YORK-S</p> <p><b>Number of mullions/fields:</b> width 45 cm: 1 centre bar / 2 fields 13 cm x 13 cm each (W x H) width 50 cm: 1 centre bar / 2 fields 15.5 cm x 13 cm each (W x H) width 60 cm: 2 centre bars / 3 fields 13 cm x 13 cm each (W x H)</p>														

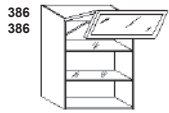
# Wall units, 78 cm high with glass fronts model-specific

		Price groups										
		Hinge side:	Carcase depth	1	2	3	4	5	6	7	8	9
Please indicate the desired glass type when ordering. 90 = clear glass 92 = matt glass 93 = black glass		Order no. W H D										
776	 <p><b>Wall unit with glass door</b> -model-specific- 2 glass doors 77.6 cm with mullions 2 adjustable glass shelves</p>	HGS 90 78 34		-	-	1035	1218	1218	-	-	-	-
		HGS 100 78 34		-	-	1045	1218	1218	-	-	-	-
		<p><b>Available for:</b> ARTE-B, ARTE-S, CHALET-B, CHALET-S, LUX-B, NOBEL-B, NOBEL-S, PALERMO-B, PALERMO-S, ROMA-B, ROMA-S, SOFIE-B, SOFIE-S, YORK-B, YORK-S</p> <p><b>Number of mullions/fields:</b> Width 45 cm: 1 centre bar / 2 fields 13 cm x 13 cm each (W x H) Width 50 cm: 1 centre bar / 2 fields 15,5 cm x 13 cm each (W x H)</p>										
776	 <p><b>Wall unit with glass door</b> -model-specific- 1 glass door 77.6 cm with crossbar 2 adjustable glass shelves</p>	HGKS 45 78 34	R/L	-	-	586	749	749	-	-	-	-
		HGKS 50 78 34	R/L	-	-	599	759	759	-	-	-	-
		HGKS 60 78 34	R/L	-	-	611	785	785	-	-	-	-
		<p><b>Available for:</b> ARTE-B, ARTE-S, CHALET-B, CHALET-S, LUX-B, NOBEL-B, NOBEL-S, PALERMO-B, PALERMO-S, ROMA-B, ROMA-S, SOFIE-B, SOFIE-S, YORK-B, YORK-S</p>										
776	 <p><b>Wall unit with glass door</b> -model-specific- 2 glass doors 77.6 cm with crossbar 2 adjustable glass shelves</p>	HGKS 90 78 34		-	-	1035	1218	1218	-	-	-	-
		HGKS100 78 34		-	-	1045	1218	1218	-	-	-	-
		<p><b>Available for:</b> ARTE-B, ARTE-S, CHALET-B, CHALET-S, LUX-B, NOBEL-B, NOBEL-S, PALERMO-B, PALERMO-S, ROMA-B, ROMA-S, SOFIE-B, SOFIE-S, YORK-B, YORK-S</p>										
776	 <p><b>Wall unit with glass door</b> 1 glass door 77.6 cm Glass type: clear glass 2 adjustable glass shelves Visible side left or right in front finish with clear glass instead of normal carcass side Carcass inside and outside in micro textured lacquer or velvet lacquer Hinge left = door hinge and visible side in front finish left Hinge right = door hinge and visible side in front finish right</p>	HGL 45 78 34	R/L	-	-	1105	1105	1105	-	-	-	-
		HGL 50 78 34	R/L	-	-	1138	1138	1138	-	-	-	-
		HGL 60 78 34	R/L	-	-	1212	1212	1212	-	-	-	-
		<p><b>Available for:</b> ARTE-B, ARTE-S, CHALET-B, CHALET-S, LUX-B, NOBEL-B, NOBEL-S, PALERMO-B, PALERMO-S, ROMA-B, ROMA-S, SOFIE-B, SOFIE-S, YORK-B, YORK-S</p> <p><b>Door hinged left = door hinge and visible side in front finish left</b> <b>Door hinged right = door hinge and visible side in front finish right</b></p>										
386	 <p><b>Wall unit</b> -model-specific- 1 folding-lifting door with front 38.6 cm at top and one glass front 38.6 cm at bottom 2 adjustable glass shelves</p>	HFLMG60 78 34		492	505	559	665	769	806	871	958	-
		HFLMG90 78 34		522	534	585	691	793	828	901	991	-
		<p><b>Available for:</b> ARTE-B, ARTE-S, ATLANTA-B, ATLANTA-S, BERGEN, CASA-B, CASTELLO, CHALET-B, CHALET-S, CHICAGO, FRAME, LUGANO, LUX-B, MIAMI, NEW OPAL-M, NOBEL-B, NOBEL-S, OPAL-H, ORLANDO-B, ORLANDO-S, PALERMO-B, PALERMO-S, ROMA-B, ROMA-S, SIGNUM-B, SOFIE-B, SOFIE-S, VINO, VIVA, YORK-B, YORK-S</p>										
386	 <p><b>Wall unit</b> -model-specific- 1 folding-lifting door with 38.6 cm glass front at top and 38.6 cm glass front at bottom 2 adjustable glass shelves</p>	HFLG 60 78 34		562	579	633	738	842	880	943	1037	-
		HFLG 90 78 34		598	613	667	767	869	904	975	1073	-
		<p><b>Available for:</b> ARTE-B, ARTE-S, ATLANTA-B, ATLANTA-S, BERGEN, CASA-B, CASTELLO, CHALET-B, CHALET-S, CHICAGO, FRAME, LUGANO, LUX-B, MIAMI, NEW OPAL-M, NOBEL-B, NOBEL-S, OPAL-H, ORLANDO-B, ORLANDO-S, PALERMO-B, PALERMO-S, ROMA-B, ROMA-S, SIGNUM-B, SOFIE-B, SOFIE-S, VINO, VIVA, YORK-B, YORK-S</p>										



# Wall units, 78 cm high with glass fronts model-specific

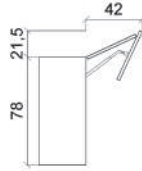
Please indicate the desired glass type when ordering. 90 = clear glass 92 = matt glass 93 = black glass



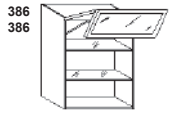
**Wall unit**  
-neutral- basis G2  
1 folding-lifting door with front 38.6 cm at top and glass front 38.6 cm at bottom  
2 adjustable glass shelves

Order no.  
W H D

<b>HFLMD45 78 34</b>
<b>HFLMD50 78 34</b>
<b>HFLMD60 78 34</b>
<b>HFLMD80 78 34</b>
<b>HFLMD90 78 34</b>
<b>HFLMD100 78 34</b>



Hinge side:	Carcase depth	Price groups								
		1	2	3	4	5	6	7	8	9
		655	660	672	746	832	848	865	952	-
		655	660	672	746	832	848	865	952	-
		663	668	687	771	850	870	919	1011	-
		685	691	737	773	856	871	919	1011	-
		685	691	737	773	856	871	919	1011	-
		711	718	764	799	885	898	930	1023	-



**Wall unit**  
-AktivGlas-  
1 folding-lifting door with front 38.6 cm at top and glass front 38.6 cm at bottom -AktivGlas-  
2 adjustable glass shelves

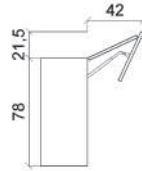
AKTIV  
GLAS

<b>HFLMDA60 78 34</b>
<b>HFLMDA80 78 34</b>
<b>HFLMDA90 78 34</b>
<b>HFLMDA100 78 34</b>



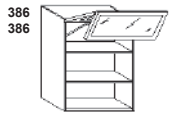
**Available glass versions:**  
991 = AktivGlas front - glass matt / frame stainless steel-coloured  
992 = AktivGlas front - black glass translucent, night black frame

**Planning advice:**  
Without drill hole for handle, knobs/handles not possible with grip ledge in bottom shelf



## Wall units 78 cm high with glass fronts neutral

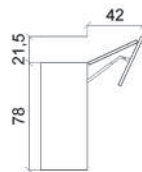
Carcase depth 34 cm



**Wall unit**  
-neutral-  
1 folding-lifting door with 38.6 cm glass front at top and 38.6 cm glass front at bottom  
2 adjustable glass shelves

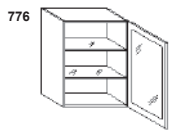
Order no.  
W H D

<b>HFLD 45 78 34</b>
<b>HFLD 50 78 34</b>
<b>HFLD 60 78 34</b>
<b>HFLD 80 78 34</b>
<b>HFLD 90 78 34</b>
<b>HFLD 100 78 34</b>



## Glass groups

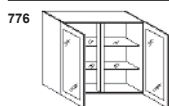
Hinge side:	Carcase depth	Glass groups				
		G1	G2	G2S	G5S	G6
		-	842	-	-	-
		-	849	-	-	-
		-	889	-	-	-
		-	934	-	-	-
		-	953	-	-	-
		-	1024	-	-	-



**Wall unit with glass door**  
-neutral-  
1 glass door 77.6 cm  
2 adjustable glass shelves

<b>HGD 45 78 34 70</b>	R/L
<b>HGD 50 78 34 70</b>	R/L
<b>HGD 60 78 34 70</b>	R/L

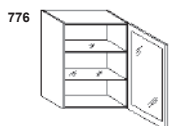
		-	480	480	547	864
		-	496	496	576	880
		-	543	543	634	927



**Wall unit with glass door**  
-neutral-  
2 glass doors 77.6 cm  
2 adjustable glass shelves

<b>HGD 90 78 34 70</b>
<b>HGD 100 78 34 70</b>

		-	827	827	934	1211
		-	864	864	991	1248



**Wall unit with glass door**  
-AktivGlas-  
1 AktivGlas door 77.6 cm  
2 adjustable glass shelves

AKTIV  
GLAS

<b>HGDA 45 78 34 70</b>
<b>HGDA 50 78 34 70</b>
<b>HGDA 60 78 34 70</b>



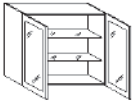



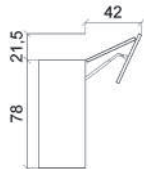
**Planning advice:**  
Without drill hole for handle, knobs/handles not possible with grip ledge in bottom shelf

		R/L	361	-	-	-	-
		R/L	368	-	-	-	-
		R/L	399	-	-	-	-



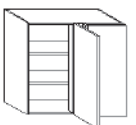
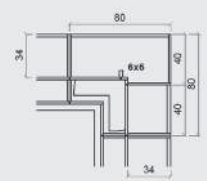
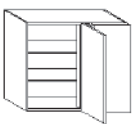
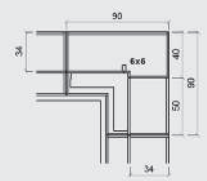
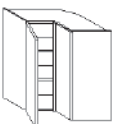


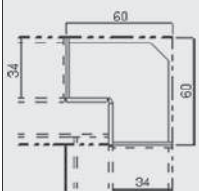
# Wall units 78 cm high with glass fronts neutral

Carcase depth 34 cm

		Order no.		Hinge side:		Price groups														
		W H D		Carcase depth		G1	G2	G2S	G5S	G6										
776	 <p><b>Wall unit with glass door</b> -AktivGlas- 2 AktivGlas doors 77.6 cm Without centre panel 2 adjustable glass shelves</p>	AKTIV GLAS	HGDA 90 78 34 70			578	-	-	-	-										
			HGDA100 78 34 70			596	-	-	-	-										
 <b>Planning advice:</b> Without drill hole for handle, knobs/handles not possible with grip ledge in bottom shelf																				
386 386	 <p><b>Wall unit</b> -AktivGlas- 1 folding-lifting door with AktivGlas front 38.6 cm at top and AktivGlas front 38.6 cm at bottom 2 adjustable glass shelves</p>	AKTIV GLAS	HFLDA60 78 34			629	-	-	-	-										
			HFLDA80 78 34			648	-	-	-	-										
			HFLDA90 78 34			648	-	-	-	-										
			HFLDA10078 34			678	-	-	-	-										
 <b>Planning advice:</b> Without drill hole for handle, knobs/handles not possible with grip ledge in bottom shelf																				
																				
<b>G 1</b>			<b>G 2</b>			<b>G 2S</b>														
<b>G1 AKTIVglass frame</b> 991 Matt glass 992 Translucent black glass			<b>G2 Design front</b> 925 Frame White Agate/Matt glass 935 Premium W. Frame/Matt Glass 940 Macaron Col. Frame/Matt Glass 95 Light grey frame/matt glass 96 Silver Col. Frame/Matt Glass 960 Snow White Frame/Matt Glass 97 Black frame/black glass			<b>G2S aluminium, framed glass door</b> 988 aluminium black, Linea glass 994 Aluminium frame/clear glass 995 aluminium frame/black glass														
<b>G 5</b>			<b>G 5S</b>			<b>G 6</b>														
			G5S aluminium, door with mullion 996 Alum.frame/clear gl./cross bar			<b>G6 NEW SALON</b> 986 aluminium black, black glass 987 aluminium black, clear glass 989 aluminium matt, bronze-coloured black glass 990 aluminium matt, bronze-coloured clear glass														




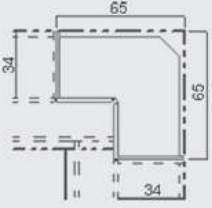



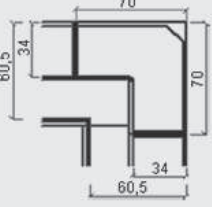
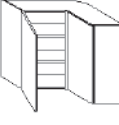

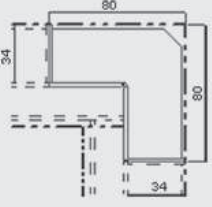
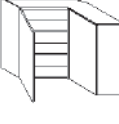

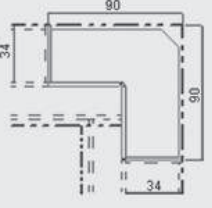
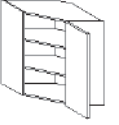



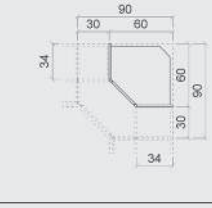
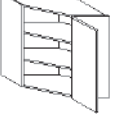



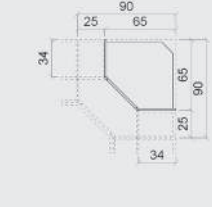
# Corner wall units 78 cm high

Carcase depth 34 cm

		Order no.		Hinge side:		Price groups								
		W H D		Carcase depth		1	2	3	4	5	6	7	8	9
776	 <p><b>Corner wall unit</b> 80 cm wide, 1 door 77.6 cm (40 cm wide) 2 adjustable shelves Blind section left or right</p>	HE	80 78 34 701	R/L		308	324	359	410	427	447	493	542	-
														
776	 <p><b>Corner wall unit</b> 90 cm wide, 1 door 77.6 cm (50 cm wide) 2 adjustable shelves Blind section left or right</p>	HE	90 78 34 701	R/L		308	324	359	410	427	447	493	542	-
														
776	 <p><b>Corner wall unit</b> side length 60 x 60 cm 2 doors 77.6 cm (20 cm wide) Right door with corner angle 5.6 x 5.6 cm 2 adjustable shelves</p>		HE 60 78 34 75			306	321	371	442	462	482	532	585	-
			 <b>width 20 cm: FRAME, VILLAGE 15-S, VILLAGE 15-B, CHALET-S, CHALET-B, OSLO 15, TESSIN 15, BERGEN, LUGANO, CASTELLO, VIVA, TIM 15 are supplied with smooth fronts.</b>											
														

# Corner wall units 78 cm high

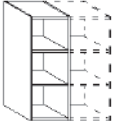
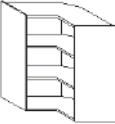
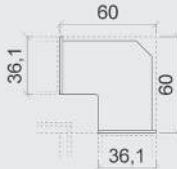

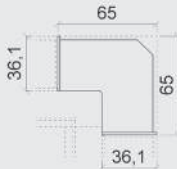
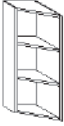





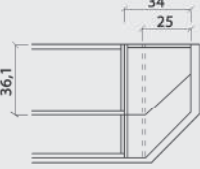

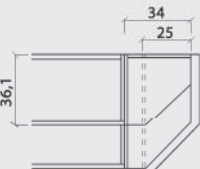
Carcase depth 34 cm

		Order no.		Hinge side:	Carcase depth	Price groups								
		W	H			D	1	2	3	4	5	6	7	8
776	 <p><b>Corner wall unit</b> side length 65 x 65 cm 2 doors 77.6 cm (25 cm wide) Right door with corner angle 5.6 x 5.6 cm 2 adjustable shelves</p>		<b>HE 65 78 34 75</b>			374	390	441	513	528	555	610	671	-
			<b>HE 65 78 34 75 PO</b>			374	390	441	513	528	555	610	671	-
						 width 25 cm: <b>FRAME</b> are supplied with smooth fronts.								
														
776	 <p><b>Corner wall unit</b> side length 70 x 70 cm 2 doors 77.6 cm (30 cm wide) Right door with corner angle 5.6 x 5.6 cm 2 adjustable shelves</p>		<b>HE 70 78 34 75</b>			654	676	767	898	921	970	1068	1175	-
					 For configurations with base unit carcass depth 60.5 cm and worktop depth 65 cm.									
														
776	 <p><b>Corner wall unit</b> side length 80 x 80 cm 2 doors 77.6 cm (40 cm wide) Right door with corner angle 5.6 x 5.6 cm 2 adjustable shelves</p>		<b>HE 80 78 34 75</b>			666	688	779	908	932	981	1080	1188	-
														
776	 <p><b>Corner wall unit</b> side length 90 x 90 cm 2 doors 77.6 cm (50 cm wide) Right door with corner angle 5.6 x 5.6 cm 2 adjustable shelves</p>		<b>HE 90 78 34 75</b>			691	716	812	944	971	1021	1121	1233	-
														
776	 <p><b>Diagonal corner wall unit</b> side length 60 x 60 cm 1 door 77.6 cm (30 cm wide) 2 adjustable shelves</p>		<b>HDE 60 78 70</b>	R/L		367	371	392	481	505	532	582	640	-
					 <b>Not available for:</b>  <b>ALU TEC RP</b>									
														
776	 <p><b>Diagonal corner wall unit</b> side length 65 x 65 cm 1 door 77.6 cm (40 cm wide) 2 adjustable shelves</p>		<b>HDE 65 78 70</b>	R/L		367	371	392	481	505	532	582	640	-
					 <b>Not available for:</b>  <b>ALU TEC RP</b>									
														

# Wall shelf units 78 cm high


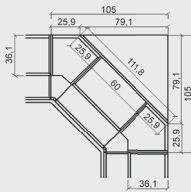


Carcase depth 36.1 cm

Order no.  
W H D

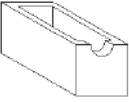
Hinge side:	Carcase depth	Decor groups									
		M10	M20	M30	M40	M50	M60	M70	M80	M90	
 <p><b>Wall shelf unit</b> 2 adjustable shelves wide in cm: 13-30 wide in cm: 30,1-40 wide in cm: 40,1-45 wide in cm: 45,1-50 wide in cm: 50,1-60 wide in cm: 60,1-80 wide in cm: 80,1-90</p>		<b>HR 30 78 36</b>	183	-	-	-	639	-	639	639	-
		<b>HR 40 78 36</b>	183	-	-	-	639	-	639	639	-
		<b>HR 45 78 36</b>	183	-	-	-	639	-	639	639	-
		<b>HR 50 78 36</b>	183	-	-	-	639	-	639	639	-
		<b>HR 60 78 36</b>	183	-	-	-	639	-	639	639	-
		<b>HR 80 78 36</b>	224	-	-	-	721	-	961	961	-
		<b>HR 90 78 36</b>	224	-	-	-	721	-	961	961	-
	 <p><b>Corner wall shelf unit</b> side length 60 x 60 cm 2 adjustable shelves</p> <p>Planning dimensions 60 x 60 cm</p> 		<b>HRE 60 78 36</b>	288	-	-	-	1211	-	1211	1211
 <p><b>Corner wall shelf unit</b> side length 65 x 65 cm 2 adjustable shelves</p> <p>Planning dimensions 65 x 65 cm</p> 		<b>HRE 65 78 36</b>	359	-	-	-	1333	-	1333	1333	-
 <p><b>Wall shelf unit angled by 37.2°</b> 25 cm wide 2 adjustable shelves For adjacent fitting left or right</p>	R/L	<b>HRS 25 78 36</b>	215	-	-	-	580	-	580	580	-
 <p><b>Wall shelf unit</b> Shelves angled at front 2 fixed shelves</p> <p> <b>Important!</b> Please state right and left carcase depth (minimum depth 10 cm)</p>	R/L	<b>HRS 00 78 36</b>	255	-	-	-	828	-	828	828	-
 <p><b>Plate rack drainer set</b> consisting of: Rack, drip tray, frame</p>		<b>Z 149-60</b>	91								
		<b>Z 149-90</b>	114								
 <p><b>Wall shelf end unit</b> 25 x 36.1 cm 2 fixed shelves For adjacent fitting left or right</p> <p> <b>Important!</b> Only available in 25 cm width.</p> 	R/L	<b>HRA 25 78 36</b>	196	-	-	-	465	-	465	465	-
 <p><b>Wall shelf end unit</b> 34 x 36.1 cm 2 fixed shelves For adjacent fitting left or right</p> 	R/L	<b>HRA 34 78 36</b>	196	-	-	-	535	-	535	535	-

# Wall shelf units 78 cm high

Carcase depth 36.1 cm

		Decor groups								
		M10	M20	M30	M40	M50	M60	M70	M80	M90
	<b>Wall unit corner solution</b> Spacefitter shelf unit 2 fixed shelves	<b>HRE 26 78 36</b> 141 - - - 621 - - -								
		This model is intended for corner solution 105 x 105 cm 								
	<b>Flour, sugar and rice scoops in carcass decors</b> including 3 lead-crystal scoops Capacity 750 ml, crystal clear for installing below wall units or for featuring in wall units Size (W x H x D) 36.8 x 13. x 17. cm	<b>SR 37 13 17</b> 546 - - - - - - -								
		Only in conjunction with carcass decor group K								
	<b>Wall shelf unit for containers</b> 15 cm wide, Prepared for 5 containers	<b>HRSK 15 78 36</b> 198 - - - 540 - 540 540 -								
<b>M 10</b>	<b>M 20</b>	<b>M 30</b>	<b>M 40</b>	<b>M 50</b>						
K M10 laminate				B M50 Velvet lacquer S M50 microstructure lacquer						
<b>M 60</b>	<b>M 70</b>	<b>M 80</b>	<b>M 90</b>							
	F M70 veneer / oak / walnut Z M70 Veneer / Bavaria	H M80 high gloss-Lacquer MP M80 laqué mat Premium								

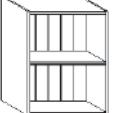


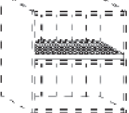
## Container

	<b>Container, 11 cm high</b> for 15 cm wide shelf unit	<b>SKH 15 13</b> - - - - 159 - 159 - -								
<b>M 10</b>	<b>M 20</b>	<b>M 30</b>	<b>M 40</b>	<b>M 50</b>						
				B M50 Velvet Lacquer S M50 Microstructure Lacquer						
<b>M 60</b>	<b>M 70</b>	<b>M 80</b>	<b>M 90</b>							
	F M70 veneer / oak / walnut									

## Wall shelf units 78 cm high Country-house elements

Carcase depth 36.1 cm

fixed shelves 25 mm with profile at top and bottom

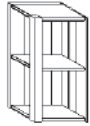
	<b>Wall shelf unit</b> Flush with front, depth 36.1 cm Grooved back panel 1 adjustable shelf	<b>HRL 30 78 36</b> - - - - 558 - - -								
		<b>HRL 45 78 36</b> - - - - 678 - - -								
		<b>HRL 60 78 36</b> - - - - 823 - - -								
		<b>HRL 90 78 36</b> - - - - 1085 - - -								
 	<b>Wall shelf unit with containers</b> Flush with front, depth 36.1 cm Grooved back panel 1 fixed shelf, 1 adjustable shelf 30 cm width: 1 container 45 cm width: 2 containers 60 cm width: 2 containers 90 cm width: 3 containers	<b>HRSL 30 78 36</b> - - - - 814 - - -								
		<b>HRSL 45 78 36</b> - - - - 1061 - - -								
		<b>HRSL 60 78 36</b> - - - - 1185 - - -								
		<b>HRSL 90 78 36</b> - - - - 1621 - - -								
	<b>Plate rack insert</b> Suitable for shelf widths 45 cm 60 cm 90 cm	<b>TEL 45</b> - - - - 162 - - -								
		<b>TEL 60</b> - - - - 195 - - -								
		<b>TEL 90</b> - - - - 236 - - -								

# Wall shelf units 78 cm high Country-house elements

Carcase depth 36.1 cm  
fixed shelves 25 mm with profile at top and bottom

Order no.  
W H D

Hinge side: Carcase depth	Decor groups									
	M10	M20	M30	M40	M50	M60	M70	M80	M90	
R/L	-	-	-	-	840	-	-	-	-	

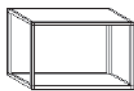


**Wall shelf end unit**  
**With 1 pilaster at front with frieze**  
Width 40 cm, carcase depth 36.1 cm  
Flush with front  
Grooved back panel and side panel  
1 fixed shelf



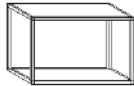
M 10	M 20	M 30	M 40	M 50
				B M50 Velvet Lacquer S M50 Microstructure lacquer
M 60	M 70	M 80	M 90	

## Smart Cube wall shelf unit 39 cm high / 78 cm high



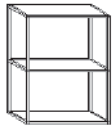
**Wall shelf unit Smart Cube**  
for hanging  
Finish: metal stainless steel-coloured  
Dimensions: height 39 cm, depth 25 cm  
Incl. 2 shelves 1.6 cm thick

Carcase height 39 cm



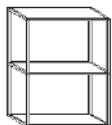
**Wall shelf unit Smart Cube**  
for hanging  
Finish: aluminium black  
Dimensions: height 39 cm, depth 25 cm  
Incl. 2 shelves 1.6 cm thick

Carcase height 39 cm



**Wall shelf unit Smart Cube**  
for hanging  
Finish: metal stainless steel-coloured  
consisting of:  
4 Smart Cube connecting elements  
6 lengthways profile  
2 side elements  
3 shelves 1.6 cm thick  
height 78 cm  
depth 25 cm

Carcase height 78 cm

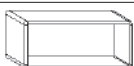


**Wall shelf unit Smart Cube**  
for hanging  
Finish: aluminium black  
consisting of:  
4 Smart Cube connecting elements  
6 lengthways profile  
2 side elements  
3 shelves 1.6 cm thick  
height 78 cm  
depth 25 cm

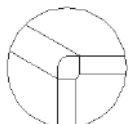
Carcase height 78 cm

<b>HRDM 60 39 25</b>	391	410	-	-	498	-	553	-	-
<b>HRDM 90 39 25</b>	439	466	-	-	599	-	705	-	-
<b>HRDM120 39 25</b>	474	511	-	-	692	-	805	-	-
<b>HRDS 60 39 25</b>	391	410	-	-	498	-	553	-	-
<b>HRDS 90 39 25</b>	439	466	-	-	599	-	705	-	-
<b>HRDS120 39 25</b>	474	511	-	-	692	-	805	-	-
<b>HRDM 60 78 25</b>	626	654	-	-	784	-	864	-	-
<b>HRDM 90 78 25</b>	697	736	-	-	931	-	1054	-	-
<b>HRDM120 78 25</b>	745	799	-	-	1059	-	1220	-	-
<p><b>Planning advice:</b> please do not plan the 78 cm height Smart Cube wall shelf units at the same height as the 39 cm height Smart Cube wall shelf units.</p>									
<b>HRDS 60 78 25</b>	626	654	-	-	784	-	864	-	-
<b>HRDS 90 78 25</b>	697	736	-	-	931	-	1054	-	-
<b>HRDS120 78 25</b>	745	799	-	-	1059	-	1220	-	-
<p><b>Planning advice:</b> please do not plan the 78 cm height Smart Cube wall shelf units at the same height as the 39 cm height Smart Cube wall shelf units.</p>									

M 10	M 20	M 30	M 40	M 50
K M10 laminate	D M20 Laminate decor			B M50 Velvet Lacquer S M50 Microstructure Lacquer
M 60	M 70	M 80	M 90	
	F M70 veneer / oak / walnut			




**Aluminium designer shelf**  
Finish aluminium black anodised  
Concealed wall mounting  
Can be mounted horizontally or vertically  
Widths 60 cm and 90 cm  
Dimensions: (W x H x D)  
60/90 cm x 26 cm x 18 cm




<b>HADR 60 26 18</b>	218
<b>HADR 90 26 18</b>	243
<p><b>Planning advice:</b> As an option, a back panel, e.g. made of 16 mm panel material (WS16) can be installed Materials from 4 to 22 mm can be used for the back panel Example for back panel panelling: Special sized panel shelf 1.6 mm as back panel panelling Dimensions for width 60 cm: (W x D x H) 58.1 cm x 24.1 cm x 1.6 cm Dimensions for width 90 cm: (W x D x H) 88.1 cm x 24.1 cm x 1.6 cm</p>	

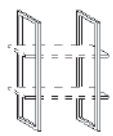

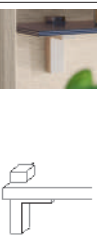
## Panels 16 mm

		Decor groups													
		Order no.			Hinge side:	Carcase depth	M10	M20	M30	M40	M50	M60	M70	M80	M90
		W H D													
<b>Panel shelf 16 mm</b> edge on all sides		pro m <sup>2</sup> , B x D													
		<b>WBS 16</b>					84	143	324	432	432	432	612	793	173
		 <b>Important!</b> This material is not suitable for table tops! Maximum dimensions see section 2													
M 10	M 20	M 30	M 40	M 50											
K16 M10 Laminate	D16 M20 Laminate decor	I16 M30 RESOPAL PRO super matt IH16 M30 HPL PRO PW16 M30 PRIMEWOOD/Basic Veneer	A16 M40 DIRECTLACK matt L16 M40 DIRECTLACK high-gloss,	B16 M50 Velvet lacquer P16 M50 Soft lacquer R16H M50 Velvet lacquer wood texture R16W M50 Velvet lacquer spackle S16 M50 micro structured lacquer											
M 60	M 70	M 80	M 90												
Q16H M60 SMARTGLAS high-gloss Q16M M60 SMARTGLAS satin-finish	F16 M70 veneer / walnut / oak 16 mm V16 M70 Velvet lacquer textured Z16 M70 Veneer / Bavaria 16 mm	C116 M80 FENIX stainless-steel look H16 M80 High gloss-Lacquer MP16 M80 Matt-Lacquer Premium O16 M80 veneer	A116 M90 Worktop decor												

## Panels 25 mm

		Decor groups													
		Order no.			Hinge side:	Carcase depth	M10	M20	M30	M40	M50	M60	M70	M80	M90
		W H D													
<b>Panel shelf 25 mm</b> edge on all sides		pro m <sup>2</sup> , B x D													
		<b>WBS 25</b>					138	200	-	-	448	-	700	875	-
		 <b>Important!</b> This material is not suitable for table tops! Maximum dimensions see section 2													
M 10	M 20	M 30	M 40	M 50											
K25 M10 Laminate 25 mm	D25 M20 Accessory decor D149W Brown concrete effect D187W Concrete effect opal D188W Concrete effect pearl grey D212W graphite concrete effect			B25 M50 Velvet lacquer S25 M50 micro structured lacquer											
M 60	M 70	M 80	M 90												
	F25 M70 veneer / oak Z25 M70 veneer / Bavaria	H25 M80 High gloss-Lacquer MP25 M80 Matt-Lacquer Premium O25 M80 Veneered													


## Smartframe wall shelf unit 78 cm high

 <p><b>Wall shelf unit Smartframe for hanging</b>                      Finish: metal, anthracite Mounted for 2 shelves,                      incl. shelf supports                      Dimensions: height 78 cm, depth 25 cm                      1 set = 2 wall shelf units</p> <p>Finish: stainless steel-coloured                      Finish: black</p>	 <b>Recommendation: plan one Smartframe wall shelf unit every 60 cm</b> <b>Please order shelves separately</b> <b>Shelf depth: 21.2 cm</b> For shelves, see section: Panels, stiles															
	<b>HRSFM78 25</b>															234
	<b>HRSF 78 25</b>															234
 <p><b>Shelf support</b>                      Finish: stainless steel-coloured                      for fixing shelves up to 25 cm depth                      (thickness 8-50 mm) to walls                      Max. distance between supports 45 cm                      The shelf bracket adds 6 mm.                      Subtract this value from the final dimension of                      the shelf.                      Maximum load: 16 kg</p>																
	<b>Z 130</b>															39

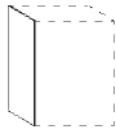

## Background fillers 78 cm high

		Decor groups													
		Order no.			Hinge side:	Carcase depth	M10	M20	M30	M40	M50	M60	M70	M80	M90
		W H D													
<b>Wall unit background filler</b> Width: 20 cm For fitting flush with carcass		<b>HPSL 00 78</b>					26,90	28,50	51	68	68	68	68	68	-

## Background fillers 78 cm high

		Order no. W H D		Hinge side:	Carcase depth	Decor groups									
						M10	M20	M30	M40	M50	M60	M70	M80	M90	
	<b>Wall unit side</b> without drill holes for panels e.g. at sides of cooker hoods etc. please state exact height	<b>HS</b>				39	129	176	233	234	244	244	244	-	
<b>M 10</b>	<b>M 20</b>	<b>M 30</b>		<b>M 40</b>		<b>M 50</b>									
K M10 laminate	D M20 Laminate decor	I M30 RESOPAL PRO super matt IH M30 HPL PRO PW M30 PRIMEWOOD/Basic Veneeer		A M40 DIRECTLACK matt L M40 DIRECTLACK high-gloss A M40 DIRECTLACK matt		B M50 Velvet lacquer P M50 Soft lacquer S M50 microstructure lacquer									
<b>M 60</b>	<b>M 70</b>	<b>M 80</b>		<b>M 90</b>											
QH M60 SMARTGLAS high-gloss QM M60 SMARTGLAS satin-finish	F M70 veneer / oak / walnut Z M70 Veneer / Bavaria	C1 M80 FENIX stainless-steel look H M80 high gloss-Lacquer MP M80 laqué mat Premium													

## Visible sides / increased side depth 78 cm high

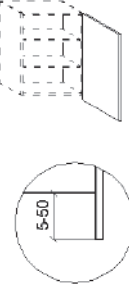


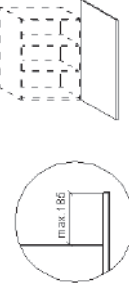


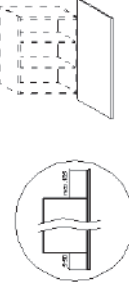




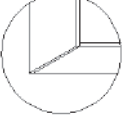



	<b>Wall unit visible side</b>	<b>HSV 78</b>		R/L		0	0	52	52	69	69	74	101	-
<i>Important!</i> Installation instead of a normal unit side.														
	<b>Wall unit increased side depth</b> Up to 57.5 cm side depth	<b>HSVT 78</b>		R/L		57	65	112	112	148	148	163	223	-
<i>Important!</i> Installation instead of a normal unit side.														
<b>M 10</b>	<b>M 20</b>	<b>M 30</b>		<b>M 40</b>		<b>M 50</b>								
K M10 laminate	D M20 Laminate decor	I M30 RESOPAL PRO super matt IH M30 HPL PRO PW M30 PRIMEWOOD/Basic Veneeer		A M40 DIRECTLACK matt L M40 DIRECTLACK high-gloss		B M50 Velvet lacquer P M50 Soft lacquer RH M50 Velvet lacquer wood texture RW M50 Velvet lacquer spackle effect S M50 microstructure lacquer								
<b>M 60</b>	<b>M 70</b>	<b>M 80</b>		<b>M 90</b>										
QH M60 SMARTGLAS high-gloss QM M60 SMARTGLAS satin-finish	F M70 veneer / oak / walnut V M70 Velvet lacquer textured Z M70 Veneer / Bavaria	C1 M80 FENIX stainless-steel look H M80 high gloss-Lacquer MP M80 laqué mat Premium O M80 Veneered												

## Additional equipment

<b>Surcharge for wall cabinets with glass fronts inside and exterior in the same design</b> available in decor groups: S/B/H/MP/F/Z	<b>IDF-H</b>				-	-	-	-	495	-	495	495	-	
<b>M 10</b>	<b>M 20</b>	<b>M 30</b>		<b>M 40</b>		<b>M 50</b>								
K M10 laminate						B M50 Velvet lacquer S M50 microstructure lacquer								
<b>M 60</b>	<b>M 70</b>	<b>M 80</b>		<b>M 90</b>										
	F M70 veneer / oak / walnut Z M70 Veneer / Bavaria	H M80 high gloss-Lacquer MP M80 laqué mat Premium												



# Front extension 78 cm high

	Order no. W H D	Hinge side:	Carcase depth	Price groups									
				1	2	3	4	5	6	7	8	9	
 <p><b>Extra charge front extension</b> For wall unit doors Can be extended downwards by 5 cm Please note that twice the quantity is needed for 2-door units</p>				<b>FVHU 20</b>	46	49	51	72	98	100	109	120	-
				<b>FVHU 25</b>	46	49	51	72	98	100	109	120	-
				<b>FVHU 30</b>	46	49	51	72	98	100	109	120	-
				<b>FVHU 40</b>	49	50	52	76	105	112	121	133	-
				<b>FVHU 45</b>	50	51	53	78	109	114	123	135	-
				<b>FVHU 50</b>	51	52	54	83	113	120	131	144	-
				<b>FVHU 60</b>	53	54	59	87	118	133	144	158	-
				 <b>Not available for:</b> MIAMI, VIVA   Only available for wall cabinets with hinged doors. The front will be delivered as a separate package. Wall units with glass doors, corner units, diagonal units or angled units are <b>not</b> available with front extension.									
 <p><b>Extra charge front extension</b> For wall unit doors can be extended upwards by maximum 18.5 cm Please note that twice the quantity is needed for 2-door units</p>				<b>FVHO 20</b>	46	49	51	72	98	100	109	120	-
				<b>FVHO 25</b>	46	49	51	72	98	100	109	120	-
				<b>FVHO 30</b>	46	49	51	72	98	100	109	120	-
				<b>FVHO 40</b>	49	50	52	76	105	112	121	133	-
				<b>FVHO 45</b>	50	51	53	78	109	114	123	135	-
				<b>FVHO 50</b>	51	52	54	83	113	120	131	144	-
				<b>FVHO 60</b>	53	54	59	87	118	133	144	158	-
				 <b>Not available for:</b> MIAMI, VIVA   Only available for wall cabinets with hinged doors. The front will be delivered as a separate package. Wall units with glass doors, corner units, diagonal units or angled units are <b>not</b> available with front extension.									
 <p><b>Extra charge front extension</b> For wall unit doors Can be extended upwards and downwards can be extended upwards by maximum 18.5 cm Can be extended downwards by 5 cm Please note that twice the quantity is needed for 2-door units</p>				<b>FVHUO20</b>	89	96	101	144	195	200	216	238	-
				<b>FVHUO25</b>	89	96	101	144	195	200	216	238	-
				<b>FVHUO30</b>	89	96	101	144	195	200	216	238	-
				<b>FVHUO40</b>	96	99	103	155	209	224	241	265	-
				<b>FVHUO45</b>	99	101	107	159	216	228	246	271	-
				<b>FVHUO50</b>	101	103	109	165	226	239	262	288	-
				<b>FVHUO60</b>	107	109	118	175	234	264	290	319	-
				 <b>Not available for:</b> MIAMI, VIVA   Only available for wall cabinets with hinged doors. The front will be delivered as a separate package. Wall units with glass doors, corner units, diagonal units or angled units are <b>not</b> available with front extension.									
 <p><b>Wall unit front filler with front extension</b> Can be extended upwards and downwards can be extended upwards by maximum 18.5 cm Can be extended downwards by 5 cm</p>				<b>HPFV 10 78</b>	98	101	105	158	184	187	204	224	-
				<b>HPFV 20 78</b>	105	109	119	189	214	216	231	254	-
 <b>Not available for:</b> MIAMI, VIVA													
 <p><b>Wall unit with full-width bottom structural shelf</b> Requirement: - Wall units up to 100 cm width - Wall units up to 78 cm height - Standard carcass decors decor group K</p>				<b>MP-HDUK</b>	75								
				 <b>Not available for:</b> Corner wall units with side lengths 60 x 60 cm, 65 x 65 cm, 80 x 80 cm, 90 x 90 cm Wall units with roller shutter Bottom shelves with LED lighting system „UP&DOWN“									
 <p><b>Extra charge for grip ledge on bottom shelf of wall units</b></p>				<b>MP-KBKL</b>	31								
				 cannot be featured in corner wall units, diagonal units, bevelled units									

# 5.4

## Wall units, 91 cm high

Wall units 91 cm high	XL 5.4.2
Front filler 91 cm high	XL 5.4.3
Extractor hood wall units 91 cm high	XL 5.4.3-XL 5.4.4
Wall units 91 cm high with glass fronts model-specific	XL 5.4.4-XL 5.4.5
Wall units 91 cm high with glass fronts neutral	XL 5.4.6
Corner wall units 91 cm high	XL 5.4.6-XL 5.4.7
Wall shelf units 91 cm high	XL 5.4.8-XL 5.4.9
Container	XL 5.4.9
Wall shelf units 91 cm high Country-house elements	XL 5.4.10
Background filler 91 cm high	XL 5.4.11
Visible sides / increased side depth 91 cm high	XL 5.4.11
Additional equipment	XL 5.4.11
Front extension 91 cm high	XL 5.4.12

### Legend:



Available with grip ledge N...



Not available with grip ledge N...



This symbol indicates which models are available



This symbol indicates which models are not available



Planning advice

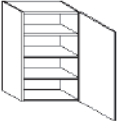













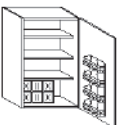

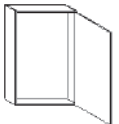
Height  
91 cm

# The most important wall unit models 91 cm high


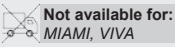

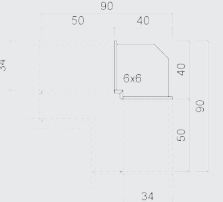

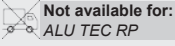
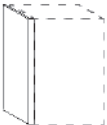
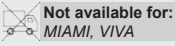

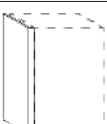

Page XL 5.4.2	Page XL 5.4.2	Page XL 5.4.2	Page XL 5.4.2	Page XL 5.4.2	Page XL 5.4.2	Page XL 5.4.2	Page XL 5.4.2	Page XL 5.4.3
H..913470 Unit widths: 20/25/30/40/ 45/50/60	H..913470 Unit widths: 80/90/100	H..9134702 Unit widths: 80/90	HS..913470 Unit widths: 25	HF..913475 Unit widths: 60	H..913476 Unit widths: 30/40/45/50/60	H..913477 Unit widths: 30/40/45/50/60	HPR..911070 Unit widths: 30/40/45/50/60	HP..91 Unit widths: 3,5-20
Page XL 5.4.3	Page XL 5.4.3	Page XL 5.4.3	Page XL 5.4.3	Page XL 5.4.3	Page XL 5.4.3	Page XL 5.4.3	Page XL 5.4.4	Page XL 5.4.4
HPW..91 Unit widths: 60X60	HEP..913485 Unit widths: 105x105	HAE..34 Unit widths: 4,8	HDI..9134 Unit widths: 45/60	HDI..91341 Unit widths: 60	HDI..9134 Unit widths: 90	HDI..9134X Unit widths: 90/100	HM..913470 Unit widths: 50/60	HG..9134RA Unit widths: 45/50/60
Page XL 5.4.4	Page XL 5.4.4	Page XL 5.4.4	Page XL 5.4.4	Page XL 5.4.4	Page XL 5.4.4	Page XL 5.4.4	Page XL 5.4.5	Page XL 5.4.5
HG..9134RA Unit widths: 90/100	HG..9134LS Unit widths: 45/50/60	HG..9134LS Unit widths: 90/100	HG..9134SE Unit widths: 45/50/60	HG..9134SE Unit widths: 90/100	HG..9134LB Unit widths: 45/50/60	HG..9134LB Unit widths: 90/100	HGS..9134 Unit widths: 45/50/60	HGS..9134 Unit widths: 90/100
Page XL 5.4.5	Page XL 5.4.5	Page XL 5.4.5	Page XL 5.4.6	Page XL 5.4.6	Page XL 5.4.6	Page XL 5.4.6	Page XL 5.4.6	Page XL 5.4.6
HGKS..9134 Unit widths: 45/50/60	HGKS..9134 Unit widths: 90/100	HGL..9134 Unit widths: 45/50/60	HGDA..913470 Unit widths: 45/50/60	HGDA..913470 Unit widths: 90/100	HGD..913470 Unit widths: 45/50/60	HGD..913470 Unit widths: 90/100	HE..9134701 Unit widths: 80	HE..9134701 Unit widths: 90
Page XL 5.4.6	Page XL 5.4.7	Page XL 5.4.7	Page XL 5.4.7	Page XL 5.4.7	Page XL 5.4.7	Page XL 5.4.7	Page XL 5.4.8	Page XL 5.4.8
HE..913475 Unit widths: 60x60	HE..913475 Unit widths: 65x65	HE..913475 Unit widths: 70x70	HE..913475 Unit widths: 80x80	HE..913475 Unit widths: 90x90	HDE..9170 Unit widths: 60x60	HDE..9170 Unit widths: 65x65	HR..9136 Unit widths: 30/40/45/50/60	HRE..9136 Unit widths: 60x60
Page XL 5.4.8	Page XL 5.4.8	Page XL 5.4.8	Page XL 5.4.8	Page XL 5.4.8	Page XL 5.4.9	Page XL 5.4.9	Page XL 5.4.10	Page XL 5.4.10
HRE..9136 Unit widths: 65x65	HRE..9136 Unit widths: 25	HRE..9136 Unit widths: 15-60	HRA259136 Unit widths: 25	HRA349136 Unit widths: 34	HRE269136 Unit widths: 105x105	SR..1317 Unit widths: 37	HRL..9136 Unit widths: 30/45/60/90	HRSL..9136 Unit widths: 30/45/60/90

# Wall units 91 cm high

Carcase depth 34 cm



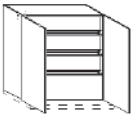
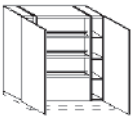
		Order no.	W	H	D	Hinge side:	Carcase depth	Price groups									
								1	2	3	4	5	6	7	8	9	
 <p><b>Wall unit</b> 1 door 90.6 cm 3 adjustable shelves</p>		<b>H</b>	<b>20</b>	<b>91</b>	<b>34</b>	<b>70</b>	R/L	155	161	173	282	287	301	331	364	-	
		<b>H</b>	<b>25</b>	<b>91</b>	<b>34</b>	<b>70</b>	R/L	155	161	173	282	287	301	331	364	-	
		<b>H</b>	<b>30</b>	<b>91</b>	<b>34</b>	<b>70</b>	R/L	155	161	173	282	287	301	331	364	-	
		<b>H</b>	<b>40</b>	<b>91</b>	<b>34</b>	<b>70</b>	R/L	172	179	198	300	323	338	373	410	-	
		<b>H</b>	<b>45</b>	<b>91</b>	<b>34</b>	<b>70</b>	R/L	172	179	198	306	332	351	379	417	-	
		<b>H</b>	<b>50</b>	<b>91</b>	<b>34</b>	<b>70</b>	R/L	183	192	213	322	351	368	406	447	-	
		<b>H</b>	<b>60</b>	<b>91</b>	<b>34</b>	<b>70</b>	R/L	200	215	234	366	400	416	462	508	-	
		<b>H</b>	<b>70</b>	<b>91</b>	<b>34</b>	<b>70</b>	R/L	259	273	299	430	496	536	568	625	-	
 width 20 cm: <i>FRAME, VILLAGE 15-S, VILLAGE 15-B, CHALET-S, CHALET-B, OSLO 15, TESSIN 15, BERGEN, LUGANO, CASTELLO, VIVA, TIM 15</i> are supplied with smooth fronts. width 25 cm: <i>FRAME</i> are supplied with smooth fronts.																	
 <p><b>Wall unit</b> 1 door 90.6 cm 3 adjustable glass shelves With „push to open“ fitting</p>		<b>SE</b>	<b>H</b>	<b>60</b>	<b>91</b>	<b>34</b>	<b>70</b>	R/L	-	-	-	-	-	-	-	-	1091
	 Available for: <i>STRIP ELEMENTS</i>																
	 Available finishes: <i>775 Ash black lacquered</i>																
 <p><b>Cable compartment for on-site installation in wall units</b> below top shelf for accommodating electrical items such as converters, cables etc. Consisting of left-hand and right-hand sides and bottom shelf Panel removable With ventilation grille</p>		<b>KF</b>	<b>45</b>						138								
		<b>KF</b>	<b>50</b>						138								
		<b>KF</b>	<b>60</b>						138								
	 Finish: decor group K Suitable for unit models with side-hung doors																
 <p><b>Wall unit</b> 2 doors 90.6 cm 3 adjustable shelves</p>		<b>H</b>	<b>80</b>	<b>91</b>	<b>34</b>	<b>70</b>			259	273	299	430	496	536	568	625	-
		<b>H</b>	<b>90</b>	<b>91</b>	<b>34</b>	<b>70</b>			259	273	299	430	496	536	568	625	-
		<b>H</b>	<b>100</b>	<b>91</b>	<b>34</b>	<b>70</b>			287	302	324	455	527	562	597	657	-
 <p><b>Wall unit</b> 2 parallel hinged doors 90.6 cm 3 adjustable shelves</p>		<b>H</b>	<b>80</b>	<b>91</b>	<b>34</b>	<b>702</b>	R/L	282	300	321	449	523	559	594	653	-	
		<b>H</b>	<b>90</b>	<b>91</b>	<b>34</b>	<b>702</b>	R/L	282	300	321	449	523	559	594	653	-	
 <p><b>Wall unit angled, 37.2°</b> 25 cm wide 1 door 30 cm wide, 90.6 cm high 3 adjustable shelves For adjacent fitting left or right</p>		<b>HS</b>	<b>25</b>	<b>91</b>	<b>34</b>	<b>70</b>	R/L	277	282	299	403	408	410	432	475	-	
 <p><b>Wall unit with folding door</b> 1 sliding-folding door, 2-part, 90.6 cm 3 adjustable shelves</p>		<b>HF</b>	<b>60</b>	<b>91</b>	<b>34</b>	<b>75</b>	R/L	290	306	331	474	519	537	586	645	-	
	 Important! Hinge right means drill hole for handle on left-hand side of right door.																
 <p><b>Wall unit with spices</b> 1 door 90.6 cm 6 containers 1 spice rack with 12 spice jars 2 adjustable shelves</p>		<b>H</b>	<b>30</b>	<b>91</b>	<b>34</b>	<b>76</b>	R/L	268	278	297	399	403	423	467	514	-	
		<b>H</b>	<b>40</b>	<b>91</b>	<b>34</b>	<b>76</b>	R/L	297	306	325	412	438	462	506	557	-	
		<b>H</b>	<b>45</b>	<b>91</b>	<b>34</b>	<b>76</b>	R/L	297	306	325	419	445	472	517	569	-	
		<b>H</b>	<b>50</b>	<b>91</b>	<b>34</b>	<b>76</b>	R/L	307	319	339	437	467	485	536	590	-	
		<b>H</b>	<b>60</b>	<b>91</b>	<b>34</b>	<b>76</b>	R/L	328	343	367	479	513	537	595	655	-	
 Not available for: <i>BERGEN, FRAME, LUGANO</i>																	
 <p><b>Wall unit</b> 1 door 90.6 cm 6 containers 1 spice rack WITHOUT spice jars 2 adjustable shelves</p>		<b>H</b>	<b>30</b>	<b>91</b>	<b>34</b>	<b>77</b>	R/L	229	237	257	363	366	378	419	461	-	
		<b>H</b>	<b>40</b>	<b>91</b>	<b>34</b>	<b>77</b>	R/L	258	264	288	374	402	419	465	512	-	
		<b>H</b>	<b>45</b>	<b>91</b>	<b>34</b>	<b>77</b>	R/L	258	264	288	381	409	431	474	521	-	
		<b>H</b>	<b>50</b>	<b>91</b>	<b>34</b>	<b>77</b>	R/L	267	278	300	400	427	445	490	539	-	
		<b>H</b>	<b>60</b>	<b>91</b>	<b>34</b>	<b>77</b>	R/L	290	306	325	439	477	498	550	605	-	
 Not available for: <i>BERGEN, FRAME, LUGANO</i>																	
 <p><b>Wall unit spacefitter frame</b> 1 door 90.6 cm Carcase depth 10 cm</p>		<b>HPR</b>	<b>30</b>	<b>91</b>	<b>10</b>	<b>70</b>	R/L	155	161	173	282	287	301	331	364	-	
		<b>HPR</b>	<b>40</b>	<b>91</b>	<b>10</b>	<b>70</b>	R/L	171	178	196	299	322	337	371	408	-	
		<b>HPR</b>	<b>45</b>	<b>91</b>	<b>10</b>	<b>70</b>	R/L	171	178	196	304	331	349	378	416	-	
		<b>HPR</b>	<b>50</b>	<b>91</b>	<b>10</b>	<b>70</b>	R/L	182	191	211	321	349	367	403	443	-	
		<b>HPR</b>	<b>60</b>	<b>91</b>	<b>10</b>	<b>70</b>	R/L	199	214	233	365	399	414	460	506	-	

# Front filler 91 cm high

				Price groups										
		Order no. W H D		Hinge side:	Carcase depth	1	2	3	4	5	6	7	8	9
906	 <b>Wall unit front filler</b> 3.5 - 10 cm 11 - 20 cm	<b>HP 10 91</b>				57	57	57	105	105	105	108	119	-
		<b>HP 20 91</b>				63	64	71	140	140	140	144	158	-
	<b>Wall unit intermediate filler</b> 3.5 - 20 cm	<b>HPZ 20 91</b>				64	64	71	140	140	140	146	161	-
														
906	 <b>Wall unit corner filler</b> 26 x 26 cm, with top and bottom shelf can be used instead of a 60 x 60 cm corner wall unit. Corner dimensions: from 6 x 6 cm (planning dimensions 40 x 40 cm) up to 26 x 26 cm (planning dimensions 60 x 60 cm) available	<b>HPW 26 91</b>				277	295	345	423	440	465	512	563	-
														
906	 <b>Wall unit corner solution</b> Blind-fitted doors This model is intended for corner solution 105 x 105 cm	<b>HEP 26 91 34 85</b>				125	131	147	186	186	186	207	228	-
														
906	 <b>Wall unit end panel</b> on one side Front material 4.8 cm wide, 90.6 cm high, depth 36.1 cm	<b>HAE 91 34</b>				342	352	390	434	479	479	506	557	-
		  <b>Planning advice:</b> Cannot be planned alongside cornices, light pelmets, sliding door fitting SlideLineM or extractor units												
906	 <b>Wall unit end panel</b> on one side Front material 4.8 cm wide, 90.6 cm high, depth 36.1 cm	<b>HAEG 91 34</b>				-	-	-	-	-	-	812	893	-
		 <b>Planning advice:</b> Cannot be planned alongside cornices, light pelmets, sliding door fitting SlideLineM or extractor units												

## Extractor hood wall units 91 cm high

Carcase depth 34 cm  
Please indicate appliance type and manufacturer when ordering.

906	 <b>Wall unit for cooker hoods</b> For integrated cooker hoods 1 door 90.6 cm 3 adjustable shelves with chrome-plated rail (number of adjustable shelves depends on appliance)	<b>HDI 45 91 34</b>	R/L	285	297	317	442	479	496	549	604	-
		<b>HDI 60 91 34</b>	R/L	285	299	320	444	482	504	557	613	-
906	 <b>Wall unit for cooker hoods</b> For integrated cooker hoods 2 doors 90.6 cm 3 adjustable shelves with chrome-plated rail (number of adjustable shelves depends on appliance)	<b>HDI 60 91 34 1</b>		332	340	363	481	528	557	608	669	-
906	 <b>Wall unit for cooker hoods</b> For integrated cooker hoods 2 doors 90.6 cm 3 adjustable shelves with chrome-plated rail (number of adjustable shelves depends on appliance)	<b>HDI 90 91 34</b>		340	346	368	487	534	562	615	677	-
906	 <b>Wall unit for cooker hoods</b> For integrated cooker hoods 60 cm, with telescopic hood 90 cm wide 2 doors 90.6 cm 3 adjustable shelves with chrome-plated rail (number of adjustable shelves depends on appliance)	<b>HDI 90 91 34 X</b>		598	604	626	738	787	813	866	953	-
		<b>HDI 100 91 34 X</b>		664	669	681	782	832	853	912	1003	-
		width 100 cm 60 cm with telescopic hood 90 cm wide										

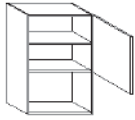
# Extractor hood wall units 91 cm high

Carcase depth 34 cm

Please indicate appliance type and manufacturer when ordering.

Order no.  
W H D

Hinge side:	Carcase depth	Price groups								
		1	2	3	4	5	6	7	8	9
R/L		208	216	235	347	373	393	432	475	-
R/L		228	237	260	386	423	442	487	536	-



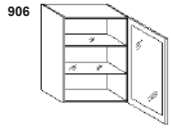
**Wall unit**  
for microwave  
1 door or 1 flap door  
1 panel  
(depending on factory possibilities)  
1 structural shelf  
1 adjustable shelf  
1 appliance aperture  
(height depending on appliance type)

<b>HM 50 91 34 70</b>	R/L									
<b>HM 60 91 34 70</b>	R/L									

## Wall units 91 cm high with glass fronts model-specific

Carcase depth 34 cm

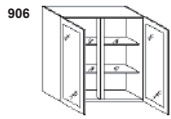
Please indicate the desired glass type when ordering. 90 = clear glass 92 = matt glass 93 = black glass



**Wall unit with glass door**  
-model-specific-  
1 Framed glass door 90,6 cm  
2 adjustable glass shelves

<b>HG 45 91 34 RA</b>	R/L	-	-	288	467	467	487	536	590	-
<b>HG 50 91 34 RA</b>	R/L	-	-	298	474	474	496	546	601	-
<b>HG 60 91 34 RA</b>	R/L	-	-	308	500	500	526	579	637	-

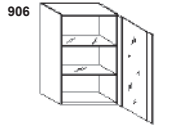
**Available for:**  
ARTE-B, ARTE-S, ATLANTA-B, ATLANTA-S, BERGEN, CASA-B, CASTELLO, CHALET-B, CHALET-S, CHICAGO, FRAME, LUGANO, LUX-B, MIAMI, NEW OPAL-M, NOBEL-B, NOBEL-S, OPAL-H, ORLANDO-B, ORLANDO-S, PALAZZO, PALERMO-B, PALERMO-S, ROMA-B, ROMA-S, SIGNUM-B, SOFIE-B, SOFIE-S, VINO, VIVA, YORK-B, YORK-S



**Wall unit with glass door**  
-model-specific-  
2 Framed glass doors 90,6 cm  
2 adjustable glass shelves

<b>HG 90 91 34 RA</b>		-	-	431	622	622	644	700	770	-
<b>HG 100 91 34 RA</b>		-	-	495	716	716	740	803	883	-

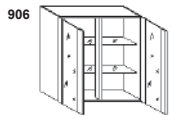
**Available for:**  
ARTE-B, ARTE-S, ATLANTA-B, ATLANTA-S, BERGEN, CASA-B, CASTELLO, CHALET-B, CHALET-S, CHICAGO, FRAME, LUGANO, LUX-B, MIAMI, NEW OPAL-M, NOBEL-B, NOBEL-S, OPAL-H, ORLANDO-B, ORLANDO-S, PALAZZO, PALERMO-B, PALERMO-S, ROMA-B, ROMA-S, SIGNUM-B, SOFIE-B, SOFIE-S, VINO, VIVA, YORK-B, YORK-S



**Wall unit with glass door**  
-model-specific-  
1 semi-frameless glass door 90.6 cm  
2 adjustable glass shelves

<b>HG 45 91 34 LS</b>	R/L	278	278	288	467	467	487	536	590	-
<b>HG 50 91 34 LS</b>	R/L	288	288	298	474	474	496	546	601	-
<b>HG 60 91 34 LS</b>	R/L	298	298	308	500	500	526	579	637	-

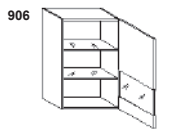
**Available for:**  
BAVARIA, EDITION, FENIX INOX, FLORENZ, GARDA, GENT, HPL PRO, MALMÖ, MODENA, MONTANA, MUNICH, NEVADA, OSLO 15, PADUA, PRIMEWOOD TOP, PUR, RESOPAL, RESOPAL PRO, RESOPAL PRO EDGE, RIVA, RUSTY OAK, SHERWOOD, SMART, SMART MIRROR, SMART-M, TESSIN 15, TIM, TIM 15, TOP, TREND, VILLAGE 15-B, VILLAGE 15-S



**Wall unit with glass door**  
-model-specific-  
2 semi-frameless glass doors 90.6 cm  
2 adjustable glass shelves

<b>HG 90 91 34 LS</b>		419	419	431	622	622	644	700	770	-
<b>HG 100 91 34 LS</b>		483	483	495	716	716	740	803	883	-

**Available for:**  
BAVARIA, EDITION, FENIX INOX, FLORENZ, GARDA, GENT, HPL PRO, MALMÖ, MODENA, MONTANA, MUNICH, NEVADA, OSLO 15, PADUA, PRIMEWOOD TOP, PUR, RESOPAL, RESOPAL PRO, RESOPAL PRO EDGE, RIVA, RUSTY OAK, SHERWOOD, SMART, SMART MIRROR, SMART-M, TESSIN 15, TIM, TIM 15, TOP, TREND, VILLAGE 15-B, VILLAGE 15-S



**Wall unit with glass door**  
-model-specific-  
1 segment glass door 90.6 cm  
2 adjustable glass shelves

<b>HG 45 91 34 SE</b>	R/L	310	310	320	496	496	517	566	623	-
<b>HG 50 91 34 SE</b>	R/L	320	320	328	502	502	530	577	635	-
<b>HG 60 91 34 SE</b>	R/L	328	328	340	533	533	555	615	677	-

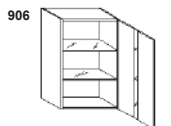
**Available for:**  
EDITION, FENIX INOX, GARDA, HPL PRO, PRIMEWOOD TOP, PUR, RESOPAL, RESOPAL PRO, RESOPAL PRO EDGE, RIVA, SHERWOOD, SMART, SMART MIRROR, SMART-M, TOP, TREND



**Wall unit with glass door**  
-model-specific-  
2 segment glass doors 90.6 cm  
2 adjustable glass shelves

<b>HG 90 91 34 SE</b>		448	448	463	653	653	676	731	804	-
<b>HG 100 91 34 SE</b>		515	515	527	745	745	772	835	919	-

**Available for:**  
EDITION, FENIX INOX, GARDA, HPL PRO, PRIMEWOOD TOP, PUR, RESOPAL, RESOPAL PRO, RESOPAL PRO EDGE, RIVA, SHERWOOD, SMART, SMART MIRROR, SMART-M, TOP, TREND



**Wall unit with glass door**  
-model-specific-  
1 semi-frameless glass door 90.6 cm  
Glass width 5 cm  
2 adjustable glass shelves

<b>HG 45 91 34 LB</b>	R/L	310	310	320	496	496	517	566	623	-
<b>HG 50 91 34 LB</b>	R/L	320	320	328	502	502	530	577	635	-
<b>HG 60 91 34 LB</b>	R/L	328	328	340	533	533	555	615	677	-

**Available for:**  
BAVARIA, EDITION, FENIX INOX, FLORENZ, GARDA, HPL PRO, MALMÖ, MODENA, MONTANA, MUNICH, NEVADA, PADUA, PRIMEWOOD TOP, PUR, RESOPAL, RESOPAL PRO, RESOPAL PRO EDGE, RIVA, RUSTY OAK, SHERWOOD, SMART, SMART MIRROR, SMART-M, TOP, TREND



**Wall unit with glass door**  
-model-specific-  
2 semi-frameless glass doors 90.6 cm  
Glass width 5 cm  
2 adjustable glass shelves




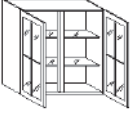


<b>HG 90 91 34 LB</b>		448	448	463	653	653	676	731	804	-
<b>HG 100 91 34 LB</b>		515	515	527	745	745	772	835	919	-

**Available for:**  
BAVARIA, EDITION, FENIX INOX, FLORENZ, GARDA, HPL PRO, MALMÖ, MODENA, MONTANA, MUNICH, NEVADA, PADUA, PRIMEWOOD TOP, PUR, RESOPAL, RESOPAL PRO, RESOPAL PRO EDGE, RIVA, RUSTY OAK, SHERWOOD, SMART, SMART MIRROR, SMART-M, TOP, TREND





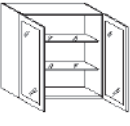



# Wall units 91 cm high with glass fronts model-specific

Carcase depth 34 cm

						Price groups									
		Order no.		Hinge side:	Carcase depth	1	2	3	4	5	6	7	8	9	
		W	H			D									
906	 <p><b>Wall unit with glass door</b> -model-specific- 1 glass door 90.6 cm with mullions 2 adjustable glass shelves</p>	HGS	45	91	34	R/L	-	-	605	776	776	-	-	-	-
		HGS	50	91	34	R/L	-	-	613	782	782	-	-	-	-
		HGS	60	91	34	R/L	-	-	624	810	810	-	-	-	-
						<p><b>Available for:</b> ARTE-B, ARTE-S, CHALET-B, CHALET-S, LUX-B, NOBEL-B, NOBEL-S, PALERMO-B, PALERMO-S, ROMA-B, ROMA-S, SOFIE-B, SOFIE-S, YORK-B, YORK-S</p> <p><b>Number of mullions/fields:</b> width 45 cm: 1 centre bar / 2 fields 13 cm x 13 cm each (W x H) width 50 cm: 1 centre bar / 2 fields 15.5 cm x 13 cm each (W x H) width 60 cm: 2 centre bars / 3 fields 13 cm x 13 cm each (W x H)</p>									
906	 <p><b>Wall unit with glass door</b> -model-specific- 2 glass doors 90.6 cm with mullions 2 adjustable glass shelves</p>	HGS	90	91	34		-	-	1064	1239	1239	-	-	-	-
		HGS	100	91	34		-	-	1129	1333	1333	-	-	-	-
								<p><b>Available for:</b> ARTE-B, ARTE-S, CHALET-B, CHALET-S, LUX-B, NOBEL-B, NOBEL-S, PALERMO-B, PALERMO-S, ROMA-B, ROMA-S, SOFIE-B, SOFIE-S, YORK-B, YORK-S</p> <p><b>Number of mullions/fields:</b> Width 45 cm: 1 centre bar / 2 fields 13 cm x 13 cm each (W x H) Width 50 cm: 1 centre bar / 2 fields 15.5 cm x 13 cm each (W x H)</p>							
906	 <p><b>Wall unit with glass door</b> -model-specific- 1 glass door 90.6 cm with crossbar 2 adjustable glass shelves</p>	HGKS	45	91	34	R/L	-	-	605	776	776	-	-	-	-
		HGKS	50	91	34	R/L	-	-	613	782	782	-	-	-	-
		HGKS	60	91	34	R/L	-	-	624	810	810	-	-	-	-
						<p><b>Available for:</b> ARTE-B, ARTE-S, CHALET-B, CHALET-S, LUX-B, NOBEL-B, NOBEL-S, PALERMO-B, PALERMO-S, ROMA-B, ROMA-S, SOFIE-B, SOFIE-S, YORK-B, YORK-S</p>									
906	 <p><b>Wall unit with glass door</b> -model-specific- 2 glass doors 90.6 cm with crossbar 2 adjustable glass shelves</p>	HGKS	90	91	34		-	-	1064	1239	1239	-	-	-	-
		HGKS	100	91	34		-	-	1129	1333	1333	-	-	-	-
								<p><b>Available for:</b> ARTE-B, ARTE-S, CHALET-B, CHALET-S, LUX-B, NOBEL-B, NOBEL-S, PALERMO-B, PALERMO-S, ROMA-B, ROMA-S, SOFIE-B, SOFIE-S, YORK-B, YORK-S</p>							
906	 <p><b>Wall unit with glass door</b> 1 glass door 90.6 cm Glass type: clear glass 2 adjustable glass shelves Visible side left or right in front finish With clear glass instead of normal carcass side Carcass inside and outside in micro textured lacquer or velvet lacquer</p> 	HGL	45	91	34	R/L	-	-	1220	1220	1220	-	-	-	-
		HGL	50	91	34	R/L	-	-	1259	1259	1259	-	-	-	-
		HGL	60	91	34	R/L	-	-	1339	1339	1339	-	-	-	-
						<p><b>Available for:</b> ARTE-B, ARTE-S, CHALET-B, CHALET-S, LUX-B, NOBEL-B, NOBEL-S, PALERMO-B, PALERMO-S, ROMA-B, ROMA-S, SOFIE-B, SOFIE-S, YORK-B, YORK-S</p> <p><b>Door hinged left = door hinge and visible side in front finish left</b> <b>Door hinged right = door hinge and visible side in front finish right</b></p>									


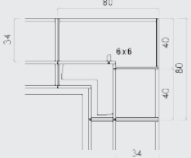
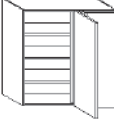
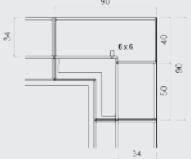


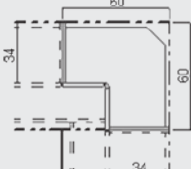

# Wall units 91 cm high with glass fronts neutral

Carcase depth 34 cm

		Order no.			Hinge side:	Carcase depth	Glass groups							
		W	H	D			G1	G2	G2S	G5S	G6			
906	 <p><b>Wall unit with glass door</b> -neutral- 1 AktivGlas door 90.6 cm 2 adjustable glass shelves</p>	AKTIV GLAS	HGDA 45 91 34 70	R/L	373	-	-	-	-					
			HGDA 50 91 34 70	R/L	383	-	-	-	-					
			HGDA 60 91 34 70	R/L	410	-	-	-	-					
			 <b>Planning advice:</b> Without drill hole for handle, knobs/handles not possible with grip ledge in bottom shelf											
906	 <p><b>Wall unit with glass door</b> -neutral- 2 AktivGlas doors 90.6 cm Without centre panel 2 adjustable glass shelves</p>	AKTIV GLAS	HGDA 90 91 34 70		608	-	-	-	-					
			HGDA100 91 34 70		700	-	-	-	-					
			 <b>Planning advice:</b> Without drill hole for handle, knobs/handles not possible with grip ledge in bottom shelf											
906	 <p><b>Wall unit with glass door</b> -neutral- 1 glass door 90.6 cm 2 adjustable glass shelves</p>		HGD 45 91 34 70	R/L	-	502	502	583	886					
			HGD 50 91 34 70	R/L	-	526	526	613	910					
			HGD 60 91 34 70	R/L	-	579	579	678	963					
906	 <p><b>Wall unit with glass door</b> -neutral- 2 glass doors 90.6 cm 2 adjustable glass shelves</p>		HGD 90 91 34 70		-	873	873	987	1257					
			HGD 100 91 34 70		-	990	990	1136	1374					
<b>G 1</b>			<b>G 2</b>			<b>G 2S</b>								
<b>G1 AKTIVglass frame</b> 991 Matt glass 992 Translucent black glass			<b>G2 Design front</b> 925 Frame White Agate/Matt glass 935 Premium W. Frame/Matt Glass 940 Macaron Col. Frame/Matt Glass 95 Light grey frame/matt glass 96 Silver Col. Frame/Matt Glass 960 Snow White Frame/Matt Glass 97 Black frame/black glass			<b>G2S aluminium, framed glass door</b> 988 aluminium black, Linea glass 994 Aluminium frame/clear glass 995 aluminium frame/black glass								
<b>G 5</b>			<b>G 5S</b>			<b>G 6</b>								
			<b>G5S aluminium, door with mullion</b> 996 Alum.frame/clear gl./cross bar			<b>G6 NEW SALON</b> 986 aluminium black, black glass 987 aluminium black, clear glass 989 aluminium matt, bronze-coloured black glass 990 aluminium matt, bronze-coloured clear glass								




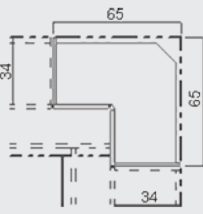
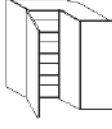


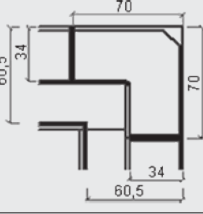
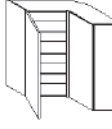

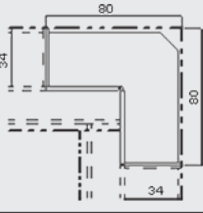


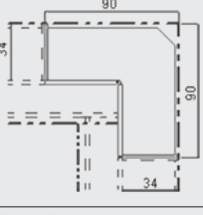
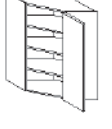


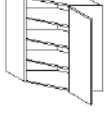

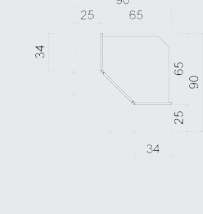
# Corner wall units 91 cm high

Carcase depth 34 cm

		Order no.			Hinge side:	Carcase depth	Price groups								
		W	H	D			1	2	3	4	5	6	7	8	9
906	 <p><b>Corner wall unit</b> 80 cm wide, 1 door 90.6 cm (40 cm wide) 3 adjustable shelves Blind section left or right</p>	HE	80 91 34 701	R/L	324	340	374	431	446	474	519	571	-		
															
906	 <p><b>Corner wall unit</b> 90 cm wide, 1 door 90.6 cm (50 cm wide) 3 adjustable shelves Blind section left or right</p>	HE	90 91 34 701	R/L	324	340	374	431	446	474	519	571	-		
															
906	 <p><b>Corner wall unit</b> side length 60 x 60 cm 2 doors 90.6 cm (20 cm wide) Right door with corner angle 5.6 x 5.6 cm 3 adjustable shelves</p>		HE 60 91 34 75		321	338	389	469	482	506	558	614	-		
			 <p> <b>width 20 cm:</b> FRAME, VILLAGE 15-S, VILLAGE 15-B, CHALET-S, CHALET-B, OSLO 15, TESSIN 15, BERGEN, LUGANO, CASTELLO, VIVA, TIM 15 are supplied with smooth fronts.</p>												

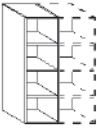

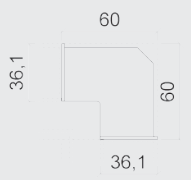
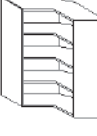
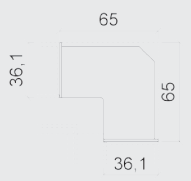
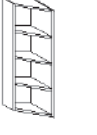
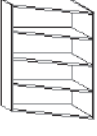



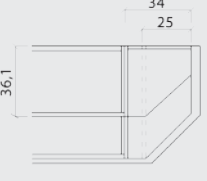

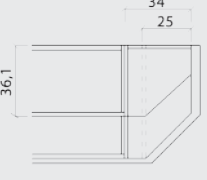
# Corner wall units 91 cm high

Carcase depth 34 cm

		Order no.		W H D		Hinge side:	Carcase depth	Price groups								
								1	2	3	4	5	6	7	8	9
906	 <p><b>Corner wall unit</b> side length 65 x 65 cm 2 doors 90.6 cm (25 cm wide) Right door with corner angle 5.6 x 5.6 cm 3 adjustable shelves</p>		<b>HE</b>	<b>65 91</b>	<b>34 75</b>			395	412	462	537	555	582	641	705	-
								 <b>width 25 cm: FRAME</b> are supplied with smooth fronts.								
																
906	 <p><b>Corner wall unit</b> side length 70 x 70 cm 2 doors 90.6 cm (30 cm wide)</p>		<b>HE</b>	<b>70 91</b>	<b>34 75</b>			735	760	860	1006	1034	1087	1199	1319	-
								 For configurations with base unit carcasse depth 60.5 cm and worktop depth 65 cm.								
																
906	 <p><b>Corner wall unit</b> side length 80 x 80 cm 2 doors 90.6 cm (40 cm wide) Right door with corner angle 5.6 x 5.6 cm 3 adjustable shelves</p>		<b>HE</b>	<b>80 91</b>	<b>34 75</b>			746	771	871	1018	1045	1098	1211	1332	-
																
906	 <p><b>Corner wall unit</b> side length 90 x 90 cm 2 doors 90.6 cm (50 cm wide) Right door with corner angle 5.6 x 5.6 cm 3 adjustable shelves</p>		<b>HE</b>	<b>90 91</b>	<b>34 75</b>			774	800	908	1058	1087	1144	1257	1383	-
																
906	 <p><b>Diagonal corner wall unit</b> side length 60 x 60 cm 1 door 90.6 cm (30 cm wide) 3 adjustable shelves</p>		<b>HDE</b>	<b>60 91</b>	<b>70</b>	R/L		381	389	413	505	530	558	615	677	-
								 <b>Not available for:</b> ALU TEC RP								
																
906	 <p><b>Diagonal corner wall unit</b> side length 65 x 65 cm 1 door 90.6 cm (40 cm wide) 3 adjustable shelves</p>		<b>HDE</b>	<b>65 91</b>	<b>70</b>	R/L		381	389	413	505	530	558	615	677	-
								 <b>Not available for:</b> ALU TEC RP								
																

# Wall shelf units 91 cm high

Carcase depth 36.1 cm


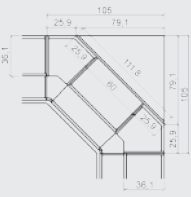




		Order no. W H D	Hinge side: Carcase depth	Decor groups								
				M10	M20	M30	M40	M50	M60	M70	M80	M90
 <p><b>Wall shelf unit</b> 3 adjustable shelves wide in cm: 13-30 wide in cm: 30,1-40 wide in cm: 40,1-45 wide in cm: 45,1-50 wide in cm: 50,1-60 wide in cm: 60,1-80 wide in cm: 80,1-90</p>		<b>HR 30 91 36</b>		192	-	-	-	718	-	718	718	-
		<b>HR 40 91 36</b>		192	-	-	-	718	-	718	718	-
		<b>HR 45 91 36</b>		192	-	-	-	718	-	718	718	-
		<b>HR 50 91 36</b>		192	-	-	-	718	-	718	718	-
		<b>HR 60 91 36</b>		192	-	-	-	718	-	718	718	-
		<b>HR 80 91 36</b>		251	-	-	-	812	-	1046	1046	-
		<b>HR 90 91 36</b>		251	-	-	-	812	-	1046	1046	-
	 <p><b>Corner wall shelf unit</b> side length 60 x 60 cm 3 adjustable shelves</p>		<b>HRE 60 91 36</b>		301	-	-	-	1393	-	1393	1393
												
 <p><b>Corner wall shelf unit</b> side length 65 x 65 cm 3 adjustable shelves</p>		<b>HRE 65 91 36</b>		374	-	-	-	1537	-	1537	1537	-
												
 <p><b>Wall shelf unit angled by 37.2°</b> 25 cm wide 3 adjustable shelves For adjacent fitting left or right</p>		<b>HRS 25 91 36</b>	R/L	226	-	-	-	640	-	640	640	-
 <p><b>Wall shelf unit 15-60 cm</b> Shelves angled at front 3 fixed shelves</p>		<b>HRS 00 91 36</b>	R/L	264	-	-	-	940	-	940	940	-
		 <b>Important!</b> Please state right and left carcase depth (minimum depth 10 cm)										
 <p><b>Wall shelf end unit</b> 25 x 36.1 cm 3 fixed shelves For adjacent fitting left or right</p>		<b>HRA 25 91 36</b>	R/L	208	-	-	-	541	-	541	541	-
		 <b>Important! Only available in 25 cm width</b> 										
 <p><b>Wall shelf end unit</b> 34 x 36.1 cm 3 fixed shelves For adjacent fitting left or right</p>		<b>HRA 34 91 36</b>	R/L	208	-	-	-	625	-	625	625	-
												

# Wall shelf units 91 cm high

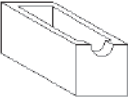
Carcase depth 36.1 cm

Hinge side:	Carcase depth	Decor groups								
		M10	M20	M30	M40	M50	M60	M70	M80	M90

Order no.  
W H D

 <p><b>Wall unit corner solution</b> Spacefitter shelf unit 3 fixed shelves This model is intended for corner solution 105 x 105 cm</p>		<b>HRE 26 91 36</b>	147	-	-	-	668	-	-	-	-
		 Only in conjunction with carcass decor group K									
 <p><b>Flour, sugar and rice scoops in carcass decors</b> including 3 lead-crystal scoops Capacity 750 ml, crystal clear for installing below wall units or for featuring in wall units Size (W x H x D) 36.8 x 13. x 17. cm</p>		<b>SR 37 13 17</b>	546	-	-	-	-	-	-	-	-
		 Only in conjunction with carcass decor group K									
 <p><b>Wall shelf unit for containers</b> 15 cm wide, Prepared for 6 containers</p>		<b>HRSK 15 91 36</b>	211	-	-	-	548	-	548	548	-
<b>M 10</b>	<b>M 20</b>	<b>M 30</b>	<b>M 40</b>				<b>M 50</b>				
K M10 laminate									B M50 Velvet lacquer		S M50 microstructure lacquer
<b>M 60</b>	<b>M 70</b>	<b>M 80</b>	<b>M 90</b>								
	F M70 veneer / oak / walnut Z M70 Veneer / Bavaria	H M80 high gloss-Lacquer MP M80 laqué mat Premium									

## Container

 <p><b>Container, 11 cm high</b> for 15 cm wide shelf unit</p>		<b>SKH 15 13</b>	-	-	-	-	159	-	159	-	-
<b>M 10</b>	<b>M 20</b>	<b>M 30</b>	<b>M 40</b>				<b>M 50</b>				
									B M50 Velvet Lacquer		S M50 Microstructure Lacquer
<b>M 60</b>	<b>M 70</b>	<b>M 80</b>	<b>M 90</b>								
	F M70 veneer / oak / walnut										

# Wall shelf units 91 cm high Country-house elements

Carcase depth 36.1 cm  
fixed shelves 25 mm with profile at top and bottom

Order no.  
W H D

		Decor groups									
Hinge side:	Carcase depth	M10	M20	M30	M40	M50	M60	M70	M80	M90	
		HRL 30 91 36	-	-	-	-	665	-	-	-	-
		HRL 45 91 36	-	-	-	-	819	-	-	-	-
		HRL 60 91 36	-	-	-	-	996	-	-	-	-
		HRL 90 91 36	-	-	-	-	1335	-	-	-	-
		HRSL 30 91 36	-	-	-	-	922	-	-	-	-
		HRSL 45 91 36	-	-	-	-	1193	-	-	-	-
		HRSL 60 91 36	-	-	-	-	1347	-	-	-	-
		HRSL 90 91 36	-	-	-	-	1849	-	-	-	-
		TEL 45	-	-	-	-	162	-	-	-	-
		TEL 60	-	-	-	-	195	-	-	-	-
		TEL 90	-	-	-	-	236	-	-	-	-
	R/L	HRAL 40 91 36	-	-	-	-	900	-	-	-	-



### Wall shelf unit

Flush with front, depth 36.1 cm  
Grooved back panel  
2 adjustable shelves



### Wall shelf unit with containers

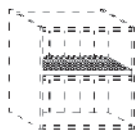
Flush with front, depth 36.1 cm  
Grooved back panel  
1 fixed shelf, 1 adjustable shelf

30 cm width: 1 container

45 cm width: 2 containers

60 cm width: 2 containers

90 cm width: 3 containers



### Plate rack insert

Suitable for shelf widths

45 cm

60 cm

90 cm



### Wall shelf end unit

With 1 pilaster at front with frieze

Width 40 cm, carcass depth 36.1 cm

Flush with front

Grooved back panel and side panel

2 fixed shelves



M 10

M 20

M 30

M 40

M 50

B M50 Velvet Lacquer  
S M50 Microstructure lacquer



M 60

M 70

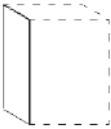



M 80

M 90

## Background filler 91 cm high

		Order no. W H D		Decor groups									
				M10	M20	M30	M40	M50	M60	M70	M80	M90	
	<b>Wall unit background filler</b> Width: 20 cm For fitting flush with carcass	<b>HPSL 00 91</b>			28,40	30	51	68	68	68	68	68	-
	<b>Wall unit side</b> without drill holes for panels e.g. at sides of cooker hoods etc. please state exact height	<b>HS</b>			39	129	176	233	234	244	244	244	-
<b>M 10</b>	<b>M 20</b>	<b>M 30</b>			<b>M 40</b>		<b>M 50</b>						
K M10 laminate	D M20 Laminate decor	I M30 RESOPAL PRO super matt IH M30 HPL PRO PW M30 PRIMEWOOD/Basic Veneer	A M40 DIRECTLACK matt L M40 DIRECTLACK high-gloss		B M50 Velvet lacquer P M50 Soft lacquer S M50 microstructure lacquer								
<b>M 60</b>	<b>M 70</b>	<b>M 80</b>			<b>M 90</b>								
QH M60 SMARTGLAS high-gloss QM M60 SMARTGLAS satin-finish	F M70 veneer / oak / walnut Z M70 Veneer / Bavaria	C1 M80 FENIX stainless-steel look H M80 high gloss-Lacquer MP M80 laqué mat Premium											

## Visible sides / increased side depth 91 cm high

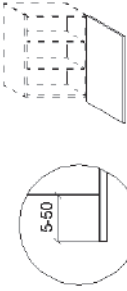


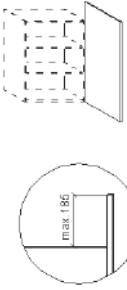


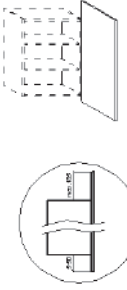


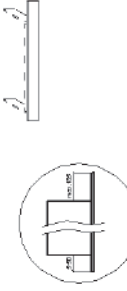

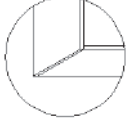



		Order no. W H D		Decor groups									
				M10	M20	M30	M40	M50	M60	M70	M80	M90	
	<b>Wall unit visible side</b>	<b>HSV 91</b>	R/L		0	0	55	55	74	74	83	113	-
					 <b>Important!</b> Installation instead of a normal unit side.								
	<b>Wall unit increased side depth</b> Up to 57.5 cm side depth	<b>HSVT 91</b>	R/L		60	68	123	123	164	164	180	248	-
					 <b>Important!</b> Installation instead of a normal unit side.								
<b>M 10</b>	<b>M 20</b>	<b>M 30</b>			<b>M 40</b>		<b>M 50</b>						
K M10 laminate	D M20 Laminate decor	I M30 RESOPAL PRO super matt IH M30 HPL PRO PW M30 PRIMEWOOD/Basic Veneer	A M40 DIRECTLACK matt L M40 DIRECTLACK high-gloss		B M50 Velvet lacquer P M50 Soft lacquer RH M50 Velvet lacquer wood texture RW M50 Velvet lacquer spackle effect S M50 microstructure lacquer								
<b>M 60</b>	<b>M 70</b>	<b>M 80</b>			<b>M 90</b>								
QH M60 SMARTGLAS high-gloss QM M60 SMARTGLAS satin-finish	F M70 veneer / oak / walnut V M70 Velvet lacquer textured Z M70 Veneer / Bavaria	C1 M80 FENIX stainless-steel look H M80 high gloss-Lacquer MP M80 laqué mat Premium O M80 Veneered											

## Additional equipment

		Order no. W H D		Decor groups									
				M10	M20	M30	M40	M50	M60	M70	M80	M90	
<b>Surcharge for wall cabinets with glass fronts inside and exterior in the same design</b> available in decor groups: S/B/H/MP/F/Z	<b>IDF-H</b>				-	-	-	-	495	-	495	495	-
<b>M 10</b>	<b>M 20</b>	<b>M 30</b>			<b>M 40</b>		<b>M 50</b>						
K M10 laminate					B M50 Velvet lacquer S M50 microstructure lacquer								
<b>M 60</b>	<b>M 70</b>	<b>M 80</b>			<b>M 90</b>								
	F M70 veneer / oak / walnut Z M70 Veneer / Bavaria	H M80 high gloss-Lacquer MP M80 laqué mat Premium											



# Front extension 91 cm high

		Order no. W H D	Hinge side:	Carcase depth	Price groups								
					1	2	3	4	5	6	7	8	9
 <p><b>Extra charge front extension</b> For wall unit doors Can be extended downwards by 5 cm Please note that twice the quantity is needed for 2-door units</p>		<b>FVHU 20</b>			46	49	51	72	98	100	109	120	-
		<b>FVHU 25</b>			46	49	51	72	98	100	109	120	-
		<b>FVHU 30</b>			46	49	51	72	98	100	109	120	-
		<b>FVHU 40</b>			49	50	52	76	105	112	121	133	-
		<b>FVHU 45</b>			50	51	53	78	109	114	123	135	-
		<b>FVHU 50</b>			51	52	54	83	113	120	131	144	-
		<b>FVHU 60</b>			53	54	59	87	118	133	144	158	-
<p> <b>Not available for:</b> MIAMI, VIVA</p> <p> Only available for wall cabinets with hinged doors. The front will be delivered as a separate package. Wall units with glass doors, corner units, diagonal units or angled units are <b>not</b> available with front extension.</p>													
 <p><b>Extra charge front extension</b> For wall unit doors can be extended upwards by maximum 18.5 cm Please note that twice the quantity is needed for 2-door units</p>		<b>FVHO 20</b>			46	49	51	72	98	100	109	120	-
		<b>FVHO 25</b>			46	49	51	72	98	100	109	120	-
		<b>FVHO 30</b>			46	49	51	72	98	100	109	120	-
		<b>FVHO 40</b>			49	50	52	76	105	112	121	133	-
		<b>FVHO 45</b>			50	51	53	78	109	114	123	135	-
		<b>FVHO 50</b>			51	52	54	83	113	120	131	144	-
		<b>FVHO 60</b>			53	54	59	87	118	133	144	158	-
<p> <b>Not available for:</b> MIAMI, VIVA</p> <p> Only available for wall cabinets with hinged doors. The front will be delivered as a separate package. Wall units with glass doors, corner units, diagonal units or angled units are <b>not</b> available with front extension.</p>													
 <p><b>Extra charge front extension</b> For wall unit doors Can be extended upwards and downwards can be extended upwards by maximum 18.5 cm Can be extended downwards by 5 cm Please note that twice the quantity is needed for 2-door units</p>		<b>FVHUO20</b>			89	96	101	144	195	200	216	238	-
		<b>FVHUO25</b>			89	96	101	144	195	200	216	238	-
		<b>FVHUO30</b>			89	96	101	144	195	200	216	238	-
		<b>FVHUO40</b>			96	99	103	155	209	224	241	265	-
		<b>FVHUO45</b>			99	101	107	159	216	228	246	271	-
		<b>FVHUO50</b>			101	103	109	165	226	239	262	288	-
		<b>FVHUO60</b>			107	109	118	175	234	264	290	319	-
<p> <b>Not available for:</b> MIAMI, VIVA</p> <p> Only available for wall cabinets with hinged doors. The front will be delivered as a separate package. Wall units with glass doors, corner units, diagonal units or angled units are <b>not</b> available with front extension.</p>													
 <p><b>Wall unit front filler with front extension</b> Can be extended upwards and downwards can be extended upwards by maximum 18.5 cm Can be extended downwards by 5 cm</p>		<b>HPFV 10 91</b>			102	107	109	178	204	206	215	237	-
		<b>HPFV 20 91</b>			108	112	122	212	237	240	253	278	-
<p> <b>Not available for:</b> MIAMI, VIVA</p>													
 <p><b>Wall unit with full-width bottom structural shelf</b> Requirement: - Wall units up to 100 cm width - Wall units up to 78 cm height - Standard carcass decors decor group K</p>		<b>MP-HDUK</b>			75								
<p> <b>Not available for:</b> Corner wall units with side lengths 60 x 60 cm, 65 x 65 cm, 80 x 80 cm, 90 x 90 cm Wall units with roller shutter Bottom shelves with LED lighting system „UP&amp;DOWN“</p>													
 <p><b>Extra charge for grip ledge on bottom shelf of wall units</b></p>		<b>MP-KBKL</b>			31								
<p> cannot be featured in corner wall units, diagonal units, bevelled units</p>													

# 5.5

## Wall units 104 cm / 117 cm / 130 cm high

Wall units, 104 cm high	XL 5.5.2
Front filler 104 cm	XL 5.5.2
Wall shelf units 104 cm	XL 5.5.2
Background fillers 104 cm	XL 5.5.3
Visible sides / increased side depth 104 cm high	XL 5.5.3
Wall units, 117 cm high	XL 5.5.4
Front filler 117 cm high	XL 5.5.4
Wall shelf units 117 cm high	XL 5.5.4
Background filler 117 cm high	XL 5.5.5
Visible sides / increased side depth 117 cm high	XL 5.5.5
Wall units, 130 cm high	XL 5.5.6
Front filler 130 cm high	XL 5.5.6
Background filler 130 cm high	XL 5.5.6
Visible sides / increased side depth 130 cm high	XL 5.5.6
Front extension 130 cm high	XL 5.5.7

### Legend:



Available with grip ledge N...



Not available with grip ledge N...



This symbol indicates which models are available






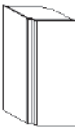
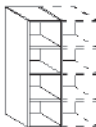
This symbol indicates which models are not available







Planning advice

Heights  
104 / 117 /  
130 cm



## The most important wall unit models 104 cm high

Page XL 5.5.2	Page XL 5.5.2	Page XL 5.5.2	Page XL 5.5.2	Page XL 5.5.2
				
<b>H..103470</b> Unit widths: 30/40/45/50/60	<b>HDI..1034</b> Unit widths: 45/60	<b>HP..10</b> Unit widths: 3,5-20	<b>HPW..104</b> Unit widths: 60X60	<b>HR..1036</b> Unit widths: 30/40/45/50/60

## The most important wall unit models 117 cm high











Page XL 5.5.4	Page XL 5.5.4	Page XL 5.5.4	Page XL 5.5.4
			
<b>H..113470</b> Unit widths: 30/40/45/50/60	<b>HDI..1134</b> Unit widths: 45/60	<b>HP..11</b> Unit widths: 3,5-20	<b>HR..1136</b> Unit widths: 30/40/45/50/60

## The most important wall unit models 130 cm high




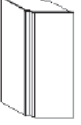
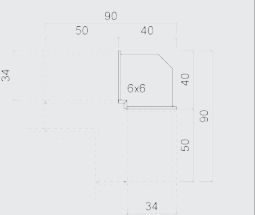
Page XL 5.5.6	Page XL 5.5.6
	
<b>H..133470</b> Unit widths: 30/40/45/50/60	<b>HP..13</b> Unit widths: 3,5-20

## Wall units, 104 cm high

Carcase depth 34 cm

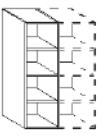
		Order no. W H D		Hinge side: R/L	Carcase depth	Price groups									
						1	2	3	4	5	6	7	8	9	
 <p><b>Wall unit</b> 1 door 103.6 cm 3 adjustable shelves</p>	H	30	10	34	70	R/L	195	202	215	323	329	343	372	409	-
	H	40	10	34	70	R/L	214	220	239	342	365	377	416	458	-
	H	45	10	34	70	R/L	214	220	239	349	373	392	422	464	-
	H	50	10	34	70	R/L	225	233	254	364	392	410	445	490	-
	H	60	10	34	70	R/L	241	257	277	408	440	457	502	552	-
		 Width 30, 40, 45, 50 Not available for: <i>MIAMI, VIVA</i>  Width 60													
 <p><b>Cable compartment for on-site installation in wall units</b> below top shelf for accommodating electrical items such as converters, cables etc. Consisting of left-hand and right-hand sides and bottom shelf Panel removable With ventilation grille</p>	KF	45					138								
	KF	50					138								
	KF	60					138								
		 Finish: decor group K  Suitable for unit models with side-hung doors													
 <p><b>Wall unit for cooker hoods</b> <b>For integrated cooker hoods</b> 1 door 103.6 cm 3 adjustable shelves with chrome-plated rail (number of adjustable shelves depends on appliance)</p>	HDI	45	10	34		R/L	326	339	359	484	519	538	589	648	-
	HDI	60	10	34		R/L	326	341	361	487	524	546	598	658	-
			 Width 45 Not available for: <i>MIAMI, VIVA</i>  Width 60  Please indicate appliance type and manufacturer when ordering.												

## Front filler 104 cm



 <p><b>Wall unit front filler</b> 3.5 - 10 cm 10.1 - 20 cm</p>	HP	10	10				63	63	63	118	118	118	129	142	-
	HP	20	10				67	68	75	154	154	154	166	183	-
<p><b>Wall unit intermediate filler</b> 3.5 - 20 cm</p>	HPZ	20	10				68	68	75	154	154	154	169	186	-
			 Not available for:  <i>MIAMI, VIVA</i>												
 <p><b>Wall unit corner filler</b> 26 x 26 cm, with top and bottom shelf can be used instead of a 60 x 60 cm corner wall unit. Corner dimensions: from 6 x 6 cm (planning dimensions 40 x 40 cm) up to 26 x 26 cm (planning dimensions 60 x 60 cm) available</p>	HPW	26	104				290	311	360	443	462	490	541	595	-
															

## Wall shelf units 104 cm

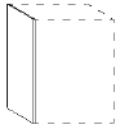



Carcase depth 36.1 cm

		Order no. W H D		Hinge side: R/L	Carcase depth	Decor groups									
						M10	M20	M30	M40	M50	M60	M70	M80	M90	
 <p><b>Wall shelf unit</b> 3 adjustable shelves wide in cm: 13-30 wide in cm: 30,1-40 wide in cm: 40,1-45 wide in cm: 45,1-50 wide in cm: 50,1-60</p>	HR	30	10	36		235	-	-	-	762	-	762	762	-	
	HR	40	10	36		235	-	-	-	762	-	762	762	-	
	HR	45	10	36		235	-	-	-	762	-	762	762	-	
	HR	50	10	36		235	-	-	-	762	-	762	762	-	
	HR	60	10	36		235	-	-	-	762	-	762	762	-	
<b>M 10</b> K M10 laminate	<b>M 20</b>	<b>M 30</b>	<b>M 40</b>	<b>M 50</b> B M50 Velvet lacquer S M50 microstructure lacquer											
<b>M 60</b>	<b>M 70</b> F M70 veneer / oak / walnut Z M70 Veneer / Bavaria	<b>M 80</b> H M80 high gloss-Lacquer MP M80 laqué mat Premium	<b>M 90</b>												

# Background fillers 104 cm






		Order no. W H D	Hinge side: Carcase depth	Decor groups								
				M10	M20	M30	M40	M50	M60	M70	M80	M90
	<b>Wall unit background filler</b> Width: 20 cm For fitting flush with carcass	<b>HPSL 00 10</b>		30	31	53	71	71	71	71	71	-
	<b>Wall unit side</b> without drill holes for panels e.g. at sides of cooker hoods etc. please state exact height	<b>HS</b>		39	129	176	233	234	244	244	244	-
<b>M 10</b>	<b>M 20</b>	<b>M 30</b>	<b>M 40</b>	<b>M 50</b>								
K M10 laminate	D M20 Laminate decor	I M30 RESOPAL PRO super matt IH M30 HPL PRO PW M30 PRIMEWOOD/Basic Veneer	A M40 DIRECTLACK matt L M40 DIRECTLACK high-gloss	B M50 Velvet lacquer P M50 Soft lacquer S M50 microstructure lacquer								
<b>M 60</b>	<b>M 70</b>	<b>M 80</b>	<b>M 90</b>									
QH M60 SMARTGLAS high-gloss QM M60 SMARTGLAS satin-finish	F M70 veneer / oak / walnut Z M70 Veneer / Bavaria	C1 M80 FENIX stainless-steel look H M80 high gloss-Lacquer MP M80 laqué mat Premium										

## Visible sides / increased side depth 104 cm high

	<b>Wall unit visible side</b>	<b>HSV 10</b>	R/L	0	0	60	60	80	80	91	124	-
		 <b>Important!</b> Installation instead of a normal unit side.										
	<b>Wall unit increased side depth</b> Up to 57.5 cm side depth	<b>HSV T 10</b>	R/L	64	72	136	136	180	180	195	273	-
		 <b>Important!</b> Installation instead of a normal unit side.										
<b>M 10</b>	<b>M 20</b>	<b>M 30</b>	<b>M 40</b>	<b>M 50</b>								
K M10 laminate	D M20 Laminate decor	I M30 RESOPAL PRO super matt IH M30 HPL PRO PW M30 PRIMEWOOD/Basic Veneer	A M40 DIRECTLACK matt L M40 DIRECTLACK high-gloss	B M50 Velvet lacquer P M50 Soft lacquer RH M50 Velvet lacquer wood texture RW M50 Velvet lacquer spackle effect S M50 microstructure lacquer								
<b>M 60</b>	<b>M 70</b>	<b>M 80</b>	<b>M 90</b>									
QH M60 SMARTGLAS high-gloss QM M60 SMARTGLAS satin-finish	F M70 veneer / oak / walnut V M70 Velvet lacquer textured Z M70 Veneer / Bavaria	C1 M80 FENIX stainless-steel look H M80 high gloss-Lacquer MP M80 laqué mat Premium O M80 Veneered										



## Wall units, 117 cm high

Carcase depth 34 cm

		Order no.		Hinge side:	Carcase depth	Price groups											
		W	H			D	1	2	3	4	5	6	7	8	9		
1166 	<b>Wall unit</b> 1 door 116.6 cm 3 adjustable shelves	<b>H</b>	<b>30</b>	<b>11</b>	<b>34</b>	<b>70</b>	R/L	235	242	258	364	369	385	414	455	-	
		<b>H</b>	<b>40</b>	<b>11</b>	<b>34</b>	<b>70</b>	R/L	257	262	281	384	407	419	457	503	-	
		<b>H</b>	<b>45</b>	<b>11</b>	<b>34</b>	<b>70</b>	R/L	257	262	281	391	416	432	464	510	-	
		<b>H</b>	<b>50</b>	<b>11</b>	<b>34</b>	<b>70</b>	R/L	267	276	295	406	432	451	487	536	-	
		<b>H</b>	<b>60</b>	<b>11</b>	<b>34</b>	<b>70</b>	R/L	283	297	319	448	481	499	543	597	-	
	<b>Cable compartment for on-site installation in wall units</b> below top shelf for accommodating electrical items such as converters, cables etc. Consisting of left-hand and right-hand sides and bottom shelf Panel removable With ventilation grille	<b>KF</b>	<b>45</b>					138									
		<b>KF</b>	<b>50</b>					138									
		<b>KF</b>	<b>60</b>					138									
		 <i>Finish: decor group K</i> <i>Suitable for unit models with side-hung doors</i>															
1166 	<b>Wall unit for cooker hoods</b> <b>For integrated cooker hoods</b> 1 door 116.6 cm 3 adjustable shelves with chrome-plated rail (number of adjustable shelves depends on appliance)	<b>HDI</b>	<b>45</b>	<b>11</b>	<b>34</b>		R/L	367	379	401	526	562	580	632	695	-	
		<b>HDI</b>	<b>60</b>	<b>11</b>	<b>34</b>		R/L	367	383	403	528	565	586	640	704	-	
		 <i>Please indicate appliance type and manufacturer when ordering.</i>															

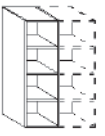
## Front filler 117 cm high

Carcase depth 34 cm

1166 	<b>Wall unit front filler</b> 3.5 - 10 cm 10.1 - 20 cm	<b>HP</b>	<b>10</b>	<b>11</b>				63	63	63	118	118	118	129	142	-
		<b>HP</b>	<b>20</b>	<b>11</b>					67	68	75	154	154	154	166	183
	<b>Wall unit intermediate filler</b> 3.5 - 20 cm	<b>HPZ</b>	<b>20</b>	<b>11</b>				72	72	80	166	166	166	192	211	-
		 <b>Not available for:</b> <i>MIAMI, VIVA</i>														

## Wall shelf units 117 cm high

Carcase depth 36.1 cm



		Order no.		Hinge side:	Carcase depth	Decor groups										
		W	H			D	M10	M20	M30	M40	M50	M60	M70	M80	M90	
	<b>Wall shelf unit</b> 3 adjustable shelves	<b>HR</b>	<b>30</b>	<b>11</b>	<b>36</b>											
		<b>HR</b>	<b>40</b>	<b>11</b>	<b>36</b>		280	-	-	-	806	-	806	806	-	
		<b>HR</b>	<b>45</b>	<b>11</b>	<b>36</b>		280	-	-	-	806	-	806	806	-	
		<b>HR</b>	<b>50</b>	<b>11</b>	<b>36</b>		280	-	-	-	806	-	806	806	-	
		<b>HR</b>	<b>60</b>	<b>11</b>	<b>36</b>		280	-	-	-	806	-	806	806	-	

M 10	M 20	M 30	M 40	M 50
K M10 laminate				B M50 Velvet lacquer S M50 microstructure lacquer
M 60	M 70	M 80	M 90	
	F M70 veneer / oak / walnut Z M70 Veneer / Bavaria	H M80 high gloss-Lacquer MP M80 laqué mat Premium		



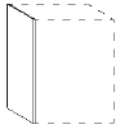



# Background filler 117 cm high

Carcase depth 34 cm

				Decor groups										
		Order no. W H D		Hinge side:	Carcase depth	M10	M20	M30	M40	M50	M60	M70	M80	M90
	<b>Wall unit side</b> without drill holes for panels e.g. at sides of cooker hoods etc. please state exact height	<b>HS</b>				39	129	176	233	234	244	244	244	-
	<b>Wall unit background filler</b> Width: 20 cm For fitting flush with carcass	<b>HPSL 00 11</b>				32	32	55	74	74	74	74	74	-
<b>M 10</b>		<b>M 20</b>		<b>M 30</b>		<b>M 40</b>		<b>M 50</b>						
K M10 laminate		D M20 Laminate decor		I M30 RESOPAL PRO super matt IH M30 HPL PRO PW M30 PRIMEWOOD/Basic Veneer		A M40 DIRECTLACK matt L M40 DIRECTLACK high-gloss		B M50 Velvet lacquer P M50 Soft lacquer S M50 microstructure lacquer						
<b>M 60</b>		<b>M 70</b>		<b>M 80</b>		<b>M 90</b>								
QH M60 SMARTGLAS high-gloss QM M60 SMARTGLAS satin-finish		F M70 veneer / oak / walnut Z M70 Veneer / Bavaria		C1 M80 FENIX stainless-steel look H M80 high gloss-Lacquer MP M80 laqué mat Premium										




# Visible sides / increased side depth 117 cm high

Carcass depth 34 cm


	<b>Wall unit visible side</b>	<b>HSV 11</b>		R/L	0	0	65	65	86	86	100	136	-
		 <b>Important!</b> Installation instead of a normal unit side.											
	<b>Wall unit increased side depth</b> Up to 57.5 cm side depth	<b>HSV T 11</b>		R/L	67	76	145	145	194	194	211	299	-
		 <b>Important!</b> Installation instead of a normal unit side.											
<b>M 10</b>		<b>M 20</b>		<b>M 30</b>		<b>M 40</b>		<b>M 50</b>					
K M10 laminate		D M20 Laminate decor		I M30 RESOPAL PRO super matt IH M30 HPL PRO PW M30 PRIMEWOOD/Basic Veneer		A M40 DIRECTLACK matt L M40 DIRECTLACK high-gloss		B M50 Velvet lacquer P M50 Soft lacquer RH M50 Velvet lacquer wood texture RW M50 Velvet lacquer spackle effect S M50 microstructure lacquer					
<b>M 60</b>		<b>M 70</b>		<b>M 80</b>		<b>M 90</b>							
QH M60 SMARTGLAS high-gloss QM M60 SMARTGLAS satin-finish		F M70 veneer / oak / walnut V M70 Velvet lacquer textured Z M70 Veneer / Bavaria		C1 M80 FENIX stainless-steel look H M80 high gloss-Lacquer MP M80 laqué mat Premium O M80 Veneered									

# Wall units, 130 cm high



Carcase depth 34 cm

		Order no. W H D		Hinge side: R/L	Carcase depth	Price groups									
						1	2	3	4	5	6	7	8	9	
 <p><b>Wall unit</b> 1 door 129.6 cm 3 adjustable shelves With 2 heavy-load fitting sets</p>	<b>H</b>	<b>30</b>	<b>13</b>	<b>34</b>	<b>70</b>	R/L	478	523	593	621	660	687	724	796	-
	<b>H</b>	<b>40</b>	<b>13</b>	<b>34</b>	<b>70</b>	R/L	489	534	604	632	672	699	736	810	-
	<b>H</b>	<b>45</b>	<b>13</b>	<b>34</b>	<b>70</b>	R/L	500	546	616	644	684	710	747	822	-
	<b>H</b>	<b>50</b>	<b>13</b>	<b>34</b>	<b>70</b>	R/L	511	557	626	655	694	721	760	836	-
	<b>H</b>	<b>60</b>	<b>13</b>	<b>34</b>	<b>70</b>	R/L	524	568	639	667	707	732	771	848	-
 <p><b>Cable compartment for on-site installation in wall units</b> below top shelf for accommodating electrical items such as converters, cables etc. Consisting of left-hand and right-hand sides and bottom shelf Panel removable With ventilation grille</p>	<b>KF</b>	<b>45</b>						138							
	<b>KF</b>	<b>50</b>						138							
	<b>KF</b>	<b>60</b>						138							
	 <i>Finish: decor group K</i> Suitable for unit models with side-hung doors														





## Front filler 130 cm high

		Order no. W H D		Hinge side: R/L	Carcase depth	Decor groups									
						M10	M20	M30	M40	M50	M60	M70	M80	M90	
 <p><b>Wall unit front filler</b> 3.5 - 10 cm 10.1 - 20 cm</p>	<b>HP</b>	<b>10</b>	<b>13</b>				67	67	67	130	130	130	149	164	-
	<b>HP</b>	<b>20</b>	<b>13</b>				71	72	80	165	165	165	189	208	-

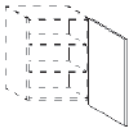
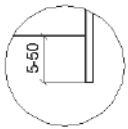


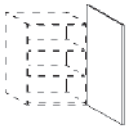
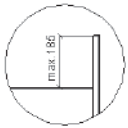


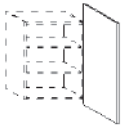






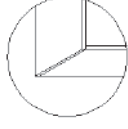



## Background filler 130 cm high

		Order no. W H D		Hinge side: R/L	Carcase depth	Decor groups								
						M10	M20	M30	M40	M50	M60	M70	M80	M90
 <p><b>Wall unit background filler</b> Width: 20 cm For fitting flush with carcass</p>	<b>HPSL 00 13</b>				45	53	75	100	100	100	100	100	100	-
 <p><b>Wall unit side</b> without drill holes for panels e.g. at sides of cooker hoods etc. please state exact height</p>	<b>HS</b>				39	129	176	233	234	244	244	244	244	-
<b>M 10</b>	<b>M 20</b>	<b>M 30</b>	<b>M 40</b>	<b>M 50</b>										
K M10 laminate	D M20 Laminate decor	I M30 RESOPAL PRO super matt IH M30 HPL PRO PW M30 PRIMEWOOD/Basic Veneer	A M40 DIRECTLACK matt L M40 DIRECTLACK high-gloss	B M50 Velvet lacquer P M50 Soft lacquer S M50 microstructure lacquer										
<b>M 60</b>	<b>M 70</b>	<b>M 80</b>	<b>M 90</b>											
QH M60 SMARTGLAS high-gloss QM M60 SMARTGLAS satin-finish	F M70 veneer / oak / walnut Z M70 Veneer / Bavaria	C1 M80 FENIX stainless-steel look H M80 high gloss-Lacquer MP M80 laqué mat Premium												

## Visible sides / increased side depth 130 cm high

		Order no. W H D		Hinge side: R/L	Carcase depth	Decor groups								
						M10	M20	M30	M40	M50	M60	M70	M80	M90
 <p><b>Wall unit visible side</b></p>	<b>HSV 13</b>				0	0	109	109	145	145	181	230	-	
	 <i>Important!</i> Installation instead of a normal unit side.													
 <p><b>Wall unit increased side depth</b> Up to 57.5 cm side depth</p>	<b>HSVT 13</b>				87	116	236	236	316	316	396	500	-	
	 <i>Important!</i> Installation instead of a normal unit side.													
<b>M 10</b>	<b>M 20</b>	<b>M 30</b>	<b>M 40</b>	<b>M 50</b>										
K M10 laminate	D M20 Laminate decor	I M30 RESOPAL PRO super matt IH M30 HPL PRO PW M30 PRIMEWOOD/Basic Veneer	A M40 DIRECTLACK matt L M40 DIRECTLACK high-gloss	B M50 Velvet lacquer P M50 Soft lacquer RH M50 Velvet lacquer wood texture RW M50 Velvet lacquer spackle effect S M50 microstructure lacquer										
<b>M 60</b>	<b>M 70</b>	<b>M 80</b>	<b>M 90</b>											
QH M60 SMARTGLAS high-gloss QM M60 SMARTGLAS satin-finish	F M70 veneer / oak / walnut V M70 Velvet lacquer textured Z M70 Veneer / Bavaria	C1 M80 FENIX stainless-steel look H M80 high gloss-Lacquer MP M80 laqué mat Premium O M80 Veneered												

# Front extension 130 cm high

		Order no. W H D	Hinge side: Carcase depth	Price groups								
				1	2	3	4	5	6	7	8	9
 <p><b>Extra charge front extension</b> For wall unit doors Can be extended downwards by 5 cm Please note that twice the quantity is needed for 2-door units</p> 	<b>FVHU 20</b>	46	49	51	72	98	100	109	120	-		
	<b>FVHU 25</b>	46	49	51	72	98	100	109	120	-		
	<b>FVHU 30</b>	46	49	51	72	98	100	109	120	-		
	<b>FVHU 40</b>	49	50	52	76	105	112	121	133	-		
	<b>FVHU 45</b>	50	51	53	78	109	114	123	135	-		
	<b>FVHU 50</b>	51	52	54	83	113	120	131	144	-		
	<b>FVHU 60</b>	53	54	59	87	118	133	144	158	-		
<p> <b>Not available for:</b> MIAMI, VIVA</p> <p> Only available for wall cabinets with hinged doors. The front will be delivered as a separate package. Wall units with glass doors, corner units, diagonal units or angled units are <b>not</b> available with front extension.</p>												
 <p><b>Extra charge front extension</b> For wall unit doors can be extended upwards by maximum 18.5 cm Please note that twice the quantity is needed for 2-door units</p> 	<b>FVHO 20</b>	46	49	51	72	98	100	109	120	-		
	<b>FVHO 25</b>	46	49	51	72	98	100	109	120	-		
	<b>FVHO 30</b>	46	49	51	72	98	100	109	120	-		
	<b>FVHO 40</b>	49	50	52	76	105	112	121	133	-		
	<b>FVHO 45</b>	50	51	53	78	109	114	123	135	-		
	<b>FVHO 50</b>	51	52	54	83	113	120	131	144	-		
	<b>FVHO 60</b>	53	54	59	87	118	133	144	158	-		
<p> <b>Not available for:</b> MIAMI, VIVA</p> <p> Only available for wall cabinets with hinged doors. The front will be delivered as a separate package. Wall units with glass doors, corner units, diagonal units or angled units are <b>not</b> available with front extension.</p>												
 <p><b>Extra charge front extension</b> For wall unit doors Can be extended upwards and downwards can be extended upwards by maximum 18.5 cm Can be extended downwards by 5 cm Please note that twice the quantity is needed for 2-door units</p> 	<b>FVHUO20</b>	89	96	101	144	195	200	216	238	-		
	<b>FVHUO25</b>	89	96	101	144	195	200	216	238	-		
	<b>FVHUO30</b>	89	96	101	144	195	200	216	238	-		
	<b>FVHUO40</b>	96	99	103	155	209	224	241	265	-		
	<b>FVHUO45</b>	99	101	107	159	216	228	246	271	-		
	<b>FVHUO50</b>	101	103	109	165	226	239	262	288	-		
	<b>FVHUO60</b>	107	109	118	175	234	264	290	319	-		
<p> <b>Not available for:</b> MIAMI, VIVA</p> <p> Only available for wall cabinets with hinged doors. The front will be delivered as a separate package. Wall units with glass doors, corner units, diagonal units or angled units are <b>not</b> available with front extension.</p>												
 <p><b>Wall unit front filler with front extension</b> Can be extended upwards and downwards can be extended upwards by maximum 18.5 cm Can be extended downwards by 5 cm</p>  <p>3.5 - 10 cm height 103 cm 11 - 20 cm height 103 cm 3.5 - 10 cm height 117 cm 11 - 20 cm height 117 cm 3.5 - 10 cm height 130 cm 11 - 20 cm height 130 cm</p>	<p> <b>Not available for:</b> MIAMI, VIVA</p>											
	<b>HPFV 10 10</b>	108	111	113	190	215	217	236	260	-		
	<b>HPFV 20 10</b>	112	117	126	226	252	254	276	304	-		
	<b>HPFV 10 11</b>	110	113	116	198	224	226	253	278	-		
	<b>HPFV 20 11</b>	114	119	129	232	259	261	283	311	-		
	<b>HPFV 10 13</b>	112	116	118	202	228	230	259	285	-		
	<b>HPFV 20 13</b>	117	121	131	237	264	267	297	327	-		
	 <p><b>Wall unit with full-width bottom structural shelf</b> Requirement: - Wall units up to 100 cm width - Wall units up to 78 cm height - Standard carcass decors decor group K</p>	<b>MP-HDUK</b>	75									
		<p> <b>Not available for:</b> Corner wall units with side lengths 60 x 60 cm, 65 x 65 cm, 80 x 80 cm, 90 x 90 cm Wall units with roller shutter Bottom shelves with LED lighting system „UP&amp;DOWN“</p>										
	 <p><b>Extra charge for grip ledge on bottom shelf of wall units</b></p>	<b>MP-KBKL</b>	31									
<p> cannot be featured in corner wall units, diagonal units, bevelled units</p>												



# 5.6

## Chimney hoods, canopy hoods

Chimney hoods, canopy hoods

XL 5.6.1

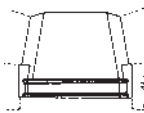






Legend:



Planning advice

Chimney hoods, canopy  
hoods

# Chimney hoods, canopy hoods

		Order no. W H D	Hinge side:	Carcass depth	Decor groups									
					M10	M20	M30	M40	M50	M60	M70	M80	M90	
 <p><b>Canopy hood for corner solution 105 x 105 cm</b> Hood structure untreated for finishing on site Overall heights 204.8 cm / 217.8 cm and 230.8 cm (with 10 cm plinth height) With cornices in corresponding front colour Intermediate panel for tiling on site (please indicate tile height)</p>	<p><b>DEE105-65</b></p>	-	-	946	-	-	-	-	-	-	-			
	<p><b>DEE105-78</b></p>	-	-	946	-	-	-	-	-	-	-			
	<p><b>DEE105-91</b></p>	-	-	946	-	-	-	-	-	-	-			
	<p> Available cornices KL 104 or KL 105</p>													
<p><b>Extra charge Canopy hood for corner solution 105 x 105 cm</b> Hood structure untreated for finishing on site for room height 270 cm Please indicate cutout for cooker hood. In combination with worktop gallery, the base must be ordered in the full depth!</p>	<p><b>DEE/U</b></p>	-	-	0	-	-	-	-	-	-	-			
	<p> Available cornices KL 104 or KL 105</p>													
<p><b>Extra charge Hood structure Micro textured lacquer / velvet lacquer (decor groups S/B)</b></p>	<p><b>MP-HK</b></p>	-	-	-	-	484	-	-	-	-	-			
<p><b>Extra charge Tiling bed micro textured lacquer / velvet lacquer (decor groups S/B)</b></p>	<p><b>MP-FS</b></p>	-	-	-	-	122	-	-	-	-	-			
 <p><b>Canopy hood only in straight rows 80 cm wide</b> Hood structure untreated for finishing on site With cornices in corresponding front colour Intermediate panel for tiling on site (please indicate tile height) max. cutout: W x D 54 x 45 cm</p>	<p><b>DE 80-65</b></p>	-	-	864	-	-	-	-	-	-				
	<p><b>DE 80-78</b></p>	-	-	864	-	-	-	-	-	-				
	<p><b>DE 80-91</b></p>	-	-	864	-	-	-	-	-	-				
	<p> Available cornices KL 104 or KL 105</p>													
<p><b>as above, but Canopy hood only in straight rows 90 cm wide</b> max. cutout: W x D 64 x 45 cm</p>	<p><b>DE 90-65</b></p>	-	-	881	-	-	-	-	-	-				
	<p><b>DE 90-78</b></p>	-	-	881	-	-	-	-	-	-				
	<p><b>DE 90-91</b></p>	-	-	881	-	-	-	-	-	-				
	<p> Available cornices KL 104 or KL 105</p>													
<p><b>as above, but Canopy hood only in straight rows 90.1 - 130 cm wide</b></p>	<p><b>DE 00-65</b></p>	-	-	1130	-	-	-	-	-	-				
	<p><b>DE 00-78</b></p>	-	-	1130	-	-	-	-	-	-				
	<p><b>DE 00-91</b></p>	-	-	1130	-	-	-	-	-	-				
	<p> Available cornices KL 104 or KL 105</p>													
<p><b>Extra charge Hood structure Micro textured lacquer / velvet lacquer (decor groups S/B)</b></p>	<p><b>MP-HK</b></p>	-	-	-	-	484	-	-	-	-				
<p><b>Extra charge Tiling bed micro textured lacquer / velvet lacquer (decor groups S/B)</b></p>	<p><b>MP-FS</b></p>	-	-	-	-	122	-	-	-	-				

## Available cornices for DEK.../ decor groups for hood structures

M 10	M 20	M 30	M 40	M 50
		SP M30 Chipboard raw		B M50 Velvet Lacquer S M50 Microstructure Lacquer
M 60	M 70	M 80	M 90	





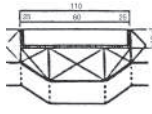
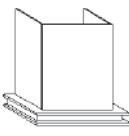
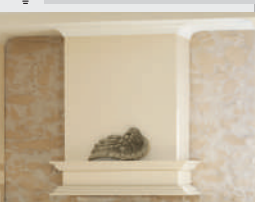
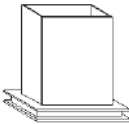
KL 104



KL 105



# Chimney hoods, canopy hoods

		Order no. W H D	Hinge side: R/L	Carcass depth	Decor groups								
					M10	M20	M30	M40	M50	M60	M70	M80	M90
 <p><b>Canopy hood for wall mounting at side 90 - 130 cm wide</b> Hood structure untreated for finishing on site for room height 270 cm 55.5 cm deep max. cutout: with width 120 cm: W 97 cm D 35 cm With cornices in corresponding front colour Intermediate panel for tiling on site (please indicate tile height)</p>	<p><b>DEM 120</b></p> <p>Available cornices KL 104 or KL 105</p> 	R/L	-	-	803	-	-	-	-	-	-	-	
	<p><b>Extra charge</b> <b>Hood structure</b> <b>Micro textured lacquer / velvet lacquer (decor groups S/B)</b></p> <p><b>MP-HK</b></p>			-	-	-	-	484	-	-	-	-	-
<p><b>Extra charge</b> <b>Tiling bed micro textured lacquer / velvet lacquer (decor groups S/B)</b></p> <p><b>MP-FS</b></p>			-	-	-	-	122	-	-	-	-	-	
 <p><b>Mounting wall</b> For fixing set-forward cooker hoods and wall units or shelf units Width: 110 x 19 cm deep</p>	<p><b>MOW 110 52</b></p>		108										
	<p><b>MOW 110 65</b></p>		108										
	<p><b>MOW 110 78</b></p>		108										
	<p><b>MOW 110 91</b></p>		108										
	<p><b>MOW 110 113</b></p>		128										
	<p><b>MOW 110 126</b></p>		128										
	<p><b>MOW 110 139</b></p>		128										
 <p><b>Canopy hood 90 cm wide</b> Hood structure untreated for finishing on site for room height 270 cm With cornices in corresponding front colour Intermediate panel for tiling on site (please indicate tile height) max. cutout: W 62.2 cm D 36.4 cm</p>	<p><b>DEG 90</b></p> <p>Available cornices KL 104 or KL 105</p> 		-	-	1096	-	-	-	-	-	-	-	
	<p>as above, but <b>Canopy hood 90.1 - 130 cm wide</b></p> <p><b>DEG 00</b></p>			-	-	1344	-	-	-	-	-	-	
 <p><b>as above, but</b> <b>Island hood 90 - 130 cm wide</b> Depth from 55.5 - 75 cm max. cutout for width 90 cm/depth 55.5 cm: W 62.2 cm D 28.1 cm</p>	<p><b>DEGI 00</b></p> <p>Available cornices KL 104 or KL 105</p>		-	-	1750	-	-	-	-	-	-	-	
	<p><b>Extra charge</b> <b>Hood structure</b> <b>Micro textured lacquer / velvet lacquer (decor groups S/B)</b></p> <p><b>MP-HK</b></p>			-	-	-	-	484	-	-	-	-	
<p><b>Extra charge</b> <b>Tiling bed micro textured lacquer / velvet lacquer (decor groups S/B)</b></p> <p><b>MP-FS</b></p>			-	-	-	-	122	-	-	-	-		

## Available cornices for DEK.../ decor groups for hood structures

M 10	M 20	M 30	M 40	M 50
		SP M30 Chipboard raw		B M50 Velvet Lacquer S M50 Microstructure Lacquer
M 60	M 70	M 80	M 90	

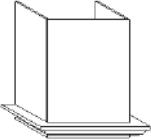
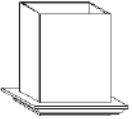


KL 104



KL 105

# Chimney hoods, canopy hoods

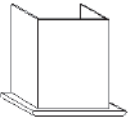
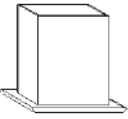
		Order no. W H D	Hinge side: Carcass depth	Decor groups									
				M10	M20	M30	M40	M50	M60	M70	M80	M90	
	<b>Extractor hood 90 cm wide</b> Hood structure untreated for finishing on site for room height 270 cm max. cutout: W 53.8 cm D 32.5 cm With cornice in the corresponding front colour	<b>DEK 90</b>		-	-	1346	-	-	-	-	-	-	-
	Available cornices KL 104 or KL 105												
	<b>as above, but Extractor hood 90.1 - 130 cm wide</b>	<b>DEK 00</b>		-	-	1575	-	-	-	-	-	-	-
	<b>as above, but Island hood 90 - 130 cm wide</b> Depth from 55.5 - 75 cm max. cutout: for width 90 cm/depth 55.5 cm: W 53.8 cm D 19.7 cm	<b>DEKI 00</b>		-	-	2047	-	-	-	-	-	-	-
	Available cornices KL 104 or KL 105												
	<b>Extra charge Hood structure Micro textured lacquer / velvet lacquer (decor groups S/B)</b>	<b>MP-HK</b>		-	-	-	-	484	-	-	-	-	-

## Available cornices for DEK.../ decor groups for hood structures

M 10	M 20	M 30	M 40	M 50
		SP M30 Chipboard raw		B M50 Velvet Lacquer S M50 Microstructure Lacquer
M 60	M 70	M 80	M 90	



# Chimney hoods, canopy hoods

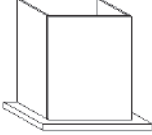
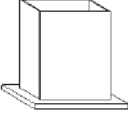
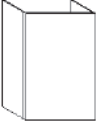

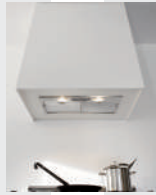
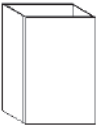
	<b>Canopy hood 90 cm wide</b> Hood structure untreated for finishing on site for room height 270 cm max. cutout: W 63.2 cm D 37.4 cm With cornices in corresponding front colour	<b>DEKK 90</b>		-	-	-	-	1346	-	-	1851	1851
	Available cornices KL 105											
	<b>as above, but Canopy hood 90.1 - 130 cm wide</b>	<b>DEKK 00</b>		-	-	-	-	1575	-	-	2080	2080
	<b>as above, but Island hood 90 - 130 cm wide</b> Depth from 55.5 - 75 cm max. cutout: for width 90 cm/depth 55.5 cm: W 63.2 cm D 28.7 cm	<b>DEKKI 00</b>		-	-	-	-	2047	-	-	2551	2551
	Available cornices KL 105											

## Available cornices for DEKK../ decor groups for hood structures

M 10	M 20	M 30	M 40	M 50
				B M50 Velvet lacquer S M50 Micro textured lacquer
M 60	M 70	M 80	M 90	
		H M80 High-gloss lacquer MP M80 Premium matt lacquer	U M90 Matt lacquer application, gold coloured	



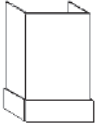

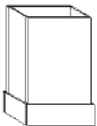
## Chimney hoods, canopy hoods

	Order no. W H D	Hinge side: Carcase depth	Decor groups								
			M10	M20	M30	M40	M50	M60	M70	M80	M90
 <p><b>Extractor hood 90 cm wide with bottom shelf of 5 cm panel material</b> Hood structure untreated for finishing on site for room height 270 cm max. cutout: W 60 cm D 35.4 cm</p>	<b>DEW 90</b>		-	-	934	-	-	-	-	-	-
<p>as above, but <b>Extractor hood 90.1 - 130 cm wide with bottom shelf of 5 cm panel material</b></p>	<b>DEW 00</b>		-	-	1163	-	-	-	-	-	-
 <p>as above, but <b>Island hood 90 - 130 cm wide with bottom shelf of 5 cm panel material</b> Depth from 55.5 - 75 cm max. cutout: for width 90 cm/depth 55.5 cm: W 60 cm D 26.1 cm</p>	<b>DEWI 00</b>		-	-	1657	-	-	-	-	-	
<p><b>Extra charge</b> <b>Hood structure</b> <b>Micro textured lacquer / velvet lacquer (decor groups S/B)</b></p>	<b>MP-HK</b>		-	-	-	-	484	-	-	-	-
 <p><b>Canopy hood 90 cm wide</b> for room height 270 cm depth 55.5 cm max. cutout: W 79.8 cm D 45.4 cm with straight duct Hood structure carcasse decors/ Accessory decors (Decor groups K/D)</p>	<b>DEGR 90</b>		1050	1280	-	-	-	-	-	-	
											
<p>as above, but <b>Canopy hood 90.1 - 130 cm wide</b></p>	<b>DEGR 00</b>		1291	1522	-	-	-	-	-	-	
 <p>as above, but <b>Island hood 90 - 130 cm wide</b> Depth from 55.5 - 75 cm max. cutout for width 90 cm/depth 55.5 cm: W 79.8 cm D 40.8 cm Hood structure carcasse decors/ Accessory decors (Decor groups K/D)</p>	<b>DEGR I00</b>		1680	1910	-	-	-	-	-	-	

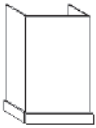


### Decor groups for panel material for cooker hoods DEW..

M 10	M 20	M 30	M 40	M 50
K M10 laminate	D M20 Laminate decor	SP M30 Chipboard raw		B M50 Velvet Lacquer S M50 Microstructure Lacquer
M 60	M 70	M 80	M 90	

## Chimney hoods, canopy hoods

 <p><b>Canopy hood 90 cm wide</b> Hood structure untreated for room height 270 cm depth 55.5 cm max. cutout: W 76 cm D 43.5 cm with straight duct Panels on 3 sides 20 cm high in decor group finish</p>	<b>DEGB 90</b>		1075	1142	-	-	1184	-	1420	-	-
											
<p>as above, but <b>Canopy hood 90.1 - 130 cm wide</b></p>	<b>DEGB 00</b>		1324	1411	-	-	1455	-	1750	-	-
 <p>as above, but <b>Island hood 90 - 130 cm wide</b> Depth 55.5 cm - 75.0 cm max. cutout: for width 90 cm/depth 55.5 cm: W 76 cm D 37 cm Panels on 4 sides 20 cm high in decor group finish</p>	<b>DEGBI 00</b>		1718	1843	-	-	1891	-	2274	-	-
<p><b>Extra charge</b> <b>Hood structure</b> <b>Micro textured lacquer / velvet lacquer (decor groups S/B)</b></p>	<b>MP-HK</b>		-	-	-	-	484	-	-	-	-

# Chimney hoods, canopy hoods

		Order no. W H D	Hinge side: Carcass depth	Decor groups								
				M10	M20	M30	M40	M50	M60	M70	M80	M90
	<b>Canopy hood 90 cm wide</b> Hood structure untreated for room height 270 cm depth 55.5 cm max. cutout: W 76 cm D 43.5 cm with straight duct Panels on 3 sides 10 cm high in decor group finish	<b>DEGBS90</b>		1075	1142	-	-	1184	-	1420	-	-
												
	<b>as above, but Canopy hood 90.1 - 130 cm wide</b>	<b>DEGBS00</b>		1324	1411	-	-	1455	-	1750	-	-
	<b>as above, but Island hood 90 - 130 cm wide</b> Depth 55.5 cm - 75.0 cm max. cutout: for width 90 cm/depth 55.5 cm: W 76 cm D 37 cm Panels on 4 sides 10 cm high in decor group finish	<b>DEGBSI00</b>		1718	1843	-	-	1891	-	2274	-	-
	<b>Extra charge Hood structure Micro textured lacquer / velvet lacquer (decor groups S/B)</b>	<b>MP-HK</b>		-	-	-	-	484	-	-	-	-

## Decor groups panels for panels on hoods DEGB..

M 10	M 20	M 30	M 40	M 50
K M10 laminate	D M20 Laminate decor			B M50 Velvet Lacquer S M50 Microstructure Lacquer
M 60	M 70	M 80	M 90	
	F M70 veneer / oak / walnut			

## Push-fit shelves


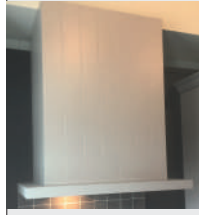
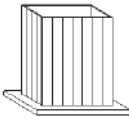

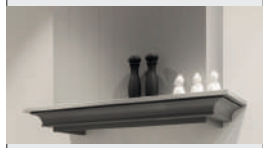

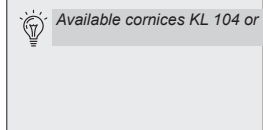
	<b>Push-fit shelf</b> 18 cm deep, 10 cm thick With concealed mounting fitting, Angular construction Max. length 260 cm, min. length 23 cm	per 10 cm Width <b>WSBW100 18</b> minimum price		41 120	-	-	-	-	-	-	-	-
		<b>Push-fit shelf</b> 18 cm deep, 10 cm thick With concealed mounting fitting, at the sides Max. length 260 cm, min. length 23 cm	per 10 cm Width <b>WSB 100 18</b> minimum price		-	-	-	-	57 183	-	70 218	-

## Decor group for push-fit shelf

M 10	M 20	M 30	M 40	M 50
K100 M10 Laminate 100 mm				B100 M50 Velvet Lacquer 100 mm S100 M50 Micro struct. lacq. 100 mm
M 60	M 70	M 80	M 90	
	F100 M70 veneer / oak 100 mm Z100 M70 veneer / Bavaria 100 mm			



## Chimney hoods, canopy hoods

	Order no. W H D	Hinge side: Carcase depth	Decor groups								
			M10	M20	M30	M40	M50	M60	M70	M80	M90
 <p><b>Extractor hood 90 cm wide with bottom shelf of 5 cm panel material</b> for room height 270 cm max. cutout: W 60 cm D 35.4 cm Panels and hood structure in same colour veneered or lacquered</p>	<b>DEWR 90</b>		-	-	-	-	1561	-	1561	-	-
											
	<b>as above, but Extractor hood 90.1 - 130 cm wide with bottom shelf of 5 cm panel material</b>	<b>DEWR 00</b>	-	-	-	-	1821	-	1821	-	-
 <p><b>as above, but Island hood 90 - 130 cm wide with bottom shelf of 5 cm panel material</b> Depth from 55.5 - 75 cm max. cutout: for width 90 cm/depth 55.5 cm: W 60 cm D 26.1 cm</p>	<b>DEWRI00</b>		-	-	-	2367	-	2367	-	-	
 <p><b>Extractor hood 90 cm wide Hood structure micro textured lacquer with grooves</b> for room height 270 cm max. cutout: W 53.8 cm D 32.5 cm With cornice in the corresponding front colour</p>	<b>DEKR 90</b>		-	-	-	1973	-	-	-	-	
			Available cornices KL 104 or KL 105								
	<b>as above, but Extractor hood 90.1 - 130 cm wide Hood structure micro textured lacquer with grooves</b>	<b>DEKR 00</b>	-	-	-	-	2230	-	-	-	-
 <p><b>as above, but Island hood 90 - 130 cm wide Hood structure micro textured lacquer with grooves</b> Depth 55.5 cm - 75.0 cm max. cutout: for width 90 cm/depth 55.5 cm: W 53.8 cm D 19.7 cm</p>	<b>DEKRI 00</b>		-	-	-	2899	-	-	-	-	
			Available cornices KL 104 or KL 105								

### Available cornices for DEKR..

M 10	M 20	M 30	M 40	M 50
		SP M30 Chipboard raw		B M50 Velvet Lacquer S M50 Microstructure Lacquer
M 60	M 70	M 80	M 90	
	F M70 veneer / oak / walnut			

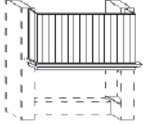
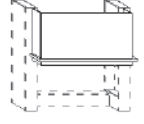


KL 104



KL 105

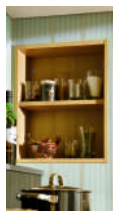
## Chimney hoods, canopy hoods

 <p><b>Canopy hood for stiles 125-180 cm wide</b> Hood structure with front material for room height 270 cm 55.5 - 69.5 cm deep Clear distance to lower edge light pelmet 70 cm</p>			With cornices in corresponding front colour (KL 105 only) and light pelmet (only LB 101)								
 <p>Micro textured lacquer / velvet lacquer smooth Micro textured lacquer / velvet lacquer groove 10 cm Micro textured lacquer / velvet lacquer groove 15 cm Hood structure untreated</p>	<b>DEA180-70-3</b>		-	-	-	-	2861	-	-	-	-
	<b>DEA180-70-31</b>		-	-	-	-	2861	-	-	-	-
	<b>DEA180-70-32</b>		-	-	-	-	2861	-	-	-	-
	<b>DEA180-70</b>		-	-	1300	-	-	-	-	-	-

# Chimney hoods, canopy hoods

Order no.  
W H D

Hinge side:	Carcase depth	Decor groups								
		M10	M20	M30	M40	M50	M60	M70	M80	M90



## Available cornices for DEGS.../ decor groups for hood structures

M 10	M 20	M 30	M 40	M 50
	SP M30 Chipboard raw			B M50 Velvet Lacquer S M50 Microstructure Lacquer
M 60	M 70	M 80	M 90	
	F M70 veneer / oak / walnut			



KL 105



LB101

## Chimney hoods, canopy hoods

<p><b>Stile untreated for finishing on site</b> Stile width 15 cm, stile depth 44 cm for configurations with worktop depth 75 cm</p>	AS 15 45					-	-	214	-	-	-	-	-	-
	AS 15 30					-	-	214	-	-	-	-	-	-
	ASR 20 45						-	-	374	-	-	-	-	-
<p><b>Stile untreated for finishing on site</b> Stile width 15 cm, stile depth 30 cm for configurations with worktop depth 60 cm</p> <p><b>Stile untreated for finishing on site prepared for shelf units</b> Stile width 20 cm, stile depth 44 cm (shelf unit dimensions height 52 cm, width 40 cm, depth 18 cm)</p>														

## Decor group for stiles

M 10	M 20	M 30	M 40	M 50	M 60	M 70	M 80	M 90
			D098N Hood structure untreated					

## Shelf units 52 cm high

<p><b>Shelf unit for stiles</b> 1 adjustable shelf, 18 cm deep</p>	HR 40 52 18					191	-	-	-	552	-	-	-	-

M 10	M 20	M 30	M 40	M 50
K M10 laminate				B M50 Velvet Lacquer S M50 Microstructure Lacquer
M 60	M 70	M 80	M 90	

## Chimney hoods, canopy hoods

<p><b>Gallery for canopy hood with stiles</b> Dimensions: height 20 cm, depth 15 cm 1.6 cm material thickness</p>	per 10 cm Width													
	EM 20 15	R/L	15,30	25,30	-	-	42	-	42	-	-			

# Chimney hoods, canopy hoods

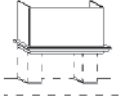
Order no.  
W H D

Hinge side: Carcass depth	Decor groups								
	M10	M20	M30	M40	M50	M60	M70	M80	M90

## Decor groups Gallery for stiles

<b>M 10</b> K M10 laminate	<b>M 20</b> D M20 Laminate decor	<b>M 30</b>	<b>M 40</b>	<b>M 50</b> B M50 Velvet Lacquer S M50 Microstructure Lacquer
<b>M 60</b>	<b>M 70</b> F M70 veneer / oak / walnut	<b>M 80</b>	<b>M 90</b>	

# Chimney hoods, canopy hoods



**Canopy hood for unit elements**  
Extractor hood 150-200 cm wide  
for room height 270 cm  
depth 55.5 cm  
with straight duct, hood structure untreated  
Clear distance to lower edge  
Light pelmet 67.5 cm  
Incl. 4 panel shelves 2.5 cm  
2 panel shelves 2.5 cm:  
on top of the wall unit  
2 panel shelves 2.5 cm:  
under the wall unit  
in same colour finish as  
cornice / light pelmet

### DEGS200-55



With cornices in corresponding front colour (KL 105 only) and light pelmet (only LB 101)

## Available cornices for DEGS.../ decor groups for hood structures

<b>M 10</b>	<b>M 20</b>	<b>M 30</b> SP M30 Chipboard raw	<b>M 40</b>	<b>M 50</b> B M50 Velvet Lacquer S M50 Microstructure Lacquer
<b>M 60</b>	<b>M 70</b> F M70 veneer / oak / walnut	<b>M 80</b>	<b>M 90</b>	



KL 105



LB101



**Canopy hood for unit elements**  
Extractor hood 150-200 cm wide  
for room height 270 cm  
depth 55.5 cm  
With cornices in corresponding front colour  
with straight duct, hood structure untreated  
Clear distance to lower edge chimney hood 70  
cm  
Incl. 4 panel shelves 2.5 cm  
2 panel shelves 2.5 cm:  
on top of the wall unit  
2 panel shelves 2.5 cm:  
under the wall unit in same colour finish as  
cornice / light pelmet

### DEGSK200-55



Available cornices KL 105

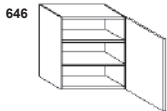
## Available cornices for DEKK.../ decor groups for hood structures

<b>M 10</b>	<b>M 20</b>	<b>M 30</b>	<b>M 40</b>	<b>M 50</b> B M50 Velvet lacquer S M50 Micro textured lacquer	<b>M 60</b>	<b>M 70</b>	<b>M 80</b> H M80 High-gloss lacquerMP M80 Pre- mium matt lacquer	<b>M 90</b> U M90 Matt lacquer application, gold coloured
-------------	-------------	-------------	-------------	--	-------------	-------------	--	--



KL 105

# Chimney hoods, canopy hoods



**Must be planned:**  
**Wall unit**  
1 door 64.6 cm  
2 adjustable shelves

### H 30 65 34 70



R/L	128	136	147	186	202	204	218	240	-
-----	-----	-----	-----	-----	-----	-----	-----	-----	---



# 5.7

## Dresser units

Dresser units, 113 cm high	XL 5.7.1-XL 5.7.2
Dresser units, 113 cm high with glass fronts	XL 5.7.2
Additional equipment	XL 5.7.2
Dresser units, 113 cm high with roller shutter	XL 5.7.3
Dresser units, 119.5 cm high	XL 5.7.4
Dresser units, 119.5 cm high with glass fronts	XL 5.7.5
Additional equipment	XL 5.7.5
Dresser units, 119.5 cm high with roller shutter	XL 5.7.6
Dresser units, 126 cm high	XL 5.7.7-XL 5.7.8
Dresser units, 126 cm high with glass fronts	XL 5.7.8
Dresser units, 126 cm high with roller shutter	XL 5.7.9
Dresser units, 132.5 cm high	XL 5.7.10
Dresser units, 132.5 cm high with glass fronts	XL 5.7.11
Additional equipment	XL 5.7.11
Dresser units, 132.5 cm high with roller shutter	XL 5.7.12
Dresser units, 139 cm high	XL 5.7.13-XL 5.7.14
Dresser units, 139 cm high with glass fronts	XL 5.7.14
Additional equipment	XL 5.7.14
Dresser units, 139 cm high with roller shutter	XL 5.7.15
Dresser units, 145.5 cm high	XL 5.7.16
Dresser units, 145.5 cm high with glass fronts	XL 5.7.17
Additional equipment	XL 5.7.17
Dresser units, 145.5 cm high with roller shutter	XL 5.7.18
Dresser units Shelf units	XL 5.7.19
Dresser units Processing	XL 5.7.20
Dresser units Lighting	XL 5.7.21
Dresser units Background filler	XL 5.7.22
Dresser units Visible sides	XL 5.7.22

### Legend:



Available with grip ledge N...



Not available with grip ledge N...



This symbol indicates which models are available



This symbol indicates which models are not available



wall-mounted units



available depths for wall-mounted units



Planning advice



Available carcass depths 34/45.5/55.5/61.0 cm



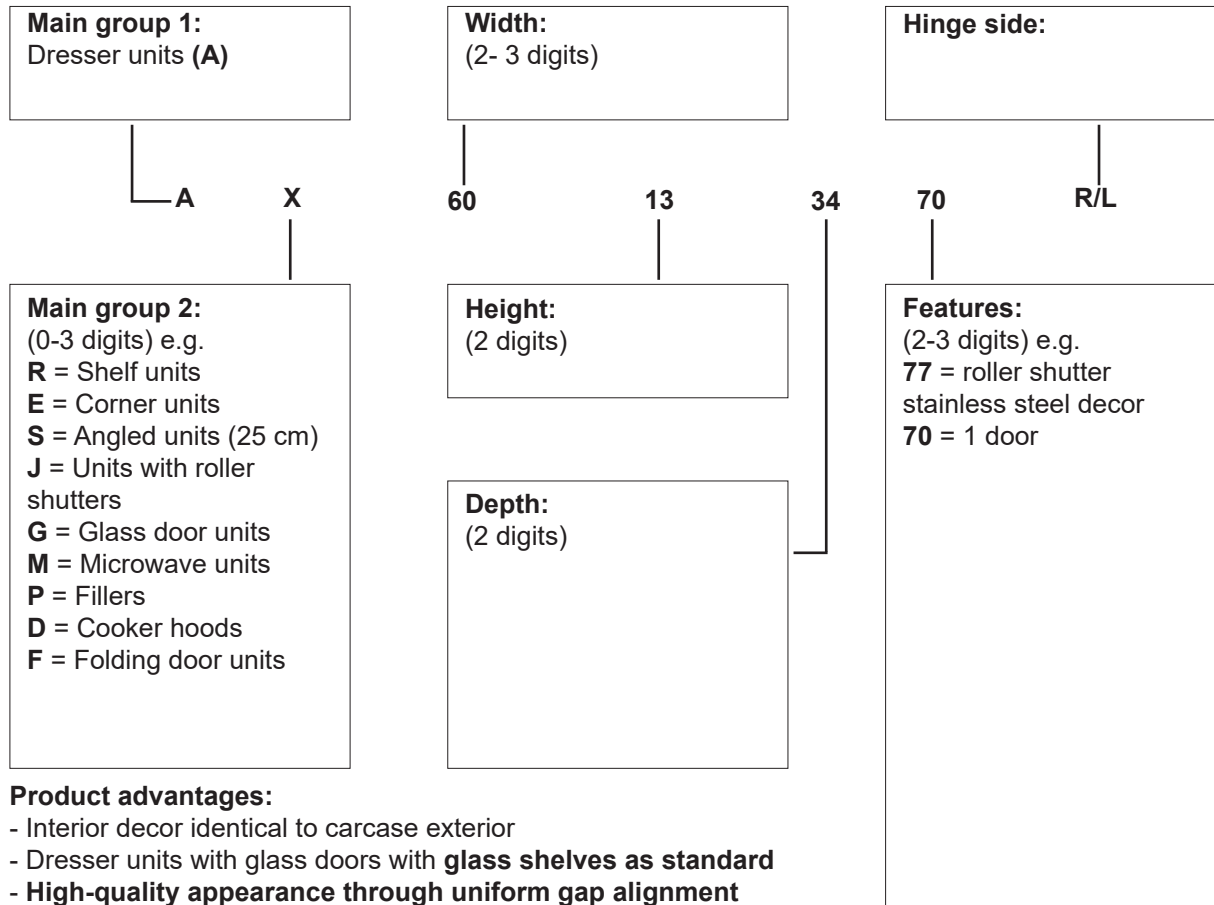
Available carcass depths 45.5/55.5/61.0 cm



Models also available in 63.3 cm carcass depth

# Technical information - top-mounted units

## Explanation of order number



Dresser units

### Product advantages:

- Interior decor identical to carcass exterior
- Dresser units with glass doors with **glass shelves as standard**
- **High-quality appearance through uniform gap alignment**
- Full-depth shelves with anti-tilting safety device
- Units with roller shutter in 50-60-80-90 cm width

### Special features:

- Dresser units with glass roller shutter available in different finishes



**Type:**  
SMARTGLAS tambour door


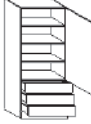


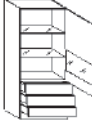

















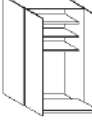




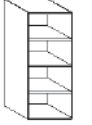
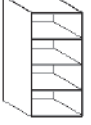
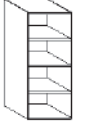
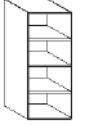
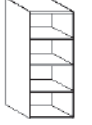
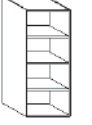


**Finish:**  
Roller shutters black laminate

# Dresser units

Page XL 5.7.1	Page XL 5.7.1	Page XL 5.7.1	Page XL 5.7.1	Page XL 5.7.1	Page XL 5.7.1	Page XL 5.7.1	Page XL 5.7.1	Page XL 5.7.2
A..1134 Unit widths: 45/50/60	AG..1134RA Unit widths: 45/50/60	AG..1134LS Unit widths: 45/50/60	AG..1134SE Unit widths: 45/50/60	AG..1134LB Unit widths: 45/50/60	AGS..1134 Unit widths: 45/50/60	AGKS..1134 Unit widths: 45/50/60	A..11552 Unit widths: 45/50/60	ABFL..1155 Unit widths: 60/80/90
Page XL 5.7.2	Page XL 5.7.2	Page XL 5.7.2	Page XL 5.7.2	Page XL 5.7.3	Page XL 5.7.4	Page XL 5.7.4	Page XL 5.7.4	Page XL 5.7.4
ABFL..11551 Unit widths: 60/80/90	ABT..11551 Unit widths: 90	AG..1134D Unit widths: 45/50/60	TAB-AZ..55 Unit widths: 45/50/60/80/90	AJSGG..1136 Unit widths: 60/90	A..11934 Unit widths: 45/50/60	AG..11934RA Unit widths: 45/50/60	AG..11934LS Unit widths: 45/50/60	AG..11934SE Unit widths: 45/50/60
Page XL 5.7.4	Page XL 5.7.4	Page XL 5.7.4	Page XL 5.7.4	Page XL 5.7.5	Page XL 5.7.5	Page XL 5.7.6	Page XL 5.7.6	Page XL 5.7.7
AG..11934LB Unit widths: 45/50/60	AGS..11934 Unit widths: 45/50/60	AGKS..11934 Unit widths: 45/50/60	A..119552 Unit widths: 45/50/60	AG..11934D Unit widths: 45/50/60	TAB-AZ..55 Unit widths: 45/50/60/80/90	AJG..1193677 Unit widths: 50/60/80/90	AJSGG..11936 Unit widths: 60/90	A..12341 Unit widths: 45/50/60
Page XL 5.7.7	Page XL 5.7.7	Page XL 5.7.7	Page XL 5.7.7	Page XL 5.7.7	Page XL 5.7.7	Page XL 5.7.7	Page XL 5.7.8	Page XL 5.7.8
A..1234 Unit widths: 45/50/60	AG..1234RA Unit widths: 45/50/60	AG..1234LS Unit widths: 45/50/60	AG..1234SE Unit widths: 45/50/60	AG..1234LB Unit widths: 45/50/60	AGS..1234 Unit widths: 45/50/60	AGKS..1234 Unit widths: 45/50/60	AGL..1234 Unit widths: 45/50/60	A..12552 Unit widths: 45/50/60
Page XL 5.7.8	Page XL 5.7.8	Page XL 5.7.8	Page XL 5.7.8	Page XL 5.7.9	Page XL 5.7.9	Page XL 5.7.10	Page XL 5.7.10	Page XL 5.7.10
ABFL..1255 Unit widths: 60/80/90	ABFL..12551 Unit widths: 60/80/90	ABT..12551 Unit widths: 90	AG..1234D Unit widths: 45/50/60	AJG..123677 Unit widths: 50/60/80/90	AJSGG..1236 Unit widths: 60/90	A..13234 Unit widths: 45/50/60	AG..13234RA Unit widths: 45/50/60	AG..13234LS Unit widths: 45/50/60
Page XL 5.7.10	Page XL 5.7.10	Page XL 5.7.10	Page XL 5.7.10	Page XL 5.7.10	Page XL 5.7.11	Page XL 5.7.11	Page XL 5.7.12	Page XL 5.7.12
AG..13234SE Unit widths: 45/50/60	AG..13234LB Unit widths: 45/50/60	AGS..13234 Unit widths: 45/50/60	AGKS..13234 Unit widths: 45/50/60	A..132552 Unit widths: 45/50/60	AG..13234D Unit widths: 45/50/60	TAB-AZ..55 Unit widths: 45/50/60/80/90	AJG..1323677 Unit widths: 50/60/80/90	AJSGG..13236 Unit widths: 60/90

# Dresser units

Page XL 5.7.13	Page XL 5.7.13	Page XL 5.7.13	Page XL 5.7.13	Page XL 5.7.13	Page XL 5.7.13	Page XL 5.7.13	Page XL 5.7.13	Page XL 5.7.14
								
A..13341	A..1334	AG..1334RA	AG..1334LS	AG..1334SE	AG..1334LB	AGS..1334	AGKS..1334	AGL..1334
Unit widths: 45/50/60	Unit widths: 45/50/60	Unit widths: 45/50/60	Unit widths: 45/50/60	Unit widths: 45/50/60	Unit widths: 45/50/60	Unit widths: 45/50/60	Unit widths: 45/50/60	Unit widths: 45/50/60
Page XL 5.7.14	Page XL 5.7.14	Page XL 5.7.14	Page XL 5.7.15	Page XL 5.7.15	Page XL 5.7.16	Page XL 5.7.16	Page XL 5.7.16	Page XL 5.7.16
								
A..13552	AG..1334D	TAB-AZ..55	AJG..133677	AJSGG..1336	A..14534	AG..14534RA	AG..14534LS	AG..14534SE
Unit widths: 45/50/60	Unit widths: 45/50/60	Unit widths: 45/50/60/80/90	Unit widths: 50/60/80/90	Unit widths: 60/90	Unit widths: 45/50/60	Unit widths: 45/50/60	Unit widths: 45/50/60	Unit widths: 45/50/60
Page XL 5.7.16	Page XL 5.7.16	Page XL 5.7.16	Page XL 5.7.16	Page XL 5.7.16	Page XL 5.7.17	Page XL 5.7.17	Page XL 5.7.18	Page XL 5.7.18
								
AG..14534LB	AGS..14534	AGKS..14534	A..145552	ABT..14551	AG..14534D	TAB-AZ..55	AJG..1453677	AJSGG..14536
Unit widths: 45/50/60	Unit widths: 45/50/60	Unit widths: 45/50/60	Unit widths: 45/50/60	Unit widths: 90	Unit widths: 45/50/60	Unit widths: 45/50/60/80/90	Unit widths: 50/60/80/90	Unit widths: 60/90
Page XL 5.7.19	Page XL 5.7.19	Page XL 5.7.19	Page XL 5.7.19	Page XL 5.7.19	Page XL 5.7.19			
								
AR..1136	AR..11936	AR..1236	AR..13236	AR..1336	AR..14536			
Unit widths: 30/40/45/50/60	Unit widths: 30/40/45/50/60	Unit widths: 30/40/45/50/60	Unit widths: 30/40/45/50/60	Unit widths: 30/40/45/50/60	Unit widths: 30/40/45/50/60			

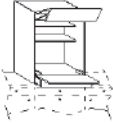

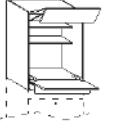


# Dresser units, 113 cm high

□ = Models also available in 45.5/61 cm carcass depth (order no.: replace ... 55 ... with 45/61)

		Order no.		Hinge side: Carcass depth	Price groups										
		W	H		D	1	2	3	4	5	6	7	8	9	
906 126 88		<b>Dresser unit 113 cm high</b>													
		1 door 90.6 cm													
		3 adjustable shelves 1 drawer 12.6 cm 1 fixed panel 8.8 cm													
906 126 88		<b>Dresser unit with glass door 113 cm high</b>													
		-model-specific-													
		1 Framed glass door 90,6 cm 2 adjustable glass shelves 1 drawer 12.6 cm 1 fixed panel 8.8 cm													
		<b>Available for:</b>													
		ARTE-B, ARTE-S, ATLANTA-B, ATLANTA-S, BERGEN, CASA-B, CASTELLO, CHALET-B, CHALET-S, CHICAGO, FRAME, LUGANO, LUX-B, MIAMI, NEW OPAL-M, NOBEL-B, NOBEL-S, OPAL-H, ORLANDO-B, ORLANDO-S, PALAZZO, PALERMO-B, PALERMO-S, ROMA-B, ROMA-S, SIGNUM-B, SOFIE-B, SOFIE-S, VINO, VIVA, YORK-B, YORK-S													
		<b>available glass versions:</b>													
		90 = clear glass 93 = black glass 92 = matt glass 88 = Linea glass													
906 126 88		<b>Dresser unit with glass door 113 cm high</b>													
		-model-specific-													
		1 semi-frameless glass door 90.6 cm 2 adjustable glass shelves 1 drawer 12.6 cm 1 fixed panel 8.8 cm													
		<b>Available for:</b>													
		BAVARIA, EDITION, FENIX INOX, FLORENZ, GARDA, GENT, HPL PRO, MALMÖ, MODENA, MONTANA, MUNICH, NEVADA, OSLO 15, PADUA, PRIMEWOOD TOP, PUR, RESOPAL, RESOPAL PRO, RESOPAL PRO EDGE, RIVA, RUSTY OAK, SHERWOOD, SMART, SMART MIRROR, SMART-M, TESSIN 15, TIM, TIM 15, TOP, TREND, VILLAGE 15-B, VILLAGE 15-S													
		<b>available glass versions:</b>													
		90 = clear glass 93 = black glass 92 = matt glass 88 = Linea glass													
906 126 88		<b>Dresser unit with glass door 113 cm high</b>													
		-model-specific-													
		1 segment glass door 90.6 cm 2 adjustable glass shelves 1 drawer 12.6 cm 1 fixed panel 8.8 cm													
		<b>Available for:</b>													
		EDITION, FENIX INOX, GARDA, HPL PRO, PRIMEWOOD TOP, PUR, RESOPAL, RESOPAL PRO, RESOPAL PRO EDGE, RIVA, SHERWOOD, SMART, SMART MIRROR, SMART-M, TOP, TREND													
		<b>available glass versions:</b>													
		90 = clear glass 93 = black glass 92 = matt glass 88 = Linea glass													
906 126 88		<b>Dresser unit with glass door 113 cm high</b>													
		-model-specific-													
		1 semi-frameless glass door 90.6 cm Glass width 5 cm 2 adjustable glass shelves 1 drawer 12.6 cm 1 fixed panel 8.8 cm													
		<b>Available for:</b>													
		BAVARIA, EDITION, FENIX INOX, FLORENZ, GARDA, HPL PRO, MALMÖ, MODENA, MONTANA, MUNICH, NEVADA, PADUA, PRIMEWOOD TOP, PUR, RESOPAL, RESOPAL PRO, RESOPAL PRO EDGE, RIVA, RUSTY OAK, SHERWOOD, SMART, SMART MIRROR, SMART-M, TOP, TREND													
		<b>available glass versions:</b>													
		90 = clear glass 93 = black glass 92 = matt glass 88 = Linea glass													
906 126 88		<b>Dresser unit with glass door 113 cm high</b>													
		-model-specific-													
		1 glass door 90.6 cm with mullions 2 adjustable glass shelves 1 drawer 12.6 cm 1 fixed panel 8.8 cm													
		<b>Available for:</b>													
		ARTE-B, ARTE-S, CHALET-B, CHALET-S, LUX-B, NOBEL-B, NOBEL-S, PALERMO-B, PALERMO-S, ROMA-B, ROMA-S, SOFIE-B, SOFIE-S, YORK-B, YORK-S													
		<b>available glass versions:</b>													
		90 = clear glass 93 = black glass 92 = matt glass 88 = Linea glass													
		<b>Number of mullions/fields:</b>													
		Width 45 cm: 1 centre bar / 2 fields 13 cm x 13 cm each (W x H)													
		Width 50 cm: 1 centre bar / 2 fields 15.5 cm x 13 cm each (W x H)													
		Width 60 cm: 2 centre bars / 3 fields 13 cm x 13 cm each (W x H)													
906 126 88		<b>Dresser unit with glass door 113 cm high</b>													
		-model-specific-													
		1 glass door 90.6 cm with crossbar 2 adjustable glass shelves 1 drawer 12.6 cm 1 fixed panel 8.8 cm													
		<b>Available for:</b>													
		ARTE-B, ARTE-S, CHALET-B, CHALET-S, LUX-B, NOBEL-B, NOBEL-S, PALERMO-B, PALERMO-S, ROMA-B, ROMA-S, SOFIE-B, SOFIE-S, YORK-B, YORK-S													
		<b>available glass versions:</b>													
		90 = clear glass 93 = black glass 92 = matt glass 88 = Linea glass													
1124		<b>Dresser unit 113 cm high</b>													
		1 door 112.4 cm													
		2 adjustable shelves 1 fixed shelf Without bottom shelf Clear distance to fixed shelf: 52 cm													

## Dresser units, 113 cm high


□ = Models also available in 45.5/61 cm carcass depth (order no.: replace ... 55 ... with 45/61)

	Order no. W H D	Hinge side: Carcass depth	Price groups								
			1	2	3	4	5	6	7	8	9
 <p><b>Dresser bar unit with folding-lifting doors 113 cm as dresser unit on top of worktop</b> 1 folding-lifting door 32.1 cm/32.1 cm 1 adjustable shelf 1 fixed shelf 1 variable bar flap 1 drawer 12.6 cm</p>	<b>ABFL 60 11 55</b>	■	875	934	994	1051	1137	1211	1289	1418	-
	<b>ABFL 80 11 55</b>	■	1058	1243	1293	1361	1537	1620	1729	1902	-
	<b>ABFL 90 11 55</b>	■	1058	1243	1293	1361	1537	1620	1729	1902	-
 <i>For handleless designs, please take the electrification of lifting doors (SET-E HFL, SET-E-A,) in combination with TIP-ON (MP-TIPON60-1) for the drawers. When installing LED lighting, we recommend the contact switch (LED-MTS)</i>											
 <p><b>Dresser bar unit with folding-lifting doors as dresser unit on top of base unit</b> 1 folding-lifting door 32.1 cm/32.1 cm 1 adjustable shelf 1 fixed shelf 1 bar flap 38.6 cm 1 drawer 12.6 cm</p>	<b>ABFL 60 11 55 1</b>	■	875	934	994	1051	1137	1211	1289	1418	-
	<b>ABFL 80 11 55 1</b>	■	1058	1243	1293	1361	1537	1620	1729	1902	-
	<b>ABFL 90 11 55 1</b>	■	1058	1243	1293	1361	1537	1620	1729	1902	-
 <i>For handleless designs, please take the electrification of lifting doors (SET-E HFL, SET-E-A,) in combination with TIP-ON (MP-TIPON60-1) for the drawers. When installing LED lighting, we recommend the contact switch (LED-MTS) Up to a front height of 40 cm, the flap door can be loaded with 20 kg including front weight</i>											
 <p><b>Dresser bar unit with side-hung doors 1168 cm high as dresser unit on top of base unit</b> 2 doors 116.6 cm with wide angle hinges 1 adjustable shelf 1 pull-out shelf</p>	<b>NEW ABT 90 11 55 1</b>	▲	848	888	950	977	1015	1041	1079	1118	-

## Dresser units, 113 cm high with glass fronts



Carcass thickness 16 mm

906  
126  
88

	Order no. W H D	Hinge side: Carcass depth	Glass groups									
			1	2	3	4	5	6	7	8	9	
 <p><b>Dresser unit with glass front 113 cm high</b> -neutral- 1 glass door 90.6 cm <b>G2/G2S</b> 2 adjustable glass shelves 1 drawer 12.6 cm, model-specific 1 fixed panel 8.8 cm, model-specific</p>	<b>AG 45 11 34 D</b>	R/L	847	847	847	847	847	847	847	932	-	
	<i>extra charges for G5S</i>			130	130	130	130	130	130	130	130	
	<b>AG 50 11 34 D</b>	R/L	854	854	854	854	854	854	854	854	939	-
	<i>extra charges for G5S</i>			122	122	122	122	122	122	122	122	122
	<b>AG 60 11 34 D</b>	R/L	923	923	923	923	923	923	923	923	1015	-
<i>extra charges for G5S</i>			139	139	139	139	139	139	139	139	139	
<b>G 1</b>	<b>G 2</b>	<b>G 2S</b>										
<b>G1 AKTIV</b> glass frame 991 Matt glass 992 Translucent black glass	<b>G2 Design front</b> 925 Frame White Agate/Matt glass 935 Premium W. Frame/Matt Glass 940 Macaron Col. Frame/Matt Glass 95 Light grey frame/matt glass 96 Silver Col. Frame/Matt Glass 960 Snow White Frame/Matt Glass 97 Black frame/black glass	<b>G2S aluminium, framed glass door</b> 988 aluminium black, Linea glass 994 Aluminium frame/clear glass 995 aluminium frame/black glass										
<b>G 5</b>	<b>G 5S</b>	<b>G 6</b>										
	G5S aluminium, door with mullion 996 Alum.frame/clear gl./cross bar	<b>G6 NEW SALON</b> 986 aluminium black, black glass 987 aluminium black, clear glass 989 aluminium matt, bronze-coloured black glass 990 aluminium matt, bronze-coloured clear glass										

## Additional equipment

□ = Models also available in 45.5/61 cm carcass depth (order no.: replace ... 55 ... with 45/61)

	Order no. W H D	Hinge side: Carcass depth	Decor groups									
			M10	M20	M30	M40	M50	M60	M70	M80	M90	
 <p><b>Pull-out shelf with guide rails</b> With locking function, full pull-out „push to open“, shelf from decor group K For carcass width 45 cm, 50 cm, 60 cm For carcass width 80 cm, 90 cm for carcass depths 45.5 cm and 55.5 cm</p> <p>Load-bearing capacity depth 55.5 cm: 35 kg Load-bearing capacity depth 45.5 cm: 35 kg Load-bearing capacity depth 55.5 cm: 35 kg Load-bearing capacity depth 45.5 cm: 35 kg Load-bearing capacity depth 55.5 cm: 35 kg Load-bearing capacity depth 45.5 cm: 35 kg Load-bearing capacity depth 55.5 cm: 30 kg Load-bearing capacity depth 45.5 cm: 30 kg Load-bearing capacity depth 55.5 cm: 30 kg Load-bearing capacity depth 45.5 cm: 30 kg</p>			 <b>Important:</b> <i>When installing in units with hinged doors always take wide angle hinges SA-90155E3 into consideration.</i>									
	<b>TAB-AZ45 55</b>			220	-	-	-	-	-	-	-	-
	<b>TAB-AZ45 45</b>			220	-	-	-	-	-	-	-	-
	<b>TAB-AZ50 55</b>			225	-	-	-	-	-	-	-	-
	<b>TAB-AZ50 45</b>			225	-	-	-	-	-	-	-	-
	<b>TAB-AZ60 55</b>			234	-	-	-	-	-	-	-	-
	<b>TAB-AZ60 45</b>			234	-	-	-	-	-	-	-	-
	<b>TAB-AZ80 55</b>			282	-	-	-	-	-	-	-	-
	<b>TAB-AZ80 45</b>			282	-	-	-	-	-	-	-	-
	<b>TAB-AZ90 55</b>			298	-	-	-	-	-	-	-	-
	<b>TAB-AZ90 45</b>			298	-	-	-	-	-	-	-	-

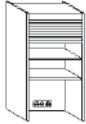



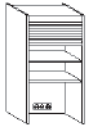



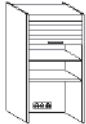


# Dresser units, 113 cm high with roller shutter

Carcase thickness 16 mm

The useable inside depth (bare dimension) for the following carcass depths is  
 36.1 cm – bare dimension 26.5 cm / 47.7 cm – bare dimension 38.1 cm  
 57.7 cm – bare dimension 48.1 cm / 63.2 cm – bare dimension 53.6 cm  
 ▲ = Types also available with 63.2 cm carcass depth (order no. ... replace ... 58 ... with 63)

Order no.  
W H D

Hinge side:	Carcass depth	Decor groups								
		M10	M20	M30	M40	M50	M60	M70	M80	M90










 <p><b>Dresser unit with roller shutter</b>  <b>113 cm high 36,1 cm deep</b>                      Roller shutter stainless steel decor                      2 adjustable shelves                      1 fixed shelf 52 cm from below                      3 sockets</p>		<b>AJG 50 11 36 77</b>			1009	-	-	-	1920	-	2186	-	-
		<b>AJG 60 11 36 77</b>			1065	-	-	-	2049	-	2339	-	-
		<b>AJG 80 11 36 77</b>			1182	-	-	-	2311	-	2650	-	-
		<b>AJG 90 11 36 77</b>			1248	-	-	-	2450	-	2813	-	-
						 No visible sides possible in other decor groups							
<p>as above, but  <b>Dresser unit with roller shutter</b>  <b>113 cm high 47,7 cm deep</b></p>		<b>AJG 50 11 48 77</b>			1041	-	-	-	2099	-	2422	-	-
		<b>AJG 60 11 48 77</b>			1098	-	-	-	2245	-	2599	-	-
		<b>AJG 80 11 48 77</b>			1219	-	-	-	2543	-	2955	-	-
		<b>AJG 90 11 48 77</b>			1286	-	-	-	2698	-	3142	-	-
						 No visible sides possible in other decor groups							
<p>as above, but  <b>Dresser unit with roller shutter</b>  <b>113 cm high</b></p>		<b>AJG 50 11 58 77</b>		▲	1067	-	-	-	2254	-	2627	-	-
		<b>AJG 60 11 58 77</b>		▲	1128	-	-	-	2415	-	2823	-	-
		<b>AJG 80 11 58 77</b>		▲	1251	-	-	-	2742	-	3219	-	-
		<b>AJG 90 11 58 77</b>		▲	1320	-	-	-	2913	-	3425	-	-
						 optional accessory: only TAB-A**45 can be used as a pull-out shelf, and only 577 mm deep No visible sides possible in other decor groups							
 <p><b>Dresser unit with roller shutter</b>  <b>113 cm high 36,1 cm deep</b>                      Roller shutters black laminate                      2 adjustable shelves                      1 fixed shelf 52 cm from below                      3 sockets</p>		<b>AJG 50 11 36 78</b>			1073	-	-	-	1983	-	2249	-	-
		<b>AJG 60 11 36 78</b>			1132	-	-	-	2116	-	2406	-	-
		<b>AJG 80 11 36 78</b>			1256	-	-	-	2385	-	2724	-	-
		<b>AJG 90 11 36 78</b>			1326	-	-	-	2528	-	2892	-	-
						 No visible sides possible in other decor groups							
<p>as above, but  <b>Dresser unit with roller shutter</b>  <b>113 cm high 47,7 cm deep</b></p>		<b>AJG 50 11 48 78</b>			1105	-	-	-	2162	-	2486	-	-
		<b>AJG 60 11 48 78</b>			1165	-	-	-	2312	-	2666	-	-
		<b>AJG 80 11 48 78</b>			1293	-	-	-	2617	-	3031	-	-
		<b>AJG 90 11 48 78</b>			1365	-	-	-	2777	-	3220	-	-
						 No visible sides possible in other decor groups							
<p>as above, but  <b>Dresser unit with roller shutter</b>  <b>113 cm high</b></p>		<b>AJG 50 11 58 78</b>		▲	1131	-	-	-	2317	-	2690	-	-
		<b>AJG 60 11 58 78</b>		▲	1194	-	-	-	2481	-	2890	-	-
		<b>AJG 80 11 58 78</b>		▲	1325	-	-	-	2816	-	3293	-	-
		<b>AJG 90 11 58 78</b>		▲	1399	-	-	-	2991	-	3503	-	-
						 optional accessory: only TAB-A**45 can be used as a pull-out shelf, and only 577 mm deep No visible sides possible in other decor groups							
 <p><b>Dresser unit</b>  <b>SMARTGLAS roller shutters</b>  <b>113 cm high 36,1 cm deep</b>                      2 adjustable shelves                      1 fixed shelf 52 cm from below                      3 sockets</p>		<b>AJSGG 60 11 36</b>			2033	-	-	-	3017	-	3307	-	-
		<b>AJSGG 90 11 36</b>			2268	-	-	-	3470	-	3834	-	-
					 Panel, guide profile and handle in the same colour as the roller shutter No visible sides possible in other decor groups								
<p>as above, but  <b>Dresser unit</b>  <b>SMARTGLAS roller shutters</b>  <b>113 cm high 47,7 cm deep</b></p>		<b>AJSGG 60 11 48</b>			2067	-	-	-	3214	-	3567	-	-
		<b>AJSGG 90 11 48</b>			2307	-	-	-	3720	-	4163	-	-
<p>as above, but  <b>Dresser unit</b>  <b>SMARTGLAS roller shutters</b>  <b>113 cm high</b></p>		<b>AJSGG 60 11 58</b>		▲	2096	-	-	-	3384	-	3791	-	-
		<b>AJSGG 90 11 58</b>		▲	2340	-	-	-	3934	-	4446	-	-
					 optional accessory: only TAB-A**45 can be used as a pull-out shelf, and only 577 mm deep No visible sides possible in other decor groups								

M 10	M 20	M 30	M 40	M 50
K M10 laminate				B M50 Velvet Lacquer S Microstructure lacquer
M 60	M 70	M 80	M 90	
	F M70 veneer / oak / walnut Z M70 Veneer / Bavaria			





# Dresser units, 119.5 cm high

□ = Models also available in 45.5/61 cm carcass depth (order no.: replace ... 55 ... with 45/61)

	Order no.	W	H	D	Hinge side:	Carcass depth	Price groups								
							1	2	3	4	5	6	7	8	9
 <p><b>Dresser unit 119.5 cm high</b> 1 door 90.6 cm 3 adjustable shelves 1 drawer 12.6 cm 1 drawer 14.9 cm</p>		<b>A 45 119 34</b>	R/L	639	652	667	807	850	869	933	1026	-			
		<b>A 50 119 34</b>	R/L	639	652	667	807	850	869	933	1026	-			
		<b>A 60 119 34</b>	R/L	677	691	707	869	912	931	993	1092	-			
 <p><b>Dresser unit with glass door 119.5 cm high</b> -model-specific- 1 Framed glass door 90,6 cm 2 adjustable glass shelves 1 drawer 12.6 cm 1 drawer 14.9 cm</p>		<b>AG 45 119 34 RA</b>	R/L	814	814	824	962	962	982	1039	1143	-			
		<b>AG 50 119 34 RA</b>	R/L	814	814	824	962	962	982	1039	1143	-			
		<b>AG 60 119 34 RA</b>	R/L	875	875	885	1035	1035	1055	1115	1227	-			
		<p><b>Available for:</b> ARTE-B, ARTE-S, ATLANTA-B, ATLANTA-S, BERGEN, CASA-B, CASTELLO, CHALET-B, CHALET-S, CHICAGO, FRAME, LUGANO, LUX-B, MIAMI, NEW OPAL-M, NOBEL-B, NOBEL-S, OPAL-H, ORLANDO-B, ORLANDO-S, PALAZZO, PALERMO-B, PALERMO-S, ROMA-B, ROMA-S, SIGNUM-B, SOFIE-B, SOFIE-S, VINO, VIVA, YORK-B, YORK-S</p> <p><b>available glass versions:</b> 90 = clear glass 93 = black glass 92 = matt glass 88 = Linea glass</p>													
 <p><b>Dresser unit with glass door 119.5 cm high</b> -model-specific- 1 semi-frameless glass door 90.6 cm 2 adjustable glass shelves 1 drawer 12.6 cm 1 drawer 14.9 cm</p>		<b>AG 45 119 34 LS</b>	R/L	814	814	824	962	962	982	1039	1143	-			
		<b>AG 50 119 34 LS</b>	R/L	814	814	824	962	962	982	1039	1143	-			
		<b>AG 60 119 34 LS</b>	R/L	875	875	885	1035	1035	1055	1115	1227	-			
		<p><b>Available for:</b> BAVARIA, EDITION, FENIX INOX, FLORENZ, GARDA, GENT, HPL PRO, MALMÖ, MODENA, MONTANA, MUNICH, NEVADA, OSLO 15, PADUA, PRIMEWOOD TOP, PUR, RESOPAL, RESOPAL PRO, RESOPAL PRO EDGE, RIVA, RUSTY OAK, SHERWOOD, SMART, SMART MIRROR, SMART-M, TESSIN 15, TIM, TIM 15, TOP, TREND, VILLAGE 15-B, VILLAGE 15-S</p> <p><b>available glass versions:</b> 90 = clear glass 93 = black glass 92 = matt glass 88 = Linea glass</p>													
 <p><b>Dresser unit with glass door 119.5 cm high</b> -model-specific- 1 segment glass door 90.6 cm 2 adjustable glass shelves 1 drawer 12.6 cm 1 drawer 14.9 cm</p>		<b>AG 45 119 34 SE</b>	R/L	846	846	855	990	990	1013	1070	1177	-			
		<b>AG 50 119 34 SE</b>	R/L	846	846	855	990	990	1013	1070	1177	-			
		<b>AG 60 119 34 SE</b>	R/L	907	907	917	1065	1065	1085	1147	1262	-			
		<p><b>Available for:</b> EDITION, FENIX INOX, GARDA, HPL PRO, PRIMEWOOD TOP, PUR, RESOPAL, RESOPAL PRO, RESOPAL PRO EDGE, RIVA, SHERWOOD, SMART, SMART MIRROR, SMART-M, TOP, TREND</p> <p><b>available glass versions:</b> 90 = clear glass 93 = black glass 92 = matt glass 88 = Linea glass</p>													
 <p><b>Dresser unit with glass door 119.5 cm high</b> -model-specific- 1 semi-frameless glass door 90.6 cm Glass width 5 cm 2 adjustable glass shelves 1 drawer 12.6 cm 1 drawer 14.9 cm</p>		<b>AG 45 119 34 LB</b>	R/L	846	846	855	990	990	1013	1070	1177	-			
		<b>AG 50 119 34 LB</b>	R/L	846	846	855	990	990	1013	1070	1177	-			
		<b>AG 60 119 34 LB</b>	R/L	907	907	917	1065	1065	1085	1147	1262	-			
		<p><b>Available for:</b> BAVARIA, EDITION, FENIX INOX, FLORENZ, GARDA, HPL PRO, MALMÖ, MODENA, MONTANA, MUNICH, NEVADA, PADUA, PRIMEWOOD TOP, PUR, RESOPAL, RESOPAL PRO, RESOPAL PRO EDGE, RIVA, RUSTY OAK, SHERWOOD, SMART, SMART MIRROR, SMART-M, TOP, TREND</p> <p><b>available glass versions:</b> 90 = clear glass 93 = black glass 92 = matt glass 88 = Linea glass</p>													
 <p><b>Dresser unit with glass door 119.5 cm high</b> -model-specific- 1 glass door 90.6 cm with mullions 2 adjustable glass shelves 1 drawer 12.6 cm 1 drawer 14.9 cm</p>		<b>AGS 45 119 34</b>	R/L	-	-	1131	1259	1259	-	-	-	-			
		<b>AGS 50 119 34</b>	R/L	-	-	1131	1259	1259	-	-	-	-			
		<b>AGS 60 119 34</b>	R/L	-	-	1193	1336	1336	-	-	-	-			
		<p><b>Available for:</b> ARTE-B, ARTE-S, CHALET-B, CHALET-S, LUX-B, NOBEL-B, NOBEL-S, PALERMO-B, PALERMO-S, ROMA-B, ROMA-S, SOFIE-B, SOFIE-S, YORK-B, YORK-S</p> <p><b>available glass versions:</b> 90 = clear glass 93 = black glass 92 = matt glass 88 = Linea glass</p> <p><b>Number of mullions/fields:</b> Width 45 cm: 1 centre bar / 2 fields 13 cm x 13 cm each (W x H) Width 50 cm: 1 centre bar / 2 fields 15.5 cm x 13 cm each (W x H) Width 60 cm: 2 centre bars / 3 fields 13 cm x 13 cm each (W x H)</p>													
 <p><b>Dresser unit with glass door 119.5 cm high</b> -model-specific- 1 glass door 90.6 cm with crossbar 2 adjustable glass shelves 1 drawer 12.6 cm 1 drawer 14.9 cm</p>		<b>AGKS 45 119 34</b>	R/L	-	-	1131	1259	1259	-	-	-	-			
		<b>AGKS 50 119 34</b>	R/L	-	-	1131	1259	1259	-	-	-	-			
		<b>AGKS 60 119 34</b>	R/L	-	-	1193	1336	1336	-	-	-	-			
		<p><b>Available for:</b> ARTE-B, ARTE-S, CHALET-B, CHALET-S, LUX-B, NOBEL-B, NOBEL-S, PALERMO-B, PALERMO-S, ROMA-B, ROMA-S, SOFIE-B, SOFIE-S, YORK-B, YORK-S</p> <p><b>available glass versions:</b> 90 = clear glass 93 = black glass 92 = matt glass 88 = Linea glass</p>													
 <p><b>Dresser unit 119.5 cm high</b> 1 door 118.9 cm 2 adjustable shelves 1 fixed shelf Without bottom shelf Clear distance to fixed shelf: 52 cm</p>		<b>A 45 119 55 2</b>	R/L	□	364	379	436	619	651	684	755	830	-		
		<b>A 50 119 55 2</b>	R/L	□	364	379	436	619	651	684	755	830	-		
		<b>A 60 119 55 2</b>	R/L	□	376	390	449	630	686	719	791	869	-		


# Dresser units, 119.5 cm high with glass fronts

Carcase thickness 16 mm

		Order no.		Hinge side:	Carcase depth	Price groups										
		W	H			D	1	2	3	4	5	6	7	8	9	
906 126 149	 <p><b>Dresser unit with glass front</b> <b>119.5 cm high</b> -neutral- 1 glass door 90.6 cm <b>G2/G2S</b> 2 adjustable glass shelves 1 drawer 12.6 cm, model-specific 1 drawer 14.9 cm, model-specific</p>		<b>AG 45 119 34D</b>		R/L	1028	1028	1028	1028	1028	1028	1028	1131	-		
			extra charges for G5S		R/L	140	140	140	140	140	140	140	140	140	-	
			<b>AG 50 119 34D</b>		R/L	1037	1037	1037	1037	1037	1037	1037	1037	1037	1141	-
			extra charges for G5S		R/L	133	133	133	133	133	133	133	133	133	133	-
			<b>AG 60 119 34D</b>		R/L	1107	1107	1107	1107	1107	1107	1107	1218	-		
			extra charges for G5S			152	152	152	152	152	152	152	152	-		
<b>G 1</b>		<b>G 2</b>		<b>G 2S</b>												
<b>G1 AKTIVglass frame</b> 991 Matt glass 992 Translucent black glass		<b>G2 Design front</b> 925 Frame White Agate/Matt glass 935 Premium W. Frame/Matt Glass 940 Macaron Col. Frame/Matt Glass 95 Light grey frame/matt glass 96 Silver Col. Frame/Matt Glass 960 Snow White Frame/Matt Glass 97 Black frame/black glass		<b>G2S aluminium, framed glass door</b> 988 aluminium black, Linea glass 994 Aluminium frame/clear glass 995 aluminium frame/black glass												
<b>G 5</b>		<b>G 5S</b>		<b>G 6</b>												
		G5S aluminium, door with mullion 996 Alum.frame/clear gl./cross bar		<b>G6 NEW SALON</b> 986 aluminium black, black glass 987 aluminium black, clear glass 989 aluminium matt, bronze-coloured black glass 990 aluminium matt, bronze-coloured clear glass												

## Additional equipment

□ = Models also available in 45.5/61 cm carcase depth (order no.: replace ... 55 ... with 45/61)

		Order no.		Hinge side:	Carcase depth	Decor groups									
		W	H			D	M10	M20	M30	M40	M50	M60	M70	M80	M90
 <p><b>Pull-out shelf with guide rails</b> With locking function, full pull-out „push to open“, shelf from decor group K For carcase width 45 cm, 50 cm, 60 cm For carcase width 80 cm, 90 cm for carcase depths 45.5 cm and 55.5 cm</p> <p>Load-bearing capacity depth 55.5 cm: 35 kg Load-bearing capacity depth 45.5 cm: 35 kg Load-bearing capacity depth 55.5 cm: 35 kg Load-bearing capacity depth 45.5 cm: 35 kg Load-bearing capacity depth 55.5 cm: 35 kg Load-bearing capacity depth 45.5 cm: 35 kg Load-bearing capacity depth 55.5 cm: 30 kg Load-bearing capacity depth 45.5 cm: 30 kg Load-bearing capacity depth 55.5 cm: 30 kg Load-bearing capacity depth 45.5 cm: 30 kg</p>					<p><b>Important:</b> When installing in units with hinged doors always take wide angle hinges SA-90155E3 into consideration.</p>										
			<b>TAB-AZ45 55</b>			220	-	-	-	-	-	-	-	-	-
			<b>TAB-AZ45 45</b>			220	-	-	-	-	-	-	-	-	-
			<b>TAB-AZ50 55</b>			225	-	-	-	-	-	-	-	-	-
			<b>TAB-AZ50 45</b>			225	-	-	-	-	-	-	-	-	-
			<b>TAB-AZ60 55</b>			234	-	-	-	-	-	-	-	-	-
			<b>TAB-AZ60 45</b>			234	-	-	-	-	-	-	-	-	-
			<b>TAB-AZ80 55</b>			282	-	-	-	-	-	-	-	-	-
			<b>TAB-AZ80 45</b>			282	-	-	-	-	-	-	-	-	-
			<b>TAB-AZ90 55</b>			298	-	-	-	-	-	-	-	-	-
			<b>TAB-AZ90 45</b>			298	-	-	-	-	-	-	-	-	-

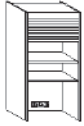
# Dresser units, 119.5 cm high with roller shutter

Carcase thickness 16 mm

The useable inside depth (bare dimension) for the following carcass depths is  
 36.1 cm – bare dimension 26.5 cm / 47.7 cm – bare dimension 38.1 cm  
 57.7 cm – bare dimension 48.1 cm / 63.2 cm – bare dimension 53.6 cm  
 ▲ = Types also available with 63.2 cm carcass depth (order no. ... replace ... 58 ... with 63)

Order no.  
W H D

Hinge side:	Carcass depth	Decor groups								
		M10	M20	M30	M40	M50	M60	M70	M80	M90



**Dresser unit with roller shutter**  
**119.5 cm high 36,1 cm deep**  
 Roller shutter stainless steel decor  
 2 adjustable shelves  
 1 fixed shelf 52 cm from below  
 3 sockets

AJG	50	119	36	77	1021	-	-	-	1955	-	2228	-	-
AJG	60	119	36	77	1078	-	-	-	2085	-	2384	-	-
AJG	80	119	36	77	1195	-	-	-	2351	-	2699	-	-
AJG	90	119	36	77	1260	-	-	-	2492	-	2864	-	-

No visible sides possible in other decor groups

as above, but  
**Dresser unit with roller shutter**  
**119.5 cm high 47,7 cm deep**

AJG	50	119	48	77	1053	-	-	-	2138	-	2471	-	-
AJG	60	119	48	77	1112	-	-	-	2286	-	2649	-	-
AJG	80	119	48	77	1232	-	-	-	2587	-	3010	-	-
AJG	90	119	48	77	1300	-	-	-	2745	-	3198	-	-

No visible sides possible in other decor groups

as above, but  
**Dresser unit with roller shutter**  
**119.5 cm high**

AJG	50	119	58	77	▲ 1081	-	-	-	2297	-	2680	-	-
AJG	60	119	58	77	▲ 1141	-	-	-	2460	-	2878	-	-
AJG	80	119	58	77	▲ 1265	-	-	-	2791	-	3279	-	-
AJG	90	119	58	77	▲ 1333	-	-	-	2964	-	3486	-	-

optional accessory:  
 only TAB-A\*\*45 can be used as a pull-out shelf, and only 577 mm deep  
 No visible sides possible in other decor groups



**Dresser unit with roller shutter**  
**119.5 cm high 36,1 cm deep**  
 Roller shutters black laminate  
 2 adjustable shelves  
 1 fixed shelf 52 cm from below  
 3 sockets

AJG	50	119	36	78	1084	-	-	-	2018	-	2292	-	-
AJG	60	119	36	78	1144	-	-	-	2152	-	2450	-	-
AJG	80	119	36	78	1269	-	-	-	2426	-	2773	-	-
AJG	90	119	36	78	1340	-	-	-	2571	-	2943	-	-

No visible sides possible in other decor groups

as above, but  
**Dresser unit with roller shutter**  
**119.5 cm high 47,7 cm deep**

AJG	50	119	48	78	1116	-	-	-	2202	-	2534	-	-
AJG	60	119	48	78	1178	-	-	-	2353	-	2716	-	-
AJG	80	119	48	78	1306	-	-	-	2662	-	3085	-	-
AJG	90	119	48	78	1379	-	-	-	2824	-	3278	-	-

No visible sides possible in other decor groups

as above, but  
**Dresser unit with roller shutter**  
**119.5 cm high**

AJG	50	119	58	78	▲ 1145	-	-	-	2361	-	2743	-	-
AJG	60	119	58	78	▲ 1207	-	-	-	2527	-	2945	-	-
AJG	80	119	58	78	▲ 1339	-	-	-	2865	-	3354	-	-
AJG	90	119	58	78	▲ 1413	-	-	-	3042	-	3566	-	-

optional accessory:  
 only TAB-A\*\*45 can be used as a pull-out shelf, and only 577 mm deep  
 No visible sides possible in other decor groups



**Dresser unit**  
**SMARTGLAS roller shutters**  
**119.5 cm high 36,1 cm deep**  
 2 adjustable shelves  
 1 fixed shelf 52 cm from below  
 3 sockets

AJSGG	60	119	36	2046	-	-	-	3053	-	3352	-	-
AJSGG	90	119	36	2281	-	-	-	3513	-	3885	-	-

Panel, guide profile and handle in the same colour as the roller shutter  
 No visible sides possible in other decor groups

as above, but  
**Dresser unit**  
**SMARTGLAS roller shutters**  
**119.5 cm high 47,7 cm deep**

AJSGG	60	119	48	2080	-	-	-	3254	-	3617	-	-
AJSGG	90	119	48	2320	-	-	-	3766	-	4219	-	-

as above, but  
**Dresser unit**  
**SMARTGLAS roller shutters**  
**119.5 cm high**

AJSGG	60	119	58	▲ 2108	-	-	-	3428	-	3846	-	-
AJSGG	90	119	58	▲ 2354	-	-	-	3985	-	4507	-	-


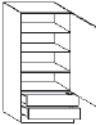






optional accessory:  
 only TAB-A\*\*45 can be used as a pull-out shelf, and only 577 mm deep  
 No visible sides possible in other decor groups

M 10	M 20	M 30	M 40	M 50
K M10 laminate				B M50 Velvet Lacquer S Microstructur lacquer
M 60	M 70	M 80	M 90	
	F M70 veneer / oak / walnut Z M70 Veneer / Bavaria			

# Dresser units, 126 cm high

Carcase depth 34 cm




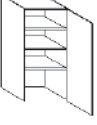
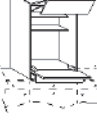




□ = Models also available in 45.5/61 cm carcass depth (order no.: replace ... 55 ... with 45/61)

Order no.	W	H	D	Hinge side:	Carcass depth	Price groups															
						1	2	3	4	5	6	7	8	9							
1166 88 	<b>Dresser unit 126 cm high</b>																				
	1 door 116.6 cm																				
	3 adjustable shelves																				
1 fixed panel 8.8 cm																					
906 126 88 	<b>Dresser unit 126 cm high</b>																				
	1 door 90.6 cm																				
	3 adjustable shelves																				
2 drawers 12.6 cm																					
1 fixed panel 8.8 cm																					
906 126 88 	<b>Dresser unit with glass door</b>																				
	126 cm high																				
	-model-specific-																				
1 Framed glass door 90,6 cm																					
2 adjustable glass shelves																					
2 drawers 12.6 cm																					
1 fixed panel 8.8 cm																					
Available for: ARTE-B, ARTE-S, ATLANTA-B, ATLANTA-S, BERGEN, CASA-B, CASTELLO, CHALET-B, CHALET-S, CHICAGO, FRAME, LUGANO, LUX-B, MIAMI, NEW OPAL-M, NOBEL-B, NOBEL-S, OPAL-H, ORLANDO-B, ORLANDO-S, PALAZZO, PALERMO-B, PALERMO-S, ROMA-B, ROMA-S, SIGNUM-B, SOFIE-B, SOFIE-S, VINO, VIVA, YORK-B, YORK-S																					
available glass versions: 90 = clear glass 93 = black glass 92 = matt glass 88 = Linea glass																					
906 126 88 	<b>Dresser unit with glass door</b>																				
	126 cm high																				
	-model-specific-																				
1 semi-frameless glass door 90.6 cm																					
2 adjustable glass shelves																					
2 drawers 12.6 cm																					
1 fixed panel 8.8 cm																					
Available for: BAVARIA, EDITION, FENIX INOX, FLORENZ, GARDA, GENT, HPL PRO, MALMÖ, MODENA, MONTANA, MUNICH, NEVADA, OSLO 15, PADUA, PRIMEWOOD TOP, PUR, RESOPAL, RESOPAL PRO, RESOPAL PRO EDGE, RIVA, RUSTY OAK, SHERWOOD, SMART, SMART MIRROR, SMART-M, TESSIN 15, TIM, TIM 15, TOP, TREND, VILLAGE 15-B, VILLAGE 15-S																					
available glass versions: 90 = clear glass 93 = black glass 92 = matt glass 88 = Linea glass																					
906 126 88 	<b>Dresser unit with glass door</b>																				
	126 cm high																				
	-model-specific-																				
1 segment glass door 90.6 cm																					
2 adjustable glass shelves																					
2 drawers 12.6 cm																					
1 fixed panel 8.8 cm																					
Available for: EDITION, FENIX INOX, GARDA, HPL PRO, PRIMEWOOD TOP, PUR, RESOPAL, RESOPAL PRO, RESOPAL PRO EDGE, RIVA, SHERWOOD, SMART, SMART MIRROR, SMART-M, TOP, TREND																					
available glass versions: 90 = clear glass 93 = black glass 92 = matt glass 88 = Linea glass																					
906 126 88 	<b>Dresser unit with glass door</b>																				
	126 cm high																				
	-model-specific-																				
1 semi-frameless glass door 90.6 cm																					
Glass width 5 cm																					
2 adjustable glass shelves																					
2 drawers 12.6 cm																					
1 fixed panel 8.8 cm																					
Available for: BAVARIA, EDITION, FENIX INOX, FLORENZ, GARDA, HPL PRO, MALMÖ, MODENA, MONTANA, MUNICH, NEVADA, PADUA, PRIMEWOOD TOP, PUR, RESOPAL, RESOPAL PRO, RESOPAL PRO EDGE, RIVA, RUSTY OAK, SHERWOOD, SMART, SMART MIRROR, SMART-M, TOP, TREND																					
available glass versions: 90 = clear glass 93 = black glass 92 = matt glass 88 = Linea glass																					
906 126 88 	<b>Dresser unit with glass door</b>																				
	126 cm high																				
	-model-specific-																				
1 glass door 90.6 cm with mullions																					
2 adjustable glass shelves																					
2 drawers 12.6 cm																					
1 fixed panel 8.8 cm																					
Available for: ARTE-B, ARTE-S, CHALET-B, CHALET-S, LUX-B, NOBEL-B, NOBEL-S, PALERMO-B, PALERMO-S, ROMA-B, ROMA-S, SOFIE-B, SOFIE-S, YORK-B, YORK-S																					
available glass versions: 90 = clear glass 93 = black glass 92 = matt glass 88 = Linea glass																					
Number of mullions/fields: width 45 cm: 1 centre bar / 2 fields 13 cm x 13 cm each (W x H) width 50 cm: 1 centre bar / 2 fields 15.5 cm x 13 cm each (W x H) width 60 cm: 2 centre bars / 3 fields 13 cm x 13 cm each (W x H)																					
906 126 88 	<b>Dresser unit with glass door</b>																				
	126 cm high																				
	-model-specific-																				
1 glass door 90.6 cm with crossbar																					
2 adjustable glass shelves																					
2 drawers 12.6 cm																					
1 fixed panel 8.8 cm																					
Available for: ARTE-B, ARTE-S, CHALET-B, CHALET-S, LUX-B, NOBEL-B, NOBEL-S, PALERMO-B, PALERMO-S, ROMA-B, ROMA-S, SOFIE-B, SOFIE-S, YORK-B, YORK-S																					
available glass versions: 90 = clear glass 93 = black glass 92 = matt glass 88 = Linea glass																					

# Dresser units, 126 cm high

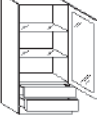

Carcase depth 34 cm

□ = Models also available in 45.5/61 cm carcass depth (order no.: replace ... 55 ... with 45/61)

		Order no.		Hinge side:	Carcass depth	Price groups								
		W	H			D	1	2	3	4	5	6	7	8
 <p><b>Dresser unit with glass door</b> 126 cm high 1 glass door 125.4 cm 2 adjustable glass shelves 1 fixed shelf Without bottom shelf</p>		<b>AGL 45 12 34</b>		R/L		823	823	828	948	948	967	1024	1126	-
		<b>AGL 50 12 34</b>		R/L		823	823	828	948	948	967	1024	1126	-
		<b>AGL 60 12 34</b>		R/L		876	876	885	1034	1034	1052	1111	1222	-
	<p><b>Available for:</b>   ARTE-B, ARTE-S, CHALET-B, CHALET-S, LUX-B, NOBEL-B, NOBEL-S, PALERMO-B, PALERMO-S, ROMA-B, ROMA-S, SOFIE-B, SOFIE-S, YORK-B, YORK-S</p> <p><b>available glass versions:</b>   90 = clear glass 93 = black glass 92 = matt glass 88 = Linea glass</p>													
 <p><b>Dresser unit 126 cm high</b> 1 door 125.4 cm 2 adjustable shelves 1 fixed shelf Without bottom shelf Clear distance to fixed shelf: 52 cm</p>		<b>A 45 12 55 2</b>		R/L	□	411	426	485	663	696	730	800	879	-
		<b>A 50 12 55 2</b>		R/L	□	411	426	485	663	696	730	800	879	-
		<b>A 60 12 55 2</b>		R/L	□	422	436	496	675	731	767	837	920	-
 <p><b>Dresser bar unit with folding-lifting doors</b> 126 cm as dresser unit on top of worktop 1 folding-lifting door 38.6 cm/38.6 cm 2 adjustable shelves 1 fixed shelf 1 variable bar flap 1 drawer 12.6 cm</p>		<b>ABFL 60 12 55</b>			■	887	945	1006	1057	1142	1217	1293	1422	-
		<b>ABFL 80 12 55</b>			■	1072	1255	1303	1372	1549	1631	1741	1915	-
		<b>ABFL 90 12 55</b>			■	1072	1255	1303	1372	1549	1631	1741	1915	-
<p> For handleless designs, please take the electrification of lifting doors (SET-E HFL, SET-E-A) in combination with TIP-ON (MP-TIPON60-1) for the drawers. When installing LED lighting, we recommend the contact switch (LED-MTS)</p>														
 <p><b>Dresser bar unit with folding-lifting doors as dresser unit on top of base unit</b> 1 folding-lifting door 38.6 cm/38.6 cm 2 adjustable shelves 1 fixed shelf 1 bar flap 38.6 cm 1 drawer 12.6 cm</p>		<b>ABFL 60 12 551</b>			■	887	945	1006	1057	1142	1217	1293	1422	-
		<b>ABFL 80 12 55 1</b>			■	1072	1255	1303	1372	1549	1631	1741	1915	-
		<b>ABFL 90 12 55 1</b>			■	1072	1255	1303	1372	1549	1631	1741	1915	-
<p> For handleless designs, please take the electrification of lifting doors (SET-E HFL, SET-E-A) in combination with TIP-ON (MP-TIPON60-1) for the drawers. When installing LED lighting, we recommend the contact switch (LED-MTS) Up to a front height of 40 cm, the flap door can be loaded with 20 kg including front weight</p>														
 <p><b>Dresser bar unit with side-hung doors 1298 cm high as dresser unit on top of base unit</b> 2 doors 129.6 cm with wide angle hinges 2 adjustable shelves 1 pull-out shelf</p>	<b>NEW</b>	<b>ABT 90 12 55 1</b>			▲	871	915	985	1012	1052	1079	1117	1160	-

## Dresser units, 126 cm high with glass fronts

Carcass thickness 16 mm

 <p><b>Dresser unit with glass front 126 cm high</b> -neutral- 1 glass door 90.6 cm <b>G2/G2S</b> 2 adjustable glass shelves 2 drawers 12.6 cm, model-specific 1 fixed panel 8.8 cm, model-specific</p>		<b>AG 45 12 34 D</b>	R/L	1029	1029	1029	1029	1029	1029	1029	1029	1132	-	
		<i>extra charges for G5S</i>			162	162	162	162	162	162	162	162	162	-
		<b>AG 50 12 34 D</b>	R/L	1038	1038	1038	1038	1038	1038	1038	1038	1038	1142	-
		<i>extra charges for G5S</i>			155	155	155	155	155	155	155	155	155	155
		<b>AG 60 12 34 D</b>	R/L	1109	1109	1109	1109	1109	1109	1109	1109	1220	-	
		<i>extra charges for G5S</i>		173	173	173	173	173	173	173	173	173	173	-

G 1	G 2	G 2S
<b>G1 AKTIVglass frame</b> 991 Matt glass 992 Translucent black glass	<b>G2 Design front</b> 925 Frame White Agate/Matt glass 935 Premium W. Frame/Matt Glass 940 Macaron Col. Frame/Matt Glass 95 Light grey frame/matt glass 96 Silver Col. Frame/Matt Glass 960 Snow White Frame/Matt Glass 97 Black frame/black glass	<b>G2S aluminium, framed glass door</b> 988 aluminium black, Linea glass 994 Aluminium frame/clear glass 995 aluminium frame/black glass
G 5	G 5S	G 6
	<b>G5S aluminium, door with mullion</b> 996 Alum.frame/clear gl./cross bar	<b>G6 NEW SALON</b> 986 aluminium black, black glass 987 aluminium black, clear glass 989 aluminium matt, bronze-coloured black glass 990 aluminium matt, bronze-coloured clear glass



# Dresser units, 126 cm high with roller shutter

Carcase thickness 16 mm

The useable inside depth (bare dimension) for the following carcass depths is  
 36.1 cm – bare dimension 26.5 cm / 47.7 cm – bare dimension 38.1 cm  
 57.7 cm – bare dimension 48.1 cm / 63.2 cm – bare dimension 53.6 cm  
 ▲ = Types also available with 63.2 cm carcass depth (order no. ... replace ... 58 ... with 63)









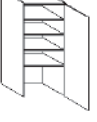
Order no.  
W H D

Hinge side:	Carcass depth	Decor groups									
		M10	M20	M30	M40	M50	M60	M70	M80	M90	
		<b>AJG 50 12 36 77</b>	1034	-	-	-	1989	-	2269	-	-
		<b>AJG 60 12 36 77</b>	1090	-	-	-	2122	-	2427	-	-
		<b>AJG 80 12 36 77</b>	1207	-	-	-	2391	-	2748	-	-
		<b>AJG 90 12 36 77</b>	1273	-	-	-	2534	-	2915	-	-
		No visible sides possible in other decor groups									
		<b>AJG 50 12 48 77</b>	1065	-	-	-	2177	-	2519	-	-
		<b>AJG 60 12 48 77</b>	1125	-	-	-	2328	-	2700	-	-
		<b>AJG 80 12 48 77</b>	1246	-	-	-	2632	-	3066	-	-
		<b>AJG 90 12 48 77</b>	1313	-	-	-	2792	-	3255	-	-
		No visible sides possible in other decor groups									
		<b>AJG 50 12 58 77</b>	▲ 1094	-	-	-	2339	-	2733	-	-
		<b>AJG 60 12 58 77</b>	▲ 1153	-	-	-	2505	-	2934	-	-
		<b>AJG 80 12 58 77</b>	▲ 1277	-	-	-	2840	-	3339	-	-
		<b>AJG 90 12 58 77</b>	▲ 1347	-	-	-	3014	-	3549	-	-
		optional accessory: only TAB-A**45 can be used as a pull-out shelf, and only 577 mm deep No visible sides possible in other decor groups									
		<b>AJG 50 12 36 78</b>	1097	-	-	-	2052	-	2333	-	-
		<b>AJG 60 12 36 78</b>	1156	-	-	-	2189	-	2494	-	-
		<b>AJG 80 12 36 78</b>	1282	-	-	-	2467	-	2822	-	-
		<b>AJG 90 12 36 78</b>	1353	-	-	-	2613	-	2995	-	-
		No visible sides possible in other decor groups									
		<b>AJG 50 12 48 78</b>	1129	-	-	-	2241	-	2582	-	-
		<b>AJG 60 12 48 78</b>	1190	-	-	-	2395	-	2766	-	-
		<b>AJG 80 12 48 78</b>	1320	-	-	-	2706	-	3140	-	-
		<b>AJG 90 12 48 78</b>	1392	-	-	-	2872	-	3335	-	-
		No visible sides possible in other decor groups									
		<b>AJG 50 12 58 78</b>	▲ 1158	-	-	-	2403	-	2796	-	-
		<b>AJG 60 12 58 78</b>	▲ 1220	-	-	-	2572	-	3000	-	-
		<b>AJG 80 12 58 78</b>	▲ 1353	-	-	-	2914	-	3413	-	-
		<b>AJG 90 12 58 78</b>	▲ 1427	-	-	-	3093	-	3628	-	-
		optional accessory: only TAB-A**45 can be used as a pull-out shelf, and only 577 mm deep No visible sides possible in other decor groups									
		<b>AJSGG 60 12 36</b>	2057	-	-	-	3090	-	3396	-	-
		<b>AJSGG 90 12 36</b>	2294	-	-	-	3555	-	3936	-	-
		Panel, guide profile and handle in the same colour as the roller shutter No visible sides possible in other decor groups									
		<b>AJSGG 60 12 48</b>	2092	-	-	-	3296	-	3668	-	-
		<b>AJSGG 90 12 48</b>	2334	-	-	-	3813	-	4276	-	-
		<b>AJSGG 60 12 58</b>	▲ 2122	-	-	-	3473	-	3902	-	-
		<b>AJSGG 90 12 58</b>	▲ 2368	-	-	-	4035	-	4570	-	-
		optional accessory: only TAB-A**45 can be used as a pull-out shelf, and only 577 mm deep No visible sides possible in other decor groups									

M 10	M 20	M 30	M 40	M 50
K M10 laminate				B M50 Velvet Lacquer S Microstructure lacquer
M 60	M 70	M 80	M 90	
	F M70 veneer / oak / walnut Z M70 Veneer / Bavaria			

# Dresser units, 132.5 cm high

□ = Models also available in 45.5/61 cm carcass depth (order no.: replace ... 55 ... with 45/61)

Order no.	W	H	D	Hinge side:	Carcass depth	Price groups															
						1	2	3	4	5	6	7	8	9							
906 126 126 149 	<b>Dresser unit 132.5 cm high</b>																				
	1 door 90.6 cm				A	45	132	34	R/L	791	830	849	986	1028	1043	1134	1247	-			
	3 adjustable shelves 2 drawers 12.6 cm 1 drawer 14.9 cm				A	50	132	34	R/L	791	830	849	986	1028	1043	1134	1247	-			
906 126 126 149 	<b>Dresser unit with glass door 132.5 cm high</b>																				
	-model-specific-			AG	45	132	34	RA	R/L	1009	1009	1015	1136	1136	1154	1217	1339	-			
	1 Framed glass door 90,6 cm 2 adjustable glass shelves 2 drawers 12.6 cm 1 drawer 14.9 cm			AG	50	132	34	RA	R/L	1009	1009	1015	1136	1136	1154	1217	1339	-			
				Available for: ARTE-B, ARTE-S, ATLANTA-B, ATLANTA-S, BERGEN, CASA-B, CASTELLO, CHALET-B, CHALET-S, CHICAGO, FRAME, LUGANO, LUX-B, MIAMI, NEW OPAL-M, NOBEL-B, NOBEL-S, OPAL-H, ORLANDO-B, ORLANDO-S, PALAZZO, PALERMO-B, PALERMO-S, ROMA-B, ROMA-S, SIGNUM-B, SOFIE-B, SOFIE-S, VINO, VIVA, YORK-B, YORK-S																	
				available glass versions: 90 = clear glass 93 = black glass 92 = matt glass 88 = Linea glass																	
906 126 126 149 	<b>Dresser unit with glass door 132.5 cm high</b>																				
	-model-specific-			AG	45	132	34	LS	R/L	1009	1009	1015	1136	1136	1154	1217	1339	-			
	1 semi-frameless glass door 90.6 cm 2 adjustable glass shelves 2 drawers 12.6 cm 1 drawer 14.9 cm			AG	50	132	34	LS	R/L	1009	1009	1015	1136	1136	1154	1217	1339	-			
				Available for: BAVARIA, EDITION, FENIX INOX, FLORENZ, GARDA, GENT, HPL PRO, MALMÖ, MODENA, MONTANA, MUNICH, NEVADA, OSLO 15, PADUA, PRIMEWOOD TOP, PUR, RESOPAL, RESOPAL PRO, RESOPAL PRO EDGE, RIVA, RUSTY OAK, SHERWOOD, SMART, SMART MIRROR, SMART-M, TESSIN 15, TIM, TIM 15, TOP, TREND, VILLAGE 15-B, VILLAGE 15-S																	
				available glass versions: 90 = clear glass 93 = black glass 92 = matt glass 88 = Linea glass																	
906 126 126 149 	<b>Dresser unit with glass front 132.5 cm high</b>																				
	-model-specific-			AG	45	132	34	SE	R/L	1038	1038	1046	1168	1168	1186	1248	1373	-			
	1 segment glass door 90.6 cm 2 adjustable glass shelves 2 drawers 12.6 cm 1 drawer 14.9 cm			AG	50	132	34	SE	R/L	1038	1038	1046	1168	1168	1186	1248	1373	-			
				Available for: EDITION, FENIX INOX, GARDA, HPL PRO, PRIMEWOOD TOP, PUR, RESOPAL, RESOPAL PRO, RESOPAL PRO EDGE, RIVA, SHERWOOD, SMART, SMART MIRROR, SMART-M, TOP, TREND																	
				available glass versions: 90 = clear glass 93 = black glass 92 = matt glass 88 = Linea glass																	
906 126 126 149 	<b>Dresser unit with glass door 132.5 cm high</b>																				
	-model-specific-			AG	45	132	34	LB	R/L	1038	1038	1046	1168	1168	1186	1248	1373	-			
	1 semi-frameless glass door 90.6 cm Glass width 5 cm 2 adjustable glass shelves 2 drawers 12.6 cm 1 drawer 14.9 cm			AG	50	132	34	LB	R/L	1038	1038	1046	1168	1168	1186	1248	1373	-			
				Available for: BAVARIA, EDITION, FENIX INOX, FLORENZ, GARDA, HPL PRO, MALMÖ, MODENA, MONTANA, MUNICH, NEVADA, PADUA, PRIMEWOOD TOP, PUR, RESOPAL, RESOPAL PRO, RESOPAL PRO EDGE, RIVA, RUSTY OAK, SHERWOOD, SMART, SMART MIRROR, SMART-M, TOP, TREND																	
				available glass versions: 90 = clear glass 93 = black glass 92 = matt glass 88 = Linea glass																	
906 126 126 149 	<b>Dresser unit with glass door 132.5 cm high</b>																				
	-model-specific-			AGS	45	132	34		R/L	-	-	1323	1436	1436	-	-	-	-			
	1 glass door 90.6 cm with mullions 2 adjustable glass shelves 2 drawers 12.6 cm 1 drawer 14.9 cm			AGS	50	132	34		R/L	-	-	1323	1436	1436	-	-	-	-			
				Available for: ARTE-B, ARTE-S, CHALET-B, CHALET-S, LUX-B, NOBEL-B, NOBEL-S, PALERMO-B, PALERMO-S, ROMA-B, ROMA-S, SOFIE-B, SOFIE-S, YORK-B, YORK-S																	
				available glass versions: 90 = clear glass 93 = black glass 92 = matt glass 88 = Linea glass																	
				Number of mullions/fields: Width 45 cm: 1 centre bar / 2 fields 13 cm x 13 cm each (W x H) Width 50 cm: 1 centre bar / 2 fields 15.5 cm x 13 cm each (W x H) Width 60 cm: 2 centre bars / 3 fields 13 cm x 13 cm each (W x H)																	
906 126 126 149 	<b>Dresser unit with glass door 132.5 cm high</b>																				
	-model-specific-			AGKS	45	132	34		R/L	-	-	1323	1436	1436	-	-	-	-			
	1 glass door 90.6 cm with crossbar 2 adjustable glass shelves 2 drawers 12.6 cm 1 drawer 14.9 cm			AGKS	50	132	34		R/L	-	-	1323	1436	1436	-	-	-	-			
				Available for: ARTE-B, ARTE-S, CHALET-B, CHALET-S, LUX-B, NOBEL-B, NOBEL-S, PALERMO-B, PALERMO-S, ROMA-B, ROMA-S, SOFIE-B, SOFIE-S, YORK-B, YORK-S																	
				available glass versions: 90 = clear glass 93 = black glass 92 = matt glass 88 = Linea glass																	
1319 	<b>Dresser unit 132.5 cm high</b>																				
	1 door 131.9 cm			A	45	132	55	2	R/L	□	411	426	485	663	696	730	800	879	-		
	3 adjustable shelves 1 fixed shelf Without bottom shelf Clear distance to fixed shelf: 52 cm			A	50	132	55	2	R/L	□	411	426	485	663	696	730	800	879	-		
				A	60	132	55	2	R/L	□	422	436	496	675	731	767	837	920	-		



# Dresser units, 132.5 cm high with glass fronts

Carcase thickness 16 mm

The useable inside depth (bare dimension) for the following carcass depths is  
 36.1 cm – bare dimension 26.5 cm / 47.7 cm – bare dimension 38.1 cm  
 57.7 cm – bare dimension 48.1 cm / 63.2 cm – bare dimension 53.6 cm  
 ▲ = Types also available with 63.2 cm carcass depth (order no. ... replace ... 58 ... with 63)

Order no.  
W H D

Hinge side: Carcass depth	Price groups								
	1	2	3	4	5	6	7	8	9
R/L	1220	1220	1220	1220	1220	1220	1220	1342	-
R/L	175	175	175	175	175	175	175	175	-
R/L	1227	1227	1227	1227	1227	1227	1227	1350	-
R/L	166	166	166	166	166	166	166	166	-
R/L	1303	1303	1303	1303	1303	1303	1303	1433	-
	189	189	189	189	189	189	189	189	-

906  
126  
126  
149



**Dresser unit with glass front**  
**132.5 cm high**  
 -neutral-  
 1 glass door 90.6 cm **G2/G2S**  
 2 adjustable glass shelves  
 2 drawers 12.6 cm, model-specific  
 1 drawer 14.9 cm, model-specific



**AG 45 132 34D**  
*extra charges for G5S*  
**AG 50 132 34D**  
*extra charges for G5S*  
**AG 60 132 34D**  
*extra charges for G5S*

G 1	G 2	G 2S
<b>G1 AKTIVglass frame</b> 991 Matt glass 992 Translucent black glass	<b>G2 Design front</b> 925 Frame White Agate/Matt glass 935 Premium W. Frame/Matt Glass 940 Macaron Col. Frame/Matt Glass 95 Light grey frame/matt glass 96 Silver Col. Frame/Matt Glass 960 Snow White Frame/Matt Glass 97 Black frame/black glass	<b>G2S aluminium, framed glass door</b> 988 aluminium black, Linea glass 994 Aluminium frame/clear glass 995 aluminium frame/black glass
<b>G 5</b>	<b>G 5S</b> G5S aluminium, door with mullion 996 Alum.frame/clear gl./cross bar	<b>G 6</b> <b>G6 NEW SALON</b> 986 aluminium black, black glass 987 aluminium black, clear glass 989 aluminium matt, bronze-coloured black glass 990 aluminium matt, bronze-coloured clear glass

## Additional equipment

□ = Models also available in 45.5/61 cm carcass depth (order no.: replace ... 55 ... with 45/61)



**Pull-out shelf with guide rails**  
 With locking function, full pull-out  
 „push to open“, shelf from decor group K  
 For carcass width 45 cm, 50 cm, 60 cm  
 For carcass width 80 cm, 90 cm  
 for carcass depths 45.5 cm and 55.5 cm  
 Load-bearing capacity depth 55.5 cm: 35 kg  
 Load-bearing capacity depth 45.5 cm: 35 kg  
 Load-bearing capacity depth 55.5 cm: 35 kg  
 Load-bearing capacity depth 45.5 cm: 35 kg  
 Load-bearing capacity depth 55.5 cm: 35 kg  
 Load-bearing capacity depth 45.5 cm: 35 kg  
 Load-bearing capacity depth 55.5 cm: 30 kg  
 Load-bearing capacity depth 45.5 cm: 30 kg  
 Load-bearing capacity depth 55.5 cm: 30 kg  
 Load-bearing capacity depth 45.5 cm: 30 kg

Order no.  
W H D

Hinge side: Carcass depth	Decor groups								
	M10	M20	M30	M40	M50	M60	M70	M80	M90



**Important:**  
 When installing in units with hinged doors always take wide angle hinges SA-90155E3 into consideration.

<b>TAB-AZ45 55</b>	220	-	-	-	-	-	-	-	-
<b>TAB-AZ45 45</b>	220	-	-	-	-	-	-	-	-
<b>TAB-AZ50 55</b>	225	-	-	-	-	-	-	-	-
<b>TAB-AZ50 45</b>	225	-	-	-	-	-	-	-	-
<b>TAB-AZ60 55</b>	234	-	-	-	-	-	-	-	-
<b>TAB-AZ60 45</b>	234	-	-	-	-	-	-	-	-
<b>TAB-AZ80 55</b>	282	-	-	-	-	-	-	-	-
<b>TAB-AZ80 45</b>	282	-	-	-	-	-	-	-	-
<b>TAB-AZ90 55</b>	298	-	-	-	-	-	-	-	-
<b>TAB-AZ90 45</b>	298	-	-	-	-	-	-	-	-

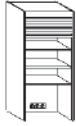
# Dresser units, 132.5 cm high with roller shutter

Carcase thickness 16 mm

The useable inside depth (bare dimension) for the following carcass depths is  
 36.1 cm – bare dimension 26.5 cm / 47.7 cm – bare dimension 38.1 cm  
 57.7 cm – bare dimension 48.1 cm / 63.2 cm – bare dimension 53.6 cm  
 ▲ = Types also available with 63.2 cm carcass depth (order no. ... replace ... 58 ... with 63)

Order no.  
W H D

Hinge side:	Carcass depth	Decor groups								
		M10	M20	M30	M40	M50	M60	M70	M80	M90



**Dresser unit with roller shutter**  
**132.5 cm high 36,1 cm deep**  
 Roller shutter stainless steel decor  
 2 adjustable shelves  
 1 fixed shelf 52 cm from below  
 3 sockets

AJG	50	132	36	77	1045	-	-	-	2024	-	2312	-	-
AJG	60	132	36	77	1102	-	-	-	2158	-	2472	-	-
AJG	80	132	36	77	1220	-	-	-	2433	-	2796	-	-
AJG	90	132	36	77	1286	-	-	-	2577	-	2966	-	-

No visible sides possible in other decor groups

as above, but  
**Dresser unit with roller shutter**  
**132.5 cm high 47,7 cm deep**

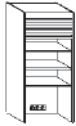
AJG	50	132	48	77	1078	-	-	-	2216	-	2566	-	-
AJG	60	132	48	77	1137	-	-	-	2368	-	2750	-	-
AJG	80	132	48	77	1258	-	-	-	2678	-	3120	-	-
AJG	90	132	48	77	1326	-	-	-	2839	-	3313	-	-

No visible sides possible in other decor groups

as above, but  
**Dresser unit with roller shutter**  
**132.5 cm high**

AJG	50	132	58	77	▲ 1107	-	-	-	2383	-	2786	-	-
AJG	60	132	58	77	▲ 1167	-	-	-	2549	-	2989	-	-
AJG	80	132	58	77	▲ 1291	-	-	-	2889	-	3398	-	-
AJG	90	132	58	77	▲ 1361	-	-	-	3064	-	3611	-	-

optional accessory:  
 only TAB-A\*\*45 can be used as a pull-out shelf, and only 577 mm deep  
 No visible sides possible in other decor groups



**Dresser unit with roller shutter**  
**132.5 cm high 36,1 cm deep**  
 Roller shutters black laminate  
 2 adjustable shelves  
 1 fixed shelf 52 cm from below  
 3 sockets

AJG	50	132	36	78	1109	-	-	-	2087	-	2375	-	-
AJG	60	132	36	78	1169	-	-	-	2225	-	2539	-	-
AJG	80	132	36	78	1294	-	-	-	2507	-	2870	-	-
AJG	90	132	36	78	1365	-	-	-	2655	-	3045	-	-

No visible sides possible in other decor groups

as above, but  
**Dresser unit with roller shutter**  
**132.5 cm high 47,7 cm deep**

AJG	50	132	48	78	1142	-	-	-	2280	-	2630	-	-
AJG	60	132	48	78	1203	-	-	-	2435	-	2816	-	-
AJG	80	132	48	78	1332	-	-	-	2752	-	3195	-	-
AJG	90	132	48	78	1406	-	-	-	2918	-	3392	-	-

No visible sides possible in other decor groups

as above, but  
**Dresser unit with roller shutter**  
**132.5 cm high**

AJG	50	132	58	78	▲ 1170	-	-	-	2446	-	2849	-	-
AJG	60	132	58	78	▲ 1234	-	-	-	2616	-	3056	-	-
AJG	80	132	58	78	▲ 1365	-	-	-	2963	-	3474	-	-
AJG	90	132	58	78	▲ 1439	-	-	-	3144	-	3690	-	-

optional accessory:  
 only TAB-A\*\*45 can be used as a pull-out shelf, and only 577 mm deep  
 No visible sides possible in other decor groups



**Dresser unit**  
**SMARTGLAS roller shutters**  
**132.5 cm high 36,1 cm deep**  
 2 adjustable shelves  
 1 fixed shelf 52 cm from below  
 3 sockets

AJSGG	60	132	36		2070	-	-	-	3126	-	3440	-	-
AJSGG	90	132	36		2307	-	-	-	3598	-	3987	-	-

Panel, guide profile and handle in the same colour as the roller shutter  
 No visible sides possible in other decor groups

as above, but  
**Dresser unit**  
**SMARTGLAS roller shutters**  
**132.5 cm high 47,7 cm deep**

AJSGG	60	132	48		2105	-	-	-	3337	-	3717	-	-
AJSGG	90	132	48		2347	-	-	-	3859	-	4333	-	-

as above, but  
**Dresser unit**  
**SMARTGLAS roller shutters**  
**132.5 cm high**

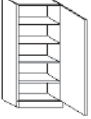







AJSGG	60	132	58		▲ 2135	-	-	-	3518	-	3957	-	-
AJSGG	90	132	58		▲ 2382	-	-	-	4085	-	4632	-	-

optional accessory:  
 only TAB-A\*\*45 can be used as a pull-out shelf, and only 577 mm deep  
 No visible sides possible in other decor groups

M 10	M 20	M 30	M 40	M 50
K M10 laminate				B M50 Velvet Lacquer S Microstructur lacquer
M 60	M 70	M 80	M 90	
	F M70 veneer / oak / walnut Z M70 Veneer / Bavaria			


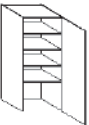
# Dresser units, 139 cm high

□ = Models also available in 45,5/61 cm carcass depth (order no.: replace ... 55 ... with 45/61)

	Order no. W H D	Hinge side: Carcass depth	Price groups								
			1	2	3	4	5	6	7	8	9
1296 88  <p><b>Dresser unit 139 cm high</b> 1 door 129.6 cm 4 adjustable shelves 1 fixed panel 8.8 cm</p>	<b>A 45 13 34 1</b>	R/L	442	483	495	628	666	686	771	848	-
	<b>A 50 13 34 1</b>	R/L	442	483	495	628	666	686	771	848	-
	<b>A 60 13 34 1</b>	R/L	498	515	532	682	720	740	799	879	-
906 126 126 126 88  <p><b>Dresser unit 139 cm high</b> 1 door 90.6 cm 3 adjustable shelves 3 drawers 12.6 cm 1 fixed panel 8.8 cm</p>	<b>A 45 13 34</b>	R/L	721	762	774	906	946	965	1049	1154	-
	<b>A 50 13 34</b>	R/L	721	762	774	906	946	965	1049	1154	-
	<b>A 60 13 34</b>	R/L	794	810	828	977	1017	1037	1095	1205	-
906 126 126 126 88  <p><b>Dresser unit with glass door 139 cm high</b> -model-specific- 1 Framed glass door 90,6 cm 2 adjustable glass shelves 3 drawers 12.6 cm 1 fixed panel 8.8 cm</p>	<b>AG 45 13 34 RA</b>	R/L	925	925	933	1050	1050	1068	1126	1239	-
	<b>AG 50 13 34 RA</b>	R/L	925	925	933	1050	1050	1068	1126	1239	-
	<b>AG 60 13 34 RA</b>	R/L	983	983	989	1137	1137	1154	1214	1335	-
<p><b>Available for:</b> ARTE-B, ARTE-S, ATLANTA-B, ATLANTA-S, BERGEN, CASA-B, CASTELLO, CHALET-B, CHALET-S, CHICAGO, FRAME, LUGANO, LUX-B, MIAMI, NEW OPAL-M, NOBEL-B, NOBEL-S, OPAL-H, ORLANDO-B, ORLANDO-S, PALAZZO, PALERMO-B, PALERMO-S, ROMA-B, ROMA-S, SIGNUM-B, SOFIE-B, SOFIE-S, VINO, VIVA, YORK-B, YORK-S</p> <p><b>available glass versions:</b> 90 = clear glass 93 = black glass 92 = matt glass 88 = Linea glass</p>											
906 126 126 126 88  <p><b>Dresser unit with glass door 139 cm high</b> -model-specific- 1 semi-frameless glass door 90.6 cm 2 adjustable glass shelves 3 drawers 12.6 cm 1 fixed panel 8.8 cm</p>	<b>AG 45 13 34 LS</b>	R/L	925	925	933	1050	1050	1068	1126	1239	-
	<b>AG 50 13 34 LS</b>	R/L	925	925	933	1050	1050	1068	1126	1239	-
	<b>AG 60 13 34 LS</b>	R/L	983	983	989	1137	1137	1154	1214	1335	-
<p><b>Available for:</b> BAVARIA, EDITION, FENIX INOX, FLORENZ, GARDA, GENT, HPL PRO, MALMÖ, MODENA, MONTANA, MUNICH, NEVADA, OSLO 15, PADUA, PRIMEWOOD TOP, PUR, RESOPAL, RESOPAL PRO, RESOPAL PRO EDGE, RIVA, RUSTY OAK, SHERWOOD, SMART, SMART MIRROR, SMART-M, TESSIN 15, TIM, TIM 15, TOP, TREND, VILLAGE 15-B, VILLAGE 15-S</p> <p><b>available glass versions:</b> 90 = clear glass 93 = black glass 92 = matt glass 88 = Linea glass</p>											
906 126 126 126 88  <p><b>Dresser unit with glass door 139 cm high</b> -model-specific- 1 segment glass door 90.6 cm 2 adjustable glass shelves 3 drawers 12.6 cm 1 fixed panel 8.8 cm</p>	<b>AG 45 13 34 SE</b>	R/L	957	957	967	1082	1082	1100	1154	1269	-
	<b>AG 50 13 34 SE</b>	R/L	957	957	967	1082	1082	1100	1154	1269	-
	<b>AG 60 13 34 SE</b>	R/L	1015	1015	1021	1170	1170	1186	1244	1368	-
<p><b>Available for:</b> EDITION, FENIX INOX, GARDA, HPL PRO, PRIMEWOOD TOP, PUR, RESOPAL, RESOPAL PRO, RESOPAL PRO EDGE, RIVA, SHERWOOD, SMART, SMART MIRROR, SMART-M, TOP, TREND</p> <p><b>available glass versions:</b> 90 = clear glass 93 = black glass 92 = matt glass 88 = Linea glass</p>											
906 126 126 126 88  <p><b>Dresser unit with glass door 139 cm high</b> -model-specific- 1 semi-frameless glass door 90.6 cm Glass width 5 cm 2 adjustable glass shelves 3 drawers 12.6 cm 1 fixed panel 8.8 cm</p>	<b>AG 45 13 34 LB</b>	R/L	957	957	967	1082	1082	1100	1154	1269	-
	<b>AG 50 13 34 LB</b>	R/L	957	957	967	1082	1082	1100	1154	1269	-
	<b>AG 60 13 34 LB</b>	R/L	1015	1015	1021	1170	1170	1186	1244	1368	-
<p><b>Available for:</b> BAVARIA, EDITION, FENIX INOX, FLORENZ, GARDA, HPL PRO, MALMÖ, MODENA, MONTANA, MUNICH, NEVADA, PADUA, PRIMEWOOD TOP, PUR, RESOPAL, RESOPAL PRO, RESOPAL PRO EDGE, RIVA, RUSTY OAK, SHERWOOD, SMART, SMART MIRROR, SMART-M, TOP, TREND</p> <p><b>available glass versions:</b> 90 = clear glass 93 = black glass 92 = matt glass 88 = Linea glass</p>											
906 126 126 126 88  <p><b>Dresser unit with glass door 139 cm high</b> -model-specific- 1 glass door 90.6 cm with mullions 2 adjustable glass shelves 3 drawers 12.6 cm 1 fixed panel 8.8 cm</p>	<b>AGS 45 13 34</b>	R/L	-	-	1242	1349	1349	-	-	-	-
	<b>AGS 50 13 34</b>	R/L	-	-	1242	1349	1349	-	-	-	-
	<b>AGS 60 13 34</b>	R/L	-	-	1296	1437	1437	-	-	-	-
<p><b>Available for:</b> ARTE-B, ARTE-S, CHALET-B, CHALET-S, LUX-B, NOBEL-B, NOBEL-S, PALERMO-B, PALERMO-S, ROMA-B, ROMA-S, SOFIE-B, SOFIE-S, YORK-B, YORK-S</p> <p><b>available glass versions:</b> 90 = clear glass 93 = black glass 92 = matt glass 88 = Linea glass</p> <p><b>Number of mullions/fields:</b> Width 45 cm: 1 centre bar / 2 fields 13 cm x 13 cm each (W x H) Width 50 cm: 1 centre bar / 2 fields 15,5 cm x 13 cm each (W x H) Width 60 cm: 2 centre bars / 3 fields 13 cm x 13 cm each (W x H)</p>											
906 126 126 126 88  <p><b>Dresser unit with glass door 139 cm high</b> -model-specific- 1 glass door 90.6 cm with crossbar 2 adjustable glass shelves 3 drawers 12.6 cm 1 fixed panel 8.8 cm</p>	<b>AGKS 45 13 34</b>	R/L	-	-	1242	1349	1349	-	-	-	-
	<b>AGKS 50 13 34</b>	R/L	-	-	1242	1349	1349	-	-	-	-
	<b>AGKS 60 13 34</b>	R/L	-	-	1296	1437	1437	-	-	-	-
<p><b>Available for:</b> ARTE-B, ARTE-S, CHALET-B, CHALET-S, LUX-B, NOBEL-B, NOBEL-S, PALERMO-B, PALERMO-S, ROMA-B, ROMA-S, SOFIE-B, SOFIE-S, YORK-B, YORK-S</p> <p><b>available glass versions:</b> 90 = clear glass 93 = black glass 92 = matt glass 88 = Linea glass</p>											



## Dresser units, 139 cm high

□ = Models also available in 45.5/61 cm carcass depth (order no.: replace ... 55 ... with 45/61)

	Order no. W H D	Hinge side: R/L	Carcass depth	Price groups								
				1	2	3	4	5	6	7	8	9
 <b>Dresser unit with glass door</b> <b>139 cm high</b> 1 glass door 138.4 cm 2 adjustable glass shelves 1 fixed shelf Without bottom shelf	<b>AGL 45 13 34</b>	R/L		925	925	933	1050	1050	1068	1126	1239	-
	<b>AGL 50 13 34</b>	R/L		925	925	933	1050	1050	1068	1126	1239	-
	<b>AGL 60 13 34</b>	R/L		983	983	989	1137	1137	1154	1214	1335	-
	Available for: ARTE-B, ARTE-S, CHALET-B, CHALET-S, LUX-B, NOBEL-B, NOBEL-S, PALERMO-B, PALERMO-S, ROMA-B, ROMA-S, SOFIE-B, SOFIE-S, YORK-B, YORK-S available glass versions: 90 = clear glass 93 = black glass 92 = matt glass 88 = Linea glass											
 <b>Dresser unit 139 cm high</b> 1 door 138.4 cm 3 adjustable shelves 1 fixed shelf Without bottom shelf Clear distance to fixed shelf: 52 cm	<b>A 45 13 55 2</b>	R/L	<input type="checkbox"/>	411	426	485	663	696	730	800	879	-
	<b>A 50 13 55 2</b>	R/L	<input type="checkbox"/>	411	426	485	663	696	730	800	879	-
	<b>A 60 13 55 2</b>	R/L	<input type="checkbox"/>	422	436	496	675	731	767	837	920	-

## Dresser units, 139 cm high with glass fronts


Carcass thickness 16 mm

 <b>Dresser unit with glass front</b> <b>139 cm high</b> -neutral- 1 glass door 90.6 cm <b>G2/G2S</b> 2 adjustable glass shelves 3 drawers 12.6 cm, model-specific 1 fixed panel 8.8 cm, model-specific		<b>AG 45 13 34 D</b>	R/L	1132	1132	1132	1132	1132	1132	1132	1245	-	
		<i>extra charges for G5S</i>	R/L	183	183	183	183	183	183	183	183	183	-
		<b>AG 50 13 34 D</b>	R/L	1140	1140	1140	1140	1140	1140	1140	1140	1254	-
		<i>extra charges for G5S</i>	R/L	176	176	176	176	176	176	176	176	176	-
		<b>AG 60 13 34 D</b>	R/L	1216	1216	1216	1216	1216	1216	1216	1338	-	
		<i>extra charges for G5S</i>		191	191	191	191	191	191	191	191	-	

G 1	G 2	G 2S
<b>G1 AKTIVglass frame</b> 991 Matt glass 992 Translucent black glass	<b>G2 Design front</b> 925 Frame White Agate/Matt glass 935 Premium W. Frame/Matt Glass 940 Macaron Col. Frame/Matt Glass 95 Light grey frame/matt glass 96 Silver Col. Frame/Matt Glass 960 Snow White Frame/Matt Glass 97 Black frame/black glass	<b>G2S aluminium, framed glass door</b> 988 aluminium black, Linea glass 994 Aluminium frame/clear glass 995 aluminium frame/black glass
G 5	G 5S	G 6
	G5S aluminium, door with mullion 996 Alum.frame/clear gl./cross bar	<b>G6 NEW SALON</b> 986 aluminium black, black glass 987 aluminium black, clear glass 989 aluminium matt, bronze-coloured black glass 990 aluminium matt, bronze-coloured clear glass

## Additional equipment

□ = Models also available in 45.5/61 cm carcass depth (order no.: replace ... 55 ... with 45/61)












	Order no. W H D	Hinge side: R/L	Carcass depth	Decor groups									
				M10	M20	M30	M40	M50	M60	M70	M80	M90	
 <b>Pull-out shelf with guide rails</b> With locking function, full pull-out „push to open“, shelf from decor group K For carcass width 45 cm, 50 cm, 60 cm For carcass width 80 cm, 90 cm for carcass depths 45.5 cm and 55.5 cm  Load-bearing capacity depth 55.5 cm: 35 kg Load-bearing capacity depth 45.5 cm: 35 kg Load-bearing capacity depth 55.5 cm: 35 kg Load-bearing capacity depth 45.5 cm: 35 kg Load-bearing capacity depth 55.5 cm: 35 kg Load-bearing capacity depth 45.5 cm: 35 kg Load-bearing capacity depth 55.5 cm: 30 kg Load-bearing capacity depth 45.5 cm: 30 kg Load-bearing capacity depth 55.5 cm: 30 kg Load-bearing capacity depth 45.5 cm: 30 kg				<b>Important:</b> When installing in units with hinged doors always take wide angle hinges <b>SA-90155E3</b> into consideration.									
	<b>TAB-AZ45 55</b>			220	-	-	-	-	-	-	-	-	-
	<b>TAB-AZ45 45</b>			220	-	-	-	-	-	-	-	-	-
	<b>TAB-AZ50 55</b>			225	-	-	-	-	-	-	-	-	-
	<b>TAB-AZ50 45</b>			225	-	-	-	-	-	-	-	-	-
	<b>TAB-AZ60 55</b>			234	-	-	-	-	-	-	-	-	-
	<b>TAB-AZ60 45</b>			234	-	-	-	-	-	-	-	-	-
	<b>TAB-AZ80 55</b>			282	-	-	-	-	-	-	-	-	-
	<b>TAB-AZ80 45</b>			282	-	-	-	-	-	-	-	-	-
	<b>TAB-AZ90 55</b>			298	-	-	-	-	-	-	-	-	-
	<b>TAB-AZ90 45</b>			298	-	-	-	-	-	-	-	-	-

# Dresser units, 139 cm high with roller shutter

Carcase thickness 16 mm

The useable inside depth (bare dimension) for the following carcass depths is  
 36.1 cm – bare dimension 26.5 cm / 47.7 cm – bare dimension 38.1 cm  
 57.7 cm – bare dimension 48.1 cm / 63.2 cm – bare dimension 53.6 cm  
 ▲ = Types also available with 63.2 cm carcass depth (order no. ... replace ... 58 ... with 63)

Order no.  
W H D










Hinge side:	Carcass depth	Decor groups									
		M10	M20	M30	M40	M50	M60	M70	M80	M90	
 <p><b>Dresser unit with roller shutter</b>  <b>139 cm high 36,1 cm deep</b>                      Roller shutter stainless steel decor                      2 adjustable shelves                      1 fixed shelf 52 cm from below                      3 sockets</p>		AJG 50 13 36 77	1058	-	-	-	2057	-	2354	-	-
		AJG 60 13 36 77	1114	-	-	-	2195	-	2516	-	-
		AJG 80 13 36 77	1233	-	-	-	2473	-	2845	-	-
		AJG 90 13 36 77	1299	-	-	-	2619	-	3017	-	-
		 No visible sides possible in other decor groups									
<p>as above, but  <b>Dresser unit with roller shutter</b>  <b>139 cm high 47,7 cm deep</b></p>		AJG 50 13 48 77	1091	-	-	-	2256	-	2615	-	-
		AJG 60 13 48 77	1150	-	-	-	2409	-	2801	-	-
		AJG 80 13 48 77	1271	-	-	-	2722	-	3175	-	-
		AJG 90 13 48 77	1340	-	-	-	2885	-	3370	-	-
		 No visible sides possible in other decor groups									
<p>as above, but  <b>Dresser unit with roller shutter</b>  <b>139 cm high</b></p>		AJG 50 13 58 77	▲ 1119	-	-	-	2425	-	2840	-	-
		AJG 60 13 58 77	▲ 1180	-	-	-	2595	-	3044	-	-
		AJG 80 13 58 77	▲ 1305	-	-	-	2937	-	3459	-	-
		AJG 90 13 58 77	▲ 1375	-	-	-	3115	-	3673	-	-
		 optional accessory: only TAB-A**45 can be used as a pull-out shelf, and only 577 mm deep No visible sides possible in other decor groups									
 <p><b>Dresser unit with roller shutter</b>  <b>139 cm high 36,1 cm deep</b>                      Roller shutters black laminate                      2 adjustable shelves                      1 fixed shelf 52 cm from below                      3 sockets</p>		AJG 50 13 36 78	1121	-	-	-	2121	-	2418	-	-
		AJG 60 13 36 78	1181	-	-	-	2261	-	2583	-	-
		AJG 80 13 36 78	1307	-	-	-	2547	-	2919	-	-
		AJG 90 13 36 78	1378	-	-	-	2698	-	3096	-	-
		 No visible sides possible in other decor groups									
<p>as above, but  <b>Dresser unit with roller shutter</b>  <b>139 cm high 47,7 cm deep</b></p>		AJG 50 13 48 78	1154	-	-	-	2319	-	2679	-	-
		AJG 60 13 48 78	1217	-	-	-	2476	-	2866	-	-
		AJG 80 13 48 78	1346	-	-	-	2796	-	3249	-	-
		AJG 90 13 48 78	1418	-	-	-	2965	-	3448	-	-
		 No visible sides possible in other decor groups									
<p>as above, but  <b>Dresser unit with roller shutter</b>  <b>139 cm high</b></p>		AJG 50 13 58 78	▲ 1183	-	-	-	2489	-	2903	-	-
		AJG 60 13 58 78	▲ 1247	-	-	-	2662	-	3111	-	-
		AJG 80 13 58 78	▲ 1379	-	-	-	3011	-	3533	-	-
		AJG 90 13 58 78	▲ 1453	-	-	-	3195	-	3752	-	-
		 optional accessory: only TAB-A**45 can be used as a pull-out shelf, and only 577 mm deep No visible sides possible in other decor groups									
 <p><b>Dresser unit</b>  <b>SMARTGLAS roller shutters</b>  <b>139 cm high 36,1 cm deep</b>                      2 adjustable shelves                      1 fixed shelf 52 cm from below                      3 sockets</p>		AJSGG 60 13 36	2083	-	-	-	3163	-	3484	-	-
		AJSGG 90 13 36	2320	-	-	-	3640	-	4038	-	-
		 Panel, guide profile and handle in the same colour as the roller shutter No visible sides possible in other decor groups									
<p>as above, but  <b>Dresser unit</b>  <b>SMARTGLAS roller shutters</b>  <b>139 cm high 47,7 cm deep</b></p>		AJSGG 60 13 48	2118	-	-	-	3377	-	3768	-	-
		AJSGG 90 13 48	2361	-	-	-	3906	-	4391	-	-
<p>as above, but  <b>Dresser unit</b>  <b>SMARTGLAS roller shutters</b>  <b>139 cm high</b></p>		AJSGG 60 13 58	▲ 2148	-	-	-	3563	-	4012	-	-
		AJSGG 90 13 58	▲ 2396	-	-	-	4136	-	4694	-	-
		 optional accessory: only TAB-A**45 can be used as a pull-out shelf, and only 577 mm deep No visible sides possible in other decor groups									

M 10	M 20	M 30	M 40	M 50
K M10 laminate				B M50 Velvet Lacquer S Microstructure lacquer
M 60	M 70	M 80	M 90	
	F M70 veneer / oak / walnut Z M70 Veneer / Bavaria			



# Dresser units, 145.5 cm high

□ = Models also available in 45.5/61 cm carcass depth (order no.: replace ... 55 ... with 45/61)

	Order no.	W	H	D	Hinge side:	Carcass depth	Price groups										
							1	2	3	4	5	6	7	8	9		
 <p><b>Dresser unit 145.5 cm high</b> 1 door 90.6 cm 3 adjustable shelves 3 drawers 12.6 cm 1 drawer 14.9 cm</p>	<b>A</b>	<b>45</b>	<b>145</b>	<b>34</b>	R/L		898	939	954	1088	1131	1147	1236	1360	-		
	<b>A</b>	<b>50</b>	<b>145</b>	<b>34</b>	R/L		898	939	954	1088	1131	1147	1236	1360	-		
	<b>A</b>	<b>60</b>	<b>145</b>	<b>34</b>	R/L		975	990	1012	1163	1205	1225	1287	1416	-		
 <p><b>Dresser unit with glass door 145.5 cm high</b> -model-specific- 1 Framed glass door 90,6 cm 2 adjustable glass shelves 3 drawers 12.6 cm 1 drawer 14.9 cm</p>	<b>AG</b>	<b>45</b>	<b>145</b>	<b>34</b>	<b>RA</b>	R/L	1112	1112	1121	1239	1239	1257	1317	1449	-		
	<b>AG</b>	<b>50</b>	<b>145</b>	<b>34</b>	<b>RA</b>	R/L	1112	1112	1121	1239	1239	1257	1317	1449	-		
	<b>AG</b>	<b>60</b>	<b>145</b>	<b>34</b>	<b>RA</b>	R/L	1173	1173	1182	1331	1331	1347	1409	1550	-		
<p><b>Available for:</b> ARTE-B, ARTE-S, ATLANTA-B, ATLANTA-S, BERGEN, CASA-B, CASTELLO, CHALET-B, CHALET-S, CHICAGO, FRAME, LUGANO, LUX-B, MIAMI, NEW OPAL-M, NOBEL-B, NOBEL-S, OPAL-H, ORLANDO-B, ORLANDO-S, PALAZZO, PALERMO-B, PALERMO-S, ROMA-B, ROMA-S, SIGNUM-B, SOFIE-B, SOFIE-S, VINO, VIVA, YORK-B, YORK-S</p> <p><b>available glass versions:</b> 90 = clear glass 93 = black glass 92 = matt glass 88 = Linea glass</p>																	
 <p><b>Dresser unit with glass door 145.5 cm high</b> -model-specific- 1 semi-frameless glass door 90.6 cm 2 adjustable glass shelves 3 drawers 12.6 cm 1 drawer 14.9 cm</p>	<b>AG</b>	<b>45</b>	<b>145</b>	<b>34</b>	<b>LS</b>	R/L	1112	1112	1121	1239	1239	1257	1317	1449	-		
	<b>AG</b>	<b>50</b>	<b>145</b>	<b>34</b>	<b>LS</b>	R/L	1112	1112	1121	1239	1239	1257	1317	1449	-		
	<b>AG</b>	<b>60</b>	<b>145</b>	<b>34</b>	<b>LS</b>	R/L	1173	1173	1182	1331	1331	1347	1409	1550	-		
<p><b>Available for:</b> BAVARIA, EDITION, FENIX INOX, FLORENZ, GARDA, GENT, HPL PRO, MALMÖ, MODENA, MONTANA, MUNICH, NEVADA, OSLO 15, PADUA, PRIMEWOOD TOP, PUR, RESOPAL, RESOPAL PRO, RESOPAL PRO EDGE, RIVA, RUSTY OAK, SHERWOOD, SMART, SMART MIRROR, SMART-M, TESSIN 15, TIM, TIM 15, TOP, TREND, VILLAGE 15-B, VILLAGE 15-S</p> <p><b>available glass versions:</b> 90 = clear glass 93 = black glass 92 = matt glass 88 = Linea glass</p>																	
 <p><b>Dresser unit with glass door 145.5 cm high</b> -model-specific- 1 segment glass door 90.6 cm 2 adjustable glass shelves 3 drawers 12.6 cm 1 drawer 14.9 cm</p>	<b>AG</b>	<b>45</b>	<b>145</b>	<b>34</b>	<b>SE</b>	R/L	1142	1142	1151	1271	1271	1289	1347	1482	-		
	<b>AG</b>	<b>50</b>	<b>145</b>	<b>34</b>	<b>SE</b>	R/L	1142	1142	1151	1271	1271	1289	1347	1482	-		
	<b>AG</b>	<b>60</b>	<b>145</b>	<b>34</b>	<b>SE</b>	R/L	1202	1202	1212	1359	1359	1380	1438	1582	-		
<p><b>Available for:</b> EDITION, FENIX INOX, GARDA, HPL PRO, PRIMEWOOD TOP, PUR, RESOPAL, RESOPAL PRO, RESOPAL PRO EDGE, RIVA, SHERWOOD, SMART, SMART MIRROR, SMART-M, TOP, TREND</p> <p><b>available glass versions:</b> 90 = clear glass 93 = black glass 92 = matt glass 88 = Linea glass</p>																	
 <p><b>Dresser unit with glass door 145.5 cm high</b> -model-specific- 1 semi-frameless glass door 90.6 cm Glass width 5 cm 2 adjustable glass shelves 3 drawers 12.6 cm 1 drawer 14.9 cm</p>	<b>AG</b>	<b>45</b>	<b>145</b>	<b>34</b>	<b>LB</b>	R/L	1142	1142	1151	1271	1271	1289	1347	1482	-		
	<b>AG</b>	<b>50</b>	<b>145</b>	<b>34</b>	<b>LB</b>	R/L	1142	1142	1151	1271	1271	1289	1347	1482	-		
	<b>AG</b>	<b>60</b>	<b>145</b>	<b>34</b>	<b>LB</b>	R/L	1202	1202	1212	1359	1359	1380	1438	1582	-		
<p><b>Available for:</b> BAVARIA, EDITION, FENIX INOX, FLORENZ, GARDA, HPL PRO, MALMÖ, MODENA, MONTANA, MUNICH, NEVADA, PADUA, PRIMEWOOD TOP, PUR, RESOPAL, RESOPAL PRO, RESOPAL PRO EDGE, RIVA, RUSTY OAK, SHERWOOD, SMART, SMART MIRROR, SMART-M, TOP, TREND</p> <p><b>available glass versions:</b> 90 = clear glass 93 = black glass 92 = matt glass 88 = Linea glass</p>																	
 <p><b>Dresser unit with glass door 145.5 cm high</b> -model-specific- 1 glass door 90.6 cm with mullions 2 adjustable glass shelves 3 drawers 12.6 cm 1 drawer 14.9 cm</p>	<b>AGS</b>	<b>45</b>	<b>145</b>	<b>34</b>		R/L	-	-	1430	1540	1540	-	-	-	-		
	<b>AGS</b>	<b>50</b>	<b>145</b>	<b>34</b>		R/L	-	-	1430	1540	1540	-	-	-	-		
	<b>AGS</b>	<b>60</b>	<b>145</b>	<b>34</b>		R/L	-	-	1488	1628	1628	-	-	-	-		
<p><b>Available for:</b> ARTE-B, ARTE-S, CHALET-B, CHALET-S, LUX-B, NOBEL-B, NOBEL-S, PALERMO-B, PALERMO-S, ROMA-B, ROMA-S, SOFIE-B, SOFIE-S, YORK-B, YORK-S</p> <p><b>available glass versions:</b> 90 = clear glass 93 = black glass 92 = matt glass 88 = Linea glass</p> <p><b>Number of mullions/fields:</b> Width 45 cm: 1 centre bar / 2 fields 13 cm x 13 cm each (W x H) Width 50 cm: 1 centre bar / 2 fields 15.5 cm x 13 cm each (W x H) Width 60 cm: 2 centre bars / 3 fields 13 cm x 13 cm each (W x H)</p>																	
 <p><b>Dresser unit with glass door 145.5 cm high</b> -model-specific- 1 glass door 90.6 cm with crossbar 2 adjustable glass shelves 3 drawers 12.6 cm 1 drawer 14.9 cm</p>	<b>AGKS</b>	<b>45</b>	<b>145</b>	<b>34</b>		R/L	-	-	1430	1540	1540	-	-	-	-		
	<b>AGKS</b>	<b>50</b>	<b>145</b>	<b>34</b>		R/L	-	-	1430	1540	1540	-	-	-	-		
	<b>AGKS</b>	<b>60</b>	<b>145</b>	<b>34</b>		R/L	-	-	1488	1628	1628	-	-	-	-		
<p><b>Available for:</b> ARTE-B, ARTE-S, CHALET-B, CHALET-S, LUX-B, NOBEL-B, NOBEL-S, PALERMO-B, PALERMO-S, ROMA-B, ROMA-S, SOFIE-B, SOFIE-S, YORK-B, YORK-S</p> <p><b>available glass versions:</b> 90 = clear glass 93 = black glass 92 = matt glass 88 = Linea glass</p>																	
 <p><b>Dresser unit 145.5 cm high</b> 1 door 144.9 cm 3 adjustable shelves 1 fixed shelf Without bottom shelf Clear distance to fixed shelf: 52 cm</p>	<b>A</b>	<b>45</b>	<b>145</b>	<b>55</b>	<b>2</b>	R/L	□	411	426	485	663	696	730	800	879	-	
	<b>A</b>	<b>50</b>	<b>145</b>	<b>55</b>	<b>2</b>	R/L	□	411	426	485	663	696	730	800	879	-	
	<b>A</b>	<b>60</b>	<b>145</b>	<b>55</b>	<b>2</b>	R/L	□	422	436	496	675	731	767	837	920	-	
 <p><b>Dresser bar unit with side-hung doors 1428 cm high as dresser unit on top of base unit</b> 2 doors 142.6 cm with wide angle hinges 3 adjustable shelves 1 pull-out shelf</p>	<b>NEW</b>	<b>ABT</b>	<b>90</b>	<b>14</b>	<b>55</b>	<b>1</b>	▲	877	929	1003	1034	1079	1106	1147	1193	-	

# Dresser units, 145.5 cm high with glass fronts

Carcase thickness 16 mm

906  
126  
126  
126  
149



**Dresser unit with glass front**  
**145.5 cm high**  
-neutral-  
1 glass door 90.6 cm **G2/G2S**  
2 adjustable glass shelves  
3 drawers 12.6 cm, model-specific  
1 drawer 14.9 cm, model-specific



Order no.  
W H D

**AG 45 145 34D**  
*extra charges for G5S*  
**AG 50 145 34D**  
*extra charges for G5S*  
**AG 60 145 34D**  
*extra charges for G5S*

Hinge side: Carcase depth	Price groups								
	1	2	3	4	5	6	7	8	9
R/L	1323	1323	1323	1323	1323	1323	1323	1455	-
R/L	195	195	195	195	195	195	195	195	-
R/L	1332	1332	1332	1332	1332	1332	1332	1465	-
R/L	187	187	187	187	187	187	187	187	-
R/L	1409	1409	1409	1409	1409	1409	1409	1550	-
	209	209	209	209	209	209	209	209	-

G 1	G 2	G 2S
<b>G1 AKTIVglass frame</b> 991 Matt glass 992 Translucent black glass	<b>G2 Design front</b> 925 Frame White Agate/Matt glass 935 Premium W. Frame/Matt Glass 940 Macaron Col. Frame/Matt Glass 95 Light grey frame/matt glass 96 Silver Col. Frame/Matt Glass 960 Snow White Frame/Matt Glass 97 Black frame/black glass	<b>G2S aluminium, framed glass door</b> 988 aluminium black, Linea glass 994 Aluminium frame/clear glass 995 aluminium frame/black glass
<b>G 5</b>	<b>G 5S</b> G5S aluminium, door with mullion 996 Alum.frame/clear gl./cross bar	<b>G 6</b> <b>G6 NEW SALON</b> 986 aluminium black, black glass 987 aluminium black, clear glass 989 aluminium matt, bronze-coloured black glass 990 aluminium matt, bronze-coloured clear glass

## Additional equipment

□ = Models also available in 45.5/61 cm carcase depth (order no.: replace ... 55 ... with 45/61)



**Pull-out shelf with guide rails**  
With locking function, full pull-out  
„push to open“, shelf from decor group K  
For carcase width 45 cm, 50 cm, 60 cm  
For carcase width 80 cm, 90 cm  
for carcase depths 45.5 cm and 55.5 cm

Load-bearing capacity depth 55.5 cm: 35 kg  
Load-bearing capacity depth 45.5 cm: 35 kg  
Load-bearing capacity depth 55.5 cm: 35 kg  
Load-bearing capacity depth 45.5 cm: 35 kg  
Load-bearing capacity depth 55.5 cm: 35 kg  
Load-bearing capacity depth 45.5 cm: 35 kg  
Load-bearing capacity depth 55.5 cm: 30 kg  
Load-bearing capacity depth 45.5 cm: 30 kg  
Load-bearing capacity depth 55.5 cm: 30 kg  
Load-bearing capacity depth 45.5 cm: 30 kg

Order no.  
W H D



**Important:**  
When installing in units with hinged doors always take wide angle hinges SA-90155E3 into consideration.

Hinge side: Carcase depth	Decor groups								
	M10	M20	M30	M40	M50	M60	M70	M80	M90
	TAB-AZ45 55	220	-	-	-	-	-	-	-
	TAB-AZ45 45	220	-	-	-	-	-	-	-
	TAB-AZ50 55	225	-	-	-	-	-	-	-
	TAB-AZ50 45	225	-	-	-	-	-	-	-
	TAB-AZ60 55	234	-	-	-	-	-	-	-
	TAB-AZ60 45	234	-	-	-	-	-	-	-
	TAB-AZ80 55	282	-	-	-	-	-	-	-
	TAB-AZ80 45	282	-	-	-	-	-	-	-
	TAB-AZ90 55	298	-	-	-	-	-	-	-
	TAB-AZ90 45	298	-	-	-	-	-	-	-



# Dresser units, 145.5 cm high with roller shutter

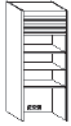
Carcase thickness 16 mm

The useable inside depth (bare dimension) for the following carcass depths is  
 36.1 cm – bare dimension 26.5 cm / 47.7 cm – bare dimension 38.1 cm  
 57.7 cm – bare dimension 48.1 cm / 63.2 cm – bare dimension 53.6 cm

▲ = Types also available with 63.2 cm carcass depth (order no. ... replace ... 58 ... with 63)

Order no.  
W H D

Hinge side:	Carcass depth	Decor groups								
		M10	M20	M30	M40	M50	M60	M70	M80	M90



**Dresser unit with roller shutter**  
**145.5 cm high 36,1 cm deep**  
 Roller shutter stainless steel decor  
 2 adjustable shelves  
 1 fixed shelf 52 cm from below  
 3 sockets

AJG	50	145	36	77		1070	-	-	-	2179	-	2505	-	-
AJG	60	145	36	77		1127	-	-	-	2327	-	2682	-	-
AJG	80	145	36	77		1246	-	-	-	2626	-	3039	-	-
AJG	90	145	36	77		1312	-	-	-	2783	-	3226	-	-

No visible sides possible in other decor groups

as above, but  
**Dresser unit with roller shutter**  
**145.5 cm high 47,7 cm deep**

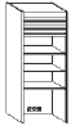
AJG	50	145	48	77		1103	-	-	-	2398	-	2794	-	-
AJG	60	145	48	77		1163	-	-	-	2566	-	2999	-	-
AJG	80	145	48	77		1285	-	-	-	2908	-	3411	-	-
AJG	90	145	48	77		1353	-	-	-	3085	-	3625	-	-

No visible sides possible in other decor groups

as above, but  
**Dresser unit with roller shutter**  
**145.5 cm high**

AJG	50	145	58	77	▲	1133	-	-	-	2586	-	3044	-	-
AJG	60	145	58	77	▲	1194	-	-	-	2773	-	3272	-	-
AJG	80	145	58	77	▲	1319	-	-	-	3149	-	3732	-	-
AJG	90	145	58	77	▲	1389	-	-	-	3345	-	3970	-	-

optional accessory:  
 only TAB-A\*\*45 can be used as a pull-out shelf, and only 577 mm deep  
 No visible sides possible in other decor groups



**Dresser unit with roller shutter**  
**145.5 cm high 36,1 cm deep**  
 Roller shutters black laminate  
 2 adjustable shelves  
 1 fixed shelf 52 cm from below  
 3 sockets

AJG	50	145	36	78		1133	-	-	-	2243	-	2568	-	-
AJG	60	145	36	78		1194	-	-	-	2393	-	2748	-	-
AJG	80	145	36	78		1320	-	-	-	2700	-	3113	-	-
AJG	90	145	36	78		1391	-	-	-	2862	-	3304	-	-

No visible sides possible in other decor groups

as above, but  
**Dresser unit with roller shutter**  
**145.5 cm high 47,7 cm deep**

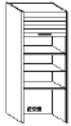
AJG	50	145	48	78		1167	-	-	-	2461	-	2858	-	-
AJG	60	145	48	78		1230	-	-	-	2633	-	3066	-	-
AJG	80	145	48	78		1359	-	-	-	2982	-	3485	-	-
AJG	90	145	48	78		1432	-	-	-	3164	-	3705	-	-

No visible sides possible in other decor groups

as above, but  
**Dresser unit with roller shutter**  
**145.5 cm high 57,7 cm deep**

AJG	50	145	58	78	▲	1197	-	-	-	2650	-	3108	-	-
AJG	60	145	58	78	▲	1260	-	-	-	2840	-	3339	-	-
AJG	80	145	58	78	▲	1393	-	-	-	3225	-	3806	-	-
AJG	90	145	58	78	▲	1467	-	-	-	3425	-	4049	-	-

optional accessory:  
 only TAB-A\*\*45 can be used as a pull-out shelf, and only 577 mm deep  
 No visible sides possible in other decor groups



**Dresser unit**  
**SMARTGLAS roller shutters**  
**145.5 cm high 36,1 cm deep**  
 2 adjustable shelves  
 1 fixed shelf 52 cm from below  
 3 sockets

AJSGG	60	145	36			2095	-	-	-	3294	-	3650	-	-
AJSGG	90	145	36			2333	-	-	-	3803	-	4246	-	-

Panel, guide profile and handle in the same colour as the roller shutter  
 No visible sides possible in other decor groups

as above, but  
**Dresser unit**  
**SMARTGLAS roller shutters**  
**145.5 cm high 47,7 cm deep**

AJSGG	60	145	48			2131	-	-	-	3534	-	3967	-	-
AJSGG	90	145	48			2373	-	-	-	4105	-	4646	-	-

as above, but  
**Dresser unit**  
**SMARTGLAS roller shutters**  
**145.5 cm high**

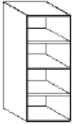
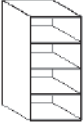
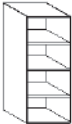
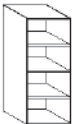

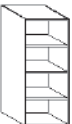
AJSGG	60	145	58		▲	2161	-	-	-	3741	-	4240	-	-
AJSGG	90	145	58		▲	2409	-	-	-	4366	-	4990	-	-

optional accessory:  
 only TAB-A\*\*45 can be used as a pull-out shelf, and only 577 mm deep  
 No visible sides possible in other decor groups

M 10	M 20	M 30	M 40	M 50
K M10 laminate				B M50 Velvet Lacquer S Microstructur lacquer
M 60	M 70	M 80	M 90	
	F M70 veneer / oak / walnut Z M70 Veneer / Bavaria			

# Dresser units Shelf units

Carcase depth 36.1 cm

		Decor groups													
		Order no. W H D			Hinge side:	Carcase depth	M10	M20	M30	M40	M50	M60	M70	M80	M90
	<b>Dresser shelf unit</b> <b>113 cm high</b> 3 adjustable shelves  wide in cm: 30 wide in cm: 40 wide in cm: 45 wide in cm: 50 wide in cm: 60	AR	30	11	36		215	-	-	-	806	-	806	806	-
		AR	40	11	36		215	-	-	-	806	-	806	806	-
		AR	45	11	36		215	-	-	-	806	-	806	806	-
		AR	50	11	36		215	-	-	-	806	-	806	806	-
		AR	60	11	36		215	-	-	-	806	-	806	806	-
	<b>Dresser shelf unit</b> <b>119.5 cm high</b> 3 adjustable shelves  wide in cm: 30 wide in cm: 40 wide in cm: 45 wide in cm: 50 wide in cm: 60	AR	30	119	36		215	-	-	-	826	-	826	826	-
		AR	40	119	36		215	-	-	-	826	-	826	826	-
		AR	45	119	36		215	-	-	-	826	-	826	826	-
		AR	50	119	36		215	-	-	-	826	-	826	826	-
		AR	60	119	36		215	-	-	-	826	-	826	826	-
	<b>Dresser shelf unit</b> <b>126 cm high</b> 3 adjustable shelves  wide in cm: 30 wide in cm: 40 wide in cm: 45 wide in cm: 50 wide in cm: 60	AR	30	12	36		215	-	-	-	846	-	846	846	-
		AR	40	12	36		215	-	-	-	846	-	846	846	-
		AR	45	12	36		215	-	-	-	846	-	846	846	-
		AR	50	12	36		215	-	-	-	846	-	846	846	-
		AR	60	12	36		215	-	-	-	846	-	846	846	-
	<b>Dresser shelf unit</b> <b>132.5 cm high</b> 3 adjustable shelves  wide in cm: 30 wide in cm: 40 wide in cm: 45 wide in cm: 50 wide in cm: 60	AR	30	132	36		215	-	-	-	865	-	865	865	-
		AR	40	132	36		215	-	-	-	865	-	865	865	-
		AR	45	132	36		215	-	-	-	865	-	865	865	-
		AR	50	132	36		215	-	-	-	865	-	865	865	-
		AR	60	132	36		215	-	-	-	865	-	865	865	-
	<b>Dresser shelf unit</b> <b>139 cm high</b> 3 adjustable shelves  wide in cm: 30 wide in cm: 40 wide in cm: 45 wide in cm: 50 wide in cm: 60	AR	30	13	36		215	-	-	-	887	-	887	887	-
		AR	40	13	36		215	-	-	-	887	-	887	887	-
		AR	45	13	36		215	-	-	-	887	-	887	887	-
		AR	50	13	36		215	-	-	-	887	-	887	887	-
		AR	60	13	36		215	-	-	-	887	-	887	887	-
	<b>Dresser shelf unit</b> <b>145.5 cm high</b> 3 adjustable shelves  wide in cm: 30 wide in cm: 40 wide in cm: 45 wide in cm: 50 wide in cm: 60	AR	30	145	36		226	-	-	-	926	-	926	926	-
		AR	40	145	36		226	-	-	-	926	-	926	926	-
		AR	45	145	36		226	-	-	-	926	-	926	926	-
		AR	50	145	36		226	-	-	-	926	-	926	926	-
		AR	60	145	36		226	-	-	-	926	-	926	926	-
<b>M 10</b>	<b>M 20</b>	<b>M 30</b>	<b>M 40</b>	<b>M 50</b>											
K M10 laminate				B M50 Velvet lacquer S M50 microstructure lacquer											
<b>M 60</b>	<b>M 70</b>	<b>M 80</b>	<b>M 90</b>												
	F M70 veneer / oak / walnut Z M70 Veneer / Bavaria	H M80 high gloss-Lacquer MP M80 laqué mat Premium													

## Dresser units Processing

	Order no.	Price
<b>Extra charge for unit with roller shutter for Height reduction up to 68 cm Extra charges for articles AJ.. and AJSG...</b>	<b>SA50HAJ</b>	72
<b>Reduction in carcass depth</b> 1. Available with drawer and pull-out for elements over 34 cm deep – use of standard drawer and pull-out depths. 2. Depth reductions for units with adjustable glass shelves are supplied with adjustable shelves in the carcass decor. 3. Depth reductions of carcasses with adjustable shelves – usable inside depth adapted to carcass depth depth reduction up to 30 cm	<b>SA50THJ</b>	276
<b>International socket Switzerland</b>	<b>ASD-CH</b>	119
<b>International socket Belgium</b>	<b>ASD-B</b>	70
<b>International socket France</b>	<b>ASD-F</b>	70
<b>International socket Great Britain</b>	<b>ASD-GB</b>	70



**1 built-in LED spotlight NOVA Eco**  
with cutout in wall unit top shelf,  
68 mm hole diameter  
External diameter of decorative ring 75 mm,  
24 power LEDs, 2.2 W,  
incl. connection lead 200 cm,  
Light colour: warm white 3000 K  
stainless steel-coloured

**Must be planned:**  
LED converter 30 W incl. 6-way distributor or LED converter 60 W incl. 6-way distributor **This product contains a light source of energy efficiency class F.**



**Important:**  
*Not available for country house wall unit models HGL...*  
*Cannot be combined with starter or add-on sets*

stainless steel-coloured  
black

<b>AFNEHO-1</b>	47
<b>AFNESHO-1</b>	47

**as above, but**  
2 built-in LED spotlights  
Available from unit width 50 cm

stainless steel-coloured  
black

<b>AFNEHO-2</b>	89
<b>AFNESHO-2</b>	89

**as above, but**  
3 built-in LED spotlights  
Available from unit width 80 cm

stainless steel-coloured  
black

<b>AFNEHO-3</b>	137
<b>AFNESHO-3</b>	137



**1 built-in LED spotlights Moonlight "Emotion"**  
**with cutout in wall unit top shelf,**  
LED Moonlight 68 Emotion, 3.6 W  
Homogeneous light, without visible light spots  
Installation depth of 12 mm  
Colours: stainless steel  
Installation diameter: Ø 68  
12 V DC incl. connection lead 200 cm  
Light Emotion: infinitely variable colour temperature, from warm white (2700 K) to cold white (6500 K), including dimming function  
**This product contains a light source of energy efficiency class F.**



**Important:**  
*Not available for country house wall unit models HGL...*  
**Must be planned:**  
*Starter set and, if necessary, add-on set*

stainless steel-coloured  
black

<b>AFMLHO-1</b>	93
<b>AFMLSHO-1</b>	93

**as above, but**  
**2 built-in LED spotlights Moonlight "Emotion"**  
**with cutout in wall unit top shelf,**  
Available from unit width 50 cm **This product contains a light source of energy efficiency class F.**



stainless steel-coloured  
black

<b>AFMLHO-2</b>	187
<b>AFMLSHO-2</b>	187


**as above, but**  
**3 built-in LED spotlights Moonlight "Emotion"**  
**with cutout in wall unit top shelf,**  
Available from unit width 80 cm  
**This product contains a light source of energy efficiency class F.**



stainless steel-coloured  
black

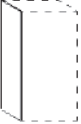
<b>AFMLHO-3</b>	279
<b>AFMLSHO-3</b>	279

## Dresser units Background filler

		Order no. W H D	Hinge side:	Carcase depth	Decor groups								
					M10	M20	M30	M40	M50	M60	M70	M80	M90
	<b>Dresser unit background filler 113 cm high</b> Width: 20 cm For fitting flush with carcase	<b>APSL 00 11</b>			22,80	24	62	82	82	82	82	82	-
	<b>Dresser unit background filler 119.5 cm high</b> Width: 20 cm For fitting flush with carcase	<b>APSL 00 119</b>			22,80	24	65	82	82	82	82	82	-
	<b>Dresser unit background filler 126 cm high</b> Width: 20 cm For fitting flush with carcase	<b>APSL 00 12</b>			22,80	24	67	89	89	89	89	89	-
	<b>Dresser unit background filler 132.5 cm high</b> Width: 20 cm For fitting flush with carcase	<b>APSL 00 132</b>			22,80	24,10	71	94	94	94	94	94	-
	<b>Dresser unit background filler 139 cm high</b> Width: 20 cm For fitting flush with carcase	<b>APSL 00 13</b>			22,80	24	75	100	100	100	100	100	-
	<b>Dresser unit background filler 145.5 cm high</b> Width: 20 cm For fitting flush with carcase	<b>APSL 00 145</b>			23,70	25,20	78	105	105	105	105	105	-
<b>M 10</b> K M10 laminate	<b>M 20</b> D M20 Laminate decor	<b>M 30</b> I M30 RESOPAL PRO super matt IH M30 HPL PRO PW M30 PRIMEWOOD/Basic Veneer	<b>M 40</b> A M40 DIRECTLACK matt L M40 DIRECTLACK high-gloss		<b>M 50</b> B M50 Velvet lacquer P M50 Soft lacquer S M50 microstructure lacquer								
<b>M 60</b> QH M60 SMARTGLAS high-gloss QM M60 SMARTGLAS satin-finish	<b>M 70</b> F M70 veneer / oak / walnut Z M70 Veneer / Bavaria	<b>M 80</b> C1 M80 FENIX stainless-steel look H M80 high gloss-Lacquer MP M80 laqué mat Premium	<b>M 90</b>										

## Dresser units Visible sides

Important! Installation instead of a normal unit side.

		Order no.	R/L	Hinge side:	Carcase depth	Decor groups								
						M10	M20	M30	M40	M50	M60	M70	M80	M90
	<b>Dresser unit visible side 113 cm high</b>	<b>ASV 11</b>				0	0	59	59	77	77	89	124	-
	<b>Dresser unit visible side 119.5 cm high</b>	<b>ASV 119</b>				0	0	63	63	83	83	95	130	-
	<b>Dresser unit visible side 126 cm high</b>	<b>ASV 12</b>				0	0	64	64	85	85	100	137	-
	<b>Dresser unit visible side 132.5 cm high</b>	<b>ASV 132</b>				0	0	66	66	87	87	107	141	-
	<b>Dresser unit visible side 139 cm high</b>	<b>ASV 13</b>				0	0	67	67	89	89	112	147	-
	<b>Dresser unit visible side 145.5 cm high</b>	<b>ASV 145</b>				0	0	70	70	93	93	117	157	-
<b>M 10</b> K M10 laminate	<b>M 20</b> D M20 Laminate decor	<b>M 30</b> I M30 RESOPAL PRO super matt IH M30 HPL PRO PW M30 PRIMEWOOD/Basic Veneer	<b>M 40</b> A M40 DIRECTLACK matt L M40 DIRECTLACK high-gloss		<b>M 50</b> B M50 Velvet lacquer P M50 Soft lacquer RH M50 Velvet lacquer wood texture RW M50 Velvet lacquer spackle effect S M50 microstructure lacquer									
<b>M 60</b> QH M60 SMARTGLAS high-gloss QM M60 SMARTGLAS satin-finish	<b>M 70</b> F M70 veneer / oak / walnut V M70 Velvet lacquer textured Z M70 Veneer / Bavaria	<b>M 80</b> C1 M80 FENIX stainless-steel look H M80 high gloss-Lacquer MP M80 laqué mat Premium O M80 Veneered	<b>M 90</b>											

# 5.8

## Sliding door solutions for wall units / dresser units

Sliding door elements, free-standing	XL 5.8.1
Sliding door system SlideLine M	XL 5.8.2
Sliding doors for wall units SlideLine M	XL 5.8.3
Accessories SlideLine M	XL 5.8.3
SlideLine M 2-rail in conjunction with wall shelf unit 39 cm high	XL 5.8.4
SlideLine M 2-rail in conjunction with wall shelf unit 52 cm high	XL 5.8.5
SlideLine M 2-rail in conjunction with wall shelf unit 65 cm high	XL 5.8.6
SlideLine M 2-rail in conjunction with wall shelf unit 78 cm high	XL 5.8.7
SlideLine M 2-rail in conjunction with wall shelf unit 91 cm high	XL 5.8.8
Sliding doors for SlideLine M 2-rail in front of wall shelf units	XL 5.8.9
Sliding doors for SlideLine M 2-rail	XL 5.8.9

### Legend:



This symbol indicates which models are available

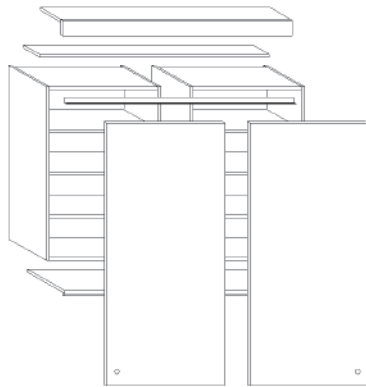


This symbol indicates which models are not available



Planning advice

# Sliding-door elements

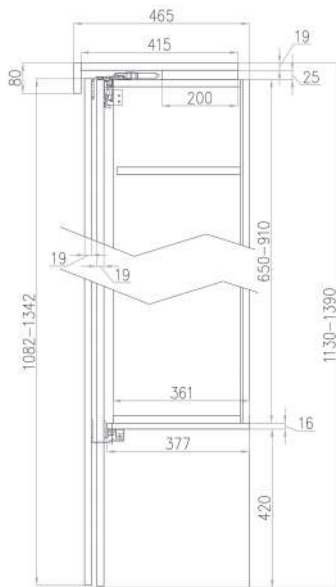


Sliding door elements can be presented and planned in different versions. This element is supplied complete with shelves, sliding doors, and accessories and consists of the following individual components:

- (1) Wall shelf units:  
e.g. for sliding door width 160 cm: 2x HR 80 78 36
- (2) Sliding doors in front material, supplied in pairs  
(e.g. width 160 cm: 2x sliding doors 81 cm wide).
- (3) The necessary slide rails (3) are supplied with the sliding doors.
- (4) The sliding door panel is included for cladding the slide rails.
- (5) 2 knobs K 081 are included in each delivery.

A top cover can also be optionally planned.

**Note:** Panels are **not** included in the delivery. For free-standing units, please order these separately (panel depth 47 cm).







Sliding doors for wall units

Sliding door elements		Shelf units		Sliding doors		Panel depth
Height	Width	Height	Width	Height	Width	
113 cm	120 cm	65 cm	2 x 60 cm	108.2 cm	2 x 61 cm	47 cm
	160 cm		2 x 80 cm		2 x 81 cm	47 cm
	180 cm		2 x 90 cm		2 x 91 cm	47 cm
126 cm	120 cm	78 cm	2 x 60 cm	121.2 cm	2 x 61 cm	47 cm
	160 cm		2 x 80 cm		2 x 81 cm	47 cm
	180 cm		2 x 90 cm		2 x 91 cm	47 cm
139 cm	120 cm	91 cm	2 x 60 cm	134.2 cm	2 x 61 cm	47 cm
	160 cm		2 x 80 cm		2 x 81 cm	47 cm
	180 cm		2 x 90 cm		2 x 91 cm	47 cm

Dimensions are based on a worktop thickness of 3.8 cm



# Sliding door elements, free-standing

		Order no. W H D	Hinge side: R/L	Carcass depth	Price groups															
					1	2	3	4	5	6	7	8	9							
 <p><b>Top unit for sliding door element, depth 46.5 cm height 113 cm</b> consisting of: 2 sliding doors of front material each with 1 knob K 081 2 shelf units from decor group K 1 sliding door corner panel 8 cm high, of front material 1 top shelf for compensation 25 mm 1 bottom shelf for lower rails 16 mm 2 guide rails</p>	<b>ASAF120 11</b> R/L 1196 1437 1783 2327 2383 2425 2967 3264 -	<b>ASAF160 11</b> R/L 1328 1648 2108 2828 2902 2961 3677 4045 -	<b>ASAF180 11</b> R/L 1349 1710 2226 3034 3116 3181 3987 4386 -	<p><b>Width 120, 160, 180 Not available for:</b> ALU TEC RP, ALUELEMENTS, ATLANTA-B, ATLANTA-S, BERGEN, CASTELLO, CHALET-B, CHALET-S, CHICAGO, FRAME, INTARSIA, LUGANO, LUX-B, MIAMI, NOBEL-B, NOBEL-S, ORLANDO-B, ORLANDO-S, OSLO 15, PALERMO-B, PALERMO-S, ROMA-B, ROMA-S, SOFIE-B, SOFIE-S, STRIP ELEMENTS, TALEA, TESSIN 15, TIM 15, VILLAGE 15-B, VILLAGE 15-S, VINO, VIVA, YORK-B, YORK-S</p> <p> <i>Version R = sliding door right front</i> <i>Version L = sliding door left front</i></p> <p><i>The front height is adjusted with variable worktop thicknesses for planning with connection to tall cabinets.</i></p> <p><b>The overall width of the sliding door elements is obtained by adding the panel thickness (e.g. sliding door element 120 cm, 2 panels 2.5 cm = overall width 125 cm)</b></p>																
	<b>ASAF120 12</b> R/L 1233 1477 1823 2366 2422 2466 3007 3308 -	<b>ASAF160 12</b> R/L 1439 1782 2272 3038 3119 3179 3943 4337 -	<b>ASAF180 12</b> R/L 1494 1877 2426 3287 3377 3446 4303 4733 -	<p><b>Width 120, 160, 180 Not available for:</b> ALU TEC RP, ALUELEMENTS, ATLANTA-B, ATLANTA-S, BERGEN, CASTELLO, CHALET-B, CHALET-S, CHICAGO, FRAME, INTARSIA, LUGANO, LUX-B, MIAMI, NOBEL-B, NOBEL-S, ORLANDO-B, ORLANDO-S, OSLO 15, PALERMO-B, PALERMO-S, ROMA-B, ROMA-S, SOFIE-B, SOFIE-S, STRIP ELEMENTS, TALEA, TESSIN 15, TIM 15, VILLAGE 15-B, VILLAGE 15-S, VINO, VIVA, YORK-B, YORK-S</p> <p> <i>Version R = sliding door right front</i> <i>Version L = sliding door left front</i></p>																
	<b>ASAF120 13</b> R/L 1253 1496 1841 2384 2440 2483 3025 3328 -	<b>ASAF160 13</b> R/L 1530 1900 2427 3257 3341 3408 4234 4657 -	<b>ASAF180 13</b> R/L 1588 2001 2595 3525 3621 3696 4623 5085 -	<p><b>Width 120, 160, 180 Not available for:</b> ALU TEC RP, ALUELEMENTS, ATLANTA-B, ATLANTA-S, BERGEN, CASTELLO, CHALET-B, CHALET-S, CHICAGO, FRAME, INTARSIA, LUGANO, LUX-B, MIAMI, NOBEL-B, NOBEL-S, ORLANDO-B, ORLANDO-S, OSLO 15, PALERMO-B, PALERMO-S, ROMA-B, ROMA-S, SOFIE-B, SOFIE-S, STRIP ELEMENTS, TALEA, TESSIN 15, TIM 15, VILLAGE 15-B, VILLAGE 15-S, VINO, VIVA, YORK-B, YORK-S</p> <p> <i>Version R = sliding door right front</i> <i>Version L = sliding door left front</i></p>																
<b>M 10</b>	<b>M 20</b>	<b>M 30</b>	<b>M 40</b>	<b>M 50</b>																
K M10 laminate																				
<b>M 60</b>	<b>M 70</b>	<b>M 80</b>	<b>M 90</b>																	

# Sliding door system SlideLine M



## Design in motion

SlideLine M upgrades the practical value and design of furniture:

wall, tall and base units in kitchen planning, and living room units made from the panel and shelf unit system.

### It's your ideas that decide.

With SlideLine M simple shelf units become appealing

functional furniture with looks that can be changed again and again.

Sliding the doors to different positions creates ever-changing constellations of open and closed elements. This gets things moving in your furniture design and never fails to please.

It's your ideas that decide.

Discover the wealth of applications for SlideLine M.

## Note:

Always use sliding door systems in isolation, because the fitting with front-flush shelves adds 33 mm, thus protruding beyond standard units.

## Base units:

Carcase widths:

45 cm, 50 cm, 60 cm, 80 cm, 90 cm

Carcase depths: 57.5 cm, 47.5 cm, 36.1 cm

Door widths: 45 cm, 50 cm, 60 cm, 80 cm, 90 cm

Door heights: 39 cm, 52 cm, 65 cm, 71.5 cm, 78 cm

## Wall units:

Carcase widths:

45 cm, 50 cm, 60 cm, 80 cm, 90 cm

Carcase depth: 36.1 cm

Door widths: 45 cm, 50 cm, 60 cm, 80 cm, 90 cm

Door heights: 39 cm, 52 cm, 65 cm, 78 cm, 91 cm

## Tall units:

Carcase widths:

30 cm, 40 cm, 45 cm, 50 cm, 60 cm

Carcase depths: 57.5 cm, 47.5 cm, 36.1 cm

Door widths: 90 cm

Door heights: 143 cm, 156 cm, 168.8 cm, 181.8 cm,

194.8 cm, 207.8 cm, 220.8 cm

**Important:** Because of fixed front width of 90 cm, the following carcass width combinations are possible (45/45 cm, 40/50 cm, 60/30 cm)

## Why SlideLine M?

Simple shelf units become appealing functional furniture with looks that can be changed again and again.

SlideLine M facilitates the playful interchange between open and closed sections.

The SlideLine M sliding door system ensures that no open doors are ever in the way, so do not create an obstruction in tight passages.

The smooth running action adds to the comfort, as does the cushioned closing of even heavy doors.

High-quality function and smart design, since the Silent System cushioning is integrated, out of sight, on the inside of the front.

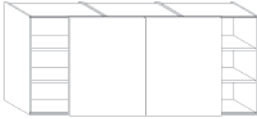
Even with several doors in one profile, they can still be cushioned to ensure blissful piece and quiet.














And because the end position of the doors can be chosen to suit,

the end customer has a high level of design freedom.

# Sliding doors for wall units SlideLine M

Design suggestion in conjunction with wall shelf unit  
 consisting of: 3 x HR 60 78 34  
 2 x SLHF 60 78  
 1 x SL-SET 19

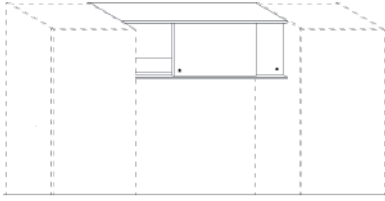


	Order no. W H D	Hinge side:	Carcass depth	Price groups								
				1	2	3	4	5	6	7	8	9
 <p><b>Sliding door for wall units height 39 cm</b> 38.6 cm high complete with fittings</p>	<b>SLHF 45 39</b>			223	246	278	324	329	332	383	421	-
	<b>SLHF 50 39</b>			227	252	287	339	345	351	407	448	-
	<b>SLHF 60 39</b>			233	262	306	369	375	379	446	491	-
	<b>SLHF 80 39</b>			246	285	342	427	438	444	535	589	-
	<b>SLHF 90 39</b>			252	297	361	458	469	478	578	636	-
 <p><b>Sliding door for wall units height 52 cm</b> 51.6 cm high complete with fittings</p>	<b>SLHF 45 52</b>			233	262	306	369	375	379	446	491	-
	<b>SLHF 50 52</b>			236	270	319	389	398	403	478	526	-
	<b>SLHF 60 52</b>			246	285	342	427	438	444	535	589	-
	<b>SLHF 80 52</b>			261	316	392	506	522	531	649	714	-
	<b>SLHF 90 52</b>			270	330	417	547	561	572	707	778	-
 <b>Width 45, 50, 60</b>  <b>Width 80, 90 Not available for: MIAMI, VIVA</b>												
 <p><b>Sliding door for wall units height 65 cm</b> 64.6 cm high complete with fittings</p>	<b>SLHF 45 65</b>			242	280	332	414	422	427	513	564	-
	<b>SLHF 50 65</b>			249	288	349	438	446	455	548	603	-
	<b>SLHF 60 65</b>			258	308	377	488	499	507	621	683	-
	<b>SLHF 80 65</b>			279	346	441	586	603	615	764	840	-
	<b>SLHF 90 65</b>			290	365	473	638	654	667	837	921	-
 <b>Width 45, 50, 60</b>  <b>Width 80, 90 Not available for: MIAMI, VIVA</b>												
 <p><b>Sliding door for wall units height 78 cm</b> 77.6 cm high complete with fittings</p>	<b>SLHF 45 78</b>			252	297	361	458	469	478	578	636	-
	<b>SLHF 50 78</b>			258	308	377	488	499	507	621	683	-
	<b>SLHF 60 78</b>			270	330	417	547	561	572	707	778	-
	<b>SLHF 80 78</b>			297	375	491	666	686	700	879	967	-
	<b>SLHF 90 78</b>			308	400	528	726	747	764	966	1063	-
 <b>Width 45, 50, 60</b>  <b>Width 80, 90 Not available for: ALUELEMENTS, ATLANTA-B, ATLANTA-S, BERGEN, CASTELLO, CHALET-B, CHALET-S, CHICAGO, FRAME, GENT, LUGANO, LUX-B, MIAMI, NOBEL-B, NOBEL-S, ORLANDO-B, ORLANDO-S, OSLO 15, PALERMO-B, PALERMO-S, ROMA-B, ROMA-S, SMART MIRROR, SOFIE-B, SOFIE-S, STRIP ELEMENTS, TESSIN 15, TIM 15, VILLAGE 15-B, VILLAGE 15-S, VINO, VIVA, YORK-B, YORK-S</b>												
 <p><b>Sliding door for wall units height 91 cm</b> 90.6 cm high complete with fittings</p>	<b>SLHF 45 91</b>			261	314	390	501	516	525	642	706	-
	<b>SLHF 50 91</b>			269	326	411	537	550	561	692	761	-
	<b>SLHF 60 91</b>			283	354	453	607	623	638	792	871	-
	<b>SLHF 80 91</b>			312	408	540	745	769	784	992	1091	-
	<b>SLHF 90 91</b>			326	432	583	815	841	859	1094	1203	-
 <b>Width 45, 50, 60</b>  <b>Width 80, 90 Not available for: ALUELEMENTS, ATLANTA-B, ATLANTA-S, BERGEN, CASTELLO, CHALET-B, CHALET-S, CHICAGO, FRAME, GENT, LUGANO, LUX-B, MIAMI, NOBEL-B, NOBEL-S, ORLANDO-B, ORLANDO-S, OSLO 15, PALERMO-B, PALERMO-S, ROMA-B, ROMA-S, SMART MIRROR, SOFIE-B, SOFIE-S, STRIP ELEMENTS, TESSIN 15, TIM 15, VILLAGE 15-B, VILLAGE 15-S, VINO, VIVA, YORK-B, YORK-S</b>												

## Accessories SlideLine M

 <p><b>Fittings for sliding doors profile set</b>  <b>For shelf thickness 19 mm</b>                      Complete with top and bottom runner profile (aluminium anodised) and ABS decor profile to be glued 300 cm long, to be shortened on-site                      Incl. end caps and assembly clips                      Fixing screws</p>	<b>SL-SET19</b>		181									
												

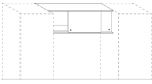
# SlideLine M 2-rail in conjunction with wall shelf unit 39 cm high



**Design suggestion in conjunction with wall shelf units**  
**Design suggestion in conjunction with:**  
 SL2 180 39  
**Planning advice:**  
 With free-hanging plans, 2 panels left and right are to be planned,  
 Dimensions for shelf height 39 cm:  
 height 42.2 cm, depth 40.1 cm  
 shelf depth 33.9 cm (depth of the slide rail 6.2 cm)

Order no.  
 W H D

Hinge side: Carcase depth	Price groups								
	1	2	3	4	5	6	7	8	9
SL2 120 39K	1085	1143	1230	1356	1371	1382	1513	1664	-
SL2 120 39S	1419	1478	1566	1691	1707	1715	1849	2034	-
SL2 120 39B	1419	1478	1566	1691	1707	1715	1849	2034	-
SL2 120 39H	1768	1827	1915	2041	2054	2064	2197	2417	-
SL2 120 39M	1768	1827	1915	2041	2054	2064	2197	2417	-
SL2 120 39F	1594	1650	1739	1866	1879	1889	2022	2224	-
SL2 120 39Z	1594	1650	1739	1866	1879	1889	2022	2224	-



**System 120 for wall shelf units**  
 between 2 tall units  
**2 shelf units**  
**W x H x D =60/39/33.9 cm**  
**from decor group K**  
 Profile set 2-rail SlideLine M  
 2 top covers 16 mm, width 120 cm  
 depth 40.1 cm  
 2 sliding doors width 60.6 cm, height 36.6 cm  
 complete with fittings  
 2 knobs K081  
 Profile set 2-rail SlideLine M  
 Front panels move offset to one another, thus the entire width can be closed completely.  
 Aluminium anodised  
**For use in conjunction with wall shelf units:**  
 for installation on top cover  
 2 profiles, 300 cm long, to be shortened on-site  
 Stopper for the sliding doors and fixing material  
 Height 8.3 mm, depth 62 mm

**Width 120 Not available for:** ALU TEC RP, ALUELEMENTS, ATLANTA-B, ATLANTA-S, BERGEN, CASTELLO, CHALET-B, CHALET-S, CHICAGO, FRAME, GENT, INTARSIA, LUGANO, LUX-B, MIAMI, NOBEL-B, NOBEL-S, ORLANDO-B, ORLANDO-S, OSLO 15, PALERMO-B, PALERMO-S, ROMA-B, ROMA-S, SMART MIRROR, SOFIE-B, SOFIE-S, STRIP ELEMENTS, TESSIN 15, TIM 15, VILLAGE 15-B, VILLAGE 15-S, VINO, VIVA, YORK-B, YORK-S

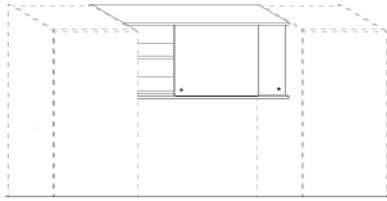


**System 180 for wall shelf units**  
 between 2 tall units  
**2 shelf units**  
**W x H x D =90/39/33.9 cm**  
**from decor group K**  
 Profile set 2-rail SlideLine M  
 2 top covers 16 mm, width 180 cm  
 depth 40.1 cm  
 2 sliding doors width 90.6 cm, height 36.6 cm  
 complete with fittings  
 2 knobs K081  
 Profile set 2-rail SlideLine M  
 Front panels move offset to one another, thus the entire width can be closed completely.  
 Aluminium anodised  
**For use in conjunction with wall shelf units:**  
 for installation on top cover  
 2 profiles, 300 cm long, to be shortened on-site  
 Stopper for the sliding doors and fixing material  
 Height 8.3 mm, depth 62 mm

**Width 180 Not available for:** ALU TEC RP, ALUELEMENTS, ATLANTA-B, ATLANTA-S, BERGEN, CASTELLO, CHALET-B, CHALET-S, CHICAGO, FRAME, GENT, INTARSIA, LUGANO, LUX-B, MIAMI, NOBEL-B, NOBEL-S, ORLANDO-B, ORLANDO-S, OSLO 15, PALERMO-B, PALERMO-S, ROMA-B, ROMA-S, SMART MIRROR, SOFIE-B, SOFIE-S, STRIP ELEMENTS, TESSIN 15, TIM 15, VILLAGE 15-B, VILLAGE 15-S, VINO, VIVA, YORK-B, YORK-S

M 10	M 20	M 30	M 40	M 50
K16 M10 Laminate				B16 M50 Velvet lacquer S16 M50 micro structured lacquer
M 60	M 70	M 80	M 90	
	F16 M70 veneer / oak 16 Z16 M70 Veneer / Bavaria	H16 M80 High gloss-Lacquer MP16 M80 Matt-Lacquer Premium		

# SlideLine M 2-rail in conjunction with wall shelf unit 52 cm high



Design suggestion in conjunction with wall shelf units

Design suggestion in conjunction with: SL2 180 52

Planning advice:



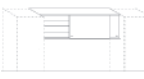

With free-hanging plans, 2 panels left and right are to be planned.

Dimensions for shelf height 52 cm:

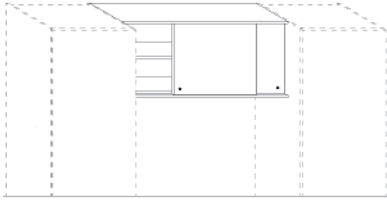
height 55.2 cm, depth 40.1 cm

shelf depth 33.9 cm (depth of the slide rails 6.2 cm)

## Price groups

Order no.	W	H	D	Hinge side:	Carcass depth	Price groups										
						1	2	3	4	5	6	7	8	9		
 <p><b>System 120 for wall shelf units</b> between 2 tall units <b>2 shelf units</b> <b>W x H x D =60/52/33.9 cm</b> <b>from decor group K</b> Profile set 2-rail SlideLine M 2 top covers 16 mm, width 120 cm depth 40.1 cm 2 sliding doors width 60.6 cm, height 49.6 cm complete with fittings 2 knobs K081 Profile set 2-rail SlideLine M Front panels move offset to one another, thus the entire width can be closed completely. Aluminium anodised <b>For use in conjunction with wall shelf units:</b> for installation on top cover 2 profiles, 300 cm long, to be shortened on-site Stopper for the sliding doors and fixing material Height 8.3 mm, depth 62 mm</p>						SL2 120 52K	1108	1187	1300	1472	1494	1506	1685	1854	-	
							SL2 120 52S	1442	1522	1636	1808	1827	1841	2021	2223	-
							SL2 120 52B	1442	1522	1636	1808	1827	1841	2021	2223	-
							SL2 120 52H	1790	1872	1985	2157	2175	2191	2369	2606	-
							SL2 120 52M	1790	1872	1985	2157	2175	2191	2369	2606	-
							SL2 120 52F	1617	1696	1809	1982	1999	2014	2194	2413	-
							SL2 120 52Z	1617	1696	1809	1982	1999	2014	2194	2413	-
						 <b>Width 120 Not available for:</b> ALU TEC RP, ALUELEMENTS, ATLANTA-B, ATLANTA-S, BERGEN, CASTELLO, CHALET-B, CHALET-S, CHICAGO, FRAME, GENT, INTARSIA, LUGANO, LUX-B, MIAMI, NOBEL-B, NOBEL-S, ORLANDO-B, ORLANDO-S, OSLO 15, PALERMO-B, PALERMO-S, ROMA-B, ROMA-S, SMART MIRROR, SOFIE-B, SOFIE-S, STRIP ELEMENTS, TESSIN 15, TIM 15, VILLAGE 15-B, VILLAGE 15-S, VINO, VIVA, YORK-B, YORK-S										
 <p><b>System 180 for wall shelf units</b> between 2 tall units <b>2 shelf units</b> <b>W x H x D =60/52/33.9 cm</b> <b>from decor group K</b> Profile set 2-rail SlideLine M 2 top covers 16 mm, width 180 cm depth 40.1 cm 2 sliding doors width 90.6 cm, height 49.6 cm complete with fittings 2 knobs K081 Profile set 2-rail SlideLine M Profile set 2-rail SlideLine M Front panels move offset to one another, thus the entire width can be closed completely. Aluminium anodised <b>For use in conjunction with wall shelf units:</b> for installation on top cover 2 profiles, 300 cm long, to be shortened on-site Stopper for the sliding doors and fixing material Height 8.3 mm, depth 62 mm</p>						SL2 180 52K	1284	1406	1577	1838	1869	1890	2159	2375	-	
							SL2 180 52S	1788	1911	2082	2343	2371	2395	2663	2929	-
							SL2 180 52B	1788	1911	2082	2343	2371	2395	2663	2929	-
							SL2 180 52H	2311	2431	2602	2864	2894	2914	3184	3502	-
							SL2 180 52M	2311	2431	2602	2864	2894	2914	3184	3502	-
							SL2 180 52F	2049	2170	2342	2602	2631	2654	2921	3213	-
							SL2 180 52Z	2049	2170	2342	2602	2631	2654	2921	3213	-
						 <b>Width 180 Not available for:</b> ALU TEC RP, ALUELEMENTS, ATLANTA-B, ATLANTA-S, BERGEN, CASTELLO, CHALET-B, CHALET-S, CHICAGO, FRAME, GENT, INTARSIA, LUGANO, LUX-B, MIAMI, NOBEL-B, NOBEL-S, ORLANDO-B, ORLANDO-S, OSLO 15, PALERMO-B, PALERMO-S, ROMA-B, ROMA-S, SMART MIRROR, SOFIE-B, SOFIE-S, STRIP ELEMENTS, TESSIN 15, TIM 15, VILLAGE 15-B, VILLAGE 15-S, VINO, VIVA, YORK-B, YORK-S										
<b>M 10</b>	<b>M 20</b>	<b>M 30</b>	<b>M 40</b>	<b>M 50</b>												
K16 M10 Laminate				B16 M50 Velvet lacquer S16 M50 micro structured lacquer												
<b>M 60</b>	<b>M 70</b>	<b>M 80</b>	<b>M 90</b>													
	F16 M70 veneer / oak 16 Z16 M70 Veneer / Bavaria	H16 M80 High gloss-Lacquer MP16 M80 Matt-Lacquer Premium														

# SlideLine M 2-rail in conjunction with wall shelf unit 65 cm high



Design suggestion in conjunction with wall shelf units

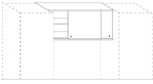
Design suggestion in conjunction with: SL2 180 65

Planning advice:

With free-hanging plans, 2 panels left and right are to be planned.  
Dimensions for shelf height 65 cm: height 68.2 cm, depth 40.1 cm shelf depth 33.9 cm (depth of the slide rail 6.2 cm)

Order no.  
W H D

Hinge side:	Carcase depth	Price groups								
		1	2	3	4	5	6	7	8	9
		1185	1287	1428	1644	1670	1685	1912	2103	-
		1520	1622	1762	1981	2003	2021	2246	2471	-
		1520	1622	1762	1981	2003	2021	2246	2471	-
		1869	1971	2110	2328	2353	2369	2595	2855	-
		1869	1971	2110	2328	2353	2369	2595	2855	-
		1692	1795	1935	2154	2176	2194	2418	2660	-
		1692	1795	1935	2154	2176	2194	2418	2660	-

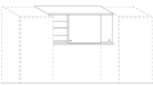


**System 120 for wall shelf units**  
between 2 tall units

**2 shelf units**  
W x H x D =60/65/33.9 cm  
from decor group K

Profile set 2-rail SlideLine M  
2 top covers 16 mm, width 120 cm depth 40.1 cm  
2 sliding doors width 60.6 cm, height 62.6 cm complete with fittings  
2 knobs K081  
Profile set 2-rail SlideLine M  
Front panels move offset to one another, thus the entire width can be closed completely.  
Aluminium anodised  
**For use in conjunction with wall shelf units:**  
for installation on top cover  
2 profiles, 300 cm long, to be shortened on-site  
Stopper for the sliding doors and fixing material  
Height 8.3 mm, depth 62 mm

**Width 120 Not available for:** ALU TEC RP, ALUELEMENTS, ATLANTA-B, ATLANTA-S, BERGEN, CASTELLO, CHALET-B, CHALET-S, CHICAGO, FRAME, GENT, INTARSIA, LUGANO, LUX-B, MIAMI, NOBEL-B, NOBEL-S, ORLANDO-B, ORLANDO-S, OSLO 15, PALERMO-B, PALERMO-S, ROMA-B, ROMA-S, SMART MIRROR, SOFIE-B, SOFIE-S, STRIP ELEMENTS, TESSIN 15, TIM 15, VILLAGE 15-B, VILLAGE 15-S, VINO, VIVA, YORK-B, YORK-S



**System 180 for wall shelf units**  
between 2 tall units

**2 shelf units**  
W x H x D =90/65/33.9 cm  
from decor group K

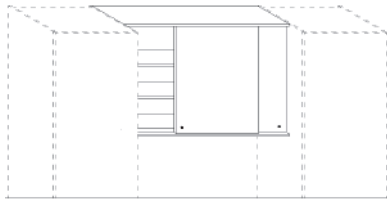
Profile set 2-rail SlideLine M  
2 top covers 16 mm, width 180 cm depth 40.1 cm  
2 sliding doors width 90.6 cm, height 62.6 cm complete with fittings  
2 knobs K081  
Profile set 2-rail SlideLine M  
Front panels move offset to one another, thus the entire width can be closed completely.  
Aluminium anodised  
**For use in conjunction with wall shelf units:**  
for installation on top cover  
2 profiles, 300 cm long, to be shortened on-site  
Stopper for the sliding doors and fixing material  
Height 8.3 mm, depth 62 mm

**Width 180 Not available for:** ALU TEC RP, ALUELEMENTS, ATLANTA-B, ATLANTA-S, BERGEN, CASTELLO, CHALET-B, CHALET-S, CHICAGO, FRAME, GENT, INTARSIA, LUGANO, LUX-B, MIAMI, NOBEL-B, NOBEL-S, ORLANDO-B, ORLANDO-S, OSLO 15, PALERMO-B, PALERMO-S, ROMA-B, ROMA-S, SMART MIRROR, SOFIE-B, SOFIE-S, STRIP ELEMENTS, TESSIN 15, TIM 15, VILLAGE 15-B, VILLAGE 15-S, VINO, VIVA, YORK-B, YORK-S

M 10	M 20	M 30	M 40	M 50
K16 M10 Laminate				B16 M50 Velvet lacquer S16 M50 micro structured lacquer
M 60	M 70	M 80	M 90	
	F16 M70 veneer / oak 16 Z16 M70 Veneer / Bavaria	H16 M80 High gloss-Lacquer MP16 M80 Matt-Lacquer Premium		

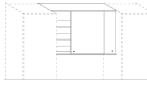


# SlideLine M 2-rail in conjunction with wall shelf unit 78 cm high




**Design suggestion in conjunction with wall shelf units**  
**Design suggestion in conjunction with: SL2 180 78**  
**Planning advice:**  
 With free-hanging plans, 2 panels left and right are to be planned.  
 Dimensions for shelf height 78 cm: height 81.2 cm, depth 40.1 cm shelf depth 33.9 cm (depth of the slide rail 6.2 cm)

		Price groups										
Order no.	W H D	Hinge side:	Carcass depth	1	2	3	4	5	6	7	8	9
				<b>SL2 120 78K</b>				1251	1371	1543	1805	1833
<b>SL2 120 78S</b>				1584	1707	1878	2138	2169	2191	2459	2705	-
<b>SL2 120 78B</b>				1584	1707	1878	2138	2169	2191	2459	2705	-
<b>SL2 120 78H</b>				1933	2054	2227	2487	2519	2539	2807	3088	-
<b>SL2 120 78M</b>				1933	2054	2227	2487	2519	2539	2807	3088	-
<b>SL2 120 78F</b>				1759	1879	2051	2313	2342	2364	2631	2894	-
<b>SL2 120 78Z</b>				1759	1879	2051	2313	2342	2364	2631	2894	-
Width 120 Not available for: ALU TEC RP, ALUELEMENTS, ATLANTA-B, ATLANTA-S, BERGEN, CASTELLO, CHALET-B, CHALET-S, CHICAGO, FRAME, GENT, INTARSIA, LUGANO, LUX-B, MIAMI, NOBEL-B, NOBEL-S, ORLANDO-B, ORLANDO-S, OSLO 15, PALERMO-B, PALERMO-S, ROMA-B, ROMA-S, SMART MIRROR, SOFIE-B, SOFIE-S, STRIP ELEMENTS, TESSIN 15, TIM 15, VILLAGE 15-B, VILLAGE 15-S, VINO, VIVA, YORK-B, YORK-S												



**System 120 for wall shelf units**  
 between 2 tall units  
**2 shelf units**  
**W x H x D =60/78/33.9 cm**  
**from decor group K**  
 Profile set 2-rail SlideLine M  
 2 top covers 16 mm, width 120 cm depth 40.1 cm  
 2 sliding doors width 60.6 cm, height 75.6 cm complete with fittings  
 2 knobs K081  
 Profile set 2-rail SlideLine M  
 Front panels move offset to one another, thus the entire width can be closed completely.  
 Aluminium anodised  
**For use in conjunction with wall shelf units:**  
 for installation on top cover  
 2 profiles, 300 cm long, to be shortened on-site  
 Stopper for the sliding doors and fixing material  
 Height 8.3 mm, depth 62 mm

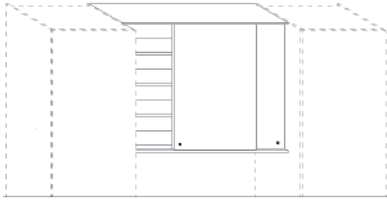


**System 180 for wall shelf units**  
 between 2 tall units  
**2 shelf units**  
**W x H x D =90/78/33.9 cm**  
**from decor group K**  
 Profile set 2-rail SlideLine M  
 2 top covers 16 mm, width 180 cm depth 40.1 cm  
 2 sliding doors width 90.6 cm, height 75.6 cm complete with fittings  
 2 knobs K081  
 Profile set 2-rail SlideLine M  
 Front panels move offset to one another, thus the entire width can be closed completely.  
 Aluminium anodised  
**For use in conjunction with wall shelf units:**  
 for installation on top cover  
 2 profiles, 300 cm long, to be shortened on-site  
 Stopper for the sliding doors and fixing material  
 Height 8.3 mm, depth 62 mm

M 10	M 20	M 30	M 40	M 50
K16 M10 Laminate				B16 M50 Velvet lacquer S16 M50 micro structured lacquer
M 60	M 70	M 80	M 90	
	F16 M70 veneer / oak 16 Z16 M70 Veneer / Bavaria	H16 M80 High gloss-Lacquer MP16 M80 Matt-Lacquer Premium		



# SlideLine M 2-rail in conjunction with wall shelf unit 91 cm high



**Design suggestion in conjunction with wall shelf units**

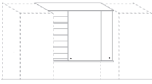
**Design suggestion in conjunction with:**  
SL2 180 91

**Planning advice:**

With free-hanging plans, 2 panels left and right are to be planned,  
Dimensions for shelf height 91 cm:  
height 94.2 cm, depth 40.1 cm  
shelf depth 33.9 cm (depth of the slide rail 6.2 cm)

Order no.  
W H D

Hinge side:	Carcase depth	Price groups								
		1	2	3	4	5	6	7	8	9
		1291	1432	1632	1941	1972	1997	2311	2542	-
		1612	1753	1953	2260	2292	2318	2630	2893	-
		1612	1753	1953	2260	2292	2318	2630	2893	-
		1960	2101	2301	2610	2640	2667	2979	3277	-
		1960	2101	2301	2610	2640	2667	2979	3277	-
		1784	1925	2126	2433	2466	2491	2804	3084	-
		1784	1925	2126	2433	2466	2491	2804	3084	-



**System 120 for wall shelf units**  
between 2 tall units

**2 shelf units**  
**W x H x D =60/91/33.9 cm**  
**from decor group K**

Profile set 2-rail SlideLine M  
2 top covers 16 mm, width 120 cm  
depth 40.1 cm

2 sliding doors width 60.6 cm, height 88.6 cm  
complete with fittings  
2 knobs K081

Profile set 2-rail SlideLine M  
Front panels move offset to one another, thus the  
entire width can be closed completely.  
Aluminium anodised

**For use in conjunction with wall shelf units:**  
for installation on top cover  
2 profiles, 300 cm long, to be shortened on-site  
Stopper for the sliding doors and fixing material  
Height 8.3 mm, depth 62 mm

**Width 120 Not available for:** ALU TEC RP, ALUELEMENTS, ATLANTA-B, ATLANTA-S, BERGEN, CASTELLO, CHALET-B, CHALET-S, CHICAGO, FRAME, GENT, INTARSIA, LUGANO, LUX-B, MIAMI, NOBEL-B, NOBEL-S, ORLANDO-B, ORLANDO-S, OSLO 15, PALERMO-B, PALERMO-S, ROMA-B, ROMA-S, SMART MIRROR, SOFIE-B, SOFIE-S, STRIP ELEMENTS, TESSIN 15, TIM 15, VILLAGE 15-B, VILLAGE 15-S, VINO, VIVA, YORK-B, YORK-S



**System 180 for wall shelf units**  
between 2 tall units

**2 shelf units**  
**W x H x D =90/91/33.9 cm**  
**from decor group K**

Profile set 2-rail SlideLine M  
2 top covers 16 mm, width 180 cm  
depth 40.1 cm

2 sliding doors width 90.6 cm, height 88.6 cm  
complete with fittings  
2 knobs K081

Profile set 2-rail SlideLine M  
Front panels move offset to one another, thus the  
entire width can be closed completely.  
Aluminium anodised






**For use in conjunction with wall shelf units:**  
for installation on top cover  
2 profiles, 300 cm long, to be shortened on-site  
Stopper for the sliding doors and fixing material  
Height 8.3 mm, depth 62 mm

**Width 180 Not available for:** ALU TEC RP, ALUELEMENTS, ATLANTA-B, ATLANTA-S, BERGEN, CASTELLO, CHALET-B, CHALET-S, CHICAGO, FRAME, GENT, INTARSIA, LUGANO, LUX-B, MIAMI, NOBEL-B, NOBEL-S, ORLANDO-B, ORLANDO-S, OSLO 15, PALERMO-B, PALERMO-S, ROMA-B, ROMA-S, SMART MIRROR, SOFIE-B, SOFIE-S, STRIP ELEMENTS, TESSIN 15, TIM 15, VILLAGE 15-B, VILLAGE 15-S, VINO, VIVA, YORK-B, YORK-S

M 10	M 20	M 30	M 40	M 50
K16 M10 Laminate				B16 M50 Velvet lacquer S16 M50 micro structured lacquer
M 60	M 70	M 80	M 90	
	F16 M70 veneer / oak 16 Z16 M70 Veneer / Bavaria	H16 M80 High gloss-Lacquer MP16 M80 Matt-Lacquer Premium		

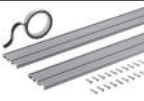
## Sliding doors for SlideLine M 2-rail in front of wall shelf units

For deviating configurations

	Order no. W H D	Hinge side: Carcase depth	Price groups								
			1	2	3	4	5	6	7	8	9
 <p><b>Wall unit sliding doors for profile set 2-rail</b> Suitable for carcase height 39 cm complete with fittings Front dimensions (W x H) with</p> <p>60 cm = 60.6 cm x 36.6 cm 80 cm = 80.6 cm x 36.6 cm 90 cm = 90.6 cm x 36.6 cm</p>			Width 60, 80, 90 Not available for: ALU TEC RP, INTARSIA, MIAMI, VIVA								
	<b>SLHF 60 391</b>		233	262	306	369	375	379	446	491	-
	<b>SLHF 80 391</b>		246	285	342	427	438	444	535	589	-
	<b>SLHF 90 391</b>		252	297	361	458	469	478	578	636	-
 <p><b>Wall unit sliding doors for profile set 2-rail</b> Suitable for carcase height 52 cm complete with fittings Front dimensions (W x H) with</p> <p>60 cm = 60.6 cm x 49.6 cm 80 cm = 80.6 cm x 49.6 cm 90 cm = 90.6 cm x 49.6 cm</p>			Width 60, 80, 90 Not available for: ALU TEC RP, INTARSIA, MIAMI, VIVA								
	<b>SLHF 60 521</b>		246	285	342	427	438	444	535	589	-
	<b>SLHF 80 521</b>		261	316	392	506	522	531	649	714	-
	<b>SLHF 90 521</b>		270	330	417	547	561	572	707	778	-
 <p><b>Wall unit sliding doors for profile set 2-rail</b> Suitable for carcase height 65 cm complete with fittings Front dimensions (W x H) with</p> <p>60 cm = 60.6 cm x 62.6 cm 80 cm = 80.6 cm x 62.6 cm 90 cm = 90.6 cm x 62.6 cm</p>			Width 60, 80, 90 Not available for: ALU TEC RP, INTARSIA, MIAMI, VIVA								
	<b>SLHF 60 651</b>		258	308	377	488	499	507	621	683	-
	<b>SLHF 80 651</b>		279	346	441	586	603	615	764	840	-
	<b>SLHF 90 651</b>		290	365	473	638	654	667	837	921	-
 <p><b>Wall unit sliding doors for profile set 2-rail</b> Suitable for carcase height 78 cm complete with fittings Front dimensions (W x H) with</p> <p>60 cm = 60.6 cm x 75.6 cm 80 cm = 80.6 cm x 75.6 cm 90 cm = 90.6 cm x 75.6 cm</p>			Width 60 Not available for: ALU TEC RP, INTARSIA, MIAMI, VIVA Width 80, 90 Not available for: ALU TEC RP, ALUELEMENTS, ATLANTA-B, ATLANTA-S, BERGEN, CASTELLO, CHALET-B, CHALET-S, CHICAGO, FRAME, GENT, INTARSIA, LUGANO, LUX-B, MIAMI, NOBEL-B, NOBEL-S, ORLANDO-B, ORLANDO-S, OSLO 15, PALERMO-B, PALERMO-S, ROMA-B, ROMA-S, SMART MIRROR, SOFIE-B, SOFIE-S, STRIP ELEMENTS, TESSIN 15, TIM 15, VILLAGE 15-B, VILLAGE 15-S, VINO, VIVA, YORK-B, YORK-S								
	<b>SLHF 60 781</b>		270	330	417	547	561	572	707	778	-
	<b>SLHF 80 781</b>		297	375	491	666	686	700	879	967	-
	<b>SLHF 90 781</b>		308	400	528	726	747	764	966	1063	-
 <p><b>Wall unit sliding doors for profile set 2-rail</b> Suitable for carcase height 91 cm complete with fittings Front dimensions (W x H) with</p> <p>60 cm = 60.6 cm x 88.6 cm 80 cm = 80.6 cm x 88.6 cm 90 cm = 90.6 cm x 88.6 cm</p>			Width 60 Not available for: ALU TEC RP, INTARSIA, MIAMI, VIVA Width 80, 90 Not available for: ALU TEC RP, ALUELEMENTS, ATLANTA-B, ATLANTA-S, BERGEN, CASTELLO, CHALET-B, CHALET-S, CHICAGO, FRAME, GENT, INTARSIA, LUGANO, LUX-B, MIAMI, NOBEL-B, NOBEL-S, ORLANDO-B, ORLANDO-S, OSLO 15, PALERMO-B, PALERMO-S, ROMA-B, ROMA-S, SMART MIRROR, SOFIE-B, SOFIE-S, STRIP ELEMENTS, TESSIN 15, TIM 15, VILLAGE 15-B, VILLAGE 15-S, VINO, VIVA, YORK-B, YORK-S								
	<b>SLHF 60 911</b>		283	354	453	607	623	638	792	871	-
	<b>SLHF 80 911</b>		312	408	540	745	769	784	992	1091	-
	<b>SLHF 90 911</b>		326	432	583	815	841	859	1094	1203	-

## Sliding doors for SlideLine M 2-rail

For deviating configurations

 <p><b>Sliding door system profile set 2-rail Slide-Line M</b> Front panels move offset to one another, thus the entire width can be closed completely. Aluminium anodised For use on wall shelf units and apertures For gluing and screwing 2 profiles, 300 cm long, to be shortened on-site Stopper for the sliding doors and fixing material Height 8.3 mm, depth 62 mm For deviating configurations</p>	<b>SL2-SET</b>		233								



# 6

## Tall units

Height 143 cm

Height 156 cm

Height 168,8 cm

Height 181.8 cm

Height 194.8 cm

Height 207.8 cm

Height 220.8 cm

Height 233.8 / 246.8 / 259.8 cm

Dresser units for tall units

Sliding door solutions for tall units

### Legend:



71.5 cm line



78 cm line



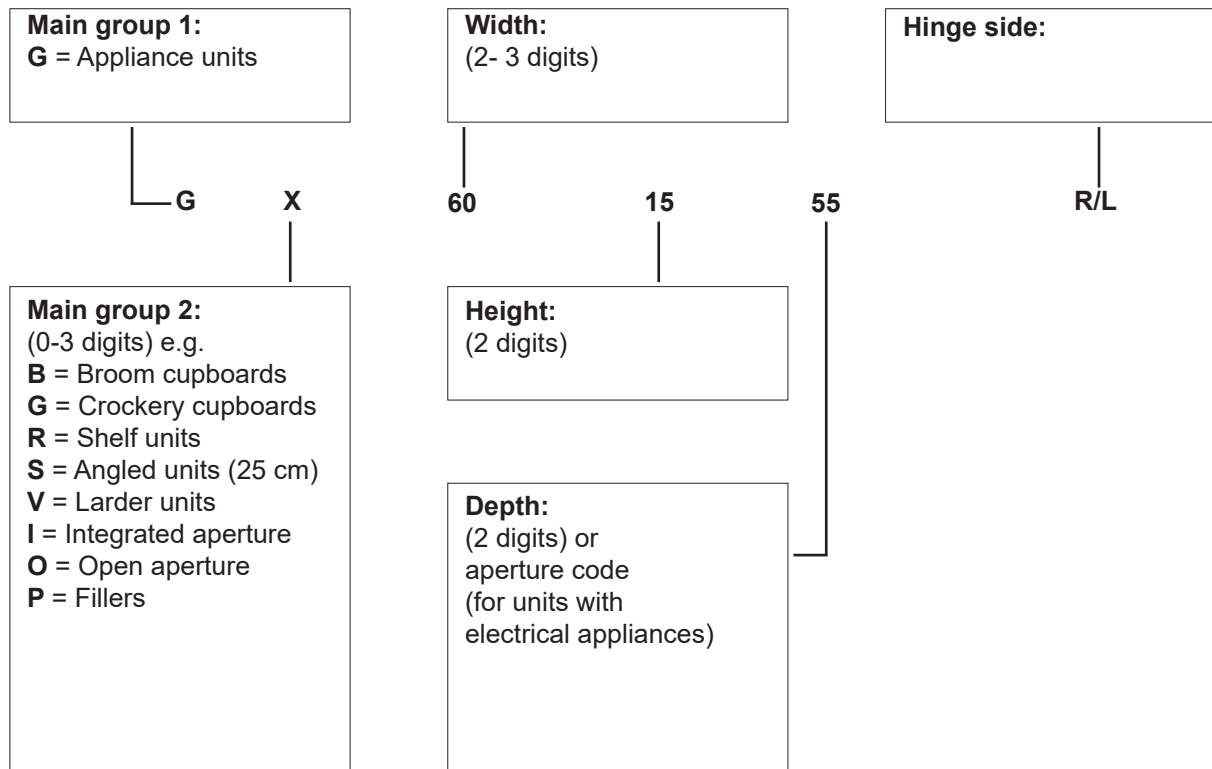
84.5 cm line



This symbol shows optimised gap widths for open appliance recesses (optiSPACE)

# Technical information - Tall units

## Explanation of order number



### Product advantages:

- Metal interior fittings with galvanised brilliant **chrome plating**
- **High-quality appearance through uniform gap alignment**
- **No** extra charge for carcass depth 45.5 cm and 34 cm
- Larder units with **pull-out cushioning**
- All front divisions available via the modular system

# Hanging tall units

## Planning advice

### A kitchen designed for all tastes

Base units and tall units without plinth appear to float in the room, giving the room a touch of light modernity. To this end, we offer base units in the carcass heights

39 cm (3 grids),  
52 cm (4 grids) and  
65 cm (5 grids)

and tall units (crockery cupboards) in the carcass heights

143 cm (11 grids),  
156 cm (12 grids),  
168.8 cm (13 grids),  
181.8 cm (14 grids) and  
194.8 cm (15 grids),

to be mounted on the wall.

Planning options range from a completely free-hanging line of base units to a corner combination with connection to floor-mounted base units.

The available base units and tall units are prepared for wall mounting at the factory.

One heavy-duty fitting complete with cap is fitted in the right and left-hand carcass sides.

## Legend



### Wall-mounted tall units

**2 sets of heavy-duty fittings** are installed in the case of tall units. All indicated cabinet types are approved for mounting on the wall without plinth.

Carcass depths: 34 cm, 45.5 cm and 55.5 cm

Extra charge for heavy-load fittings for wall-hanging tall units incl. screw-on plinth blocks MP-WST2

### Wall-mounting hardware must be provided by the customer!

The units must be mounted directly on the wall. Suitable hardware (screws and raw plugs) for mounting the units on the wall must be decided upon and procured by the customer.



### Assembly instructions:

The fittings are installed in the carcass sides and may not be changed. They may only be installed by authorised persons. Robust attachment requires a wall of suitable load-bearing capacity. Wall-mounting hardware is not included in the scope of delivery and must therefore be obtained by the customer.

The load-bearing capacity and nature of the wall, as well as the precise type of attachment must always be decided on site by a structural engineer or correspondingly authorized person. We cannot accept any liability for property damage or personal injury due to improper installation or inadequate building strength.

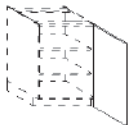
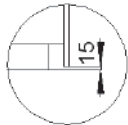


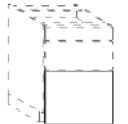
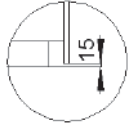


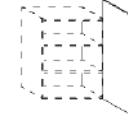
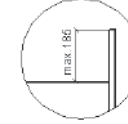




# Special finish Tall units

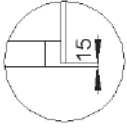
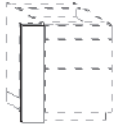
		Order no.	Price		
<b>Reduction in carcass width</b> Tall units, tall shelf units		Tall units, tall shelf units	SA50 BS	131	
<b>Variable width of drawers/pull-outs</b> Price calculation: Article SA50BU must be taken into account. Extra charge refers to next largest element.		 Not available for: all handles N..., base units with connected panels, design fronts G1, G2, G2S, G5S, G6	Extra charge for width reduction 1 drawer of 31-119 cm Extra charge for width reduction 1 pull-out of 31-119 cm	SA50BSK SA50BAZ	48 57
<b>Reduction in carcass depth</b> 1. Available with drawer and pull-out for elements over 34 cm deep – use of standard drawer and pull-out depths. 2. Depth reductions for units with adjustable glass shelves are supplied with adjustable shelves in the carcass decor. 3. Depth reductions of carcasses with adjustable shelves – usable inside depth adapted to carcass depth		Tall units, tall shelf units	SA50 TSI	145	
<b>Reduction in carcass height</b> Available for all grid height dimensions (drawers/doors). Other dimensions only on consultation.		Tall units, tall shelf units	SA50 HS	131	
<b>Cutout in rear carcass area</b> 1. Only possible for tall units where no drawers/pull-outs are planned!		Tall units, tall shelf units	SA50AKS	169	
<b>Function change behind the front</b> <b>Integrated aperture with full back panel and adjustable shelves</b> for planning a combination of appliance tall units for fridge/freezer combinations and crockery cupboard with the same front partition In combination with the item number TX..., the appliance tall unit is equipped with a continuous back panel and adjustable shelves.		suitable for door height 64.6 cm with 2 adjustable shelves suitable for door height 77.6 cm with 2 adjustable shelves suitable for door height 90.6 cm with 3 adjustable shelves suitable for door height 103.6 cm with 3 adjustable shelves suitable for door height 116.6 cm with 3 adjustable shelves suitable for door height 129.6 cm with 3 adjustable shelves suitable for door height 142.6 cm with 4 adjustable shelves suitable for door height 194.6 cm with 5 adjustable shelves	TX060655.NIRE2 TX060785.NIRE2 TX060915.NIRE3 TX0601045.NIRE3 TX0601175.NIRE3 TX0601305.NIRE3 TX0601435.NIRE4 TX060195.NIRE5	46 46 53 53 53 53 64 72	
<b>Function change behind the front</b> In principle, no change to the front division. When changing the front division, please take the module system into consideration. For processing, see examples!		 A height width reduction is not possible for the following models: MIAMI, VIVA			
<b>All listed extra charge positions apply as the basis for calculation and will be included in the total cost of the cabinet.</b>  <b>No installation of additional fronts.</b> <b>Further special finishes only possible via tall unit module system!</b>		Replacement drawer instead of pull-out Change drawer- or pull-out depth up to max. 45.5 / 35 cm <b>Installation</b> of functions (e.g. internal pull-out)* *Function elements are calculated Dowelling fronts Replacement flap door instead of hinged door Replacement pull-out table instead of drawer	TX05013.BF TX050263.AR TX00263.AR TX080263.AR TX010263.AR TX070263.AR	0 0 0 46 42 314	
<b>Extra charge for heavy-duty fittings wall-mounted units</b>			MP-WST2	228	
<b>Extra charge for Drawer/pull-out LEGRABOX WOOD</b>			MP-WOOD	170	



# Front extension Tall units

		Order no. W H D	Hinge side: Carcass depth	Price groups								
				1	2	3	4	5	6	7	8	9
 <p><b>Extra charge front extension</b> For doors of tall units extended up to 1.5 cm above floor (1.5 cm less than plinth height) Please note that twice the quantity is needed for 2-door units</p> 	<b>FV 30</b>	46	49	51	72	98	100	109	120	-		
	<b>FV 40</b>	49	50	52	76	105	112	121	133	-		
	<b>FV 45</b>	50	51	53	78	109	114	123	135	-		
	<b>FV 50</b>	51	52	54	83	113	120	131	144	-		
	<b>FV 60</b>	53	54	59	87	118	133	144	158	-		
	<b>FV70</b>	66	68	74	109	148	166	180	198	-		
	<b>FV75</b>	66	68	74	109	148	166	180	198	-		
	<b>FV80</b>	66	68	74	109	148	166	180	198	-		
	 <b>Not available for:</b> MIAMI, VIVA											
	 <i>Tall units with glass doors, corner units, diagonal units, angled units and tall appliance units with integrated ventilation are not available with front extension.</i>											
 <p><b>Extra charge front extension</b> for pull-outs Available for pull-out heights: 25.6 cm, 32.1 cm, 38.6 cm, 45.1, 51.6 cm extended up to 1.5 cm above floor (1.5 cm less than plinth height)</p> 	<b>FVA 30</b>	105	109	111	131	158	160	166	183	-		
	<b>FVA 40</b>	112	113	116	140	166	173	183	201	-		
	<b>FVA 45</b>	116	117	119	145	172	179	190	209	-		
	<b>FVA 50</b>	119	120	122	149	180	188	200	220	-		
	<b>FVA 60</b>	122	123	128	157	187	202	213	234	-		
	<b>FVA 70</b>	136	140	144	178	210	220	233	256	-		
	<b>FVA 80</b>	136	140	144	178	210	220	233	256	-		
	<b>FVA 90</b>	144	149	155	188	222	240	257	283	-		
	<b>FVA 100</b>	153	160	164	199	232	260	276	304	-		
	<b>FVA 120</b>	167	181	187	223	259	298	317	349	-		
 <b>Not available for:</b> MIAMI, VIVA												
 <b>Important!</b> <i>Base units with glass doors, corner units, diagonal units, angled units are not available with front extension.</i>												
<i>Tall units with glass doors, corner units, diagonal units, angled units and tall appliance units with integrated ventilation are not available with front extension.</i> <i>Pinned fronts cannot be extended</i>												
 <p><b>Extra charge front extension for upper door of tall units</b> not possible for connected doors can be extended upwards by maximum 18.5 cm</p> 	<b>FVGO 30</b>	46	49	51	72	98	100	109	120	-		
	<b>FVGO 40</b>	49	50	52	76	105	112	121	133	-		
	<b>FVGO 45</b>	50	51	53	78	109	114	123	135	-		
	<b>FVGO 50</b>	51	52	54	83	113	120	131	144	-		
	<b>FVGO 60</b>	53	54	59	87	118	133	144	158	-		
	 <b>Not available for:</b> MIAMI, VIVA											
 <i>Tall units with glass doors, corner units, diagonal units, angled units and tall appliance units with integrated ventilation are not available with front extension.</i> <i>The front will be delivered as a separate package.</i>												

# Front extension Tall units



**Tall unit front filler with front extension**  
 3.5 - 10 cm  
 11 - 20 cm  
 extended up to 1.5 cm above floor  
 (1.5 cm less than plinth height)

Order no.  
 W H D

Hinge side:	Carcase depth	Price groups									
		1	2	3	4	5	6	7	8	9	
		<b>GPFV 10 14</b>	128	131	141	214	239	242	258	284	-
		<b>GPFV 20 14</b>	136	139	156	240	267	269	287	316	-
		Not available for: MIAMI, VIVA									
		<b>GPFV 10 15</b>	129	133	144	216	242	245	263	289	-
		<b>GPFV 20 15</b>	138	141	157	244	269	271	290	319	-
		Not available for: MIAMI, VIVA									
		<b>GPFV 10 16</b>	129	133	144	216	242	245	263	289	-
		<b>GPFV 20 16</b>	138	141	157	244	269	271	290	319	-
		Not available for: MIAMI, VIVA									
		<b>GPFV 10 18</b>	129	133	144	216	242	245	263	289	-
		<b>GPFV 20 18</b>	138	141	157	244	269	271	290	319	-
		Not available for: MIAMI, VIVA									
		<b>GPFV 10 19</b>	129	133	144	216	242	245	263	289	-
		<b>GPFV 20 19</b>	138	141	157	244	269	271	290	319	-
		Not available for: MIAMI, VIVA									
		Note: Models with horizontally running graining can only be supplied with 2-part front trim panel.									
		<b>GPFV 10 20</b>	145	148	160	233	259	261	279	307	-
		<b>GPFV 20 20</b>	155	158	170	255	281	283	307	338	-
		Not available for: MIAMI, VIVA									
		Note: Models with horizontally running graining can only be supplied with 2-part front trim panel.									
		<b>GPFV 10 22</b>	145	148	160	233	259	261	279	307	-
		<b>GPFV 20 22</b>	155	158	170	255	281	283	307	338	-
		Not available for: MIAMI, VIVA									
		Note: Models with horizontally running graining can only be supplied with 2-part front trim panel.									

**Tall unit front filler with front extension**

**Tall unit front filler with front extension**

**Tall unit front filler with front extension**

**Tall unit front filler with front extension**  
 3.5 - 10 cm  
 11 - 20 cm  
 extended up to 1.5 cm above floor  
 (1.5 cm less than plinth height)

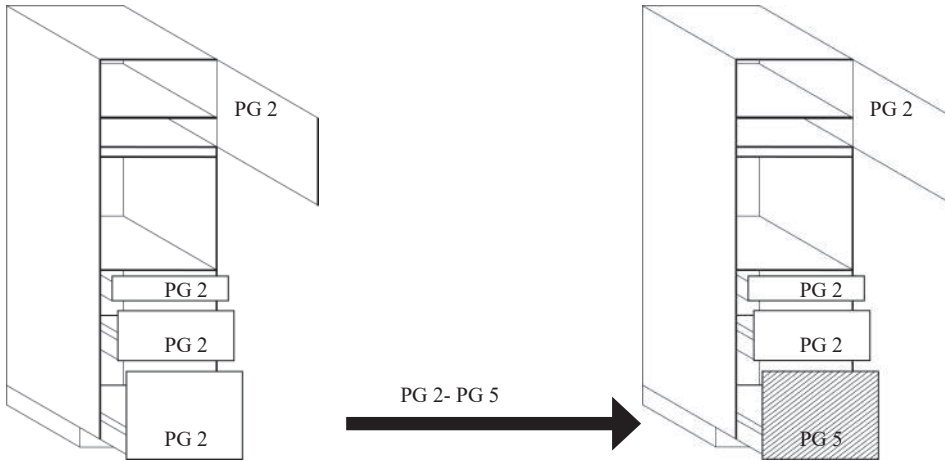
**Tall unit front filler with front extension**  
 3.5 - 10 cm  
 11 - 20 cm  
 extended up to 1.5 cm above floor  
 (1.5 cm less than plinth height)

**Tall unit front filler with front extension**  
 3.5 - 10 cm  
 11 - 20 cm  
 extended up to 1.5 cm above floor  
 (1.5 cm less than plinth height)

# Special finish

Order no.  
W H D

Hinge side: Carcass depth	Price groups								
	1	2	3	4	5	6	7	8	9



The new Flex Design enables you to exchange individual fronts within a unit type for fronts from a different model - regardless of whether it is from the same or a different price group, regardless of whether it is a door, pull-out or flap door.

Note: In the case of connected fronts and special elements, an exchange is not always possible. Specific cases will be clarified upon request

Planning and calculation example:

Model:

XL/GL 2641 PUR DIRECTLACK black matt

Unit type:

Appliance tall unit GO 60 19 20 X3

Wish:

Pull-out front bottom 38.6 cm exchanged for Model XL/GL MALMÖ 5924 oak veneer Urban Oak

Dimensions of the front in qm:

(W x H) 59.6 cm x 38.6 cm = 0.23 qm

Extra charge from price group 2 to price

group 5:

Article XL: MP-FLDXL-2 0.23 qm x 408.00 €/qm = €94.00

Article GL: MP-FLDGL-2 0.23 qm x 408.00 €/qm = €94.00

Extra charge: €94.00

Note: Exchanges to a lower price group will not result in a reimbursement of the price difference.

The deliverability of the replacement front and the availability of the handle versions must be checked in advance.

### Front substitution

Front substitution from PG.1 to PG.8

Front substitution from PG.2 to PG.8

Front substitution from PG.3 to PG.8

Front substitution from PG.4 to PG.8

Front substitution from PG.5 to PG.8

Front substitution from PG.6 to PG.8

Front substitution from PG.7 to PG.8

<b>MP-FLDXL-10</b>	-	60	254	363	468	633	1101	1222	-
<b>MP-FLDXL-20</b>	-	-	194	303	408	573	1041	1162	-
<b>MP-FLDXL-30</b>	-	-	-	109	214	379	847	968	-
<b>MP-FLDXL-40</b>	-	-	-	-	105	270	738	859	-
<b>MP-FLDXL-50</b>	-	-	-	-	-	165	633	754	-
<b>MP-FLDXL-60</b>	-	-	-	-	-	-	468	589	-
<b>MP-FLDXL-70</b>	-	-	-	-	-	-	-	121	-

## Additional equipment

Order no.  
W H D

Hinge side: Carcass depth	Decor groups									
	M10	M20	M30	M40	M50	M60	M70	M80	M90	

Surcharge for tall cabinets with glass fronts inside and exterior in the same design available in decor groups: S/B/H/MP/F/Z

<b>IDF-G</b>	-	-	-	-	1646	-	1646	1646	-
--------------	---	---	---	---	------	---	------	------	---

M 10	M 20	M 30	M 40	M 50
K M10 laminate				B M50 Velvet lacquer S M50 microstructure lacquer
M 60	M 70	M 80	M 90	
	F M70 veneer / oak / walnut Z M70 Veneer / Bavaria	H M80 high gloss-Lacquer MP M80 laqué mat Premium		

# Examples, Special finish / Function change behind the front

## Oven tall unit GO 60 20 28 XB3

Drawer 12.6 cm high, fixed panel will be changed to 12.6 cm high

### Procedure:

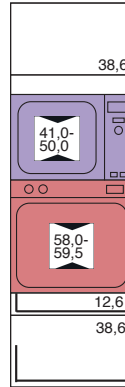
1. Selection of the item **GO 60 20 28 XB3**
2. Front division can not be changed.
3. 1 drawer 12.6 cm high will be changed to 1 fixed panel 12.6 cm high

Calculation, e.g. price group 1:

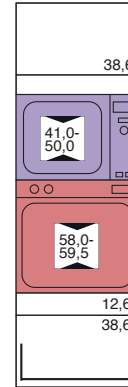
Tall unit **GO 60 20 28 XB3**

Replacement fixed panel instead of drawer without charge

Standard tall unit



Special tall unit



TX06013.BF

## Oven tall unit GO 60 20 28 XB3

Pull-out 38.6 cm high, with drawer 38.6 cm high

### Procedure:

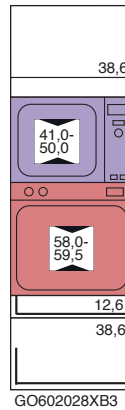
1. Selection of the item **GO 60 20 28 XB3**
2. Front division can not be changed.
3. 1 pull-out 38.6 cm will be changed to 1 drawer 38.6 cm high

Calculation, e.g. price group 1:

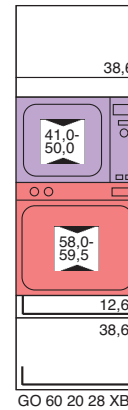
Tall unit **GO 60 20 28 XB3**

Drawer instead of pull-out without charge

Standard tall unit



Special tall unit



TX060395.S

## Oven tall unit GO 60 20 28 XB3

Pull-out 38.6 cm high, with drawer 38.6 cm high with internal drawer

### Procedure:

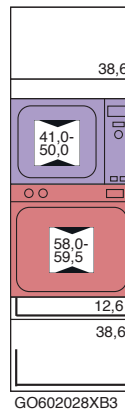
1. Selection of the item **GO 60 20 28 XB3**
2. Front division can not be changed.
3. 1 pull-out 38.6 cm will be changed to drawer with internal drawer

Calculation, e.g. price group 1:

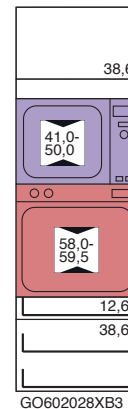
Tall unit **GO 60 20 28 XB3**

Drawer instead of pull-out without charge  
additional internal drawer **E-ISK 600055**

Standard tall unit



Special tall unit



TX060393.SIS

# Examples, Special finish / Function change behind the front

Appliance unit GI 60 20 50 X  
 Hinged door 38.6 cm high will be changed to flap door 38.6 cm high

**Procedure:**

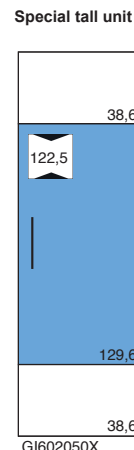
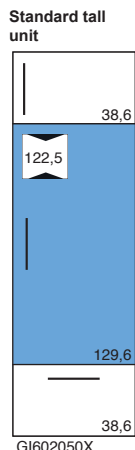
1. Selection of the article **GI 60 20 50 X**
2. Front division can not be changed.
3. 1 hinged door 38.6 cm high will be changed to 1 flap door

Calculation, e.g. price group 1:

Tall unit **GI 60 20 50 X**

Replacement flap door instead of hinged door

TX060395.KLOB



Appliance unit GI 60 20 50 1X  
 Hinged door 77.6 cm high will be changed to hinged door 77.6 cm high  
 with 2 internal pull-outs

**Procedure:**

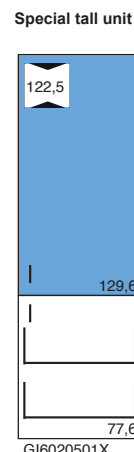
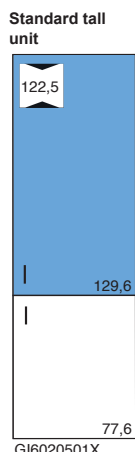
1. Selection of the article **GI 60 20 50 1X**
2. Front division can not be changed.
3. 1 hinged door 77.6 cm will be changed to 1 hinged door 77.6 cm with 2 internal pull-outs

Calculation, e.g. price group 1:

Tall unit **GI 60 20 50 1X**

2 internal pull-outs **E-IAZ600055 (2x)**

TX060785.TIA2



Appliance unit GI 60 20 50 X  
 Tall larder unit with the same front division as tall unit for refrigerator.  
 A symmetrical front appearance is also achieved in connection with e.g. an oven tall unit

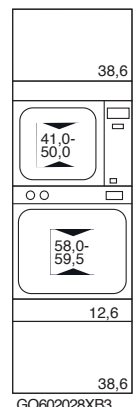
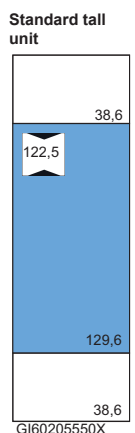
**Procedure:**

1. Selection of the article **GI 60 20 50 X**
2. Front division can not be changed.
3. 1 door 129.6 cm high for internal aperture, will be changed to 1 door 129.6 cm high with 3 adjustable shelves

Calculation, e.g. price group 1:

Tall unit **GI 60 20 50X**

Internal aperture with full back panel **TX0601305.NIRE3** and 3 adjustable shelves

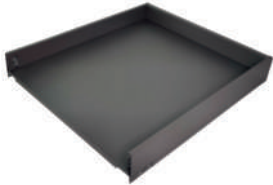


## Drawers / Pull-outs

■ = Models also available in 34 cm and 45.5 cm carcass depth (Order no.: ... replace ... 55 ... with 34/45)

Order no.

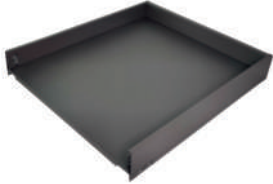
Price



**Drawer without front for carcass depths 34 cm, 45.5 cm and 55.5 cm**  
With cushioned self-closing mechanism and full pull-out  
Incl. guides

Ill. shows Legrabox pure Art

E-SKO300055	■	82
E-SKO400055	■	83
E-SKO450055	■	84
E-SKO500055	■	85
E-SKO600055	■	87
E-SKO700055	■	100
E-SKO800055	■	100
E-SKO900055	■	103
E-SKO1000055	■	107
E-SKO1200055	■	111



**drawer without front for carcass depth 70.5 cm**  
With cushioned self-closing mechanism and full pull-out  
Incl. guides

Ill. shows Legrabox pure Art

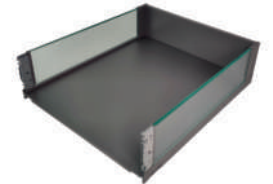
E-SKO300070		126
E-SKO400070		131
E-SKO450070		133
E-SKO500070		136
E-SKO600070		137
E-SKO700070		148
E-SKO800070		148
E-SKO900070		153
E-SKO1000070		156
E-SKO1200070		162



**Pull-out without front for carcass depths 34 cm, 45.5 cm and 55.5 cm**  
With cushioned self-closing mechanism and full pull-out  
Incl. guides

Ill. shows Legrabox pure Art

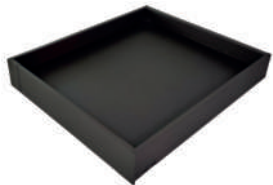
E-AZO300055	■	123
E-AZO400055	■	125
E-AZO450055	■	126
E-AZO500055	■	129
E-AZO600055	■	131
E-AZO700055	■	166
E-AZO800055	■	166
E-AZO900055	■	171
E-AZO1000055	■	173
E-AZO1200055	■	179



**Pull-out without front for carcass depth 70.5 cm**  
With cushioned self-closing mechanism and full pull-out  
Incl. guides

Ill. shows Legrabox free

E-AZO300070		188
E-AZO400070		191
E-AZO450070		192
E-AZO500070		193
E-AZO600070		194
E-AZO700070		210
E-AZO800070		210
E-AZO900070		213
E-AZO1000070		216
E-AZO1200070		224



**internal drawer**  
With cushioned self-closing mechanism and full pull-out  
Incl. guides

Ill. shows Legrabox pure Art



**Planning advice:**  
Take account of opening angle

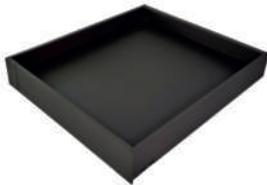
E-ISK300055	■	107
E-ISK400055	■	111
E-ISK450055	■	112
E-ISK500055	■	114
E-ISK600055	■	118
E-ISK700055	■	133
E-ISK800055	■	133
E-ISK900055	■	138
E-ISK1000055	■	144
E-ISK1200055	■	148

# Drawers / Pull-outs

■ = Models also available in 34 cm and 45.5 cm carcass depth (Order no.: ... replace ... 55 ... with 34/45)

Order no.

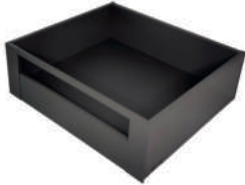
Price



**Internal drawer for 70.5 cm carcass depth**  
With cushioned self-closing mechanism and full pull-out

Ill. shows Legrabox pure Art

E-ISK300070	153
E-ISK400070	159
E-ISK450070	161
E-ISK500070	162
E-ISK600070	165
E-ISK700070	182
E-ISK800070	182
E-ISK900070	187
E-ISK1000070	193
E-ISK1200070	199



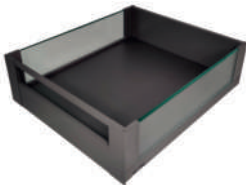
**Internal pull-out**  
With cushioned self-closing mechanism and full pull-out  
Incl. guides

Ill. shows Legrabox pure Art



**Planning advice:**  
Door with wide angle hinges  
Take account of opening angle

E-IAZ300055	■	154
E-IAZ400055	■	161
E-IAZ450055	■	163
E-IAZ500055	■	166
E-IAZ600055	■	171
E-IAZ700055	■	216
E-IAZ800055	■	216
E-IAZ900055	■	222
E-IAZ1000055	■	229
E-IAZ1200055	■	236



**Internal pull-out for 70.5 cm carcass depth**  
With cushioned self-closing mechanism and full pull-out

Ill. shows Legrabox free



**Planning advice:**  
Door with wide angle hinges  
Take account of opening angle

E-IAZ300070	227
E-IAZ400070	234
E-IAZ450070	236
E-IAZ500070	239
E-IAZ600070	245
E-IAZ700070	262
E-IAZ800070	262
E-IAZ900070	267
E-IAZ1000070	271
E-IAZ1200070	287

**Extra charge for 2 wide angle hinges 155 degrees**

SA90155E2	10,50
-----------	-------

**Extra charge for 3 wide angle hinges 155 degrees**

SA90155E3	17,10
-----------	-------





## 6.1

## Tall units 143 cm

Tall units 143 cm high	XL 6.1.2-XL 6.1.6
Tall units 143 cm high with glass fronts	XL 6.1.6
Additional equipment	XL 6.1.6
Tall units 143 cm high with roller shutter	XL 6.1.7
Tall units 143 cm high for microwave / oven	XL 6.1.8
Tall units 143 cm high for microwave / oven Double aperture	XL 6.1.9
Tall units 143 cm high for microwave / oven Lifting door / aperture	XL 6.1.9
Tall units 143 cm high for refrigerator/freezer spacefitter frame 143 cm high	XL 6.1.9-XL 6.1.10
Front filler 143 cm high	XL 6.1.10
Back cladding 143 cm high with screw-fitted fronts	XL 6.1.11
Back cladding 143 cm high	XL 6.1.11
Visible sides / increased side depth 143 cm high	XL 6.1.12
Shelf units 143 cm high	XL 6.1.12
Dishwasher surround 143 cm high	XL 6.1.13
Raised dishwashers For carcass height 143 cm, carcass depth 55.5 cm	XL 6.1.14

## Legend:



Available with grip ledge N...



Not available with grip ledge N...



This symbol indicates which models are available



This symbol indicates which models are not available



wall-mounted units



available depths for wall-mounted units



Planning advice



This symbol illustrates which appliance units are delivered with integrated ventilation



Not available with „push-to-open“ fitting



Aperture height specifications



Available carcass depths 34/45.5/55.5/61.0 cm

























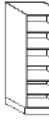


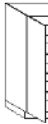













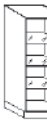




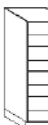

Available carcass depths 45.5/55.5/61.0 cm



Available carcass depths 55.5/61.0 cm

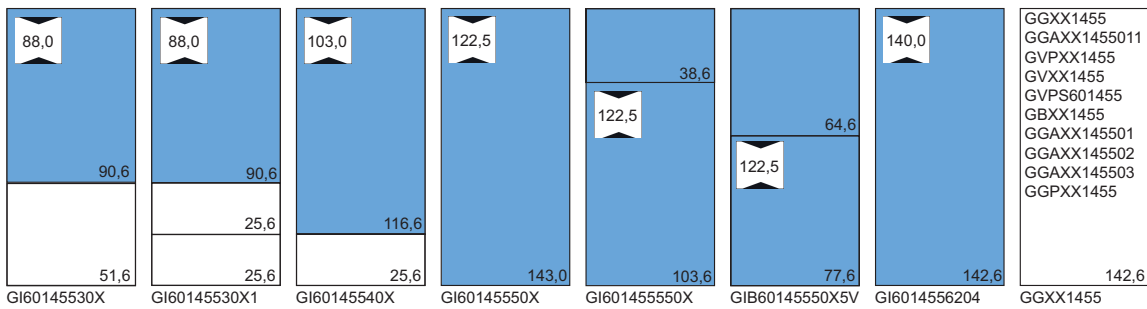
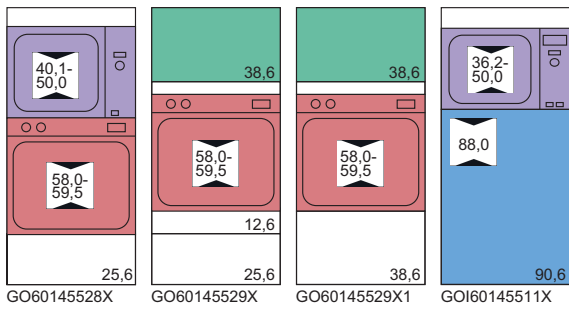
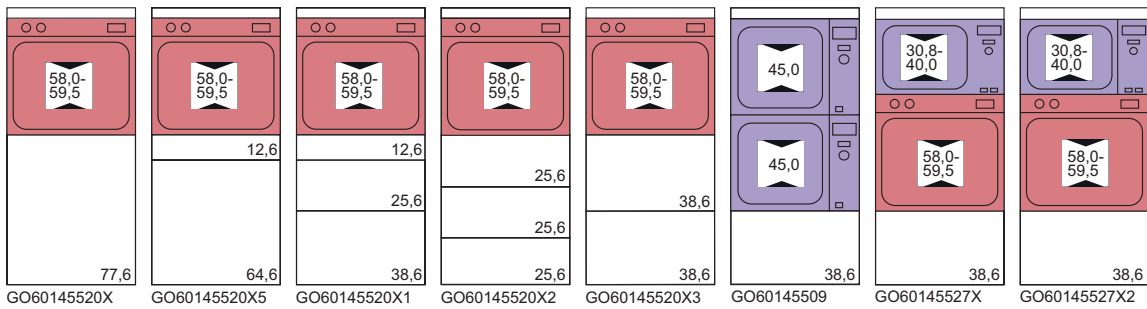
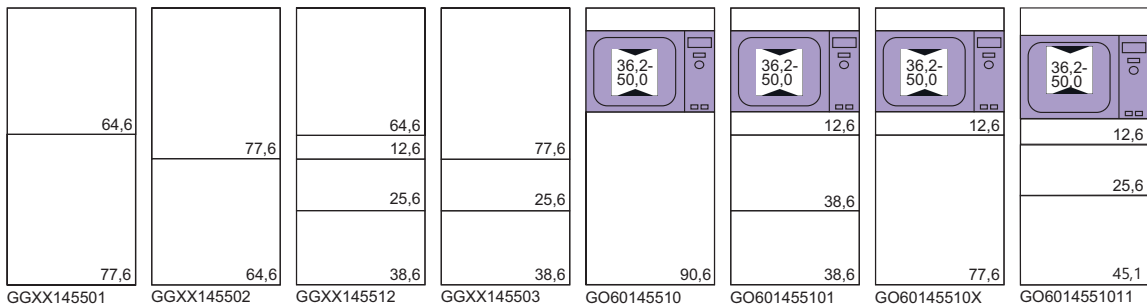
Height  
1.43 cm

# The most important tall unit types 143 cm high

Page XL 6.1.2	Page XL 6.1.2	Page XL 6.1.2	Page XL 6.1.2	Page XL 6.1.2	Page XL 6.1.2	Page XL 6.1.2	Page XL 6.1.2	Page XL 6.1.2
								
GGs..145502 Unit widths: 25	GGs..145501 Unit widths: 25	GGs..1455 Unit widths: 25	GVSTP..145502 Unit widths: 25	GVSTP..145501 Unit widths: 25	GVSTP..1455 Unit widths: 25	GV..145502 Unit widths: 30/45	GV..145501 Unit widths: 30/45	GV..1455 Unit widths: 30/45
Page XL 6.1.2	Page XL 6.1.2	Page XL 6.1.3	Page XL 6.1.3	Page XL 6.1.3	Page XL 6.1.3	Page XL 6.1.3	Page XL 6.1.3	Page XL 6.1.3
								
GVP..145502 Unit widths: 30/45	GVP..145501 Unit widths: 30/45	GVP..1455 Unit widths: 30/45	GVP..1455 Unit widths: 50/60	GVP..01455 Unit widths: 100	GV..145502 Unit widths: 50/60	GV..145501 Unit widths: 50/60	GV..1455 Unit widths: 50/60	GVPS..1455 Unit widths: 60
Page XL 6.1.3	Page XL 6.1.3	Page XL 6.1.3	Page XL 6.1.3	Page XL 6.1.3	Page XL 6.1.4	Page XL 6.1.4	Page XL 6.1.4	Page XL 6.1.4
								
GVT..1455 Unit widths: 50/60	GVP..01455 Unit widths: 50/60	GG..145502 Unit widths: 30/40/45/50/60	GG..145503 Unit widths: 30/40/45/50/60	GG..145501 Unit widths: 30/40/45/50/60	GG..145512 Unit widths: 30/40/45/50/60	GG..1455 Unit widths: 30/40/45/50/60	GG..1455 Unit widths: 80/90	GGA..145501 Unit widths: 30/40/45/50/60
Page XL 6.1.4	Page XL 6.1.4	Page XL 6.1.4	Page XL 6.1.4	Page XL 6.1.4	Page XL 6.1.4	Page XL 6.1.5	Page XL 6.1.5	Page XL 6.1.5
								
GGA..145503 Unit widths: 30/40/45/50/60	GGA..145502 Unit widths: 30/40/45/50/60	GGA..1455 Unit widths: 90	GB..145570 Unit widths: 40/45/50/60	GB..145502 Unit widths: 30/40/45/50/60	GB..145501 Unit widths: 30/40/45/50/60	GEL..1455 Unit widths: 115/125	GEHL..1455 Unit widths: 115/125	GE..145570 Unit widths: 115/125
Page XL 6.1.5	Page XL 6.1.6	Page XL 6.1.6	Page XL 6.1.6	Page XL 6.1.7	Page XL 6.1.11	Page XL 6.1.11	Page XL 6.1.11	Page XL 6.1.12
								
GEH..145570 Unit widths: 115/125	UP..65 Unit widths: 3,5-20	UP..78 Unit widths: 3,5-20	GGGD..145570 Unit widths: 45/50/60	TAB-AZ..55 Unit widths: 45/50/60/80/90	GVF.. Unit widths: 10-250	GVF..01 Unit widths: 10-250	GVF..02 Unit widths: 10-250	GR..1458 Unit widths: 30/40/45/50/60
Page XL 6.1.12								
								
GRA..1458 Unit widths: 25/34								



# Recess overview Tall units 143 cm



- GGXX1455
- GGAXX1455011
- GVPXX1455
- GVXX1455
- GVPS601455
- GBXX1455
- GGAXX145501
- GGAXX145502
- GGAXX145503
- GGPXX1455

# Tall units 143 cm high

Carcase depth 55.5 cm (standard)

- = Models also available in 34/45.5/61 cm carcass depth (Order no.: ... replace ... 55 ... with 34/45/61)
- = Models also available in 45.5/61 cm carcass depth (order no.: replace ... 55 ... with 45/61)
- ▲ = Types also available with 61 cm carcass depth (order no. ... replace ... 55 ... with 61)

Order no.  
W H D

Hinge side:	Carcass depth	Price groups								
		1	2	3	4	5	6	7	8	9
R/L	■	508	527	573	653	705	735	794	873	-
R/L	■	508	527	573	653	705	735	794	873	-
R/L	■	508	527	573	653	705	735	794	873	-
R/L	▲	1233	1254	1302	1364	1417	1445	1504	1654	-
R/L	▲	1233	1254	1302	1364	1417	1445	1504	1654	-
R/L	▲	1233	1254	1302	1364	1417	1445	1504	1654	-
	▲	850	873	897	1018	1071	1114	1200	1320	-
	▲	885	911	936	1071	1129	1176	1272	1399	-
	▲	850	873	897	1018	1071	1114	1200	1320	-
	▲	885	911	936	1071	1129	1176	1272	1399	-
	▲	850	873	897	1018	1071	1114	1200	1320	-
	▲	885	911	936	1071	1129	1176	1272	1399	-
	▲	850	873	897	1018	1071	1114	1200	1320	-
	▲	885	911	936	1071	1129	1176	1272	1399	-
	▲	974	1001	1056	1140	1193	1235	1322	1454	-
	▲	1021	1047	1073	1202	1259	1309	1403	1543	-
	▲	974	1001	1056	1140	1193	1235	1322	1454	-
	▲	1021	1047	1073	1202	1259	1309	1403	1543	-

**Crockery cupboard angled 37.2°**  
 1 door 77.6 cm  
 1 door 64.6 cm  
 1 fixed shelf  
 4 adjustable shelves  
 For adjacent fitting left or right

Ill. left

**Crockery cupboard angled 37.2°**  
 1 door 77.6 cm  
 1 door 77.6 cm  
 1 fixed shelf  
 4 adjustable shelves  
 For adjacent fitting left or right

Ill. left

**Crockery cupboard angled 37.2°**  
 1 door 142.6 cm  
 1 fixed shelf  
 3 adjustable shelves  
 For adjacent fitting left or right

Ill. left

**Larder unit angled 37.2°**  
 1 door 77.6 cm connected to 1 door 64.6 cm  
 1 pull-out element  
 4 adjustable wooden shelves with chrome-plated square rail  
 For adjacent fitting left or right

Ill. left

**Larder unit angled 37.2°**  
 1 door 64.6 cm connected to 1 door 77.6 cm  
 1 pull-out element  
 4 adjustable wooden shelves with chrome-plated square rail  
 For adjacent fitting left or right

Ill. left

**Larder unit angled 37.2°**  
 1 door 142.6 cm  
 1 pull-out element  
 4 adjustable wooden shelves with chrome-plated square rail  
 For adjacent fitting left or right

Ill. left

**Larder unit**  
 1 pull-out 142.6 cm  
 consisting of:  
 1 door 77.6 cm connected to 1 door 64.6 cm on telescopic rails, full height can be pulled out  
 With 4 adjustable wire baskets (chrome-plated)

Ill. left

**Larder unit**  
 1 pull-out 142.6 cm  
 consisting of:  
 1 door 64.6 cm connected to 1 door 77.6 cm on telescopic rails, full height can be pulled out  
 With 4 adjustable wire baskets (chrome-plated)

Ill. left

**Larder unit**  
 1 pull-out 142.6 cm  
 on telescopic rails, full height can be pulled out  
 With 4 adjustable wire baskets (chrome-plated)

Ill. left

**Larder unit**  
 1 pull-out 142.6 cm  
 consisting of:  
 1 door 77.6 cm connected to 1 door 64.6 cm on telescopic rails, full height can be pulled out  
 With 4 adjustable wooden shelves with chrome-plated, square rail

Ill. left

**Larder unit**  
 1 pull-out 142.6 cm  
 consisting of:  
 1 door 64.6 cm connected to 1 door 77.6 cm on telescopic rails, full height can be pulled out  
 With 4 adjustable wooden shelves with chrome-plated, square rail

Ill. left


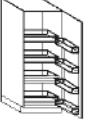
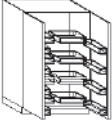


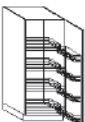
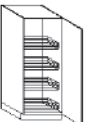
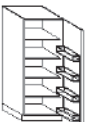
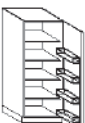





# Tall units 143 cm high

Carcase depth 55.5 cm (standard)

■ = Models also available in 34/45.5/61 cm carcass depth (Order no.: ... replace ... 55 ... with 34/45/61)  
 □ = Models also available in 45.5/61 cm carcass depth (order no.: replace ... 55 ... with 45/61)  
 ▲ = Types also available with 61 cm carcass depth (order no.: ... replace ... 55 ... with 61)

Order no.  
W H D

	Hinge side:	Carcass depth	Price groups										
			1	2	3	4	5	6	7	8	9		
1426  <b>Larder unit</b> 1 pull-out 142.6 cm on telescopic rails, full height can be pulled out With 4 adjustable wooden shelves with chrome-plated, square rail			<b>GVP 30 14 55</b>	▲	974	1001	1056	1140	1193	1235	1322	1454	-
			<b>GVP 45 14 55</b>	▲	1021	1047	1073	1202	1259	1309	1403	1543	-
1426  <b>Larder unit</b> 1 door 142.6 cm 1 swivel and pull-out element 4 adjustable and 4 adjustable wooden shelves with chrome-plated square rail	R/L	▲	<b>GVP 50 14 55</b>	▲	1711	1727	1778	1876	1921	1953	2010	2211	-
	R/L	▲	<b>GVP 60 14 55</b>	▲	1765	1787	1841	1989	2045	2079	2151	2366	-
1426  <b>Larder unit</b> 2 doors 142.6 cm 2 swivel and pull-out elements each 4 adjustable and each connected with 4 adjustable wooden shelves with chrome-plated square rail		▲	<b>GVP 100 14 55</b>	▲	3409	3442	3544	3741	3827	3890	4009	4410	-
776 646  <b>Larder unit</b> 1 door 77.6 cm connected to 1 door 64.6 cm 1 swivel and pull-out element 4 adjustable and 4 removable wire baskets (chrome-plated)	R/L	▲	<b>GV 50 14 55 02</b>	▲	1454	1468	1520	1624	1670	1702	1760	1936	-
	R/L	▲	<b>GV 60 14 55 02</b>	▲	1502	1522	1577	1732	1787	1823	1892	2081	-
646 776  <b>Larder unit</b> 1 door 64.6 cm connected to 1 door 77.6 cm 1 swivel and pull-out element 4 adjustable and 4 removable wire baskets (chrome-plated)	R/L	▲	<b>GV 50 14 55 01</b>	▲	1454	1468	1520	1624	1670	1702	1760	1936	-
	R/L	▲	<b>GV 60 14 55 01</b>	▲	1502	1522	1577	1732	1787	1823	1892	2081	-
1426  <b>Larder unit</b> 1 door 142.6 cm 1 swivel and pull-out element 4 adjustable and 4 removable wire baskets (chrome-plated)	R/L	▲	<b>GV 50 14 55</b>	▲	1454	1468	1520	1624	1670	1702	1760	1936	-
	R/L	▲	<b>GV 60 14 55</b>	▲	1502	1522	1577	1732	1787	1823	1892	2081	-
1426  <b>Larder unit</b> 1 door 142.6 cm 1 pull-out element 4 adjustable wooden shelves with chrome-plated square rail	R/L	▲	<b>GVPS 60 14 55</b>	▲	1271	1287	1343	1503	1558	1593	1664	1830	-
1426  <b>Larder unit</b> 1 door 142.6 cm 4 chrome-plated wire baskets Adjustable in height 4 adjustable shelves reduced in depth	R/L	▲	<b>GVT 50 14 55</b>	▲	762	774	827	959	1003	1035	1094	1203	-
	R/L	▲	<b>GVT 60 14 55</b>	▲	818	833	893	1072	1129	1160	1232	1355	-
					💡 The adjustable shelves will be delivered as a separate package.								
1426  <b>Larder unit</b> 1 door 142.6 cm 4 wooden shelves with chrome-plated square rail Adjustable in height 4 adjustable shelves reduced in depth	R/L	▲	<b>GVPT 50 14 55</b>	▲	795	808	860	993	1038	1068	1129	1242	-
	R/L	▲	<b>GVPT 60 14 55</b>	▲	852	866	925	1107	1162	1196	1268	1395	-
					💡 The adjustable shelves will be delivered as a separate package.								
776 646  <b>Crockery cupboard</b> 1 door 77.6 cm 1 door 64.6 cm 1 fixed shelf 4 adjustable shelves		■	<b>GG 30 14 55 02</b>	■	328	341	392	477	528	557	618	680	-
		■	<b>GG 40 14 55 02</b>	■	328	341	392	477	528	557	618	680	-
		■	<b>GG 45 14 55 02</b>	■	328	341	392	477	528	557	618	680	-
		■	<b>GG 50 14 55 02</b>	■	328	341	392	526	569	601	660	726	-
		■	<b>GG 60 14 55 02</b>	■	367	381	440	621	677	710	782	860	-
776 256 386  <b>Crockery cupboard</b> 1 door 77.6 cm 1 pull-out 25.6 cm 1 pull-out 38.6 cm 2 adjustable shelves		■	<b>GG 30 14 55 03</b>	■	658	674	723	807	859	889	950	1045	-
		■	<b>GG 40 14 55 03</b>	■	658	674	723	807	859	889	950	1045	-
		■	<b>GG 45 14 55 03</b>	■	658	674	723	807	859	889	950	1045	-
		■	<b>GG 50 14 55 03</b>	■	658	674	723	856	901	931	991	1090	-
		■	<b>GG 60 14 55 03</b>	■	699	713	772	953	1009	1042	1113	1224	-
646 776  <b>Crockery cupboard</b> 1 door 64.6 cm 1 door 77.6 cm 1 fixed shelf 4 adjustable shelves		■	<b>GG 30 14 55 01</b>	■	328	341	392	477	528	557	618	680	-
		■	<b>GG 40 14 55 01</b>	■	328	341	392	477	528	557	618	680	-
		■	<b>GG 45 14 55 01</b>	■	328	341	392	477	528	557	618	680	-
		■	<b>GG 50 14 55 01</b>	■	328	341	392	526	569	601	660	726	-
		■	<b>GG 60 14 55 01</b>	■	367	381	440	621	677	710	782	860	-

78

78

# Tall units 143 cm high

Carcase depth 55.5 cm (standard)

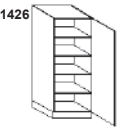
- = Models also available in 34/45.5/61 cm carcass depth (Order no.: ... replace ... 55 ... with 34/45/61)
- = Models also available in 45.5/61 cm carcass depth (order no.: replace ... 55 ... with 45/61)
- ▲ = Types also available with 61 cm carcass depth (order no. ... replace ... 55 ... with 61)

Order no.  
W H D

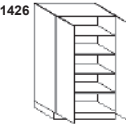
Hinge side:	Carcass depth	Price groups									
		1	2	3	4	5	6	7	8	9	
R/L ■	78	GG 30 14 55 12	803	816	866	951	1004	1032	1094	1203	-
		GG 40 14 55 12	803	816	866	951	1004	1032	1094	1203	-
		GG 45 14 55 12	803	816	866	951	1004	1032	1094	1203	-
		GG 50 14 55 12	803	816	866	1002	1044	1075	1136	1250	-
		GG 60 14 55 12	843	858	916	1096	1151	1186	1257	1383	-
R/L ■	□	GG 30 14 55	328	341	392	477	528	557	618	680	-
		GG 40 14 55	328	341	392	477	528	557	618	680	-
		GG 45 14 55	328	341	392	477	528	557	618	680	-
		GG 50 14 55	328	341	392	526	569	601	660	726	-
R/L ■	□	GG 80 14 55	710	737	841	997	1064	1115	1229	1352	-
		GG 90 14 55	710	737	841	997	1064	1115	1229	1352	-
R/L ■	78	GGA 30 14 55 01	1015	1027	1078	1145	1197	1226	1289	1418	-
		GGA 40 14 55 01	1058	1071	1121	1187	1239	1270	1332	1465	-
		GGA 45 14 55 01	1058	1071	1121	1187	1239	1270	1332	1465	-
		GGA 50 14 55 01	1074	1087	1137	1253	1296	1329	1390	1529	-
		GGA 60 14 55 01	1135	1150	1207	1371	1428	1461	1532	1685	-
R/L ■	□	GGA 30 14 55 03	970	981	1032	1101	1152	1183	1244	1368	-
		GGA 40 14 55 03	1006	1019	1070	1136	1188	1219	1279	1407	-
		GGA 45 14 55 03	1006	1019	1070	1136	1188	1219	1279	1407	-
		GGA 50 14 55 03	1021	1034	1084	1200	1247	1276	1338	1472	-
		GGA 60 14 55 03	1080	1096	1152	1319	1374	1407	1478	1626	-
R/L ■	□	GGA 30 14 55 02	958	971	1021	1090	1142	1172	1232	1355	-
		GGA 40 14 55 02	997	1012	1063	1130	1182	1212	1247	1372	-
		GGA 45 14 55 02	997	1012	1063	1130	1182	1212	1247	1372	-
		GGA 50 14 55 02	1017	1026	1077	1194	1237	1270	1331	1464	-
		GGA 60 14 55 02	1072	1088	1144	1310	1364	1398	1470	1617	-
R/L ■	□	GGA 90 14 55	1573	1597	1699	1843	1948	2007	2132	2345	-
R/L ▲	78	GB 40 14 55 71	514	528	579	664	714	743	805	886	-
		GB 45 14 55 71	514	528	579	664	714	743	805	886	-
		GB 50 14 55 71	514	528	579	712	756	788	847	932	-
		GB 60 14 55 71	553	568	626	808	864	897	969	1066	-
R/L □	78	GB 30 14 55 02	328	341	392	477	528	557	653	718	-
		GB 40 14 55 02	328	341	392	477	528	557	653	718	-
		GB 45 14 55 02	328	341	392	477	528	557	653	718	-
		GB 50 14 55 02	328	341	392	526	569	601	660	726	-
		GB 60 14 55 02	367	381	440	621	677	710	782	860	-
R/L □	78	GB 30 14 55 01	328	341	392	477	528	557	653	718	-
		GB 40 14 55 01	328	341	392	477	528	557	653	718	-
		GB 45 14 55 01	328	341	392	477	528	557	653	718	-
		GB 50 14 55 01	328	341	392	526	569	601	660	726	-
		GB 60 14 55 01	367	381	440	621	677	710	782	860	-



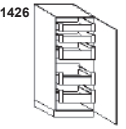
**Crockery cupboard**  
1 door 64.6 cm  
1 drawer 12.6 cm  
1 pull-out 25.6 cm  
1 pull-out 38.6 cm  
2 adjustable shelves



**Crockery cupboard**  
1 door 142.6 cm  
1 fixed shelf  
3 adjustable shelves



**Crockery cupboard**  
2 doors 142.6 cm  
1 fixed shelf  
3 adjustable shelves

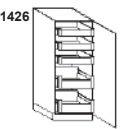


**Larder unit**  
1 door 142.6 cm with wide angle hinges  
2 internal drawers  
3 internal pull-outs

**Planning advice:**  
Take account of opening angle



**Planning advice:**  
Doors with wide angle hinges may not be planned alongside units or panels if the protrusion to the front of the adjoining article is greater than 3 cm (hinge side).  
Doors with wide angle hinges protrude over the carcass side.

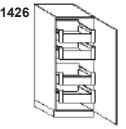


**Larder unit**  
1 door 142.6 cm with wide angle hinges  
3 internal drawers  
2 internal pull-outs

**Planning advice:**  
Take account of opening angle



**Planning advice:**  
Doors with wide angle hinges may not be planned alongside units or panels if the protrusion to the front of the adjoining article is greater than 3 cm (hinge side).  
Doors with wide angle hinges protrude over the carcass side.



**Larder unit**  
1 door 142.6 cm with wide angle hinges  
4 internal pull-outs

**Planning advice:**  
Take account of opening angle



**Planning advice:**  
Doors with wide angle hinges may not be planned alongside units or panels if the protrusion to the front of the adjoining article is greater than 3 cm (hinge side).  
Doors with wide angle hinges protrude over the carcass side.

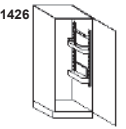


**Crockery cupboard**  
2 doors 142.6 cm with wide angle hinges  
2 internal pull-outs  
1 fixed shelf  
2 internal pull-outs

**Planning advice:**  
Take account of opening angle



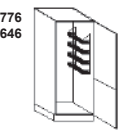
**Planning advice:**  
Doors with wide angle hinges may not be planned alongside units or panels if the protrusion to the front of the adjoining article is greater than 3 cm (hinge side).  
Doors with wide angle hinges protrude over the carcass side.



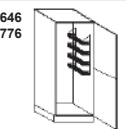
**Broom cupboard**  
1 door 142.6 cm  
1 hook rail with 5 hooks, anthracite  
Modular interior partitioning system, consisting of:  
1 set of attachment rails, anthracite  
1 large 3-side tray with rail, anthracite  
1 carrier box for cleaning materials with carrier rails, anthracite  
1 hook rail with 5 hooks, anthracite



**Optional accessories**  
HW HS Holder for vacuum cleaner hose or PET storage pocket (for screwing on), anthracite  
HW UTB Utensils box, e.g. for storing towels, cleaning cloths, etc. (for screwing on), anthracite



**Broom cupboard**  
1 door 77.6 cm connected to 1 door 64.6 cm  
1 storage basket  
1 hook rail



**Broom cupboard**  
1 door 64.6 cm connected to 1 door 77.6 cm  
1 storage basket  
1 hook rail

# Tall units 143 cm high

Carcase depth 55.5 cm (standard)

■ = Models also available in 34/45.5/61 cm carcass depth (Order no.: ... replace ... 55 ... with 34/45/61)  
 □ = Models also available in 45.5/61 cm carcass depth (order no.: replace ... 55 ... with 45/61)  
 ▲ = Types also available with 61 cm carcass depth (order no.: ... replace ... 55 ... with 61)

						Price groups								
Order no.	W	H	D	Hinge side:	Carcass depth	1	2	3	4	5	6	7	8	9
1426 	<b>Broom cupboard</b>													
	1 door 142.6 cm													
	1 storage basket													
	1 hook rail													
776 646 	<b>Broom cupboard</b>													
	1 door 77.6 cm connected to 1 door 64.6 cm													
	1 hook rail with 5 hooks, anthracite													
	Modular interior partitioning system, consisting of:													
	1 set of attachment rails, anthracite													
646 776 	<b>Broom cupboard</b>													
	1 door 64.6 cm connected to 1 door 77.6 cm													
	1 hook rail with 5 hooks, anthracite													
	Modular interior partitioning system, consisting of:													
	1 set of attachment rails, anthracite													
1426 	<b>„Le Mans“ tall corner unit</b>													
	Blind section left or right													
	1 door 142.6 cm, 1 fixed shelf,													
	4 wooden carousel shelves with chrome-plated rail fully swivelling „Le Mans“													
	Carcass width 100 cm													
1426 	<b>„Le Mans“ tall corner unit with side front panel for height offset</b>													
	1 door 142.6 cm, 1 fixed shelf,													
	1 panel in front colour 65cm wide, 142.6 cm high													
	For cladding the corner solution (enclosed)													
	4 wooden carousel shelves with chrome-plated rail fully swivelling „Le Mans“													
1426 	<b>tall corner unit blind section left or right</b>													
	1 door 142.6 cm													
	1 fixed shelf													
	4 adjustable shelves													
	Carcass width 100 cm with loose corner filler													
1426 	<b>Tall corner unit with side front panel for height offset</b>													
	1 door 142.6 cm													
	1 fixed shelf													
	1 panel in front colour 65cm wide, 142.6 cm high													
	4 adjustable shelves													

78

**Optional accessories**  
 HW HS Holder for vacuum cleaner hose or PET storage pocket (for screwing on), anthracite  
 HW UTB Utensils box, e.g. for storing towels, cleaning cloths, etc. (for screwing on), anthracite

**Optional accessories**  
 HW HS Holder for vacuum cleaner hose or PET storage pocket (for screwing on), anthracite  
 HW UTB Utensils box, e.g. for storing towels, cleaning cloths, etc. (for screwing on), anthracite

**Note:**  
 Please allow for shelf turning space and 50 cm clearance for carousel shelves.  
 Article consists of 2 packages:  
 1. Unit  
 2. Le Mans shelves

**Not available for:**  
 ALU TEC RP

**Note:**  
 Please allow for shelf turning space and 50 cm clearance for carousel shelves.  
 Article consists of 3 packages:  
 1. Unit  
 2. Front cladding, separate  
 3. Le Mans shelves

**Not available for:**  
 ALU TEC RP, ALUELEMENTS, ATLANTA-B, ATLANTA-S, BERGEN, CHALET-B, CHALET-S, FRAME, GENT, LUGANO, LUX-B, MIAMI, NOBEL-B, NOBEL-S, ORLANDO-B, ORLANDO-S, OSLO 15, SOFIE-B, SOFIE-S, STRIP ELEMENTS, TESSIN 15, TIM 15, VILLAGE 15-B, VILLAGE 15-S, VINO, VIVA, YORK-B, YORK-S

**Not available for:**  
 ALU TEC RP

**Note:**  
 Article consists of 2 packages:  
 1. Unit  
 2. Front cladding, separate  
 For height offset: When planning in conjunction with base units, please order additional base unit front filler.



**Not available for:**  
 ALU TEC RP, ALUELEMENTS, ATLANTA-B, ATLANTA-S, BERGEN, CHALET-B, CHALET-S, FRAME, GENT, LUGANO, LUX-B, MIAMI, NOBEL-B, NOBEL-S, ORLANDO-B, ORLANDO-S, OSLO 15, SOFIE-B, SOFIE-S, STRIP ELEMENTS, TESSIN 15, TIM 15, VILLAGE 15-B, VILLAGE 15-S, VINO, VIVA, YORK-B, YORK-S

## Tall units 143 cm high

Carcase depth 55.5 cm (standard)

- = Models also available in 34/45.5/61 cm carcass depth (Order no.: ... replace ... 55 ... with 34/45/61)
- = Models also available in 45.5/61 cm carcass depth (order no.: replace ... 55 ... with 45/61)
- ▲ = Types also available with 61 cm carcass depth (order no. ... replace ... 55 ... with 61)

Order no.  
W H D


				Hinge side:	Carcass depth	Price groups									
						1	2	3	4	5	6	7	8	9	
<b>For height offset: When planning in conjunction with base units, please order additional base unit front filler:</b>															
 <b>Base unit front filler</b> 3.5 - 10 cm 10.1 - 20 cm															
	<b>UP 10 65</b>					50	50	53	71	71	71	75	83	-	
<b>UP 20 65</b>					60	60	64	88	88	88	98	108	-		
 <b>Base unit front filler</b> 3.5 - 10 cm 10.1 - 20 cm															
	<b>UP 10 78</b>					53	53	54	86	86	86	94	103	-	
<b>UP 20 78</b>					60	60	68	117	117	117	123	135	-		

## Tall units 143 cm high with glass fronts

Carcass depth 55.5 cm (standard)

- = Models also available in 34/45.5/61 cm carcass depth (Order no.: ... replace ... 55 ... with 34/45/61)

Order no.  
W H D

				Hinge side:	Carcass depth	Glass groups				
						G1	G2	G2S	G5S	G6
1426  <b>Crockery cupboard with glass front</b> -neutral- 1 glass door 142.6 cm 3 adjustable glass shelves and 1 additional adjustable glass shelf for individual positioning	34.0 45.5 55.5 61.0	<b>GGGD 45 14 55 70</b>		R/L	■	-	-	807	944	1191
		<b>GGGD 50 14 55 70</b>		R/L	■	-	-	826	966	1210
		<b>GGGD 60 14 55 70</b>		R/L	■	-	-	900	1052	1284

G 1		G 2		G 2S	
<b>G1 AKTIVglass frame</b> 991 Matt glass 992 Translucent black glass		<b>G2 Design front</b> 925 Frame White Agate/Matt glass 935 Premium W. Frame/Matt Glass 940 Macaron Col. Frame/Matt Glass 95 Light grey frame/matt glass 96 Silver Col. Frame/Matt Glass 960 Snow White Frame/Matt Glass 97 Black frame/black glass		<b>G2S aluminium, framed glass door</b> 988 aluminium black, Linea glass 994 Aluminium frame/clear glass 995 aluminium frame/black glass	
G 5		G 5S		G 6	
		G5S aluminium, door with mullion 996 Alum.frame/clear gl./cross bar		<b>G6 NEW SALON</b> 986 aluminium black, black glass 987 aluminium black, clear glass 989 aluminium matt, bronze-coloured black glass 990 aluminium matt, bronze-coloured clear glass	

## Additional equipment


				Hinge side:	Carcass depth	Decor groups									
						M10	M20	M30	M40	M50	M60	M70	M80	M90	
<b>Surcharge for tall cabinets with glass fronts inside and exterior in the same design</b> available in decor groups: S/B/H/MP/F/Z															
<b>IDF-G</b>						-	-	-	-	1646	-	1646	1646	-	
M 10		M 20		M 30		M 40		M 50							
K M10 laminate								B M50 Velvet lacquer S M50 microstructure lacquer							
M 60		M 70		M 80		M 90									
		F M70 veneer / oak / walnut Z M70 Veneer / Bavaria		H M80 high gloss-Lacquer MP M80 laqué mat Premium											

# Tall units 143 cm high with roller shutter

The useable inside depth (bare dimension) for the following carcass depths is  
 36.1 cm – bare dimension 26.5 cm / 47.7 cm – bare dimension 38.1 cm  
 57.7 cm – bare dimension 48.1 cm / 63.2 cm – bare dimension 53.6 cm  
 ▲ = Types also available with 63.2 cm carcass depth (order no. ... replace ... 58 ... with 63)

Order no.  
W H D


Hinge side:	Carcass depth	Decor groups									
		M10	M20	M30	M40	M50	M60	M70	M80	M90	
▲	1338	-	-	-	-	3018	-	3549	-	-	
▲	1400	-	-	-	-	3080	-	3610	-	-	
▲	2737	-	-	-	-	4417	-	4948	-	-	

 **Tall unit with roller shutter 143 cm high**  
 Roller shutter stainless steel decor  
 3 adjustable shelves  
 1 structural shelf  
 3 sockets

**GJG 60 14 58 77**  
 optional accessory:  
 only TAB-A\*\*45 can be used as a pull-out shelf, and only 577 mm deep  
 No visible sides possible in other decor groups

**as above, but Tall unit with roller shutter 143 cm high 47,7 cm deep**

**GJG 60 14 48 77**  
 No visible sides possible in other decor groups

 **Tall unit with roller shutter 143 cm high**  
 Roller shutters black laminate  
 3 adjustable shelves  
 1 structural shelf  
 3 sockets

**GJG 60 14 58 78**  
 optional accessory:  
 only TAB-A\*\*45 can be used as a pull-out shelf, and only 577 mm deep  
 No visible sides possible in other decor groups

**as above, but Tall unit with roller shutter 143 cm high 47,7 cm deep**


**GJG 60 14 48 78**  
 No visible sides possible in other decor groups

 **Tall unit SMARTGLAS roller shutters 143 cm high 57,7 cm deep**  
 3 adjustable shelves  
 1 structural shelf  
 3 sockets

**GJSGG 60 14 58**  
 Panel, guide profile and handle in the same colour as the roller shutter  
 optional accessory:  
 only TAB-A\*\*45 can be used as a pull-out shelf, and only 577 mm deep  
 No visible sides possible in other decor groups

**as above, but Tall unit SMARTGLAS roller shutters 143 cm high 47,7 cm deep**

**GJSGG 60 14 48**

 **Pull-out shelf with guide rails**  
 With locking function, full pull-out „push to open“, shelf from decor group K  
 For carcass width 45 cm, 50 cm, 60 cm  
 For carcass width 80 cm, 90 cm  
 for carcass depths 45.5 cm and 55.5 cm  
 Load-bearing capacity depth 55.5 cm: 35 kg  
 Load-bearing capacity depth 45.5 cm: 35 kg  
 Load-bearing capacity depth 55.5 cm: 35 kg  
 Load-bearing capacity depth 45.5 cm: 35 kg  
 Load-bearing capacity depth 55.5 cm: 35 kg  
 Load-bearing capacity depth 45.5 cm: 35 kg  
 Load-bearing capacity depth 55.5 cm: 30 kg  
 Load-bearing capacity depth 45.5 cm: 30 kg  
 Load-bearing capacity depth 55.5 cm: 30 kg  
 Load-bearing capacity depth 45.5 cm: 30 kg

**Important:**  
 When installing in units with hinged doors always take wide angle hinges SA-90155E3 into consideration.

<b>TAB-AZ45 55</b>	220	-	-	-	-	-	-	-	-	-
<b>TAB-AZ45 45</b>	220	-	-	-	-	-	-	-	-	-
<b>TAB-AZ50 55</b>	225	-	-	-	-	-	-	-	-	-
<b>TAB-AZ50 45</b>	225	-	-	-	-	-	-	-	-	-
<b>TAB-AZ60 55</b>	234	-	-	-	-	-	-	-	-	-
<b>TAB-AZ60 45</b>	234	-	-	-	-	-	-	-	-	-
<b>TAB-AZ80 55</b>	282	-	-	-	-	-	-	-	-	-
<b>TAB-AZ80 45</b>	282	-	-	-	-	-	-	-	-	-
<b>TAB-AZ90 55</b>	298	-	-	-	-	-	-	-	-	-
<b>TAB-AZ90 45</b>	298	-	-	-	-	-	-	-	-	-

M 10	M 20	M 30	M 40	M 50
K M10 laminate				B M50 Velvet Lacquer S Microstructure lacquer

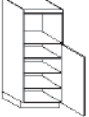
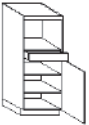
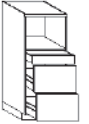
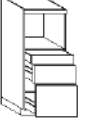
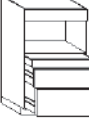
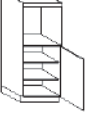
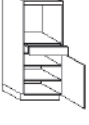
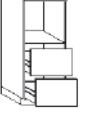
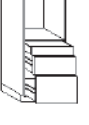
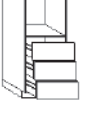
M 60	M 70	M 80	M 90
	F M70 veneer / oak / walnut Z M70 Veneer / Bavaria		



# Tall units 143 cm high for microwave / oven

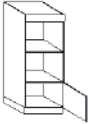
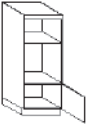
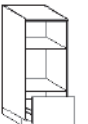
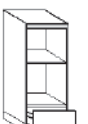
Carcase depth 55.5 cm (standard)

▲ = Types also available with 61 cm carcass depth (order no. ... replace ... 55 ... with 61)

				Price groups												
Order no.				Hinge side:	Carcass depth	1	2	3	4	5	6	7	8	9		
W H D																
906		<b>Appliance unit</b> 1 panel 1 appliance aperture 36.2 - 50 cm 1 door 90.6 cm 3 adjustable shelves	36,2-50,0	GO	60 14 55 10	R/L	▲	407	421	481	570	608	639	702	772	-
126 776		<b>Appliance unit</b> 1 panel 1 appliance aperture 36.2 - 50 cm 1 drawer 12.6 cm 1 door 77.6 cm 2 adjustable shelves	36,2-50,0 78	GO	60 14 55 10 X	R/L	▲	448	463	504	568	611	650	708	779	-
126 386 386		<b>Appliance unit</b> 1 panel 1 appliance aperture 36.2 - 50 cm 1 drawer 12.6 cm 2 pull-outs 38.6 cm	36,2-50,0 78	GO	60 14 55 10 1		▲	884	900	958	1047	1087	1115	1180	1298	-
126 256 451		<b>Appliance unit</b> 1 panel 1 appliance aperture 36.2 - 50 cm 1 drawer 12.6 cm 1 pull-out 25.6 cm 1 pull-out 45.1 cm	36,2-50,0 84,5	GO	60 14 55 10 11		▲	Not available for: MIAMI, VIVA								
126 256 386		<b>Appliance unit</b> 1 panel 1 appliance aperture 46 - 59.5 cm 1 drawer 12.6 cm 1 pull-out 25.6 cm 1 pull-out 38.6 cm	46,0-59,5 78	GO	90 14 55 10 12		▲	1140	1160	1212	1277	1336	1390	1462	1608	-
776		<b>Appliance unit</b> 1 panel 1 appliance aperture 58.0 - 59.5 cm 1 door 77.6 cm 2 adjustable shelves	58,0-59,5 78	GO	60 14 55 20 X	R/L	▲	363	375	417	481	524	563	621	683	-
126 646		<b>Appliance unit</b> 1 panel 1 appliance aperture 58.0 - 59.5 cm 1 drawer 12.6 cm 1 door 64.6 cm 2 adjustable shelves	58,0-59,5 78	GO	60 14 55 20 X5	R/L	▲	448	463	504	568	611	650	708	779	-
386 386		<b>Appliance unit</b> 1 panel 1 appliance aperture 58.0 - 59.5 cm 2 pull-outs 38.6 cm	58,0-59,5 78	GO	60 14 55 20 X3		▲	693	708	747	812	854	897	953	1048	-
126 256 386		<b>Appliance unit</b> 1 panel 1 appliance aperture 58.0 - 59.5 cm 1 drawer 12.6 cm 1 pull-out 25.6 cm 1 pull-out 38.6 cm	58,0-59,5 78	GO	60 14 55 20 X1		▲	838	852	894	956	997	1039	1096	1206	-
256 256 256		<b>Appliance unit</b> 1 panel 1 appliance aperture 58.0 - 59.5 cm 3 pull-outs 25.6 cm	58,0-59,5 78	GO	60 14 55 20 X2		▲	879	895	932	996	1039	1080	1137	1251	-

## Tall units 143 cm high for microwave / oven Double aperture

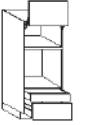
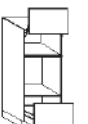
Carcase depth 55.5 cm (standard)

				Price groups											
				Order no.	Hinge side:	Carcase depth	1	2	3	4	5	6	7	8	9
				W H D											
386		<b>Appliance unit</b> 1 panel 1 appliance aperture 45.0 cm 1 appliance aperture 45.0 cm 1 door 38.6 cm	45,0 45,0	<b>GO 60 14 55 09</b>	R/L	▲	373	395	432	493	536	576	626	689	-
386		<b>Appliance unit</b> 1 panel 1 appliance aperture 30.8 - 40 cm 1 appliance aperture 58.0 - 59.5 cm 1 door 38.6 cm	30,8-40,0 58,0-59,5	<b>GO 60 14 55 27 X</b>	R/L	▲	349	368	407	471	508	550	603	663	-
386		<b>Appliance unit</b> 1 panel 1 appliance aperture 30.8 - 40 cm 1 appliance aperture 58.0 - 59.5 cm 1 pull-out 38.6 cm	30,8-40,0 58,0-59,5	<b>GO 60 14 55 27 X2</b>		▲	496	517	554	618	657	700	750	825	-
256		<b>Appliance unit</b> 1 panel 1 appliance aperture 40.1 - 50.0 cm 1 appliance aperture 58.0 - 59.5 cm 1 drawer 25.6 cm	40,1-50,0 58,0-59,5	<b>GO 60 14 55 28 X</b>		▲	489	513	585	685	717	754	825	908	-

## Tall units 143 cm high for microwave / oven Lifting door / aperture

Carcase depth 55.5 cm (standard)

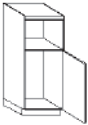

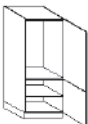

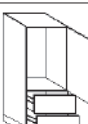



▲ = Types also available with 61 cm carcass depth (order no. ... replace ... 55 ... with 61)

386 126 256		<b>Appliance unit</b> 1 lifting door 38.6 cm 1 panel 1 appliance aperture 58.0 - 59.5 cm 1 drawer 12.6 cm 1 pull-out 25.6 cm	58,0-59,5	<b>GO 60 14 55 29 X</b>		▲	727	738	748	819	828	841	883	971	-
386 386		<b>Appliance unit</b> 1 lifting door 38.6 cm 1 panel 1 appliance aperture 58.0 - 59.5 cm 1 pull-out 38.6 cm	58,0-59,5	<b>GO 60 14 55 29 X1</b>		▲	585	599	617	682	689	692	700	770	-

## Tall units 143 cm high for refrigerator/freezer

Carcase depth 55.5 cm (standard)

▲ = Types also available with 61 cm carcass depth (order no. ... replace ... 55 ... with 61)

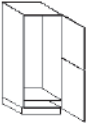



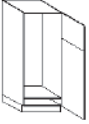

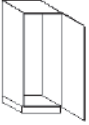

906 256		<b>Appliance unit</b> 1 panel 1 appliance aperture 36.2 - 50 cm 1 integrated appliance aperture 88 cm 1 door 90.6 cm	36,2-50,0 88,0	<b>GOI 60 14 55 11X</b>	R/L	▲	407	421	481	570	608	639	702	772	-
							 <i>Important: Observe the appliance manufacturers' permitted front weights for fixed door assembly. See overview of models for front weights.</i>								
906 516		<b>Appliance unit</b> 1 integrated appliance aperture 88 cm 1 door 90.6 cm 1 door 51.6 cm 1 adjustable shelf	88,0	<b>GI 60 14 55 30 X</b>	R/L	▲	417	435	492	587	625	658	721	793	-
							 <i>Important: Observe the appliance manufacturers' permitted front weights for fixed door assembly. See overview of models for front weights.</i>								
906 256		<b>Appliance unit</b> 1 integrated appliance aperture 88 cm 1 door 90.6 cm 2 pull-outs 25.6 cm	88,0	<b>GI 60 14 55 30 X1</b>	R/L	▲	681	700	737	801	842	883	933	1026	-
							 <i>Important: Observe the appliance manufacturers' permitted front weights for fixed door assembly. See overview of models for front weights.</i>								
		<b>Appliance unit with integrated ventilation</b>		<b>GIB 60 14 55 30 X1</b>	R/L	▲	697	717	754	817	859	900	950	1045	-
1166 256		<b>Appliance unit</b> 1 integrated appliance aperture 103 cm 1 door 116.6 cm 1 pull-out 25.6 cm	103,0	<b>GI 60 14 55 40 X</b>	R/L	▲	506	531	604	802	862	909	996	1096	-
							 <i>Important: Observe the appliance manufacturers' permitted front weights for fixed door assembly. See overview of models for front weights.</i>								
		<b>Appliance unit with integrated ventilation</b>		<b>GIB 60 14 55 40 X</b>	R/L	▲	523	548	621	818	879	926	1013	1114	-



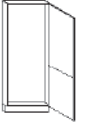
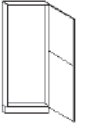
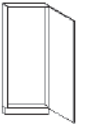
## Tall units 143 cm high for refrigerator/freezer

Carcase depth 55.5 cm (standard)

▲ = Types also available with 61 cm carcass depth (order no. ... replace ... 55 ... with 61)


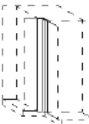


		Order no.				Price groups									
		W H D		Hinge side:	Carcass depth	1	2	3	4	5	6	7	8	9	
646 776		<b>Appliance unit with integrated ventilation</b> 1 integrated appliance aperture 122.5 cm 1 door 64.6 cm attached to 1 door 77.6 cm	122,5	R/L ▲	▲	<b>GIB 60 14 55 50 X5V</b>	434	449	508	605	643	676	737	811	-
						 <i>Important: Observe the appliance manufacturers' permitted front weights for fixed door assembly. See overview of models for front weights.</i>									
			78												
1426		<b>Appliance unit</b> 1 integrated appliance aperture 122.5 cm 1 door 142.6 cm	122,5	R/L ▲	▲	<b>GI 60 14 55 50 X</b>	423	444	519	660	750	796	873	960	-
						 <i>Important: Observe the appliance manufacturers' permitted front weights for fixed door assembly. See overview of models for front weights.</i>									
						<b>GIB 60 14 55 50 X</b>	440	462	536	677	769	813	893	982	-
386 1036		<b>Appliance unit</b> 1 integrated appliance aperture 122.5 cm 1 door 38.6 cm 1 door 103.6 cm	122,5	R/L ▲	▲	<b>GI 60 14 55 55 0X</b>	417	435	492	587	625	658	728	801	-
						 <i>Important: Observe the appliance manufacturers' permitted front weights for fixed door assembly. See overview of models for front weights.</i>									
						<b>GIB 60 14 55 55 0X</b>	434	449	508	605	643	676	745	820	-
1426		<b>Appliance unit</b> 1 integrated appliance aperture 140 cm 1 door 142.6 cm	140,0	R/L ▲	▲	<b>GI 60 14 55 62 04</b>	495	517	589	731	823	865	946	1041	-
						 <i>Note: Structural metal shelf at bottom Important: Observe the appliance manufacturers' permitted front weights for fixed door assembly. See overview of models for front weights.</i>									

## spacefitter frame 143 cm high

		Order no.				Price groups									
		W H D		Hinge side:	Carcass depth	1	2	3	4	5	6	7	8	9	
776 646		<b>Tall unit spacefitter frame</b> 1 door 77.6 cm connected to 1 door 64.6 cm Carcass depth 10 cm For recess cladding		R/L	R/L	<b>GPR 30 14 10 02</b>	230	239	275	359	370	391	435	479	-
						<b>GPR 40 14 10 02</b>	230	239	275	359	370	391	435	479	-
						<b>GPR 45 14 10 02</b>	230	239	275	359	370	391	435	479	-
						<b>GPR 50 14 10 02</b>	230	239	275	384	400	422	465	512	-
						<b>GPR 60 14 10 02</b>	258	268	308	448	477	498	549	604	-
646 776		<b>Tall unit spacefitter frame</b> 1 door 64.6 cm connected to 1 door 77.6 cm Carcass depth 10 cm For recess cladding	78	R/L	R/L	<b>GPR 30 14 10 01</b>	230	239	275	359	370	391	435	479	-
						<b>GPR 40 14 10 01</b>	230	239	275	359	370	391	435	479	-
						<b>GPR 45 14 10 01</b>	230	239	275	359	370	391	435	479	-
						<b>GPR 50 14 10 01</b>	230	239	275	384	400	422	465	512	-
						<b>GPR 60 14 10 01</b>	258	268	308	448	477	498	549	604	-
1426		<b>Tall unit spacefitter frame</b> 1 door 142.6 cm Carcass depth 10 cm For recess cladding		R/L	R/L	<b>GPR 30 14 10</b>	230	239	275	359	370	391	435	479	-
						<b>GPR 45 14 10</b>	230	239	275	359	370	391	435	479	-
						<b>GPR 50 14 10</b>	230	239	275	384	400	422	465	512	-
						<b>GPR 60 14 10</b>	258	268	308	448	477	498	549	604	-

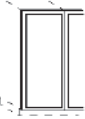


## Front filler 143 cm high

Carcass depth 55.5 cm (standard)


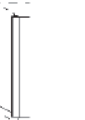
	<b>Tall unit front filler</b> one-part, 143 cm high 3.5 - 10 cm 10.1 - 20 cm	<b>GP 10 14</b>	84	84	91	141	141	141	149	164	-
		<b>GP 20 14</b>	91	91	105	167	167	167	180	198	-
	<b>Tall unit corner filler 90°</b> 143 cm high as corner connection between 2 tall units Without shelf, 9.5 x 9.5 cm	<b>GPW 90 14</b>	123	123	136	194	194	194	211	232	-
	<b>Tall unit corner filler 135°</b> 143 cm high For cladding blind corners Planning dimensions 25.9 x 25.9 cm	<b>GPW 135 14</b>	123	123	136	194	194	194	211	232	-
		 <i>Not available for: ALU TEC RP</i>									

## Back cladding 143 cm high with screw-fitted fronts

Carcase depth 55.5 cm (standard)

		Order no. W H D		Hinge side: Carcase depth	Price groups								
					1	2	3	4	5	6	7	8	9
1426 	<b>Back cladding</b> For tall units, 143 cm high Carcase material with screw-fitted fronts 142.6 cm Only available in grid sizes	per 10 cm Width											
		<b>GVF 14</b>			65	68	71	89	91	95	101	111	-
646 776 	<b>Back cladding</b> For tall units, 143 cm high Carcase material with screw-fitted fronts 1 front 64.6 cm attached to 1 front 77.6 cm Only available in grid sizes	per 10 cm Width		78									
		<b>GVF 14 01</b>				65	68	71	89	91	95	101	111
776 646 	<b>Back cladding</b> For tall units, 143 cm high Carcase material with screw-fitted fronts 1 front 77.6 cm attached to 1 front 64.6 cm Only available in grid sizes	per 10 cm Width											
		<b>GVF 14 02</b>			65	68	71	89	91	95	101	111	-

## Back cladding 143 cm high

		Order no. W H D		Hinge side: Carcase depth	Decor groups								
					M10	M20	M30	M40	M50	M60	M70	M80	M90
	<b>Back cladding</b> For tall units, 143 cm high 16 mm thick	per 10 cm Width											
		<b>GVK 14</b>			26	45	52	69	69	69	69	69	-
	<b>Tall unit background filler</b> Width: 20 cm For fitting flush with carcass 143 cm high												
		<b>GPSL 00 14</b>			45	53	75	100	100	100	100	100	-

M 10	M 20	M 30	M 40	M 50
K M10 laminate	D M20 Laminate decor	I M30 RESOPAL PRO super matt IH M30 HPL PRO PW M30 PRIMEWOOD/Basic Veneer	A M40 DIRECTLACK matt L M40 DIRECTLACK high-gloss	B M50 Velvet lacquer S M50 microstructure lacquer
M 60	M 70	M 80	M 90	
QH M60 SMARTGLAS high-gloss QM M60 SMARTGLAS satin-finish	F M70 veneer / oak / walnut Z M70 Veneer / Bavaria	C1 M80 FENIX stainless-steel look H M80 high gloss-Lacquer MP M80 laqué mat Premium		



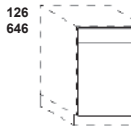
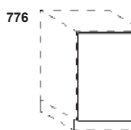
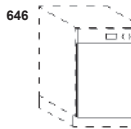
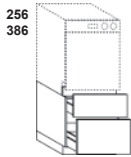
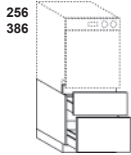
# Dishwasher surround 143 cm high

Carcase depth 55.5 cm (standard)

▲ = Types also available with 61 cm carcass depth (order no. ... replace ... 55 ... with 61)

Order no.  
W H D

Hinge side:	Carcass depth	Price groups									
		1	2	3	4	5	6	7	8	9	
▲	55.5	<b>UGS 45 14 55 87</b>	426	436	485	536	536	559	608	669	-
		<b>UGS 60 14 55 87</b>	461	471	517	582	582	615	666	733	-
		<b>Not available for:</b>									
		ALU TEC RP									
		Important! Plan free-standing with 25 mm panels, planning dimension 65 cm									
▲	55.5	<b>UGV 60 14 55 87</b>	461	472	517	582	582	615	666	733	-
		Important! Plan free-standing with 25 mm panels, planning dimension 65 cm									
	61	<b>UT 45 65</b>	96	100	108	120	186	207	244	268	-
		<b>UT 60 65 2</b>	108	112	122	134	218	236	281	309	-
		Always order article DL 60 6 if a high-volume dishwasher has not been included in planning!									
	61	<b>UT 45 78 1</b>	111	116	122	134	204	220	257	283	-
		<b>UT 60 78 1</b>	122	126	138	146	232	253	294	323	-
	61	<b>UTV 45 78</b>	111	116	122	134	204	220	257	283	-
		<b>Extra charge for MP-GSN...</b>	145	145	145	145	145	145	145	145	-
	61	<b>UTV 60 78</b>	122	126	138	146	232	253	294	323	-
		<b>Extra charge for MP-GSN...</b>	148	148	148	148	148	148	148	148	-



**Base for raised dishwasher (86 cm high)**  
with top shelf, 54.5 cm high  
1 drawer  
with pull-out panel 25.6 cm, angled at top,  
1 pull-out 38.6 cm, 45.5 cm deep  
1 collection tray (available only in 60 cm width)  
Overall height 143 cm

**Base for raised dishwasher (86 cm high) with VARIO HINGE**  
with top shelf, 54.5 cm high  
1 drawer  
with pull-out panel 25.6 cm not angled  
1 pull-out 38.6 cm, 45.5 cm deep  
1 collection tray (available only in 60 cm width)  
Overall height 143 cm

**Base unit door, 64.6 cm**  
as front panel for integrated dishwashers 86 cm high  
44.6 cm wide with 45 cm  
59.6 cm wide with 60 cm

**Base unit door, 77.6 cm**  
59.6 cm wide  
As front panel for fully integrated dishwashers 86 cm high and pull-out fridges and freezers  
44.6 cm wide with 45 cm  
59.6 cm wide with 60 cm

**Base unit door, 77.6 cm**  
1 drawer panel 12.6 cm with 1 door 64.6 cm connected  
As front panel for fully integrated dishwashers 86 cm high and pull-out fridges and freezers  
44.6 cm wide with 45 cm  
*Surcharge in connection with the grip rails N700 and N775 incl. connecting plate and additional grip rails*  
59.6 cm wide with 60 cm  
*Surcharge in connection with the grip rails N700 and N775 incl. connecting plate and additional grip rails*

# Raised dishwashers

For carcass height 143 cm, carcass depth 55.5 cm

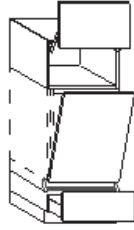
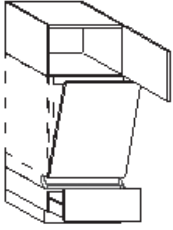
Pull-out panel at bottom 25.6 cm high

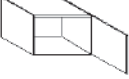
**Note:**

Do not plan at the end of a row. Only plan between tall units.

Always follow the assembly instructions from the appliance manufacturers.

▲ = Types also available with 61 cm carcass depth (order no. ... replace ... 55 ... with 61)




386  **Dresser unit above raised dishwasher**  
Height 40.5 cm  
1 door 38.6 cm  
1 vapour protector

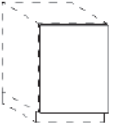
Order no.  
W H D

Hinge side:	Carcass depth	Price groups								
		1	2	3	4	5	6	7	8	9

**A 60 40 55** R/L ▲ 177 184 200 242 261 275 298 328 -


386  **Dresser unit with lifting door for microwave above raised dishwasher**  
Height 40.5 cm  
1 lifting door with front 38.6 cm  
1 vapour protector

**ALT 60 40 55** ▲ 328 333 348 391 395 399 460 506 -


776  **Base unit door, 77.6 cm**  
59.6 cm wide  
As front panel for fully integrated dishwashers 86 cm high and pull-out fridges and freezers  
59.6 cm wide with 60 cm

 Always order article DL 60 6 if a high-volume dishwasher has not been included in planning!

**UT 60 78 1** 122 126 138 146 232 253 294 323 -


 **Spacer strips for fully integrated dishwasher**  
Appliance height 82 cm  
2 spacer strips  
Colour: Art Pepper 6 cm high


**DL 60 6** 32


256  **Base for raised dishwasher (86 cm high)**  
with top shelf, 15.5 cm high  
1 drawer  
with pull-out panel 25.6 cm, 45.5 cm deep angled at top  
1 collection tray (available only in 60 cm width)




**UGS 60 10 55 87** ▲ 276 290 320 378 412 439 480 528 -


 Not available for:  
ALU TEC RP

 Important!  
Plan free-standing with 25 mm panels

256  **Base for raised dishwasher (86 cm high)**  
only for dishwashers with **VARIO HINGE**  
with top shelf, 15.5 cm high  
1 drawer  
with pull-out panel 25.6 cm not angled  
45.5 cm deep  
1 collection tray (available only in 60 cm width)

**UGV 60 10 55 87** ▲ 276 290 320 378 412 439 480 528 -

 Important!  
Plan free-standing with 25 mm panels

 **Vapour protector for raised dishwashers**  
Finish: metal  
to protect the fronts above

**WSB-45** 11

**WSB-60** 12

# 6.2

## Tall units 156 cm

Tall units 156 cm high	XL 6.2.3-XL 6.2.7
Tall units 156 cm high with glass fronts	XL 6.2.7
Additional equipment	XL 6.2.8
Tall units 156 cm high with roller shutter	XL 6.2.8
Appliance unit 156 cm high for microwave / oven	XL 6.2.9
Appliance unit 156 cm high for microwave / oven Double aperture	XL 6.2.10
Appliance unit 156 cm high for microwave / oven Lifting door / aperture	XL 6.2.10
Appliance unit 156 cm high for refrigerator/freezer	XL 6.2.11-XL 6.2.12
spacefitter frame 156 cm high	XL 6.2.12
Front filler 156 cm high	XL 6.2.12-XL 6.2.13
Back cladding 156 cm high with screw-fitted fronts	XL 6.2.13
Back cladding 156 cm high	XL 6.2.13
Visible sides / increased side depth 156 cm high	XL 6.2.14
Shelf units 156 cm high	XL 6.2.14
Dishwasher surround 156 cm high	XL 6.2.14-XL 6.2.15
Raised dishwashers For carcass height 156 cm, carcass depth 55.5 cm	XL 6.2.16
Raised dishwashers For carcass height 156 cm, carcass depth 55.5 cm	XL 6.2.17
Raised dishwashers For carcass height 156 cm, carcass depth 55.5 cm	XL 6.2.18

### Legend:



Available with grip ledge N...



Not available with grip ledge N...



This symbol indicates which models are available



This symbol indicates which models are not available



wall-mounted units



available depths for wall-mounted units



Planning advice



This symbol illustrates which appliance units are delivered with integrated ventilation



Not available with „push-to-open“ fitting



Aperture height specifications



Available carcass depths 34/45.5/55.5/61.0 cm



Available carcass depths 45.5/55.5/61.0 cm



Available carcass depths 55.5/61.0 cm

Height  
156 cm

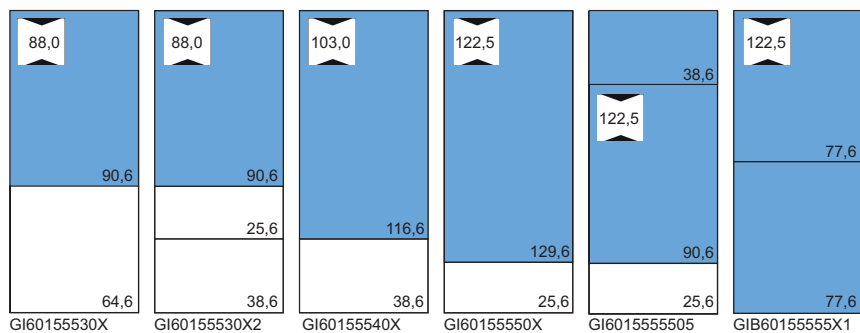
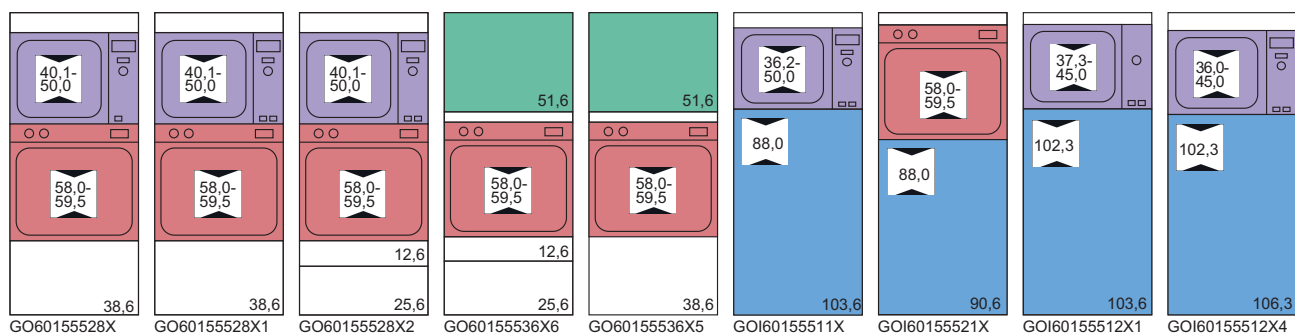
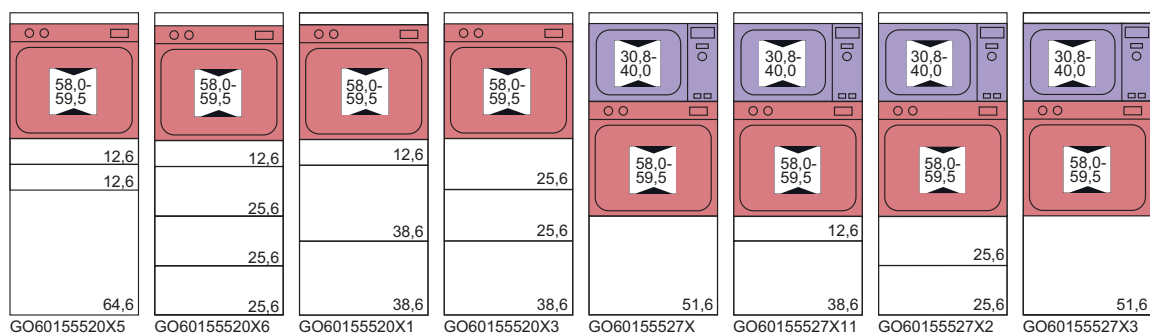
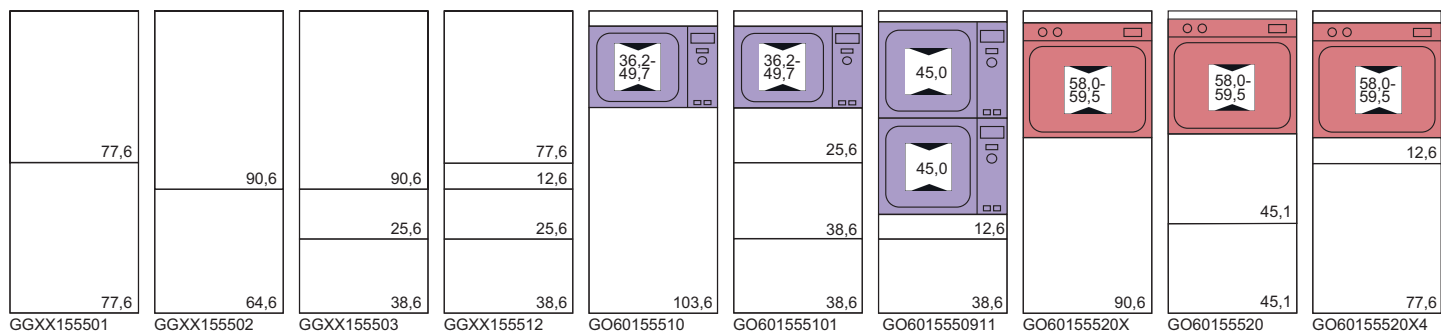


# The most important tall unit types 156 cm high

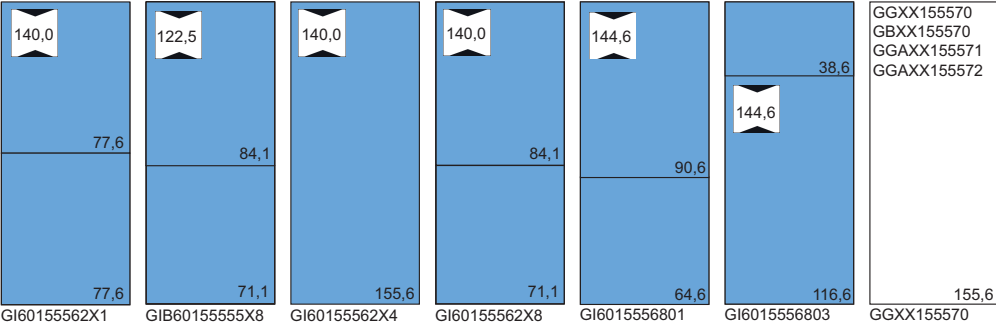
Page XL 6.2.3	Page XL 6.2.3	Page XL 6.2.3	Page XL 6.2.3	Page XL 6.2.3	Page XL 6.2.3	Page XL 6.2.3	Page XL 6.2.3	Page XL 6.2.3
GGs..155502 Unit widths: 25	GGs..155501 Unit widths: 25	GVSTP..155502 Unit widths: 25	GVSTP..155501 Unit widths: 25	GV..155501 Unit widths: 30/45	GV..155570 Unit widths: 30/45	GVP..155501 Unit widths: 30/45	GVP..155570 Unit widths: 30/45	GVP..155501 Unit widths: 50/60
Page XL 6.2.4	Page XL 6.2.4	Page XL 6.2.4	Page XL 6.2.4	Page XL 6.2.4	Page XL 6.2.4	Page XL 6.2.4	Page XL 6.2.4	Page XL 6.2.4
GVP..0155501 Unit widths: 100	GV..155502 Unit widths: 50/60	GV..155501 Unit widths: 50/60	GVPS..1555 Unit widths: 60	GVT..155501 Unit widths: 50/60	GVPT..155501 Unit widths: 50/60	GG..155503 Unit widths: 30/40/45/50/60	GG..155502 Unit widths: 30/40/45/50/60	GG..155506 Unit widths: 30/40/45/50/60
Page XL 6.2.4	Page XL 6.2.4	Page XL 6.2.5	Page XL 6.2.5	Page XL 6.2.5	Page XL 6.2.5	Page XL 6.2.5	Page XL 6.2.5	Page XL 6.2.5
GG..155501 Unit widths: 30/40/45/50/60	GG..155501 Unit widths: 80/90	GGA..155502 Unit widths: 30/40/45/50/60	GGA..155501 Unit widths: 30/40/45/50/60	GGA..155501 Unit widths: 90	GG..155512 Unit widths: 30/40/45/50/60	GG..155505 Unit widths: 30/40/45/50/60	GGA..155506 Unit widths: 30/40/45/50/60	GG..155570 Unit widths: 30/40/45/50/60
Page XL 6.2.5	Page XL 6.2.6	Page XL 6.2.6	Page XL 6.2.6	Page XL 6.2.6	Page XL 6.2.7	Page XL 6.2.7	Page XL 6.2.7	Page XL 6.2.7
GGA..155571 Unit widths: 30/40/45/50/60	GGA..155572 Unit widths: 30/40/45/50/60	GB..155502 Unit widths: 30/40/45/50/60	GB..155501 Unit widths: 30/40/45/50/60	GB..155570 Unit widths: 30/40/45/50/60	GEL..1555 Unit widths: 115/125	GE..155570 Unit widths: 115/125	GEH..155570 Unit widths: 115/125	GGD..155570 Unit widths: 45/50/60
Page XL 6.2.8	Page XL 6.2.12	Page XL 6.2.12	Page XL 6.2.12	Page XL 6.2.13	Page XL 6.2.13	Page XL 6.2.13	Page XL 6.2.13	Page XL 6.2.14
TAB-AZ..55 Unit widths: 45/50/60/80/90	GPR..151002 Unit widths: 30/40/45/50/60	GPR..151001 Unit widths: 30/40/45/50/60	GP..15 Unit widths: 3,5-20	GPW..15 Unit widths: 9,5x9,5	GPW..15 Unit widths: 25,9x25,9	GVF..02 Unit widths: 10-250	GVF..01 Unit widths: 10-250	GR..1558 Unit widths: 30/40/45/50/60
Page XL 6.2.14	Page XL 6.2.14							
GRA..1558 Unit widths: 25/34	GRA..1558 Unit widths: 25/34							



# Recess overview Tall units 156 cm



# Recess overview Tall units 156 cm




# Tall units 156 cm high

Carcase depth 55.5 cm (standard)

■ = Models also available in 34/45.5/61 cm carcass depth (Order no.: ... replace ... 55 ... with 34/45/61)  
 □ = Models also available in 45.5/61 cm carcass depth (order no.: replace ... 55 ... with 45/61)  
 ▲ = Types also available with 61 cm carcass depth (order no.: ... replace ... 55 ... with 61)

Order no.  
W H D


Hinge side:	Carcass depth	Price groups								
		1	2	3	4	5	6	7	8	9
R/L	■	508	527	573	653	705	735	794	873	-
R/L	■	508	527	573	653	705	735	794	873	-
R/L	▲	1233	1254	1302	1364	1417	1445	1504	1654	-
R/L	▲	1233	1254	1302	1364	1417	1445	1504	1654	-
	▲	861	887	908	1037	1087	1133	1219	1341	-
	▲	885	911	936	1071	1129	1176	1272	1399	-
	▲	861	887	908	1037	1087	1133	1219	1341	-
	▲	885	911	936	1071	1129	1176	1272	1399	-
	▲	943	969	989	1117	1168	1214	1299	1429	-
	▲	967	991	1019	1151	1208	1256	1352	1487	-
Not available for: CASTELLO, FRAME, MUNICH, NEVADA, VINO, VIVA										
	▲	986	1013	1036	1159	1208	1255	1341	1475	-
	▲	1021	1047	1073	1202	1259	1309	1403	1543	-
	▲	986	1013	1036	1159	1208	1255	1341	1475	-
	▲	1021	1047	1073	1202	1259	1309	1403	1543	-
	▲	1067	1094	1114	1240	1290	1337	1420	1562	-
	▲	1102	1130	1153	1283	1341	1390	1485	1634	-
Not available for: CASTELLO, FRAME, MUNICH, NEVADA, VINO, VIVA										
R/L	▲	1711	1727	1778	1876	1921	1953	2010	2211	-
R/L	▲	1765	1787	1841	1989	2045	2079	2151	2366	-

906 646  **Crockery cupboard angled 37.2°**  
 1 door 90.6 cm  
 1 door 64.6 cm  
 5 adjustable shelves  
 For adjacent fitting left or right


Ill. left

776 776  **Crockery cupboard angled 37.2°**  
 2 doors 77.6 cm  
 1 fixed shelf  
 4 adjustable shelves  
 For adjacent fitting left or right


Ill. left


906 646  **Larder unit angled 37.2°**  
 1 door 90.6 cm connected to 1 door 64.6 cm  
 1 pull-out element  
 4 adjustable wooden shelves with chrome-plated square rail  
 For adjacent fitting left or right


Ill. left


776 776  **Larder unit angled 37.2°**  
 2 doors 77.6 cm  
 1 pull-out element  
 4 adjustable wooden shelves with chrome-plated square rail  
 For adjacent fitting left or right


Ill. left


906 646  **Larder unit**  
 1 pull-out  
 1 door 90.6 cm connected to 1 door 64.6 cm  
 on telescopic rails, full height can be pulled out  
 With 4 adjustable wire baskets (chrome-plated)  
 Open top compartment 11.0 cm


776 776  **Larder unit**  
 1 pull-out, 2 connected doors 77.6 cm  
 on telescopic rails, full height can be pulled out  
 With 4 adjustable wire baskets (chrome-plated)  
 Open top compartment 11.0 cm

1556  **Larder unit**  
 1 pull-out 155.6 cm  
 on telescopic rails, full height can be pulled out  
 With 4 adjustable wire baskets (chrome-plated)  
 Open top compartment 11.0 cm

906 646  **Larder unit**  
 1 pull-out  
 1 door 90.6 cm connected to 1 door 64.6 cm  
 on telescopic rails, full height can be pulled out  
 With 4 adjustable wooden shelves with chrome-plated, square rail  
 Open top compartment 11.0 cm

776 776  **Larder unit**  
 1 pull-out, 2 connected doors 77.6 cm  
 on telescopic rails, full height can be pulled out  
 With 4 adjustable wooden shelves with chrome-plated, square rail  
 Open top compartment 11.0 cm

1556  **Larder unit**  
 1 pull-out 155.6 cm  
 on telescopic rails, full height can be pulled out  
 With 4 adjustable wooden shelves with chrome-plated, square rail  
 Open top compartment 11.0 cm

776 776  **Larder unit**  
 1 door 77.6 cm connected to 1 door 77.6 cm  
 1 fixed shelf  
 1 swivel and pull-out element  
 4 adjustable and  
 4 adjustable wooden shelves with chrome-plated square rail  
 Open top compartment 19.1 cm

# Tall units 156 cm high

Carcase depth 55.5 cm (standard)

■ = Models also available in 34/45.5/61 cm carcass depth (Order no.: ... replace ... 55 ... with 34/45/61)  
 □ = Models also available in 45.5/61 cm carcass depth (order no.: replace ... 55 ... with 45/61)  
 ▲ = Types also available with 61 cm carcass depth (order no. ... replace ... 55 ... with 61)

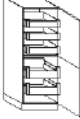
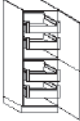



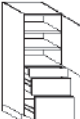



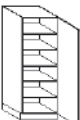
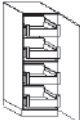

Order no.  
 W H D

Hinge side:	Carcass depth	Price groups									
		1	2	3	4	5	6	7	8	9	
▲	78	<b>GVP 100 15 55 01</b>	3409	3442	3544	3741	3827	3890	4009	4410	-
R/L ▲		<b>GV 50 15 55 02</b>	1454	1468	1520	1624	1670	1702	1760	1936	-
R/L ▲		<b>GV 60 15 55 02</b>	1502	1522	1577	1732	1787	1823	1892	2081	-
R/L ▲	78	<b>GV 50 15 55 01</b>	1454	1468	1520	1624	1670	1702	1760	1936	-
R/L ▲		<b>GV 60 15 55 01</b>	1502	1522	1577	1732	1787	1823	1892	2081	-
R/L ▲	78	<b>GVPS 60 15 55</b>	1271	1287	1343	1503	1558	1593	1664	1830	-
R/L ▲	78	<b>GVT 50 15 55 01</b>	762	774	827	959	1003	1035	1094	1203	-
R/L ▲		<b>GVT 60 15 55 01</b>	818	833	893	1072	1129	1160	1232	1355	-
💡 The adjustable shelves will be delivered as a separate package.											
R/L ▲	78	<b>GVPT 50 15 55 01</b>	795	808	860	993	1038	1068	1129	1242	-
R/L ▲		<b>GVPT 60 15 55 01</b>	852	866	925	1107	1162	1196	1268	1395	-
💡 The adjustable shelves will be delivered as a separate package.											
R/L ■	78	<b>GG 30 15 55 03</b>	658	674	723	807	859	889	950	1045	-
R/L ■		<b>GG 40 15 55 03</b>	658	674	723	807	859	889	950	1045	-
R/L ■		<b>GG 45 15 55 03</b>	658	674	723	807	859	889	950	1045	-
R/L ■		<b>GG 50 15 55 03</b>	658	674	723	856	901	931	991	1090	-
R/L ■		<b>GG 60 15 55 03</b>	699	713	772	953	1009	1042	1113	1224	-
R/L ■	78	<b>GG 30 15 55 02</b>	328	341	392	477	528	557	618	680	-
R/L ■		<b>GG 40 15 55 02</b>	328	341	392	477	528	557	618	680	-
R/L ■		<b>GG 45 15 55 02</b>	328	341	392	477	528	557	618	680	-
R/L ■		<b>GG 50 15 55 02</b>	328	341	392	526	569	601	660	726	-
R/L ■		<b>GG 60 15 55 02</b>	367	381	440	621	677	710	782	860	-
R/L ■	71,5	<b>GG 30 15 55 06</b>	658	674	723	807	859	889	950	1045	-
R/L ■		<b>GG 40 15 55 06</b>	658	674	723	807	859	889	950	1045	-
R/L ■		<b>GG 45 15 55 06</b>	658	674	723	807	859	889	950	1045	-
R/L ■		<b>GG 50 15 55 06</b>	658	674	723	856	901	931	991	1090	-
R/L ■		<b>GG 60 15 55 06</b>	699	713	772	953	1009	1042	1113	1224	-
✂ Not available for: MIAMI, VIVA											
R/L ■	78	<b>GG 30 15 55 01</b>	328	341	392	477	528	557	618	680	-
R/L ■		<b>GG 40 15 55 01</b>	328	341	392	477	528	557	618	680	-
R/L ■		<b>GG 45 15 55 01</b>	328	341	392	477	528	557	618	680	-
R/L ■		<b>GG 50 15 55 01</b>	328	341	392	526	569	601	660	726	-
R/L ■		<b>GG 60 15 55 01</b>	367	381	440	621	677	710	782	860	-
■	78	<b>GG 80 15 55 01</b>	710	737	841	997	1064	1115	1229	1352	-
■		<b>GG 90 15 55 01</b>	710	737	841	997	1064	1115	1229	1352	-

# Tall units 156 cm high

Carcase depth 55.5 cm (standard)

■ = Models also available in 34/45.5/61 cm carcass depth (Order no.: ... replace ... 55 ... with 34/45/61)  
 □ = Models also available in 45.5/61 cm carcass depth (order no.: replace ... 55 ... with 45/61)  
 ▲ = Types also available with 61 cm carcass depth (order no.: ... replace ... 55 ... with 61)

						Price groups									
		Order no.		Hinge side:	Carcass depth	1	2	3	4	5	6	7	8	9	
		W	H	D											
776 	<b>Larder unit</b> 1 door 77.6 cm with wide angle hinges 3 internal drawers 1 fixed shelf 1 door 77.6 cm with wide angle hinges 2 internal pull-outs	78	GGA 30 15 55 02	R/L	■	970	982	1032	1101	1152	1183	1244	1368	-	
			GGA 40 15 55 02	R/L	■	1001	1013	1064	1131	1183	1213	1274	1401	-	
			GGA 45 15 55 02	R/L	■	1010	1021	1072	1138	1190	1221	1282	1410	-	
			GGA 50 15 55 02	R/L	■	1024	1036	1087	1203	1249	1278	1340	1474	-	
			GGA 60 15 55 02	R/L	■	1083	1098	1154	1321	1378	1410	1481	1629	-	
<b>Planning advice:</b> Take account of opening angle															
776 	<b>Larder unit</b> 1 door 77.6 cm with wide angle hinges 2 internal pull-outs 1 fixed shelf 1 door 77.6 cm with wide angle hinges 2 internal pull-outs	78	GGA 30 15 55 01	R/L	■	962	973	1024	1092	1144	1174	1235	1359	-	
			GGA 40 15 55 01	R/L	■	990	1004	1055	1121	1174	1203	1267	1394	-	
			GGA 45 15 55 01	R/L	■	1002	1014	1065	1132	1184	1214	1275	1403	-	
			GGA 50 15 55 01	R/L	■	1017	1028	1079	1196	1240	1272	1333	1466	-	
			GGA 60 15 55 01	R/L	■	1074	1090	1147	1312	1366	1401	1472	1619	-	
<b>Planning advice:</b> Take account of opening angle		 <b>Planning advice:</b> Doors with wide angle hinges may not be planned alongside units or panels if the protrusion to the front of the adjoining article is greater than 3 cm (hinge side). Doors with wide angle hinges protrude over the carcass side.													
776 	<b>Crockery cupboard</b> 2 doors 77.6 cm with wide angle hinges 2 doors 77.6 cm with wide angle hinges 2 internal pull-outs 1 fixed shelf 2 internal pull-outs	78	GGA 90 15 55 01		■	1583	1607	1709	1853	1959	2017	2140	2354	-	
			 <b>Planning advice:</b> Doors with wide angle hinges may not be planned alongside units or panels if the protrusion to the front of the adjoining article is greater than 3 cm (hinge side). Doors with wide angle hinges protrude over the carcass side.												
776 126 256 386 	<b>Crockery cupboard</b> 1 door 77.6 cm 2 adjustable shelves 1 drawer 12.6 cm 1 pull-out 25.6 cm 1 pull-out 38.6 cm	78	GG 30 15 55 12	R/L	■	803	816	866	951	1004	1032	1094	1203	-	
			GG 40 15 55 12	R/L	■	803	816	866	951	1004	1032	1094	1203	-	
			GG 45 15 55 12	R/L	■	803	816	866	951	1004	1032	1094	1203	-	
			GG 50 15 55 12	R/L	■	803	816	866	1002	1044	1075	1136	1250	-	
			GG 60 15 55 12	R/L	■	843	858	916	1096	1151	1186	1257	1383	-	
711 841 	<b>Crockery cupboard</b> 1 door 71.1 cm 1 door 84.1 cm 1 fixed shelf 4 adjustable shelves	84,5	GG 30 15 55 05	R/L	■	328	341	392	477	528	557	618	680	-	
			GG 40 15 55 05	R/L	■	328	341	392	477	528	557	618	680	-	
			GG 45 15 55 05	R/L	■	328	341	392	477	528	557	618	680	-	
			GG 50 15 55 05	R/L	■	328	341	392	526	569	601	660	726	-	
			GG 60 15 55 05	R/L	■	367	381	440	621	677	710	782	860	-	
<b>Not available for:</b> MIAMI, VIVA															
711 841 	<b>Larder unit</b> 1 door 71.1 cm with wide angle hinges 2 internal pull-outs 1 fixed shelf 1 door 84.1 cm with wide angle hinges 2 internal pull-outs	84,5	GGA 30 15 55 06	R/L	■	962	973	1024	1092	1144	1174	1235	1359	-	
			GGA 40 15 55 06	R/L	■	990	1004	1055	1121	1174	1203	1267	1394	-	
			GGA 45 15 55 06	R/L	■	1002	1014	1065	1132	1184	1214	1275	1403	-	
			GGA 50 15 55 06	R/L	■	1017	1028	1079	1196	1240	1272	1333	1466	-	
			GGA 60 15 55 06	R/L	■	1074	1090	1147	1312	1366	1401	1472	1619	-	
<b>Not available for:</b> MIAMI, VIVA															
<b>Planning advice:</b> Take account of opening angle		 <b>Planning advice:</b> Doors with wide angle hinges may not be planned alongside units or panels if the protrusion to the front of the adjoining article is greater than 3 cm (hinge side). Doors with wide angle hinges protrude over the carcass side.													
1556 	<b>Crockery cupboard</b> 1 door 155.6 cm 1 fixed shelf 4 adjustable shelves	N/A	GG 30 15 55 70	R/L	■	410	422	474	557	608	639	700	770	-	
			GG 40 15 55 70	R/L	■	410	422	474	557	608	639	700	770	-	
			GG 45 15 55 70	R/L	■	410	422	474	557	608	639	700	770	-	
			GG 50 15 55 70	R/L	■	410	422	474	606	650	682	742	816	-	
			GG 60 15 55 70	R/L	■	446	464	523	702	759	791	862	948	-	
<b>Not available for:</b> CASTELLO, FRAME, MUNICH, NEVADA, VINO, VIVA															
<b>Each front has a tightening fitting</b> Ranges without fitting: SMARTGLAS, NOBEL, SOFIE, YORK, LUGANO, TALEA, RIVA, GARDA, ATLANTA, ORLANDO, CHICAGO without tightening fitting															
1556 	<b>Larder unit</b> 1 door 155.6 cm with wide angle hinges 2 internal pull-outs 1 fixed shelf 2 internal pull-outs	N/A	GGA 30 15 55 71	R/L	■	1042	1055	1106	1174	1225	1255	1317	1449	-	
			GGA 40 15 55 71	R/L	■	1072	1084	1135	1202	1255	1284	1346	1481	-	
			GGA 45 15 55 71	R/L	■	1082	1095	1145	1213	1266	1294	1356	1492	-	
			GGA 50 15 55 71	R/L	■	1097	1110	1160	1276	1322	1352	1413	1554	-	
			GGA 60 15 55 71	R/L	■	1154	1172	1227	1393	1449	1482	1554	1709	-	
<b>Not available for:</b> CASTELLO, FRAME, MUNICH, NEVADA, VINO, VIVA															
<b>Planning advice:</b> Take account of opening angle		 <b>Planning advice:</b> Each front has a tightening fitting Ranges without fitting: SMARTGLAS, NOBEL, SOFIE, YORK, LUGANO, TALEA, RIVA, GARDA, ATLANTA, ORLANDO, CHICAGO without tightening fitting Doors with wide angle hinges may not be planned alongside units or panels if the protrusion to the front of the adjoining article is greater than 3 cm (hinge side). Doors with wide angle hinges protrude over the carcass side.													



# Tall units 156 cm high

Carcase depth 55.5 cm (standard)

■ = Models also available in 34/45.5/61 cm carcass depth (Order no.: ... replace ... 55 ... with 34/45/61)  
 □ = Models also available in 45.5/61 cm carcass depth (order no.: replace ... 55 ... with 45/61)  
 ▲ = Types also available with 61 cm carcass depth (order no. ... replace ... 55 ... with 61)

Order no.  
W H D

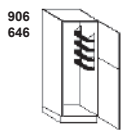
Hinge side:	Carcass depth	Price groups									
		1	2	3	4	5	6	7	8	9	
R/L ■	55.5	GGA 30 15 55 72	1050	1064	1113	1183	1233	1264	1325	1458	-
		GGA 40 15 55 72	1080	1094	1144	1212	1264	1293	1355	1491	-
		GGA 45 15 55 72	1090	1102	1152	1220	1272	1302	1363	1499	-
		GGA 50 15 55 72	1106	1116	1168	1284	1329	1359	1419	1561	-
		GGA 60 15 55 72	1165	1180	1236	1401	1458	1491	1561	1717	-
Not available for: CASTELLO, FRAME, MUNICH, NEVADA, VINO, VIVA											
Planning advice: Each front has a tightening fitting Ranges without fitting: SMARTGLAS, NOBEL, SOFIE, YORK, LUGANO, TALEA, RIVA, GARDA, ATLANTA, ORLANDO, CHICAGO without tightening fitting Doors with wide angle hinges may not be planned alongside units or panels if the protrusion to the front of the adjoining article is greater than 3 cm (hinge side). Doors with wide angle hinges protrude over the carcass side.											
R/L □	55.5	GB 30 15 55 02	328	341	392	477	528	557	618	680	-
		GB 40 15 55 02	328	341	392	477	528	557	618	680	-
		GB 45 15 55 02	328	341	392	477	528	557	618	680	-
		GB 50 15 55 02	328	341	392	526	569	601	660	726	-
		GB 60 15 55 02	367	381	440	621	677	710	782	860	-
R/L □	55.5	GB 30 15 55 01	328	341	392	477	528	557	618	680	-
		GB 40 15 55 01	328	341	392	477	528	557	618	680	-
		GB 45 15 55 01	328	341	392	477	528	557	618	680	-
		GB 50 15 55 01	328	341	392	526	569	601	660	726	-
		GB 60 15 55 01	367	381	440	621	677	710	782	860	-
R/L □	55.5	GB 30 15 55 70	410	422	474	557	608	639	700	770	-
		GB 40 15 55 70	410	422	474	557	608	639	700	770	-
		GB 45 15 55 70	410	422	474	557	608	639	700	770	-
		GB 50 15 55 70	410	422	474	606	650	682	742	816	-
		GB 60 15 55 70	446	464	523	702	759	791	862	948	-
Not available for: CASTELLO, FRAME, MUNICH, NEVADA, VINO, VIVA											
Each front has a tightening fitting Ranges without fitting: SMARTGLAS, NOBEL, SOFIE, YORK, LUGANO, TALEA, RIVA, GARDA, ATLANTA, ORLANDO, CHICAGO without tightening fitting											
R/L ▲	55.5	GB 40 15 55 12	514	528	579	664	714	743	805	886	-
		GB 45 15 55 12	514	528	579	664	714	743	805	886	-
		GB 50 15 55 12	514	528	579	712	756	788	847	932	-
		GB 60 15 55 12	553	568	626	808	864	897	969	1066	-
		Optional accessories HW HS Holder for vacuum cleaner hose or PET storage pocket (for screwing on), anthracite HW UTB Utensils box, e.g. for storing towels, cleaning cloths, etc. (for screwing on), anthracite									
R/L ▲	55.5	GB 40 15 55 11	514	528	579	664	714	743	805	886	-
		GB 45 15 55 11	514	528	579	664	714	743	805	886	-
		GB 50 15 55 11	514	528	579	712	756	788	847	932	-
		GB 60 15 55 11	553	568	626	808	864	897	969	1066	-
		Optional accessories HW HS Holder for vacuum cleaner hose or PET storage pocket (for screwing on), anthracite HW UTB Utensils box, e.g. for storing towels, cleaning cloths, etc. (for screwing on), anthracite									
R/L ▲	55.5	GB 40 15 55 71	597	608	661	743	795	826	886	975	-
		GB 45 15 55 71	597	608	661	743	795	826	886	975	-
		GB 50 15 55 71	597	608	661	793	836	869	929	1022	-
		GB 60 15 55 71	633	651	744	888	946	977	1048	1153	-
		Not available for: CASTELLO, FRAME, MUNICH, NEVADA, VINO, VIVA									
Optional accessories HW HS Holder for vacuum cleaner hose or PET storage pocket (for screwing on), anthracite HW UTB Utensils box, e.g. for storing towels, cleaning cloths, etc. (for screwing on), anthracite Each front has a tightening fitting Ranges without fitting: SMARTGLAS, NOBEL, SOFIE, YORK, LUGANO, TALEA, RIVA, GARDA, ATLANTA, ORLANDO, CHICAGO without tightening fitting											



**Larder unit**  
 1 door 155.6 cm with wide angle hinges  
 3 internal drawers  
 1 fixed shelf  
 2 internal pull-outs



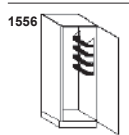
**Planning advice:**  
 Take account of opening angle



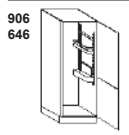
**Broom cupboard**  
 1 door 90.6 cm connected to 1 door 64.6 cm  
 1 hook rail  
 1 storage basket



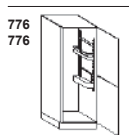
**Broom cupboard**  
 1 door 77.6 cm connected to 1 door 77.6 cm  
 1 hook rail  
 1 storage basket



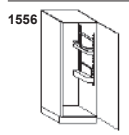
**Broom cupboard**  
 1 door 155.6 cm  
 1 hook rail  
 1 storage basket



**Broom cupboard**  
 1 door 90.6 cm connected to 1 door 64.6 cm  
 1 hook rail with 5 hooks, anthracite  
 Modular interior partitioning system, consisting of:  
 1 set of attachment rails, anthracite  
 1 large 3-side tray with rail, anthracite  
 1 carrier box for cleaning materials with carrier rails, anthracite  
 1 hook rail with 5 hooks, anthracite



**Broom cupboard**  
 1 door 77.6 cm connected to 1 door 77.6 cm  
 1 hook rail with 5 hooks, anthracite  
 Modular interior partitioning system, consisting of:  
 1 set of attachment rails, anthracite  
 1 large 3-side tray with rail, anthracite  
 1 carrier box for cleaning materials with carrier rails, anthracite  
 1 hook rail with 5 hooks, anthracite



**Broom cupboard**  
 1 door 155.6 cm  
 1 hook rail with 5 hooks, anthracite  
 Modular interior partitioning system, consisting of:  
 1 set of attachment rails, anthracite  
 1 large 3-side tray with rail, anthracite  
 1 carrier box for cleaning materials with carrier rails, anthracite  
 1 hook rail with 5 hooks, anthracite

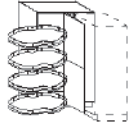
## Tall units 156 cm high

Carcase depth 55.5 cm (standard)

■ = Models also available in 34/45.5/61 cm carcass depth (Order no.: ... replace ... 55 ... with 34/45/61)  
 □ = Models also available in 45.5/61 cm carcass depth (order no.: replace ... 55 ... with 45/61)  
 ▲ = Types also available with 61 cm carcass depth (order no.: ... replace ... 55 ... with 61)


Order no.  
W H D

Hinge side:	Carcass depth	Price groups								
		1	2	3	4	5	6	7	8	9

776 

**„Le Mans“ tall corner unit**  
 Blind section left or right  
 2 doors 77.6 cm, 1 fixed shelf,  
 4 wooden carousel shelves with chrome-plated rail  
 fully swivelling „Le Mans“  
 Carcase width 100 cm with loose corner filler

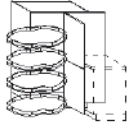
1 door 50 cm, surface area 115-125 x 65 cm  
 1 door 60 cm, surface area 125-130 x 65 cm

78  **Note:** Please allow for shelf turning space and 50 cm clearance for carousel shelves.

Article consists of 2 packages:  
 1. Unit  
 2. Le Mans shelves


**Not available for:**  
 ALU TEC RP

<b>GEL 115 15 55</b>	R/L ▲	1591	1603	1650	1754	1895	1939	2028	2231	-
<b>GEL 125 15 55</b>	R/L ▲	1670	1689	1739	1891	2041	2089	2179	2397	-

776 

**„Le Mans“ tall corner unit with side front panel for height offset**  
 2 doors 77.6 cm, 1 fixed shelf,  
 1 panel in front colour 65cm wide, 155.6 cm high  
 For cladding the corner solution (enclosed)  
 4 wooden carousel shelves with chrome-plated rail  
 fully swivelling „Le Mans“  
 Carcase width 100 cm


1 door 50 cm, surface area 115 x 65 cm  
 1 door 60 cm, surface area 125 x 65 cm

78  **Note:** Please allow for shelf turning space and 50 cm clearance for carousel shelves.

Article consists of 3 packages:  
 1. Unit  
 2. Front cladding, separate  
 3. Le Mans shelves

**Not available for:**  
 ALU TEC RP, ALUELEMENTS, ATLANTA-B, ATLANTA-S, BERGEN, CHALET-B, CHALET-S, FRAME, GENT, LUGANO, LUX-B, MIAMI, NOBEL-B, NOBEL-S, ORLANDO-B, ORLANDO-S, OSLO 15, SOFIE-B, SOFIE-S, STRIP ELEMENTS, TESSIN 15, TIM 15, VILLAGE 15-B, VILLAGE 15-S, VINO, VIVA, YORK-B, YORK-S

<b>GEHL115 15 55</b>	R/L ▲	1662	1703	1764	1913	2087	2158	2278	2506	-
<b>GEHL125 15 55</b>	R/L ▲	1745	1791	1850	2057	2229	2308	2431	2674	-

776 


**Tall corner unit**  
 Blind section left or right  
 2 doors 77.6 cm  
 1 fixed shelf  
 4 adjustable shelves  
 Carcase width 100 cm with loose corner filler

1 door 50 cm, surface area 115-125 x 65 cm  
 1 door 60 cm, surface area 125-130 x 65 cm

78

**Not available for:**  
 ALU TEC RP

<b>GE 115 15 55 70</b>	R/L ▲	722	749	853	1011	1075	1129	1242	1366	-
<b>GE 125 15 55 70</b>	R/L ▲	796	831	934	1147	1217	1272	1392	1531	-

776 

**Tall corner unit**  
 Blind section left or right  
 2 doors 77.6 cm  
 1 fixed shelf  
 4 adjustable shelves  
 Carcase width 100 cm with loose corner filler

1 door 50 cm, surface area 115-125 x 65 cm  
 1 door 60 cm, surface area 125-130 x 65 cm

78

**Not available for:**  
 ALU TEC RP

<b>GE 115 15 55 70</b>	R/L ▲	722	749	853	1011	1075	1129	1242	1366	-
<b>GE 125 15 55 70</b>	R/L ▲	796	831	934	1147	1217	1272	1392	1531	-

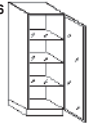
## Tall units 156 cm high with glass fronts

Carcass depth 55.5 cm (standard)

■ = Models also available in 34/45.5/61 cm carcass depth (Order no.: ... replace ... 55 ... with 34/45/61)

Order no.  
W H D

Hinge side:	Carcass depth	Glass groups					
		G1	G2	G2S	G5S	G6	

1556 

**Crockery cupboard with glass front**  
 -neutral-  
 1 glass door 155.6 cm  
 3 adjustable glass shelves  
 and 1 additional adjustable glass shelf  
 for individual positioning

34.0  
45.5  
55.5  
61.0

<b>GGGD 45 15 55 70</b>	R/L ■	-	-	908	1063	1292
<b>GGGD 50 15 55 70</b>	R/L ■	-	-	917	1072	1301
<b>GGGD 60 15 55 70</b>	R/L ■	-	-	967	1131	1351

G 1	G 2	G 2S
<b>G1 AKTIVglass frame</b> 991 Matt glass 992 Translucent black glass	<b>G2 Design front</b> 925 Frame White Agate/Matt glass 935 Premium W. Frame/Matt Glass 940 Macaron Col. Frame/Matt Glass 95 Light grey frame/matt glass 96 Silver Col. Frame/Matt Glass 960 Snow White Frame/Matt Glass 97 Black frame/black glass	<b>G2S aluminium, framed glass door</b> 988 aluminium black, Linea glass 994 Aluminium frame/clear glass 995 aluminium frame/black glass
G 5	G 5S	G 6
	G5S aluminium, door with mullion 996 Alum.frame/clear gl./cross bar	<b>G6 NEW SALON</b> 986 aluminium black, black glass 987 aluminium black, clear glass 989 aluminium matt, bronze-coloured black glass 990 aluminium matt, bronze-coloured clear glass





 = extra charge for wall-mounted units, item: **MP-WST2**

## Additional equipment

				Hinge side:		Carcase depth		Price groups									
		Order no.		W H D				M10	M20	M30	M40	M50	M60	M70	M80	M90	
<b>Surcharge for tall cabinets with glass fronts inside and exterior in the same design</b> available in decor groups: S/B/H/MP/F/Z		IDF-G						-	-	-	-	1646	-	1646	1646	-	
<b>M 10</b>		<b>M 20</b>		<b>M 30</b>		<b>M 40</b>		<b>M 50</b>									
K M10 laminate								B M50 Velvet lacquer S M50 microstructure lacquer									
<b>M 60</b>		<b>M 70</b>		<b>M 80</b>		<b>M 90</b>											
		F M70 veneer / oak / walnut Z M70 Veneer / Bavaria		H M80 high gloss-Lacquer MP M80 laqué mat Premium													

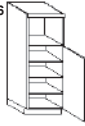

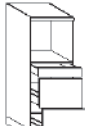
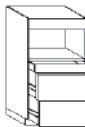

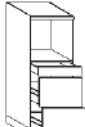
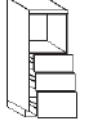
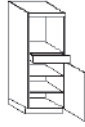

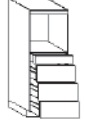
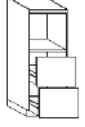
## Tall units 156 cm high with roller shutter

The useable inside depth (bare dimension) for the following carcase depths is  
 36.1 cm – bare dimension 26.5 cm / 47.7 cm – bare dimension 38.1 cm  
 57.7 cm – bare dimension 48.1 cm / 63.2 cm – bare dimension 53.6 cm  
 ▲ = Types also available with 63.2 cm carcase depth (order no. ... replace ... 58 ... with 63)

				Hinge side:		Carcase depth		Decor groups									
		Order no.		W H D				M10	M20	M30	M40	M50	M60	M70	M80	M90	
	<b>Tall unit with roller shutter 156 cm high</b> Roller shutter stainless steel decor 4 adjustable shelves 1 structural shelf 3 sockets	GJG 60 15 58 77		▲		1459		-	-	-	-	3328	-	3922	-	-	
		optional accessory: only TAB-A**45 can be used as a pull-out shelf, and only 577 mm deep No visible sides possible in other decor groups															
<b>as above, but Tall unit with roller shutter 156 cm high 47,7 cm deep</b>		GJG 60 15 48 77				1421		-	-	-	-	3081	-	3594	-	-	
		No visible sides possible in other decor groups															
	<b>Tall unit with roller shutter 156 cm high</b> Roller shutters black laminate 4 adjustable shelves 1 structural shelf 3 sockets	GJG 60 15 58 78		▲		1561		-	-	-	-	3431	-	4026	-	-	
		optional accessory: only TAB-A**45 can be used as a pull-out shelf, and only 577 mm deep No visible sides possible in other decor groups															
<b>as above, but Tall unit with roller shutter 156 cm high 47,7 cm deep</b>		GJG 60 15 48 78				1524		-	-	-	-	3184	-	3697	-	-	
		No visible sides possible in other decor groups															
	<b>Tall unit SMARTGLAS roller shutters 156 cm high 57,7 cm deep</b> 4 adjustable shelves 1 structural shelf 3 sockets	GJS GG 60 15 58		▲		3034		-	-	-	-	4905	-	5498	-	-	
		Panel, guide profile and handle in the same colour as the roller shutter optional accessory: only TAB-A**45 can be used as a pull-out shelf, and only 577 mm deep No visible sides possible in other decor groups															
<b>as above, but Tall unit SMARTGLAS roller shutters 156 cm high 47,7 cm deep</b>		GJS GG 60 15 48				2997		-	-	-	-	4657	-	5170	-	-	
	<b>Pull-out shelf with guide rails</b> With locking function, full pull-out „push to open“, shelf from decor group K For carcase width 45 cm, 50 cm, 60 cm For carcase width 80 cm, 90 cm for carcase depths 45.5 cm and 55.5 cm Load-bearing capacity depth 55.5 cm: 35 kg Load-bearing capacity depth 45.5 cm: 35 kg Load-bearing capacity depth 55.5 cm: 35 kg Load-bearing capacity depth 45.5 cm: 35 kg Load-bearing capacity depth 55.5 cm: 35 kg Load-bearing capacity depth 45.5 cm: 35 kg Load-bearing capacity depth 55.5 cm: 30 kg Load-bearing capacity depth 45.5 cm: 30 kg Load-bearing capacity depth 55.5 cm: 30 kg Load-bearing capacity depth 45.5 cm: 30 kg																
		Important: When installing in units with hinged doors always take wide angle hinges SA-90155E3 into consideration.															
		TAB-AZ45 55				220		-	-	-	-	-	-	-	-	-	
		TAB-AZ45 45				220		-	-	-	-	-	-	-	-	-	
		TAB-AZ50 55				225		-	-	-	-	-	-	-	-	-	
		TAB-AZ50 45				225		-	-	-	-	-	-	-	-	-	
		TAB-AZ60 55				234		-	-	-	-	-	-	-	-	-	
		TAB-AZ60 45				234		-	-	-	-	-	-	-	-	-	
		TAB-AZ80 55				282		-	-	-	-	-	-	-	-	-	
		TAB-AZ80 45				282		-	-	-	-	-	-	-	-	-	
		TAB-AZ90 55				298		-	-	-	-	-	-	-	-	-	
		TAB-AZ90 45				298		-	-	-	-	-	-	-	-	-	
<b>M 10</b>		<b>M 20</b>		<b>M 30</b>		<b>M 40</b>		<b>M 50</b>									
K M10 laminate								B M50 Velvet Lacquer S Microstructur lacquer									
<b>M 60</b>		<b>M 70</b>		<b>M 80</b>		<b>M 90</b>											
		F M70 veneer / oak / walnut Z M70 Veneer / Bavaria															

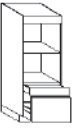
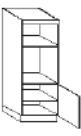


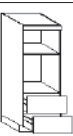
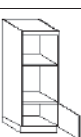


# Appliance unit 156 cm high for microwave / oven

Carcase depth 55.5 cm (standard)

								Price groups								
		Order no.		W H D		Hinge side:	Carcase depth	1	2	3	4	5	6	7	8	9
1036		<b>Appliance unit</b> 1 panel 1 appliance aperture 36.2 - 49.7 cm 1 door 103.6 cm 3 adjustable shelves	36.2-49.7	GO	60 15 55 10	R/L	▲	407	421	481	570	608	639	702	772	-
256 386 386		<b>Appliance unit</b> 1 panel 1 appliance aperture 36.2 - 49.7 cm 1 pull-out 25.6 cm 2 pull-outs 38.6 cm	36.2-49.7	GO	60 15 55 10 1		▲	923	939	997	1088	1128	1154	1220	1342	-
126 451 451		<b>Appliance unit</b> 1 panel 1 appliance aperture 36.2 - 49.7 cm 1 drawer 12.6 cm 2 pull-outs 45.1 cm	36.2-49.7	GO	60 15 55 10 X8		▲	841	854	896	958	1002	1042	1098	1208	-
126 386 386		<b>Appliance unit</b> 1 panel 1 appliance aperture 46 - 59.5 cm 1 drawer 12.6 cm 2 pull-outs 38.6 cm	46.0-59.5 78	GO	90 15 55 10 12		▲	1114	1134	1185	1253	1309	1360	1435	1579	-
906		<b>Appliance unit</b> 1 panel 1 appliance aperture 58.0 - 59.5 cm 1 door 90.6 cm 3 adjustable shelves	58.0-59.5	GO	60 15 55 20 X	R/L	▲	363	375	417	481	524	563	621	683	-
126 386 386		<b>Appliance unit</b> 1 panel 1 appliance aperture 58.0 - 59.5 cm 1 drawer 2 pull-outs 38.6 cm	58.0-59.5 78	GO	60 15 55 20 X1		▲	841	854	896	958	1002	1042	1098	1208	-
256 256 386		<b>Appliance unit</b> 1 panel 1 appliance aperture 58.0 - 59.5 cm 2 pull-outs 25.6 cm 1 pull-out 38.6 cm	58.0-59.5	GO	60 15 55 20 X3		▲	879	896	934	987	1028	1070	1127	1240	-
126 776		<b>Appliance unit</b> 1 panel 1 appliance aperture 58.0 - 59.5 cm 1 drawer 12.6 cm 1 door 77.6 cm 2 adjustable shelves	58.0-59.5 78	GO	60 15 55 20 X4	R/L	▲	448	463	504	568	611	650	708	779	-
126 126 646		<b>Appliance unit</b> 1 panel 1 appliance aperture 58.0 - 59.5 cm 2 drawers 12.6 cm 1 door 64.6 cm 2 adjustable shelves	58.0-59.5	GO	60 15 55 20 X5	R/L	▲	536	550	589	654	697	737	794	873	-
126 256 256 256		<b>Appliance unit</b> 1 panel 1 appliance aperture 58.0 - 59.5 cm 1 drawer 12.6 cm 3 pull-outs 25.6 cm	58.0-59.5	GO	60 15 55 20 X6		▲	967	982	1021	1073	1115	1156	1213	1334	-
451 451		<b>Appliance unit</b> 1 panel 1 appliance aperture 58.0 - 59.5 cm 2 pull-outs 45.1 cm	58.0-59.5	GO	60 15 55 20 X8		▲	640	657	699	752	793	835	886	975	-

## Appliance unit 156 cm high for microwave / oven Double aperture

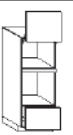



Carcase depth 55.5 cm (standard)

				Order no.				Price groups							
				W H D				1 2 3 4 5 6 7 8 9							
						Hinge side:	Carcase depth								
126 386		<b>Appliance unit</b> 1 panel 1 appliance aperture 45.0 cm 1 appliance aperture 45.0 cm 1 drawer 12.6 cm 1 pull-out 38.6 cm	45,0 45,0	GO	60 15 55 09 11	▲	640	657	699	752	793	835	886	975	-
516		<b>Appliance unit</b> 1 panel 1 appliance aperture 30.8 - 40 cm 1 appliance aperture 58.0 - 59.5 cm 1 door 51.6 cm 1 adjustable shelf	30,8-40,0 58,0-59,5	GO	60 15 55 27 X	R/L ▲	349	368	407	471	508	550	603	663	-
516		<b>Appliance unit</b> 1 panel 1 appliance aperture 30.8 - 40 cm 1 appliance aperture 58.0 - 59.5 cm 1 pull-out 51.6 cm 1 internal drawer	30,8-40,0 58,0-59,5	GO	60 15 55 27 X3	▲	606	625	663	727	771	808	860	946	-
126 386		<b>Appliance unit</b> 1 panel 1 appliance aperture 30.8 - 40 cm 1 appliance aperture 58.0 - 59.5 cm 1 drawer 12.6 cm 1 pull-out 38.6 cm	30,8-40,0 58,0-59,5	GO	60 15 55 27 X11	▲	640	657	699	752	793	835	886	975	-
256 256		<b>Appliance unit</b> 1 panel 1 appliance aperture 30.8 - 40 cm 1 appliance aperture 58.0 - 59.5 cm 2 pull-outs 25.6 cm	30,8-40,0 58,0-59,5	GO	60 15 55 27 X2	▲	640	657	699	752	793	835	886	975	-
386		<b>Appliance unit</b> 1 panel 1 appliance aperture 40.1 - 50.0 cm 1 appliance aperture 58.0 - 59.5 cm 1 door 38.6 cm	40,1-50,0 58,0-59,5	GO	60 15 55 28 X	R/L ▲	349	368	407	471	508	550	603	663	-
386		<b>Appliance unit</b> 1 panel 1 appliance aperture 40.1 - 50.0 cm 1 appliance aperture 58.0 - 59.5 cm 1 pull-out 38.6 cm	40,1-50,0 58,0-59,5	GO	60 15 55 28 X1	▲	496	517	555	615	655	695	746	821	-
126 256		<b>Appliance unit</b> 1 panel 1 appliance aperture 40.1 - 50.0 cm 1 appliance aperture 58.0 - 59.5 cm 1 drawer 12.6 cm 1 pull-out 25.6 cm	40,1-50,0 58,0-59,5	GO	60 15 55 28 X2	▲	643	661	700	764	803	846	898	988	-

## Appliance unit 156 cm high for microwave / oven Lifting door / aperture

Carcase depth 55.5 cm (standard)








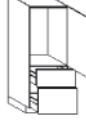

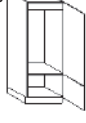



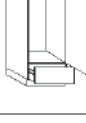



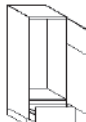
▲ = Types also available with 61 cm carcase depth (order no. ... replace ... 55 ... with 61)

516 386		<b>Appliance unit</b> 1 lifting door with front 51.6 cm 1 panel 1 appliance aperture 58.0 - 59.5 cm 1 pull-out 38.6 cm  <b>Appliance unit with compensation door above appliance aperture</b>	58,0-59,5	GO	60 15 55 36 X5	R/L ▲	667	687	704	844	899	933	1029	1132	-
516 126 256		<b>Appliance unit</b> 1 lifting door with front 51.6 cm 1 panel 1 appliance aperture 58.0 - 59.5 cm 1 drawer 12.6 cm 1 pull-out 25.6 cm  <b>Appliance unit with compensation door above appliance aperture</b>	58,0-59,5	GO	60 15 55 36 X6	R/L ▲	752	772	789	929	983	1019	1114	1225	-
				GO	60 15 55 36 X6A	R/L ▲	752	772	789	929	983	1019	1114	1225	-



# Appliance unit 156 cm high for refrigerator/freezer

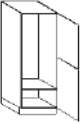



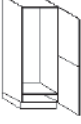



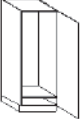




Carcase depth 55.5 cm (standard)

			Price groups											
			Order no.	Hinge side:	Carcase depth	1	2	3	4	5	6	7	8	9
			W H D											
1036		<b>Appliance unit</b> 1 panel 1 appliance aperture 36.2 - 50 cm 1 integrated appliance aperture 88 cm 1 door 103.6 cm	36.2-50,0 88,0	<b>GOI 60 15 55 11X</b>	R/L ▲	407	421	481	570	608	639	702	772	-
		 <b>Appliance unit with integrated ventilation</b>		<b>GOIB 60 15 55 11 X</b>	R/L ▲	422	438	496	586	624	654	719	791	-
1063		<b>Appliance unit</b> 1 panel 1 appliance aperture 36.0 - 45 cm 1 integrated appliance aperture 102.5 cm 1 door 106.3 cm	36.0-45,0 102,5	<b>GOI 60 15 55 12 X4</b>	R/L ▲	407	421	481	570	608	639	702	772	-
		 <b>Appliance unit with integrated ventilation</b>												
906		<b>Appliance unit</b> 1 panel 1 appliance aperture 58.0 - 59.5 cm 1 integrated appliance aperture 88 cm 1 door 90.6 cm	58.0-59,5 88,0	<b>GOI 60 15 55 21 X</b>	R/L ▲	363	375	417	481	524	563	621	683	-
1036		<b>Appliance unit</b> 1 panel 1 appliance aperture 37.3 - 45 cm 1 integrated appliance aperture 102.3 cm 1 door 103.6 cm	37.3-45,0 102,3	<b>GOI 60 15 55 12 X1</b>	R/L ▲	478	493	553	641	679	708	772	849	-
906 646		<b>Appliance unit</b> 1 integrated appliance aperture 88 cm 1 door 90.6 cm 1 door 64.6 cm 2 adjustable shelves	88,0	<b>GI 60 15 55 30 X</b>	R/L ▲	417	435	492	587	625	658	721	793	-
906 256 386		<b>Appliance unit</b> 1 integrated appliance aperture 88 cm 1 door 90.6 cm 1 pull-out 25.6 cm 1 pull-out 38.6 cm  <b>Appliance unit with integrated ventilation</b>	88,0	<b>GI 60 15 55 30 X2</b>	R/L ▲	749	769	825	915	951	982	1046	1151	-
1166 386		<b>Appliance unit</b> 1 integrated appliance aperture 103 cm 1 door 116.6 cm 1 door 38.6 cm  <b>Appliance unit with integrated ventilation</b>	103,0	<b>GI 60 15 55 40 X</b>	R/L ▲	417	435	492	587	625	658	721	793	-
1166 386		<b>Appliance unit</b> 1 integrated appliance aperture 103 cm 1 door 116.6 cm 1 pull-out 38.6 cm  <b>Appliance unit with integrated ventilation</b>	103,0	<b>GI 60 15 55 40 X1</b>	R/L ▲	566	583	641	735	773	805	866	953	-
1296 256		<b>Appliance unit</b> 1 integrated appliance aperture 122.5 cm 1 door 129.6 cm 1 pull-out 25.6 cm  <b>Appliance unit with integrated ventilation</b>	122,5	<b>GI 60 15 55 50 X</b>	R/L ▲	506	531	604	802	862	909	996	1096	-
776 776		<b>Appliance unit with integrated ventilation</b> 1 integrated appliance aperture 122.5 cm 2 doors 77.6 cm	122,5  78	<b>GIB 60 15 55 55 X1</b>	R/L ▲	434	449	508	605	643	676	737	811	-
386 906 256		<b>Appliance unit</b> 1 integrated appliance aperture 122.5 cm 1 door 38.6 cm 1 door 90.6 cm 1 pull-out 25.6 cm	122,5	<b>GI 60 15 55 55 05</b>	R/L ▲	506	531	604	802	862	909	996	1096	-



# Appliance unit 156 cm high for refrigerator/freezer

Carcase depth 55.5 cm (standard)

▲ = Types also available with 61 cm carcass depth (order no. ... replace ... 55 ... with 61)


		Order no.		Hinge side:		Price groups									
		W H D		Carcass depth		1	2	3	4	5	6	7	8	9	
711 841		<b>Appliance unit with integrated ventilation</b> 1 integrated appliance aperture 122.5 cm 1 door 71.1 cm attached to 1 door 84.1 cm	122,5	<b>GIB 60 15 55 55 X8</b>	R/L	▲	434	449	508	605	643	676	737	811	-
				84,5	Not available for: MIAMI, VIVA Important: Observe the appliance manufacturers' permitted front weights for fixed door assembly. See overview of models for front weights.										
776 776		<b>Appliance unit</b> 1 integrated aperture 140 cm 2 doors 77.6 cm	140,0	<b>GI 60 15 55 62 X1</b>	R/L	▲	417	435	492	587	625	658	721	793	-
				78	Important: Observe the appliance manufacturers' permitted front weights for fixed door assembly. See overview of models for front weights.										
711 841		<b>Appliance unit</b> 1 integrated aperture 140 cm 1 door 71.1 cm attached to 1 door 84.1 cm	140,0	<b>GI 60 15 55 62 X8</b>	R/L	▲	417	435	492	587	625	658	721	793	-
				84,5	Not available for: MIAMI, VIVA Important: Observe the appliance manufacturers' permitted front weights for fixed door assembly. See overview of models for front weights.										
1556		<b>Appliance unit</b> 1 integrated aperture 140 cm 1 door 155.6 cm	140,0	<b>GI 60 15 55 62 X4</b>	R/L	▲	496	516	573	668	707	740	802	882	-
					Not available for: CASTELLO, FRAME, MUNICH, NEVADA, VINO, VIVA Important: Observe the appliance manufacturers' permitted front weights for fixed door assembly. See overview of models for front weights.										
1556		<b>Appliance unit with integrated ventilation</b> 1 integrated aperture 140 cm 1 door 155.6 cm	140,0	<b>GIB 60 15 55 62 X4</b>	R/L	▲	513	533	589	686	723	759	819	901	-
					Not available for: CASTELLO, FRAME, MUNICH, NEVADA, VINO, VIVA Important: Observe the appliance manufacturers' permitted front weights for fixed door assembly. See overview of models for front weights.										
906 646		<b>Appliance unit</b> 1 integrated appliance aperture 144.6 cm 1 door 90.6 cm 1 door 64.6 cm	144,6	<b>GI 60 15 55 68 01</b>	R/L	▲	417	435	492	587	625	658	721	793	-
					Important: Observe the appliance manufacturers' permitted front weights for fixed door assembly. See overview of models for front weights.										
386 1166		<b>Appliance unit</b> 1 integrated appliance aperture 144.6 cm 1 door 38.6 cm 1 door 116.6 cm	144,6	<b>GI 60 15 55 68 03</b>	R/L	▲	417	435	492	587	625	658	721	793	-
					Important: Observe the appliance manufacturers' permitted front weights for fixed door assembly. See overview of models for front weights.										
		<b>GIB 60 15 55 68 03</b>	R/L	▲	434	449	507	605	643	676	736	810	-		

## spacefitter frame 156 cm high

906 646		<b>Tall unit spacefitter frame</b> 1 door 90.6 cm connected to 1 door 64.6 cm Carcass depth 10 cm For recess cladding		<b>GPR 30 15 10 02</b>	R/L		230	239	275	359	370	391	435	479	-
				<b>GPR 40 15 10 02</b>	R/L		230	239	275	359	370	391	435	479	-
				<b>GPR 45 15 10 02</b>	R/L		230	239	275	359	370	391	435	479	-
				<b>GPR 50 15 10 02</b>	R/L		230	239	275	384	400	422	465	512	-
				<b>GPR 60 15 10 02</b>	R/L		258	268	308	448	477	498	549	604	-
776 776		<b>Tall unit spacefitter frame</b> 2 doors 77.6 cm Carcass depth 10 cm For recess cladding	78	<b>GPR 30 15 10 01</b>	R/L		230	239	275	359	370	391	435	479	-
				<b>GPR 40 15 10 01</b>	R/L		230	239	275	359	370	391	435	479	-
				<b>GPR 45 15 10 01</b>	R/L		230	239	275	359	370	391	435	479	-
				<b>GPR 50 15 10 01</b>	R/L		230	239	275	384	400	422	465	512	-
				<b>GPR 60 15 10 01</b>	R/L		258	268	308	448	477	498	549	604	-

## Front filler 156 cm high

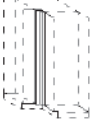



Carcass depth 55.5 cm (standard)

	<b>Tall unit front filler</b> one-part, 156 cm high 3.5 - 10 cm 10.1 - 20 cm	Note: Models with horizontal veneer graining can only be supplied with 2-part front trim panel																			
		<b>GP 10 15</b>											85	85	93	144	144	144	157	173	-
		<b>GP 20 15</b>												93	93	107	170	170	170	182	200



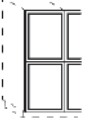



# Front filler 156 cm high

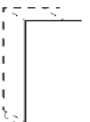

Carcase depth 55.5 cm (standard)

				Price groups										
		Order no. W H D		Hinge side:	Carcase depth	1	2	3	4	5	6	7	8	9
	<b>Tall unit corner filler 90°</b> 156 cm high As corner connection between 2 tall units Without shelf, 9.5 x 9.5 cm	<b>GPW 90 15</b>				124	124	137	200	200	200	214	235	-
		 <b>Note:</b> Models with horizontal veneer graining can only be supplied with 2-part front trim panel												
	<b>Tall unit corner filler 135°</b> 156 cm high For cladding blind corners Planning dimensions 25.9 x 25.9 cm	<b>GPW 135 15</b>				124	124	137	200	200	200	214	235	-
		 <b>Note:</b> Models with horizontal veneer graining can only be supplied with 2-part front trim panel												

## Back cladding 156 cm high with screw-fitted fronts



	<b>Back cladding</b> For tall units, 156 cm high Carcase material with screw-fitted fronts, 90.6 cm and 64.6 cm Only available in grid sizes	per 10 cm Width												
		<b>GVF 15 02</b>				65	69	71	89	91	95	101	111	-
 <b>Important!</b> Plinth panel is supplied loose.														
	<b>Back cladding</b> For tall units, 156 cm high Carcase material with screw-fitted fronts 1 front 77.6 cm attached to 1 front 77.6 cm Only available in grid sizes	per 10 cm Width												
		<b>GVF 15 01</b>				65	69	71	89	91	95	101	111	-
 <b>Important!</b> Plinth panel is supplied loose.														

## Back cladding 156 cm high

		Order no. W H D		Hinge side:	Carcase depth	Decor groups								
						M10	M20	M30	M40	M50	M60	M70	M80	M90
	<b>Back cladding</b> For tall units, 156 cm high 16 mm thick	per 10 cm Width												
		<b>GVK 15</b>				27,50	48	56	75	75	75	75	75	-
	<b>Tall unit background filler</b> Width: 20 cm For fitting flush with carcase 156 cm high	<b>GPSL 00 15</b>				45	53	89	119	119	119	119	119	-

<b>M 10</b> K M10 laminate	<b>M 20</b> D M20 Laminate decor	<b>M 30</b> I M30 RESOPAL PRO super matt IH M30 HPL PRO PW M30 PRIMEWOOD/Basic Veneer	<b>M 40</b> A M40 DIRECTLACK matt L M40 DIRECTLACK high-gloss	<b>M 50</b> B M50 Velvet lacquer S M50 microstructure lacquer
<b>M 60</b> QH M60 SMARTGLAS high-gloss QM M60 SMARTGLAS satin-finish	<b>M 70</b> F M70 veneer / oak / walnut Z M70 Veneer / Bavaria	<b>M 80</b> C1 M80 FENIX stainless-steel look H M80 high gloss-Lacquer MP M80 laqué mat Premium	<b>M 90</b>	




# Visible sides / increased side depth 156 cm high

		Decor groups										
		M10 M20 M30 M40 M50 M60 M70 M80 M90										
		Hinge side: Carcase depth										
		Order no. W H D										
 <p><b>Tall unit visible side</b></p> <p>55.5 cm side depth Fixed dimension, not variable</p> <p>57.5 cm side depth Fixed dimension, not variable</p> <p>60.5 cm side depth Fixed dimension, not variable</p> <p>61 cm side depth Fixed dimension, not variable</p>	<p><b>Important!</b> Installation instead of a normal unit side. Only available in the listed side depths. For other dimensions, use GSVT...</p>	<b>GSV 15</b>	R/L	0	0	122	122	162	162	202	257	-
		<b>GSV 15 5</b>	R/L	0	0	122	122	162	162	202	257	-
		<b>GSV 15 6</b>	R/L	0	0	122	122	162	162	202	257	-
		<b>GSV 15 6 1</b>	R/L	0	0	122	122	162	162	202	257	-
 <p><b>Tall unit increased side depth</b></p> <p>from 61.1 cm up to 90 cm side depth</p> <p>Up to 60.9 cm side depth</p>	<p><b>Important!</b> Installation instead of a normal unit side.</p>	<b>GSVT 15</b>	R/L	88	118	265	265	353	353	440	534	-
		<b>GSVT 15 6</b>	R/L	45	58	178	178	236	236	295	374	-
<b>M 10</b>	<b>M 20</b>	<b>M 30</b>	<b>M 40</b>	<b>M 50</b>								
K M10 laminate	D M20 Laminate decor	I M30 RESOPAL PRO super matt IH M30 HPL PRO PW M30 PRIMEWOOD/Basic Veneer	A M40 DIRECTLACK matt L M40 DIRECTLACK high-gloss	B M50 Velvet lacquer P M50 Soft lacquer RH M50 Velvet lacquer wood texture RW M50 Velvet lacquer spackle effect S M50 microstructure lacquer								
<b>M 60</b>	<b>M 70</b>	<b>M 80</b>	<b>M 90</b>									
QH M60 SMARTGLAS high-gloss QM M60 SMARTGLAS satin-finish	F M70 veneer / oak / walnut V M70 Velvet lacquer textured Z M70 Veneer / Bavaria	C1 M80 FENIX stainless-steel look H M80 high gloss-Lacquer MP M80 laqué mat Premium O M80 Veneered										

## Shelf units 156 cm high

Carcase depth 57.7 cm, flush with front



■ = Models also available in 36.1/47.7/63.2 cm carcase depth (Order no.: replace ... 58 ... with 36/48/63)

 <p><b>Tall shelf unit</b></p> <p>1 fixed shelf 2 adjustable shelves</p> <p>wide in cm: 13-30</p> <p>wide in cm: 30,1-40</p> <p>wide in cm: 40,1-45</p> <p>wide in cm: 45,1-50</p> <p>wide in cm: 50,1-60</p>		<b>GR 30 15 58</b>	■	357	-	-	-	1160	-	1160	1160	-	
		<b>GR 40 15 58</b>	■	357	-	-	-	1160	-	1160	1160	-	
		<b>GR 45 15 58</b>	■	357	-	-	-	1160	-	1160	1160	-	
		<b>GR 50 15 58</b>	■	357	-	-	-	1160	-	1160	1160	-	
		<b>GR 60 15 58</b>	■	357	-	-	-	1160	-	1160	1160	-	
 <p><b>Tall shelf end unit</b></p> <p>25 x 57.7 cm 3 fixed shelves For adjacent fitting left or right</p>		<b>GRA 25 15 58</b>	R/L	■	465	-	-	-	1002	-	1002	1002	-
		<p><b>Important!</b> Only available in 25 cm width</p>											
 <p><b>Tall shelf end unit</b></p> <p>34 x 57.7 cm 3 fixed shelves For adjacent fitting left or right</p>		<b>GRA 34 15 58</b>	R/L	■	465	-	-	-	1142	-	1142	1142	-
<b>M 10</b>	<b>M 20</b>	<b>M 30</b>	<b>M 40</b>	<b>M 50</b>									
K M10 laminate				B M50 Velvet lacquer S M50 microstructure lacquer									
<b>M 60</b>	<b>M 70</b>	<b>M 80</b>	<b>M 90</b>										
	F M70 veneer / oak / walnut Z M70 Veneer / Bavaria	H M80 high gloss-Lacquer MP M80 laqué mat Premium											

## Dishwasher surround 156 cm high

Carcase depth 55.5 cm (standard)

▲ = Types also available with 61 cm carcase depth (order no. ... replace ... 55 ... with 61)

		Price groups										
		1 2 3 4 5 6 7 8 9										
		Hinge side: Carcase depth										
		Order no. W H D										
 <p><b>Base for raised dishwasher (86 cm high)</b></p> <p>with top shelf, 57.5 cm high</p> <p>1 pull-out 38.6 cm, 45.5 cm deep, angled at top</p> <p>1 pull-out 38.6 cm, 45.5 cm deep</p> <p>1 collection tray (available only in 60 cm width)</p> <p>Overall height 156 cm</p> <p>Planning dimension 65 cm</p>	 <p><b>Not available for:</b> ALU TEC RP</p> <p><b>Important!</b> Plan free-standing with 25 mm panels, planning dimension 65 cm</p>	<b>UGS 45 15 55 87</b>	▲	436	444	492	546	546	568	620	682	-
		<b>UGS 60 15 55 87</b>	▲	467	480	524	596	596	623	681	749	-



# Raised dishwashers

For carcass height 156 cm, carcass depth 55.5 cm

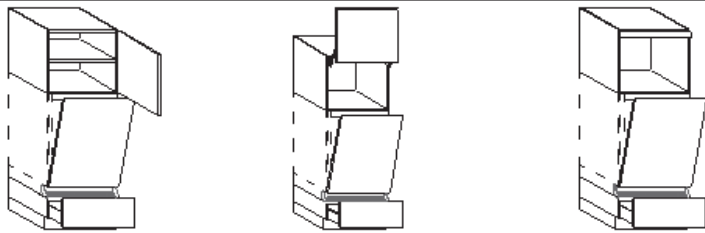
Pull-out panel at bottom 25.6 cm high

**Note:**

Do not plan at the end of a row. Only plan between tall units.

Always follow the assembly instructions from the appliance manufacturers.

▲ = Types also available with 61 cm carcass depth (order no. ... replace ... 55 ... with 61)



			Price groups										
Order no.			Hinge side:	Carcass depth	1	2	3	4	5	6	7	8	9
W	H	D											
535		<b>Dresser unit above raised dishwasher</b> Height 53.5 cm 1 door 51.6 cm 1 adjustable shelf 1 vapour protector		▲	226	236	258	314	339	354	390	429	-
535		<b>Dresser unit with lifting door for microwave above raised dishwasher</b> Height 53.5 cm 1 lifting door with front 51.6 cm 1 vapour protector		▲	384	391	410	467	483	495	562	618	-
		<b>Dresser unit for microwave above raised dishwasher</b> Height 53.5 cm 1 panel 1 appliance aperture 35 - 37.2 cm 1 vapour protector	35,0-37,2	▲	226	236	258	314	339	354	390	429	-
776		<b>Base unit door, 77.6 cm</b> 59.6 cm wide As front panel for fully integrated dishwashers 86 cm high and pull-out fridges and freezers 59.6 cm wide with 60 cm											
		<b>Spacer strips for fully integrated dishwasher</b> Appliance height 82 cm 2 spacer strips Colour: Art Pepper 6 cm high			122	126	138	146	232	253	294	323	-
256		<b>Base for raised dishwasher (86 cm high)</b> with top shelf, 15.5 cm high 1 drawer with pull-out panel 25.6 cm, 45.5 cm deep angled at top 1 collection tray (available only in 60 cm width)		▲	276	290	320	378	412	439	480	528	-
					Not available for: ALU TEC RP								
					Important! Plan free-standing with 25 mm panels								
256		<b>Base for raised dishwasher (86 cm high)</b> only for dishwashers with <b>VARIO HINGE</b> with top shelf, 15.5 cm high 1 drawer with pull-out panel 25.6 cm not angled 45.5 cm deep 1 collection tray (available only in 60 cm width)		▲	276	290	320	378	412	439	480	528	-
					Important! Plan free-standing with 25 mm panels								

# Raised dishwashers

For carcass height 156 cm, carcass depth 55.5 cm

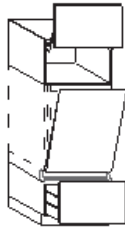
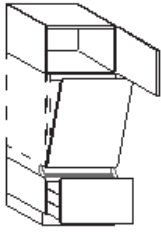
Pull-out panel at bottom 38.6 cm high



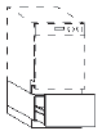

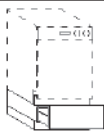

**Note:**

Do not plan at the end of a row. Only plan between tall units.

Always follow the assembly instructions from the appliance manufacturers.

▲ = Types also available with 61 cm carcass depth (order no. ... replace ... 55 ... with 61)



Order no. W H D		Hinge side: R/L	Carcass depth	Price groups											
				1	2	3	4	5	6	7	8	9			
386	 <p><b>Dresser unit above raised dishwasher</b> Height 40.5 cm 1 door 38.6 cm 1 vapour protector</p>	A	60 40 55	R/L ▲	177	184	200	242	261	275	298	328	-		
386	 <p><b>Dresser unit with lifting door for microwave above raised dishwasher</b> Height 40.5 cm 1 lifting door with front 38.6 cm 1 vapour protector</p>	ALT	60 40 55	▲	328	333	348	391	395	399	460	506	-		
776	 <p><b>Base unit door, 77.6 cm</b> 59.6 cm wide As front panel for fully integrated dishwashers 86 cm high and pull-out fridges and freezers 59.6 cm wide with 60 cm</p>	 <i>Always order article DL 60 6 if a high-volume dishwasher has not been included in planning!</i>		UT	60 78 1		122	126	138	146	232	253	294	323	-
	 <p><b>Spacer strips for fully integrated dishwasher</b> Appliance height 82 cm 2 spacer strips Colour: Art Pepper 6 cm high</p>	DL	60 6			32									
386	 <p><b>Base for raised dishwasher (86 cm high)</b> with top shelf, 28.5 cm high 1 pull-out 38.6 cm, 45.5 cm deep angled at top 1 collection tray (available only in 60 cm width)</p>		UGS 60 11 55 87	▲	285	298	326	389	419	445	485	534	-		
		 <b>Not available for:</b> ALU TEC RP													
		 <b>Important!</b> Plan free-standing with 25 mm panels													
386	 <p><b>Base for raised dishwasher (86 cm high)</b> only for dishwashers with <b>VARIO HINGE</b> with top shelf, 28.5 cm high 1 pull-out panel 38.6 cm, 45.5 cm deep not angled 1 collection tray (available only in 60 cm width)</p>		UGV 60 11 55 87	▲	285	298	326	389	419	445	485	534	-		
		 <b>Important!</b> Plan free-standing with 25 mm panels													

# Raised dishwashers

For carcass height 156 cm, carcass depth 55.5 cm

Pull-out panel at bottom 32.1 cm high

**Note:**

Do not plan at the end of a row. Only plan between tall units.

Always follow the assembly instructions from the appliance manufacturers.

▲ = Types also available with 61 cm carcass depth (order no. ... replace ... 55 ... with 61)



				Price groups														
Order no.				Hinge side:	Carcass depth	1	2	3	4	5	6	7	8	9				
W	H	D																
470		<b>Dresser unit for microwave above raised dishwasher</b> Height 47 cm 1 panel 1 appliance aperture 35 - 36.5 cm 1 vapour protector		AN	60	47	55	▲	177	184	200	242	261	275	298	328	-	
776		<b>Base unit door, 77.6 cm</b> 59.6 cm wide As front panel for fully integrated dishwashers 86 cm high and pull-out fridges and freezers 59.6 cm wide with 60 cm		Always order article DL 60 6 if a high-volume dishwasher has not been included in planning!														
		<b>Spacer strips for fully integrated dishwasher</b> Appliance height 82 cm 2 spacer strips Colour: Art Pepper 6 cm high		DL	60	6			32									
321		<b>Base for raised dishwasher</b> with top shelf, 22.0 cm high 1 drawer with pull-out panel 32.1 cm, 45.5 cm deep, angled at top 1 collection tray (available only in 60 cm width)		UGS	60	15	55	871	▲	276	290	320	378	412	439	480	528	-
		<b>Base for raised dishwasher</b> only for dishwashers with <b>VARIO HINGE</b> with top shelf, 22.0 cm high 1 drawer with pull-out panel 32.1 cm, 45.5 cm deep, not chamfered 1 collection tray (available only in 60 cm width)		UGV	60	15	55	871	▲	276	290	320	378	412	439	480	528	-
				Important! Plan free-standing with 25 mm panels														
		<b>Vapour protector for raised dishwashers</b> Finish: metal to protect the fronts above		WSB-45														
				WSB-60														

# 6.3

Height  
168.8 cm

## Tall units 168.8 cm

Tall units 168.8 cm high	XL 6.3.3-XL 6.3.6
Tall units 168.8 cm high with glass fronts	XL 6.3.6
Additional equipment	XL 6.3.6
Tall units 168.8 cm high with roller shutter	XL 6.3.7
Appliance unit 168.8 cm high for microwave / oven	XL 6.3.8
Appliance unit 168.8 cm high for microwave / oven Double aperture	XL 6.3.8-XL 6.3.9
Appliance unit 168.8 cm high for microwave / oven Lifting door / aperture	XL 6.3.9
Appliance unit 168.8 cm high for refrigerator/freezer spacefitter frame 168.8 cm high	XL 6.3.9-XL 6.3.10
Front filler 168.8 cm high	XL 6.3.10
Back cladding 168.8 cm high with screw-fitted fronts	XL 6.3.11
Back cladding 168.8 cm high	XL 6.3.12
Visible sides / increased side depth 168.8 cm high	XL 6.3.12
Shelf units 168.8 cm high	XL 6.3.12
Raised dishwashers For carcase height 168.8 cm, carcase depth 55.5 cm	XL 6.3.13
Raised dishwashers For carcase height 168.8 cm, carcase depth 55.5 cm	XL 6.3.14
Raised dishwashers For carcase height 168.8 cm, carcase depth 55.5 cm	XL 6.3.15
Raised dishwashers For carcase height 168.8 cm, carcase depth 55.5 cm	XL 6.3.16

### Legend:



Available with grip ledge N...



Not available with grip ledge N...



This symbol indicates which models are available



This symbol indicates which models are not available



wall-mounted units



available depths for wall-mounted units



Planning advice



This symbol illustrates which appliance units are delivered with integrated ventilation



Not available with „push-to-open“ fitting



Aperture height specifications



Available carcase depths 34/45.5/55.5/61.0 cm



Available carcase depths 45.5/55.5/61.0 cm

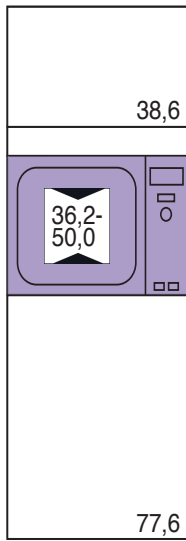


Available carcase depths 55.5/61.0 cm



## Planning advice for appliance shelves with compensation panels or compensation door

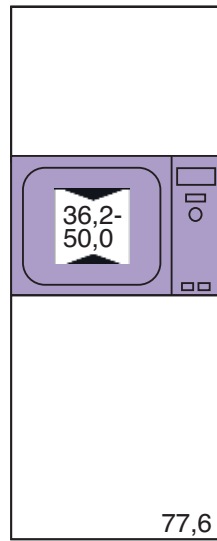
Height  
168,8 cm



GO601655101

Door

Compensation  
panel



GO6016101A

Compensation lifting door  
38.6 cm + compensation panel

By changing the order number, the compensation panels above the appliance apertures can be replaced by a special-size door or lifting door.







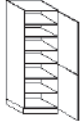
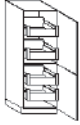
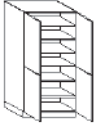

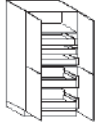

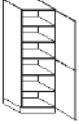
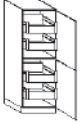
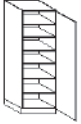
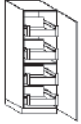
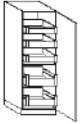
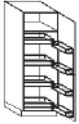

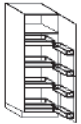
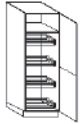
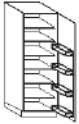
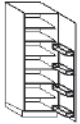
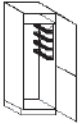
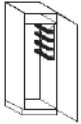
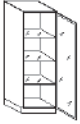


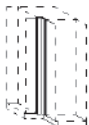





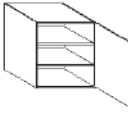
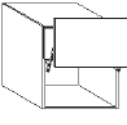
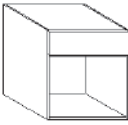
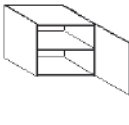
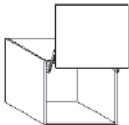
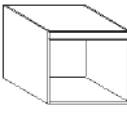
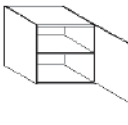
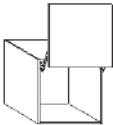
Advantages:

- Full use can be made of the storage space above the appliance aperture
- Reduction of horizontal joints

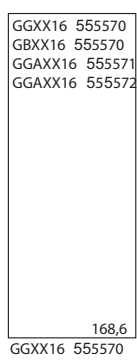
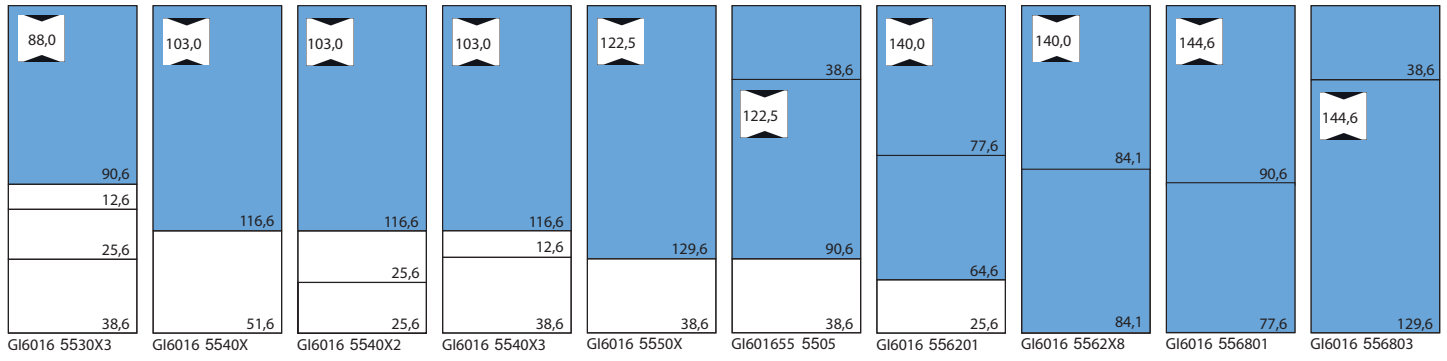
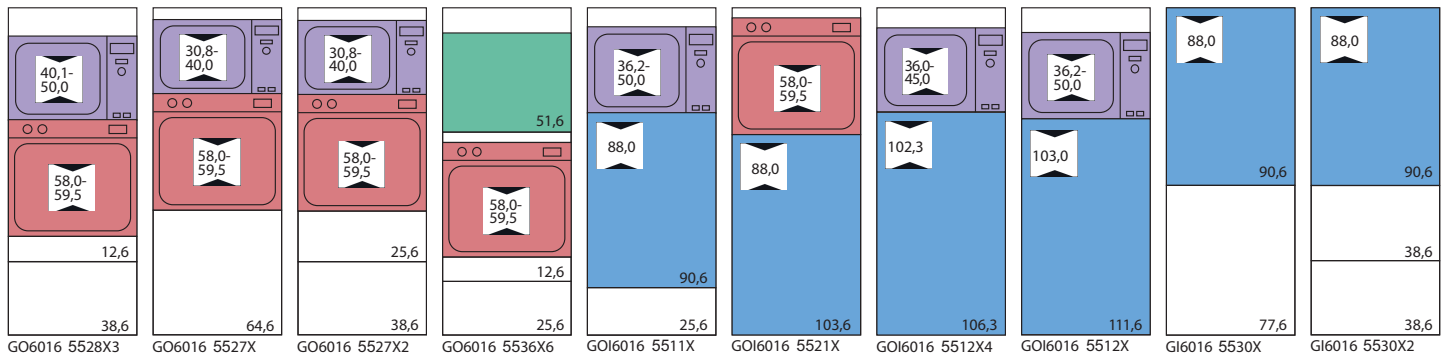
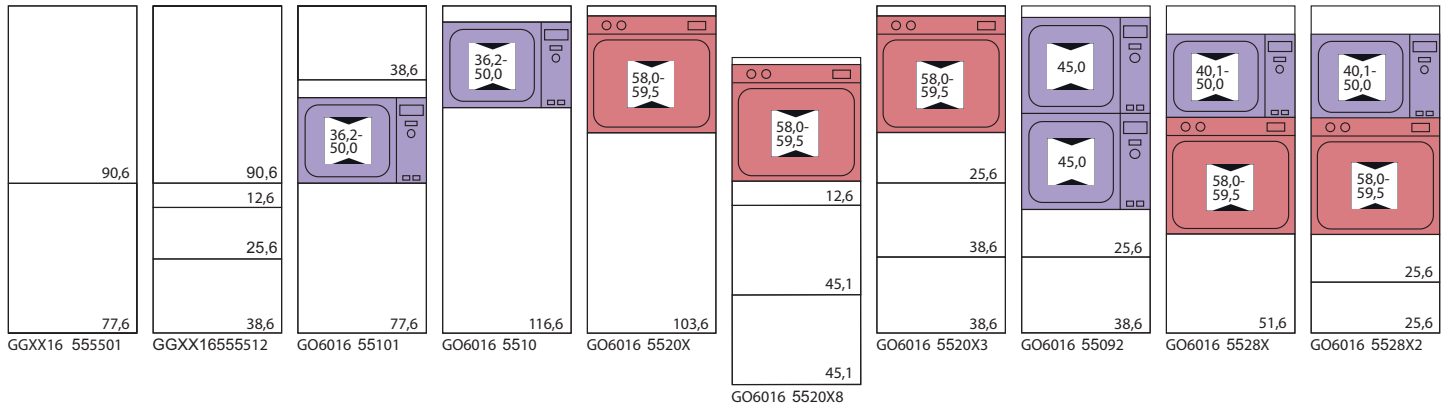


Not available for models:  
**MIAMI, VIVA**

# The most important tall unit types 168.8 cm high

Page XL 6.3.3	Page XL 6.3.3	Page XL 6.3.3	Page XL 6.3.3	Page XL 6.3.3	Page XL 6.3.3	Page XL 6.3.3	Page XL 6.3.3	Page XL 6.3.3
								
<b>GGGS..165501</b> Unit widths: 25	<b>GVSTP..165501</b> Unit widths: 25	<b>GV..165501</b> Unit widths: 30/45	<b>GV..165570</b> Unit widths: 30/45	<b>GVP..165501</b> Unit widths: 30/45	<b>GVP..165570</b> Unit widths: 30/45	<b>GG..165501</b> Unit widths: 30/40/45/50/60	<b>GGA..165501</b> Unit widths: 30/40/45/50/60	<b>GG..165501</b> Unit widths: 80/90
Page XL 6.3.3	Page XL 6.3.4	Page XL 6.3.4	Page XL 6.3.4	Page XL 6.3.4	Page XL 6.3.4	Page XL 6.3.4	Page XL 6.3.4	Page XL 6.3.5
								
<b>GGA..165502</b> Unit widths: 30/40/45/50/60	<b>GGA..165503</b> Unit widths: 90	<b>GG..165512</b> Unit widths: 30/40/45/50/60	<b>GG..165505</b> Unit widths: 30/40/45/50/60	<b>GGA..165506</b> Unit widths: 30/40/45/50/60	<b>GG..165570</b> Unit widths: 30/40/45/50/60	<b>GGA..165571</b> Unit widths: 30/40/45/50/60	<b>GGA..165572</b> Unit widths: 30/40/45/50/60	<b>GVP..165501</b> Unit widths: 50/60
Page XL 6.3.5	Page XL 6.3.5	Page XL 6.3.5	Page XL 6.3.5	Page XL 6.3.5	Page XL 6.3.5	Page XL 6.3.5	Page XL 6.3.6	Page XL 6.3.7
								
<b>GVP..0165501</b> Unit widths: 100	<b>GV..165501</b> Unit widths: 50/60	<b>GVPS..1655</b> Unit widths: 60	<b>GVT..165501</b> Unit widths: 50/60	<b>GVPT..165501</b> Unit widths: 50/60	<b>GB..165501</b> Unit widths: 30/40/45/50/60	<b>GB..165570</b> Unit widths: 30/40/45/50/60	<b>GGGD..165570</b> Unit widths: 45/50/60	<b>TAB-AZ..55</b> Unit widths: 45/50/60/80/90
Page XL 6.3.11	Page XL 6.3.11	Page XL 6.3.11	Page XL 6.3.12	Page XL 6.3.13	Page XL 6.3.13	Page XL 6.3.13	Page XL 6.3.14	Page XL 6.3.14
								
<b>GP.16</b> Unit widths: 3,5-20	<b>GPW..16</b> Unit widths: 9,5x9,5	<b>GPW..16</b> Unit widths: 25,9x25,9	<b>GVF..02</b> Unit widths: 10-250	<b>GR..1658</b> Unit widths: 30/40/45/50/60	<b>GRA..1658</b> Unit widths: 25/34	<b>GRA..1658</b> Unit widths: 25/34	<b>A..6655</b> Unit widths: 60	<b>ALT..6655</b> Unit widths: 60
Page XL 6.3.14	Page XL 6.3.15	Page XL 6.3.15	Page XL 6.3.15	Page XL 6.3.16	Page XL 6.3.16			
								
<b>AN..66552</b> Unit widths: 60	<b>A..5355</b> Unit widths: 60	<b>ALT..5355</b> Unit widths: 60	<b>AN..53552</b> Unit widths: 60	<b>A..6055</b> Unit widths: 60	<b>ALT..6055</b> Unit widths: 60			

# Recess overview Tall units 168.8 cm


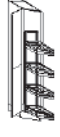

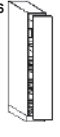


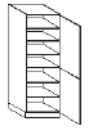
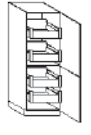

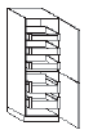


# Tall units 168.8 cm high

Carcase depth 55.5 cm (standard)

- = Models also available in 34/45.5/61 cm carcass depth (Order no.: ... replace ... 55 ... with 34/45/61)
- = Models also available in 45.5/61 cm carcass depth (order no.: replace ... 55 ... with 45/61)
- ▲ = Types also available with 61 cm carcass depth (order no.: ... replace ... 55 ... with 61)

Order no.  
W H D

	Hinge side:	Carcass depth	Price groups																
			1	2	3	4	5	6	7	8	9								
906 776  III. left <b>Crockery cupboard angled 37.2°</b> 1 door 90.6 cm 1 fixed shelf 1 door 77.6 cm 5 adjustable shelves For adjacent fitting left or right	R/L	■	78	GGG	25	16	55	01	508	527	573	653	705	735	794	873	-		
906 776  III. left <b>Larder unit angled 37.2°</b> 1 door 90.6 cm connected to 1 door 77.6 cm 1 pull-out element 4 adjustable wooden shelves with chrome-plated square rail For adjacent fitting left or right	R/L	▲	78	GVSTP25	16	55	01	1233	1254	1302	1364	1417	1445	1504	1654	-			
906 776  <b>Larder unit</b> 1 pull-out 1 door 90.6 cm connected to 1 door 77.6 cm on telescopic rails Full height can be pulled out With 5 adjustable wire baskets (chrome-plated)			78	GV	30	16	55	01	▲	861	887	908	1037	1087	1133	1219	1341	-	
												▲	886	915	962	1090	1145	1202	1299
1686  <b>Larder unit</b> 1 pull-out 168.6 cm on telescopic rails Full height can be pulled out With 5 adjustable wire baskets (chrome-plated)	N	▲	78	GV	30	16	55	70	▲	943	969	989	1117	1168	1214	1299	1429	-	
												▲	968	995	1042	1172	1226	1283	1382
			Width 30, 45 Not available for: ALUELEMENTS, ATLANTA-B, ATLANTA-S, BERGEN, CASTELLO, CHALET-B, CHALET-S, CHICAGO, FRAME, LUGANO, LUX-B, MIAMI, MODENA, MUNICH, NEVADA, NOBEL-B, NOBEL-S, ORLANDO-B, ORLANDO-S, OSLO 15, PADUA, SOFIE-B, SOFIE-S, TESSIN 15, TIM 15, VINO, VIVA, YORK-B, YORK-S																
906 776  <b>Larder unit</b> 1 pull-out 1 door 90.6 cm connected to 1 door 77.6 cm on telescopic rails Full height can be pulled out with 5 adjustable wooden shelves with chrome-plated square rail			78	GVP	30	16	55	01	▲	1028	1056	1074	1200	1251	1294	1383	1521	-	
												▲	1054	1102	1129	1256	1312	1366	1462
1686  <b>Larder unit</b> 1 pull-out 168.6 cm on telescopic rails Full height can be pulled out with 5 adjustable wooden shelves with chrome-plated square rail	N	▲	78	GVP	30	16	55	70	▲	1110	1136	1154	1280	1332	1378	1463	1609	-	
												▲	1134	1184	1208	1338	1393	1449	1548
			Width 30, 45 Not available for: ALUELEMENTS, ATLANTA-B, ATLANTA-S, BERGEN, CASTELLO, CHALET-B, CHALET-S, CHICAGO, FRAME, LUGANO, LUX-B, MIAMI, MODENA, MUNICH, NEVADA, NOBEL-B, NOBEL-S, ORLANDO-B, ORLANDO-S, OSLO 15, PADUA, SOFIE-B, SOFIE-S, TESSIN 15, TIM 15, VINO, VIVA, YORK-B, YORK-S																
906 776  <b>Crockery cupboard</b> 1 door 90.6 cm 1 door 77.6 cm 1 fixed shelf 5 adjustable shelves	R/L	■	78	GG	30	16	55	01	R/L	■	328	341	392	477	528	557	618	680	-
				GG	40	16	55	01	R/L	■	328	341	392	477	528	557	618	680	-
				GG	45	16	55	01	R/L	■	328	341	392	477	528	557	618	680	-
				GG	50	16	55	01	R/L	■	328	341	392	526	569	601	660	726	-
				GG	60	16	55	01	R/L	■	367	381	440	621	677	710	782	860	-
906 776  <b>Larder unit</b> 1 door 90.6 cm with wide angle hinges 2 internal pull-outs 1 fixed shelf 1 door 77.6 cm with wide angle hinges 2 internal pull-outs  Planning advice: Take account of opening angle	R/L	■	78	GGA	30	16	55	01	R/L	■	969	981	1031	1100	1151	1182	1243	1367	-
				GGA	40	16	55	01	R/L	■	997	1012	1063	1130	1182	1212	1273	1400	-
				GGA	45	16	55	01	R/L	■	1010	1021	1072	1138	1190	1221	1282	1410	-
				GGA	50	16	55	01	R/L	■	1024	1036	1087	1153	1206	1235	1296	1426	-
				GGA	60	16	55	01	R/L	■	1044	1057	1108	1174	1225	1255	1317	1449	-
			Planning advice: Doors with wide angle hinges may not be planned alongside units or panels if the protrusion to the front of the adjoining article is greater than 3 cm (hinge side). Doors with wide angle hinges protrude over the carcass side.																
906 776  <b>Crockery cupboard</b> 2 doors 90.6 cm 2 doors 77.6 cm 1 fixed shelf 5 adjustable shelves			78	GG	80	16	55	01	■	710	737	841	997	1064	1115	1229	1352	-	
												■	710	737	841	997	1064	1115	1229
906 776  <b>Larder unit</b> 1 door 90.6 cm with wide angle hinges 3 internal drawers 1 fixed shelf 1 door 77.6 cm with wide angle hinges 2 internal pull-outs  Planning advice: Take account of opening angle	R/L	■	78	GGA	30	16	55	02	R/L	■	976	989	1039	1109	1160	1189	1252	1377	-
				GGA	40	16	55	02	R/L	■	1009	1020	1071	1137	1189	1220	1280	1408	-
				GGA	45	16	55	02	R/L	■	1017	1028	1079	1147	1198	1227	1290	1419	-
				GGA	50	16	55	02	R/L	■	1031	1044	1094	1161	1214	1243	1305	1436	-
				GGA	60	16	55	02	R/L	■	1054	1066	1116	1183	1233	1264	1325	1458	-
			Planning advice: Doors with wide angle hinges may not be planned alongside units or panels if the protrusion to the front of the adjoining article is greater than 3 cm (hinge side). Doors with wide angle hinges protrude over the carcass side.																

# Tall units 168.8 cm high

Carcase depth 55.5 cm (standard)

■ = Models also available in 34/45.5/61 cm carcise depth (Order no.: ... replace ... 55 ... with 34/45/61)  
 □ = Models also available in 45.5/61 cm carcise depth (order no.: replace ... 55 ... with 45/61)  
 ▲ = Types also available with 61 cm carcise depth (order no. ... replace ... 55 ... with 61)

Order no.  
W H D

Hinge side:	Carcise depth	Price groups									
		1	2	3	4	5	6	7	8	9	
■	78	<b>GGA 90 16 55 03</b>	1595	1619	1717	1866	1969	2028	2153	2368	-
		Planning advice: Doors with wide angle hinges may not be planned alongside units or panels if the protrusion to the front of the adjoining article is greater than 3 cm (hinge side). Doors with wide angle hinges protrude over the carcise side.									
R/L ■	78	<b>GG 30 16 55 12</b>	803	816	866	951	1004	1032	1094	1203	-
		<b>GG 40 16 55 12</b>	803	816	866	951	1004	1032	1094	1203	-
		<b>GG 45 16 55 12</b>	803	816	866	951	1004	1032	1094	1203	-
		<b>GG 50 16 55 12</b>	803	816	866	1002	1044	1075	1136	1250	-
		<b>GG 60 16 55 12</b>	843	858	916	1096	1151	1186	1257	1383	-
R/L ■	84,5	<b>GG 30 16 55 05</b>	328	341	392	477	528	557	618	680	-
		<b>GG 40 16 55 05</b>	328	341	392	477	528	557	618	680	-
		<b>GG 45 16 55 05</b>	328	341	392	477	528	557	618	680	-
		<b>GG 50 16 55 05</b>	328	341	392	526	569	601	660	726	-
		<b>GG 60 16 55 05</b>	367	381	440	621	677	710	782	860	-
Width 30, 40, 45, 50, 60 Not available for: MIAMI, VIVA											
R/L ■	84,5	<b>GGA 30 16 55 06</b>	969	981	1031	1100	1151	1182	1243	1367	-
		<b>GGA 40 16 55 06</b>	997	1012	1063	1130	1182	1212	1273	1400	-
		<b>GGA 45 16 55 06</b>	1010	1021	1072	1138	1190	1221	1282	1410	-
		<b>GGA 50 16 55 06</b>	1024	1036	1087	1153	1206	1235	1296	1426	-
		<b>GGA 60 16 55 06</b>	1044	1057	1108	1174	1225	1255	1317	1449	-
Width 30, 40, 45, 50, 60 Not available for: MIAMI, VIVA Planning advice: Doors with wide angle hinges may not be planned alongside units or panels if the protrusion to the front of the adjoining article is greater than 3 cm (hinge side). Doors with wide angle hinges protrude over the carcise side.											
R/L ■	N.A.	<b>GG 30 16 55 70</b>	410	422	474	557	608	639	700	770	-
		<b>GG 40 16 55 70</b>	410	422	474	557	608	639	700	770	-
		<b>GG 45 16 55 70</b>	410	422	474	557	608	639	700	770	-
		<b>GG 50 16 55 70</b>	410	422	474	606	650	682	742	816	-
		<b>GG 60 16 55 70</b>	446	464	523	702	759	791	862	948	-
Width 30, 40, 45, 50, 60 Not available for: ALUELEMENTS, ATLANTA-B, ATLANTA-S, BERGEN, CASTELLO, CHALET-B, CHALET-S, CHICAGO, FRAME, LUGANO, LUX-B, MIAMI, MODENA, MUNICH, NEVADA, NOBEL-B, NOBEL-S, ORLANDO-B, ORLANDO-S, OSLO 15, PADUA, SOFIE-B, SOFIE-S, TESSIN 15, TIM 15, VINO, VIVA, YORK-B, YORK-S Each front has a tightening fitting Ranges without fitting: SMARTGLAS, NOBEL, SOFIE, YORK, LUGANO, TALEA, RIVA, GARDA, ATLANTA, ORLANDO, CHICAGO without tightening fitting											
R/L ■	N.A.	<b>GGA 30 16 55 71</b>	1049	1063	1112	1182	1232	1262	1324	1456	-
		<b>GGA 40 16 55 71</b>	1079	1092	1143	1211	1262	1292	1353	1488	-
		<b>GGA 45 16 55 71</b>	1090	1102	1152	1220	1272	1302	1363	1499	-
		<b>GGA 50 16 55 71</b>	1106	1116	1168	1276	1322	1352	1413	1554	-
		<b>GGA 60 16 55 71</b>	1154	1172	1227	1393	1449	1482	1554	1709	-
Width 30, 40, 45, 50, 60 Not available for: ALUELEMENTS, ATLANTA-B, ATLANTA-S, BERGEN, CASTELLO, CHALET-B, CHALET-S, CHICAGO, FRAME, LUGANO, LUX-B, MIAMI, MODENA, MUNICH, NEVADA, NOBEL-B, NOBEL-S, ORLANDO-B, ORLANDO-S, OSLO 15, PADUA, SOFIE-B, SOFIE-S, TESSIN 15, TIM 15, VINO, VIVA, YORK-B, YORK-S Each front has a tightening fitting Ranges without fitting: SMARTGLAS, NOBEL, SOFIE, YORK, LUGANO, TALEA, RIVA, GARDA, ATLANTA, ORLANDO, CHICAGO without tightening fitting Planning advice: Doors with wide angle hinges may not be planned alongside units or panels if the protrusion to the front of the adjoining article is greater than 3 cm (hinge side). Doors with wide angle hinges protrude over the carcise side.											
R/L ■	N.A.	<b>GGA 30 16 55 72</b>	1058	1071	1120	1189	1242	1271	1333	1466	-
		<b>GGA 40 16 55 72</b>	1089	1101	1151	1219	1271	1300	1361	1497	-
		<b>GGA 45 16 55 72</b>	1097	1110	1160	1227	1278	1310	1371	1508	-
		<b>GGA 50 16 55 72</b>	1112	1127	1176	1284	1329	1359	1419	1561	-
		<b>GGA 60 16 55 72</b>	1165	1180	1236	1401	1458	1491	1561	1717	-
Width 30, 40, 45, 50, 60 Not available for: ALUELEMENTS, ATLANTA-B, ATLANTA-S, BERGEN, CASTELLO, CHALET-B, CHALET-S, CHICAGO, FRAME, LUGANO, LUX-B, MIAMI, MODENA, MUNICH, NEVADA, NOBEL-B, NOBEL-S, ORLANDO-B, ORLANDO-S, OSLO 15, PADUA, SOFIE-B, SOFIE-S, TESSIN 15, TIM 15, VINO, VIVA, YORK-B, YORK-S Each front has a tightening fitting Ranges without fitting: SMARTGLAS, NOBEL, SOFIE, YORK, LUGANO, TALEA, RIVA, GARDA, ATLANTA, ORLANDO, CHICAGO without tightening fitting Planning advice: Doors with wide angle hinges may not be planned alongside units or panels if the protrusion to the front of the adjoining article is greater than 3 cm (hinge side). Doors with wide angle hinges protrude over the carcise side.											

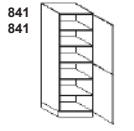


**Crockery cupboard**  
 2 doors 90.6 cm  
 2 doors 77.6 cm  
 with wide angle hinges  
 3 internal drawers  
 1 fixed shelf  
 2 internal pull-outs

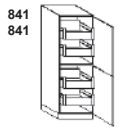
Planning advice:  
 Take account of opening angle



**Crockery cupboard**  
 1 door 90.6 cm  
 3 adjustable shelves  
 1 drawer  
 1 pull-out 25.6 cm  
 1 pull-out 38.6 cm



**Crockery cupboard**  
 1 door 84.1 cm  
 1 door 84.1 cm  
 1 fixed shelf  
 4 adjustable shelves

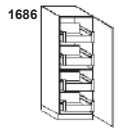


**Larder unit**  
 1 door 84.1 cm with wide angle hinges  
 2 internal pull-outs  
 1 fixed shelf  
 1 door 84.1 cm with wide angle hinges  
 2 internal pull-outs

Planning advice:  
 Take account of opening angle



**Crockery cupboard**  
 1 door 168.6 cm  
 1 fixed shelf  
 5 adjustable shelves



**Larder unit**  
 1 door 168.6 cm with wide angle hinges  
 2 internal pull-outs  
 1 fixed shelf  
 2 internal pull-outs

Planning advice:  
 Take account of opening angle



**Larder unit**  
 1 door 168.6 cm with wide angle hinges  
 3 internal drawers  
 1 fixed shelf  
 2 internal pull-outs





Planning advice:  
 Take account of opening angle

# Tall units 168.8 cm high

Carcase depth 55.5 cm (standard)

■ = Models also available in 34/45.5/61 cm carcass depth (Order no.: ... replace ... 55 ... with 34/45/61)  
 □ = Models also available in 45.5/61 cm carcass depth (order no.: replace ... 55 ... with 45/61)  
 ▲ = Types also available with 61 cm carcass depth (order no.: ... replace ... 55 ... with 61)

Order no.  
W H D

Hinge side:	Carcass depth	Price groups														
		1	2	3	4	5	6	7	8	9						
R/L ▲	776	78	GVP	50	16	55	01	1851	1868	1918	2012	2056	2087	2148	2363	-
								1939	1957	2013	2157	2214	2246	2316	2548	-
R/L ▲	776	78	GVP	100	16	55	01	3689	3720	3820	4011	4102	4161	4283	4711	-
R/L ▲	776	78	GV	50	16	55	01	1595	1609	1660	1761	1806	1835	1895	2085	-
R/L ▲	776	78	GV	60	16	55	01	1673	1692	1751	1898	1957	1989	2056	2262	-
R/L ▲	776	78	GVPS	60	16	55		1271	1287	1343	1503	1558	1593	1664	1830	-
R/L ▲	776	78	GVT	50	16	55	01	762	774	827	959	1003	1035	1094	1203	-
R/L ▲	776	78	GVT	60	16	55	01	818	833	893	1072	1129	1160	1232	1355	-
 The adjustable shelves will be delivered as a separate package.																
R/L ▲	776	78	GVPT	50	16	55	01	795	808	860	993	1038	1068	1129	1242	-
R/L ▲	776	78	GVPT	60	16	55	01	852	866	925	1107	1162	1196	1268	1395	-
 The adjustable shelves will be delivered as a separate package.																
R/L □	776	78	GB	30	16	55	01	328	341	392	477	528	557	618	680	-
R/L □	776	78	GB	40	16	55	01	328	341	392	477	528	557	618	680	-
R/L □	776	78	GB	45	16	55	01	328	341	392	477	528	557	618	680	-
R/L □	776	78	GB	50	16	55	01	328	341	392	477	528	557	618	680	-
R/L □	776	78	GB	60	16	55	01	328	341	392	477	528	557	618	680	-
R/L □	1686	78	GB	30	16	55	70	410	422	474	557	608	639	700	770	-
R/L □	1686	78	GB	40	16	55	70	410	422	474	557	608	639	700	770	-
R/L □	1686	78	GB	45	16	55	70	410	422	474	557	608	639	700	770	-
R/L □	1686	78	GB	50	16	55	70	410	422	474	557	608	639	700	770	-
R/L □	1686	78	GB	60	16	55	70	410	422	474	557	608	639	700	770	-
 Width 30, 40, 45, 50, 60 Not available for: ALUELEMENTS, ATLANTA-B, ATLANTA-S, BERGEN, CASTELLO, CHALET-B, CHALET-S, CHICAGO, FRAME, LUGANO, LUX-B, MIAMI, MODENA, MUNICH, NEVADA, NOBEL-B, NOBEL-S, ORLANDO-B, ORLANDO-S, OSLO 15, PADUA, SOFIE-B, SOFIE-S, TESSIN 15, TIM 15, VINO, VIVA, YORK-B, YORK-S																
R/L ▲	776	78	GB	40	16	55	11	514	528	579	664	714	743	805	886	-
R/L ▲	776	78	GB	45	16	55	11	514	528	579	664	714	743	805	886	-
R/L ▲	776	78	GB	50	16	55	11	514	528	579	712	756	788	847	932	-
R/L ▲	776	78	GB	60	16	55	11	553	568	626	808	864	897	969	1066	-
 Optional accessories HW HS Holder for vacuum cleaner hose or PET storage pocket (for screwing on), anthracite HW UTB Utensils box, e.g. for storing towels, cleaning cloths, etc. (for screwing on), anthracite																

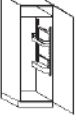
## Tall units 168.8 cm high

Carcase depth 55.5 cm (standard)

■ = Models also available in 34/45.5/61 cm carcass depth (Order no.: ... replace ... 55 ... with 34/45/61)  
 □ = Models also available in 45.5/61 cm carcass depth (order no.: replace ... 55 ... with 45/61)  
 ▲ = Types also available with 61 cm carcass depth (order no. ... replace ... 55 ... with 61)


Order no.  
W H D

		Price groups								
Hinge side:	Carcass depth	1	2	3	4	5	6	7	8	9
		R/L ▲	597	608	661	743	795	826	886	975
R/L ▲	597	608	661	743	795	826	886	975	-	
R/L ▲	597	608	661	793	836	869	929	1022	-	
R/L ▲	633	651	744	888	946	977	1048	1153	-	

**1686**  **Broom cupboard**  
 1 door 168.6 cm  
 1 fixed shelf  
 1 hook rail with 5 hooks, anthracite  
 Modular interior partitioning system, consisting of:  
 1 set of attachment rails, anthracite  
 1 large 3-side tray with rail, anthracite  
 1 carrier box for cleaning materials with carrier rails, anthracite  
 1 hook rail with 5 hooks, anthracite  
 All fronts include a tightening fitting



<b>GB</b>	<b>40</b>	<b>16</b>	<b>55</b>	<b>71</b>	R/L ▲	597	608	661	743	795	826	886	975	-
<b>GB</b>	<b>45</b>	<b>16</b>	<b>55</b>	<b>71</b>	R/L ▲	597	608	661	743	795	826	886	975	-
<b>GB</b>	<b>50</b>	<b>16</b>	<b>55</b>	<b>71</b>	R/L ▲	597	608	661	793	836	869	929	1022	-
<b>GB</b>	<b>60</b>	<b>16</b>	<b>55</b>	<b>71</b>	R/L ▲	633	651	744	888	946	977	1048	1153	-

 **Optional accessories**  
**HW HS** Holder for vacuum cleaner hose or PET storage pocket (for screwing on), anthracite  
**HW UTB** Utensils box, e.g. for storing towels, cleaning cloths, etc. (for screwing on), anthracite

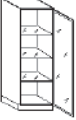
## Tall units 168.8 cm high with glass fronts

Carcass depth 55.5 cm (standard)

■ = Models also available in 34/45.5/61 cm carcass depth (Order no.: ... replace ... 55 ... with 34/45/61)

Order no.  
W H D

		Glass groups					
Hinge side:	Carcass depth	G1	G2	G2S	G5S	G6	
		R/L ■	-	-	1017	1189	1401
R/L ■	-	-	1041	1218	1425		
R/L ■	-	-	1065	1247	1449		

**1686**  **Crockery cupboard with glass front**  
 -neutral-  
 1 glass door 168.8 cm  
 3 adjustable glass shelves  
 and 1 additional adjustable glass shelf for individual positioning

34.0	45.5	55.5	61.0
------	------	------	------

<b>GGGD</b>	<b>45</b>	<b>16</b>	<b>55</b>	<b>70</b>	R/L ■	-	-	1017	1189	1401
<b>GGGD</b>	<b>50</b>	<b>16</b>	<b>55</b>	<b>70</b>	R/L ■	-	-	1041	1218	1425
<b>GGGD</b>	<b>60</b>	<b>16</b>	<b>55</b>	<b>70</b>	R/L ■	-	-	1065	1247	1449

G 1	G 2	G 2S
Config. of glass front elements	G1 AKTIV/glass frame	G2 Design front
G 5	G 5S	G 6
G2S aluminium, framed glass door	G5S aluminium, door with mullion	G6 NEW SALON

## Additional equipment

Order no.  
W H D

		Decor groups								
Hinge side:	Carcass depth	M10	M20	M30	M40	M50	M60	M70	M80	M90
		R/L ■	-	-	-	-	1646	-	1646	1646

**Surcharge for tall cabinets with glass fronts inside and exterior in the same design**  
 available in decor groups:  
 S/B/H/MP/F/Z

**IDF-G**





M 10	M 20	M 30	M 40	M 50
K M10 laminate				B M50 Velvet lacquer S M50 microstructure lacquer

M 60	M 70	M 80	M 90
	F M70 veneer / oak / walnut Z M70 Veneer / Bavaria	H M80 high gloss-Lacquer MP M80 laqué mat Premium	



# Tall units 168.8 cm high with roller shutter

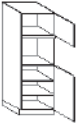
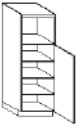
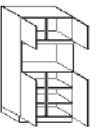
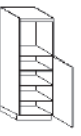
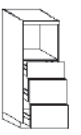
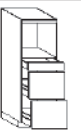
The useable inside depth (bare dimension) for the following carcass depths is  
 36.1 cm – bare dimension 26.5 cm / 47.7 cm – bare dimension 38.1 cm  
 57.7 cm – bare dimension 48.1 cm / 63.2 cm – bare dimension 53.6 cm  
 ▲ = Types also available with 63.2 cm carcass depth (order no. ... replace ... 58 ... with 63)

		Order no. W H D	Hinge side: Carcass depth	Decor groups								
				M10	M20	M30	M40	M50	M60	M70	M80	M90
	<b>Tall unit with roller shutter 168,8 cm high</b> Roller shutter stainless steel decor 5 adjustable shelves 1 structural shelf 3 sockets	<b>GJG 60 16 58 77</b>	▲	1542	-	-	-	3601	-	4256	-	-
	<i>No visible sides possible in other decor groups</i>											
		<b>GJG 60 16 48 77</b>		1503	-	-	-	3328	-	3894	-	-
<i>No visible sides possible in other decor groups</i>												
	<b>Tall unit with roller shutter 168,8 cm high</b> Roller shutters black laminate 5 adjustable shelves 1 structural shelf 3 sockets	<b>GJG 60 16 58 78</b>	▲	1650	-	-	-	3710	-	4365	-	-
	<i>No visible sides possible in other decor groups</i>											
		<b>GJG 60 16 48 78</b>		1611	-	-	-	3437	-	4003	-	-
<i>No visible sides possible in other decor groups</i>												
	<b>Tall unit SMARTGLAS roller shutters 168,8 cm high 57,7 cm deep</b> 4 adjustable shelves 1 structural shelf 3 sockets	<b>GJSGG60 16 58</b>	▲	3179	-	-	-	5237	-	5893	-	-
	<i>Panel, guide profile and handle in the same colour as the roller shutter optional accessory: only TAB-A**45 can be used as a pull-out shelf, and only 577 mm deep No visible sides possible in other decor groups</i>											
		<b>GJSGG60 16 48</b>		3140	-	-	-	4965	-	5530	-	-
<i>No visible sides possible in other decor groups</i>												
<b>M 10</b>		<b>M 20</b>		<b>M 30</b>		<b>M 40</b>		<b>M 50</b>				
Roller shutter unit K M10 laminate								B M50 Velvet Lacquer S Microstructure lacquer				
<b>M 60</b>		<b>M 70</b>		<b>M 80</b>		<b>M 90</b>						
		F M70 veneer / oak / walnut Z M70 Veneer / Bavaria										
	<b>Pull-out shelf with guide rails</b> With locking function, full pull-out „push to open“, shelf from decor group K For carcass width 45 cm, 50 cm, 60 cm For carcass width 80 cm, 90 cm for carcass depths 45.5 cm and 55.5 cm  Load-bearing capacity depth 55.5 cm: 35 kg Load-bearing capacity depth 45.5 cm: 35 kg Load-bearing capacity depth 55.5 cm: 35 kg Load-bearing capacity depth 45.5 cm: 35 kg Load-bearing capacity depth 55.5 cm: 35 kg Load-bearing capacity depth 45.5 cm: 35 kg Load-bearing capacity depth 55.5 cm: 30 kg Load-bearing capacity depth 45.5 cm: 30 kg Load-bearing capacity depth 55.5 cm: 30 kg Load-bearing capacity depth 45.5 cm: 30 kg	<b>Important:</b> When installing in units with hinged doors always take wide angle hinges <b>SA-90155E3</b> into consideration.										
	<b>TAB-AZ45 55</b>			220	-	-	-	-	-	-	-	-
	<b>TAB-AZ45 45</b>			220	-	-	-	-	-	-	-	-
	<b>TAB-AZ50 55</b>			225	-	-	-	-	-	-	-	-
	<b>TAB-AZ50 45</b>			225	-	-	-	-	-	-	-	-
	<b>TAB-AZ60 55</b>			234	-	-	-	-	-	-	-	-
	<b>TAB-AZ60 45</b>			234	-	-	-	-	-	-	-	-
	<b>TAB-AZ80 55</b>			282	-	-	-	-	-	-	-	-
	<b>TAB-AZ80 45</b>			282	-	-	-	-	-	-	-	-
	<b>TAB-AZ90 55</b>			298	-	-	-	-	-	-	-	-
	<b>TAB-AZ90 45</b>			298	-	-	-	-	-	-	-	-

## Appliance unit 168.8 cm high for microwave / oven

Carcase depth 55.5 cm (standard)

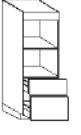
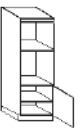
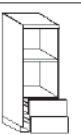
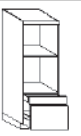
▲ = Types also available with 61 cm carcass depth (order no. ... replace ... 55 ... with 61)

				Order no.		Hinge side:	Carcass depth	Price groups												
				W	H			D	1	2	3	4	5	6	7	8	9			
386 776		<b>Appliance unit</b> 1 door 38.6 cm 1 panel 1 appliance aperture 36.2 - 50 cm 1 door 77.6 cm 2 adjustable shelves	36,2-50,0  78	GO	60	16	55	10	1	R/L	▲	423	444	519	660	750	796	873	960	-
				GO	60	16	55	10	1A	R/L	▲	423	444	519	660	750	796	873	960	-
1166		<b>Appliance unit</b> 1 panel 1 appliance aperture 36.2 - 50 cm 1 door 116.6 cm 3 adjustable shelves	36,2-50,0	GO	60	16	55	10		R/L	▲	407	421	481	570	608	639	702	772	-
386 776		<b>Appliance unit</b> 2 doors 38.6 cm 1 panel 1 appliance aperture 46.0 - 48.0 cm 2 doors 77.6 cm 2 adjustable shelves	46,0-48,0  78	GO	90	16	55	10			▲	710	737	841	997	1064	1115	1229	1352	-
				GO	90	16	55	10	A		▲	710	737	841	997	1064	1115	1229	1352	-
1036		<b>Appliance unit</b> 1 panel 1 appliance aperture 58.0 - 59.5 cm 1 door 103.6 cm 3 adjustable shelves	58,0-59,5	GO	60	16	55	20	X	R/L	▲	407	421	481	570	608	639	702	772	-
256 386 386		<b>Appliance unit</b> 1 panel 1 appliance aperture 58.0 - 59.5 cm 1 pull-out 25.6 cm 2 pull-outs 38.6 cm	58,0-59,5	GO	60	16	55	20	X3		▲	923	940	995	1075	1112	1144	1208	1329	-
126 451 451		<b>Appliance unit</b> 1 panel 1 appliance aperture 58.0 - 59.5 cm 1 drawer 12.6 cm 2 pull-outs 45.1 cm	58,0-59,5	GO	60	16	55	20	X8		▲	923	940	995	1075	1112	1144	1208	1329	-

## Appliance unit 168.8 cm high for microwave / oven Double aperture

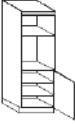


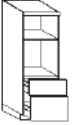


Carcass depth 55.5 cm (standard)

▲ = Types also available with 61 cm carcass depth (order no. ... replace ... 55 ... with 61)

256 386		<b>Appliance unit</b> 1 panel 1 appliance aperture 45.0 cm 1 appliance aperture 45.0 cm 1 pull-out 25.6 cm 1 pull-out 38.6 cm	45,0	GO	60	16	55	09	2	R/L	▲	737	756	812	897	932	965	1027	1130	-
			45,0																	
516		<b>Appliance unit</b> 1 panel 1 appliance aperture 40.1 - 50.0 cm 1 appliance aperture 58.0 - 59.5 cm 1 door 51.6 cm 1 adjustable shelf	40,1-50,0  58,0-59,5	GO	60	16	55	28	X	R/L	▲	407	421	481	570	608	639	702	772	-
256 256		<b>Appliance unit</b> 1 panel 1 appliance aperture 40.1 - 50.0 cm 1 appliance aperture 58.0 - 59.5 cm 2 pull-outs 25.6 cm	40,1-50,0	GO	60	16	55	28	X2		▲	737	756	812	897	932	965	1027	1130	-
			58,0-59,5																	
126 386		<b>Appliance unit</b> 1 panel 1 appliance aperture 40.1-50 cm 1 appliance aperture 58.0 - 59.5 cm 1 drawer 12.6 cm 1 pull-out 38.6 cm	40,1-50,0  58,0-59,5	GO	60	16	55	28	X3		▲	700	716	774	863	903	931	995	1095	-

# Appliance unit 168.8 cm high for microwave / oven Double aperture

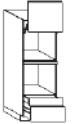


Carcase depth 55.5 cm (standard)

		Price groups																	
		1	2	3	4	5	6	7	8	9									
646	 <p><b>Appliance unit</b> 1 panel 1 appliance aperture 30.8 - 40 cm 1 appliance aperture 58.0 - 59.5 cm 1 door 64.6 cm 2 adjustable shelves</p>	 	GO	60	16	55	27	X	R/L	▲	407	421	481	570	608	639	702	772	-
256 386	 <p><b>Appliance unit</b> 1 panel 1 appliance aperture 30.8 - 40 cm 1 appliance aperture 58.0 - 59.5 cm 1 pull-out 25.6 cm 1 pull-out 38.6 cm</p>	 	GO	60	16	55	27	X2	R/L	▲	737	756	812	897	932	965	1027	1130	-

# Appliance unit 168.8 cm high for microwave / oven Lifting door / aperture

Carcase depth 55.5 cm (standard)





















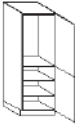



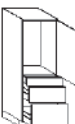




▲ = Types also available with 61 cm carcase depth (order no. ... replace ... 55 ... with 61)

126 516 126 256	 <p><b>Appliance unit</b> 1 panel 12.6 cm 1 lifting door with front 51.6 cm 1 panel 1 appliance aperture 58.0 - 59.5 cm 1 drawer 12.6 cm 1 pull-out 25.6 cm</p>		GO	60	16	55	36	X6	R/L	▲	809	823	855	982	1035	1055	1136	1250	-
	 <b>Appliance unit with compensation door above appliance aperture</b>		GO	60	16	55	36	X6A	R/L	▲	809	823	855	982	1035	1055	1136	1250	-

# Appliance unit 168.8 cm high for refrigerator/freezer

Carcase depth 55.5 cm (standard)


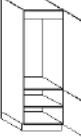

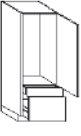


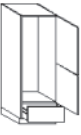
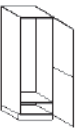


▲ = Types also available with 61 cm carcase depth (order no. ... replace ... 55 ... with 61)

906 256	 <p><b>Appliance unit</b> 1 panel 1 appliance aperture 36.2 - 50 cm 1 integrated appliance aperture 88 cm 1 door 90.6 cm 1 pull-out 25.6 cm</p>	 	GOI	60	16	55	11	X	R/L	▲	506	531	604	802	862	909	996	1096	-
	 <i>Important: Observe the appliance manufacturers' permitted front weights for fixed door assembly. See overview of models for front weights.</i>																		
	 <b>Appliance unit with integrated ventilation</b>		GOIB	60	16	55	11	X	R/L	▲	523	548	621	818	879	926	1013	1114	-
1036	 <p><b>Appliance unit</b> 1 panel 1 appliance aperture 58.0 - 59.5 cm 1 integrated appliance aperture 88 cm 1 door 103.6 cm</p>	 	GOI	60	16	55	21	X	R/L	▲	407	421	481	570	608	639	702	772	-
	 <i>Important: Observe the appliance manufacturers' permitted front weights for fixed door assembly. See overview of models for front weights.</i>																		
	 <b>Appliance unit with integrated ventilation</b>		GOIB	60	16	55	21	X	R/L	▲	422	438	496	586	624	654	719	791	-
1063	 <p><b>Appliance unit</b> 1 panel 1 appliance aperture 36.0 - 45 cm 1 integrated appliance aperture 102.5 cm 1 door 106.3 cm</p>	 	GOI	60	16	55	12	X4	R/L	▲	407	421	481	570	608	639	702	772	-
	 <b>Width 60 Not available for: MIAMI, VIVA</b>																		
	 <i>Important: Observe the appliance manufacturers' permitted front weights for fixed door assembly. See overview of models for front weights.</i>																		
1166	 <p><b>Appliance unit</b> 1 panel 1 appliance aperture 36.2 - 50 cm 1 integrated appliance aperture 103 cm 1 door 116.6 cm</p>	 	GOI	60	16	55	12	X	R/L	▲	407	421	481	570	608	639	702	772	-
	 <i>Important: Observe the appliance manufacturers' permitted front weights for fixed door assembly. See overview of models for front weights.</i>																		
	 <b>Appliance unit with integrated ventilation</b>		GOIB	60	16	55	12	X	R/L	▲	422	438	496	586	624	654	719	791	-
906 776	 <p><b>Appliance unit</b> 1 integrated appliance aperture 88 cm 1 door 90.6 cm 1 door 77.6 cm 2 adjustable shelves</p>	 	GI	60	16	55	30	X	R/L	▲	423	444	519	660	750	796	873	960	-
	 <i>Important: Observe the appliance manufacturers' permitted front weights for fixed door assembly. See overview of models for front weights.</i>																		
906 126 256 386	 <p><b>Appliance unit</b> 1 integrated aperture 88 cm 1 door 90.6 cm 1 drawer 12.6 cm 1 pull-out 25.6 cm 1 pull-out 38.6 cm</p>	 	GI	60	16	55	30	X3	R/L	▲	900	921	993	1136	1226	1272	1349	1484	-
	 <i>Important: Observe the appliance manufacturers' permitted front weights for fixed door assembly. See overview of models for front weights.</i>																		
	 <b>Appliance unit with integrated ventilation</b>		GIB	60	16	55	30	X3	R/L	▲	917	938	1010	1153	1243	1289	1366	1503	-

# Appliance unit 168.8 cm high for refrigerator/freezer

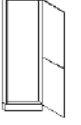
Carcase depth 55.5 cm (standard)

▲ = Types also available with 61 cm carcass depth (order no. ... replace ... 55 ... with 61)

		Order no.			Hinge side:	Carcass depth	Price groups																		
		W	H	D			1	2	3	4	5	6	7	8	9										
 <p><b>Appliance unit</b> 1 integrated appliance aperture 88 cm 1 door 90.6 cm 2 pull-outs 38.6 cm</p> <p><b>Appliance unit with integrated ventilation</b></p>	<p>906 386 386</p>	<p>88,0</p>	GI	60	16	55	30	X2	R/L ▲	759	776	851	987	1075	1121	1198	1318	-							
			<p>Important: Observe the appliance manufacturers' permitted front weights for fixed door assembly. See overview of models for front weights.</p>										GIB	60	16	55	30	X2	R/L ▲	776	792	867	1003	1092	1138
 <p><b>Appliance unit</b> 1 integrated appliance aperture 103 cm 1 door 116.6 cm 1 door 51.6 cm 1 adjustable shelf</p> <p><b>Appliance unit with integrated ventilation</b></p>	<p>1166 516</p>	<p>103,0</p>	GI	60	16	55	40	X	R/L ▲	423	444	519	660	750	796	873	960	-							
			<p>Important: Observe the appliance manufacturers' permitted front weights for fixed door assembly. See overview of models for front weights.</p>										GIB	60	16	55	40	X	R/L ▲	440	461	536	676	767	813
 <p><b>Appliance unit</b> 1 integrated appliance aperture 103 cm 1 door 116.6 cm 2 pull-outs 25.6 cm</p> <p><b>Appliance unit with integrated ventilation</b></p>	<p>1166 256 256</p>	<p>103,0</p>	GI	60	16	55	40	X2	R/L ▲	759	776	851	987	1075	1121	1198	1318	-							
			<p>Important: Observe the appliance manufacturers' permitted front weights for fixed door assembly. See overview of models for front weights.</p>										GIB	60	16	55	40	X2	R/L ▲	776	792	867	1003	1092	1138
 <p><b>Appliance unit</b> 1 integrated aperture 103 cm 1 door 116.6 cm 1 drawer 12.6 cm 1 pull-out 38.6 cm</p> <p><b>Appliance unit with integrated ventilation</b></p>	<p>1166 126 386 386</p>	<p>103,0</p>	GI	60	16	55	40	X3	R/L ▲	718	739	813	955	1045	1090	1170	1287	-							
			<p>Important: Observe the appliance manufacturers' permitted front weights for fixed door assembly. See overview of models for front weights.</p>										GIB	60	16	55	40	X3	R/L ▲	734	755	829	971	1061	1106
 <p><b>Appliance unit</b> 1 integrated appliance aperture 122.5 cm 1 door 129.6 cm 1 pull-out 38.6 cm</p> <p><b>Appliance unit with integrated ventilation</b></p>	<p>1296 386</p>	<p>122,5</p>	GI	60	16	55	50	X	R/L ▲	506	531	604	802	862	909	996	1096	-							
			<p>Important: Observe the appliance manufacturers' permitted front weights for fixed door assembly. See overview of models for front weights.</p>										GIB	60	16	55	50	X	R/L ▲	523	548	621	818	879	926
 <p><b>Appliance unit</b> 1 integrated appliance aperture 122.5 cm 1 door 38.6 cm 1 door 90.6 cm 1 pull-out 38.6 cm</p>	<p>386 906 386</p>	<p>122,5</p>	GI	60	16	55	55	05	R/L ▲	532	555	630	825	887	932	1020	1122	-							
			<p>Important: Observe the appliance manufacturers' permitted front weights for fixed door assembly. See overview of models for front weights.</p>																						
 <p><b>Appliance unit</b> 1 integrated appliance aperture 140 cm 1 door 77.6 cm connected to 1 door 64.6 cm 1 drawer 25.6 cm</p>	<p>776 646 256</p>	<p>140,0</p>	GI	60	16	55	62	01	R/L ▲	506	531	604	802	862	909	996	1096	-							
			<p>Important: Observe the appliance manufacturers' permitted front weights for fixed door assembly. See overview of models for front weights.</p>																						
 <p><b>Appliance unit</b> 1 integrated aperture 140 cm 1 door 84.1 cm attached to 1 door 84.1 cm</p>	<p>841 841</p>	<p>140,0</p>	GI	60	16	55	62	X8	R/L ▲	423	444	519	660	750	796	873	960	-							
			<p>Width 60 Not available for: MIAMI, VIVA</p> <p>Important: Observe the appliance manufacturers' permitted front weights for fixed door assembly. See overview of models for front weights.</p>																						
 <p><b>Appliance unit</b> 1 integrated appliance aperture 144.6 cm 1 door 90.6 cm 1 door 77.6 cm</p>	<p>906 711</p>	<p>144,6</p>	GI	60	16	55	68	01	R/L ▲	423	444	519	660	750	796	873	960	-							
			<p>Important: Observe the appliance manufacturers' permitted front weights for fixed door assembly. See overview of models for front weights.</p>																						
 <p><b>Appliance unit</b> 1 integrated appliance aperture 144.6 cm 1 door 38.6 cm 1 door 129.6 cm</p>	<p>386 1296</p>	<p>144,6</p>	GI	60	16	55	68	03	R/L ▲	417	435	492	587	625	658	721	793	-							
			<p>Important: Observe the appliance manufacturers' permitted front weights for fixed door assembly. See overview of models for front weights.</p>																						

## spacefitter frame 168.8 cm high

Carcass depth 55.5 cm (standard)


 <p><b>Tall unit spacefitter frame</b> 1 door 90.6 cm connected to 1 door 77.6 cm Carcass depth 10 cm For recess cladding</p>	<p>906 776</p>	<p>78</p>	GPR	30	16	10	01	R/L	230	239	275	359	370	391	435	479	-
			GPR	40	16	10	01	R/L	230	239	275	359	370	391	435	479	-
			GPR	45	16	10	01	R/L	230	239	275	359	370	391	435	479	-
			GPR	50	16	10	01	R/L	230	239	275	384	400	422	465	512	-
			GPR	60	16	10	01	R/L	258	268	308	448	477	498	549	604	-

# Front filler 168.8 cm high


Carcase depth 55.5 cm (standard)

Order no.  
W H D


Hinge side:	Carcase depth	Price groups									
		1	2	3	4	5	6	7	8	9	
		<b>Lightbulb icon</b> Cut edge at top for: MIAMI, VINO <b>Note:</b> Models with horizontal veneer graining can only be supplied with 2-part front trim panel									
		GP 10 16	85	85	93	144	144	144	157	173	-
		GP 20 16	92	92	109	170	170	170	182	200	-
		GPW 90 16	124	124	137	200	200	200	214	235	-
		<b>Lightbulb icon</b> Cut edge at top for: MIAMI, VINO <b>Note:</b> Models with horizontal veneer graining can only be supplied with 2-part front trim panel									
		GPW 135 16	124	124	137	200	200	200	214	235	-
		<b>Scissors icon</b> Not available for: ALU TEC RP									
		<b>Lightbulb icon</b> Cut edge at top for: MIAMI, VINO <b>Note:</b> Models with horizontal veneer graining can only be supplied with 2-part front trim panel									



**Tall unit front filler**  
168.8 cm high  
3.5 - 10 cm  
10.1 - 20 cm





**Tall unit corner filler 90°**  
168.8 cm high  
As corner connection between 2 tall units  
Without shelf, 9.5 x 9.5 cm





**Tall unit corner filler 135°**  
168.8 cm high  
For cladding blind corners  
Planning dimensions 25.9 x 25.9 cm

## Back cladding 168.8 cm high with screw-fitted fronts

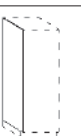



		Order no. W H D		Price groups										
				Hinge side:	Carcase depth	1	2	3	4	5	6	7	8	9
 <p><b>Back cladding</b> For tall units, 168.8 cm high Carcase material with screw-fitted fronts, 90.6 cm and 77.6 cm Only available in grid sizes</p>	per 10 cm Width													
	<b>GVF 16 02</b>				65	68	71	89	91	95	101	111	-	
 <b>Important!</b> Plinth panel is supplied loose.														

## Back cladding 168.8 cm high

		Order no. W H D		Decor groups										
				Hinge side:	Carcase depth	M10	M20	M30	M40	M50	M60	M70	M80	M90
 <p><b>Back cladding</b> For tall units, 168.8 cm high 16 mm thick</p>	per 10 cm Width													
	<b>GVK 16</b>				27,50	48	66	87	87	87	87	87	-	
 <p><b>Tall unit background filler</b> Width: 20 cm For fitting flush with carcass 168.8 cm high</p>														
	<b>GPSL 00 16</b>				45	53	103	138	138	138	138	138	-	

M 10	M 20	M 30	M 40	M 50
K M10 laminate	D M20 Laminate decor	I M30 RESOPAL PRO super matt IH M30 HPL PRO PW M30 PRIMEWOOD/Basic Veneer	A M40 DIRECTLACK matt L M40 DIRECTLACK high-gloss	B M50 Velvet lacquer S M50 microstructure lacquer
M 60	M 70	M 80	M 90	
QH M60 SMARTGLAS high-gloss QM M60 SMARTGLAS satin-finish	F M70 veneer / oak / walnut Z M70 Veneer / Bavaria	C1 M80 FENIX stainless-steel look H M80 high gloss-Lacquer MP M80 laqué mat Premium		

## Visible sides / increased side depth 168.8 cm high

		Order no. W H D		Decor groups										
				Hinge side:	Carcase depth	M10	M20	M30	M40	M50	M60	M70	M80	M90
 <p><b>Tall unit visible side</b></p> <p>55.5 cm side depth Fixed dimension, not variable 57.5 cm side depth Fixed dimension, not variable 60.5 cm side depth Fixed dimension, not variable 61 cm side depth Fixed dimension, not variable</p>	 <b>Important!</b> Installation instead of a normal unit side. Only available in the listed side depths. For other dimensions, use GSVT...													
	<b>GSV 16</b>	R/L		0	0	126	126	169	169	220	279	-		
	<b>GSV 16 5</b>	R/L		0	0	126	126	169	169	220	279	-		
	<b>GSV 16 6</b>	R/L		0	0	126	126	169	169	220	279	-		
	<b>GSV 16 6 1</b>	R/L		0	0	126	126	169	169	220	279	-		
 <p><b>Tall unit increased side depth</b></p> <p>from 61.1 cm up to 90 cm side depth Up to 60.9 cm side depth</p>	 <b>Important!</b> Installation instead of a normal unit side.													
	<b>GSVT 16</b>	R/L		88	118	278	278	370	370	480	586	-		
	<b>GSVT 16 6</b>	R/L		45	58	187	187	249	249	322	408	-		

M 10	M 20	M 30	M 40	M 50
K M10 laminate	D M20 Laminate decor	I M30 RESOPAL PRO super matt IH M30 HPL PRO PW M30 PRIMEWOOD/Basic Veneer	A M40 DIRECTLACK matt L M40 DIRECTLACK high-gloss	B M50 Velvet lacquer P M50 Soft lacquer RH M50 Velvet lacquer wood texture RW M50 Velvet lacquer sparkle effect S M50 microstructure lacquer
M 60	M 70	M 80	M 90	
QH M60 SMARTGLAS high-gloss QM M60 SMARTGLAS satin-finish	F M70 veneer / oak / walnut V M70 Velvet lacquer textured Z M70 Veneer / Bavaria	C1 M80 FENIX stainless-steel look H M80 high gloss-Lacquer MP M80 laqué mat Premium O M80 Veneered		





# Raised dishwashers

For carcass height 168.8 cm, carcass depth 55.5 cm

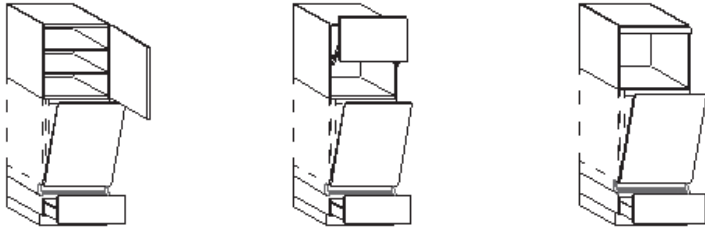
Pull-out panel at bottom 25.6 cm high

**Note:**

Do not plan at the end of a row. Only plan between tall units.

Always follow the assembly instructions from the appliance manufacturers.

▲ = Types also available with 61 cm carcass depth (order no. ... replace ... 55 ... with 61)



			Price groups											
Order no.			Hinge side:	Carcass depth	1	2	3	4	5	6	7	8	9	
W	H	D												
646		<b>Dresser unit above raised dishwasher</b> Height 66.3 cm 1 flap door 25.6 cm 2 adjustable shelves 1 vapour protector	A	60 66 55	R/L ▲	240	251	268	331	375	400	441	485	-
256 386		<b>Dresser unit with lifting door for microwave above</b> Height 66.3 cm 1 flap door 25.6 cm 1 lifting door with front 38.6 cm 1 vapour protector	ALT	60 66 55	▲	390	399	413	478	511	525	601	661	-
		<b>Dresser unit for microwave above</b> Height 66.3 cm 1 panel 1 appliance aperture 35 - 45 cm 1 vapour protector	AN	60 66 55 2	▲	190	191	200	209	209	228	247	272	-
				35,0-45,0		Not available for: ALU TEC RP								
776		<b>Base unit door, 77.6 cm</b> 59.6 cm wide As front panel for fully integrated dishwashers 86 cm high and pull-out fridges and freezers	UT	60 78 1		122	126	138	146	232	253	294	323	-
						Always order article DL 60 6 if a high-volume dishwasher has not been included in planning!								
		<b>Spacer strips for fully integrated dishwasher</b> Appliance height 82 cm 2 spacer strips Colour: Art Pepper 6 cm high	DL	60 6		32								
256		<b>Base for raised dishwasher (86 cm high)</b> with top shelf, 15.5 cm high 1 drawer with pull-out panel 25.6 cm, 45.5 cm deep angled at top 1 collection tray (available only in 60 cm width)	UGS	60 10 55 87	▲	276	290	320	378	412	439	480	528	-
						Not available for: ALU TEC RP								
						Important! Plan free-standing with 25 mm panels								
256		<b>Base for raised dishwasher (86 cm high)</b> only for dishwashers with VARIO HINGE with top shelf, 15.5 cm high 1 drawer with pull-out panel 25.6 cm not angled 45.5 cm deep 1 collection tray (available only in 60 cm width)	UGV	60 10 55 87	▲	276	290	320	378	412	439	480	528	-
						Important! Plan free-standing with 25 mm panels								

# Raised dishwashers

For carcass height 168.8 cm, carcass depth 55.5 cm

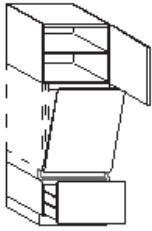
Pull-out panel at bottom 38.6 cm high

**Note:**

Do not plan at the end of a row. Only plan between tall units.

Always follow the assembly instructions from the appliance manufacturers.

▲ = Types also available with 61 cm carcass depth (order no. ... replace ... 55 ... with 61)



Order no. W H D		Hinge side: R/L	Carcass depth	Price groups										
				1	2	3	4	5	6	7	8	9		
516	<p><b>Dresser unit above raised dishwasher</b> Height 53.3 cm 1 door 51.6 cm 1 adjustable shelf 1 vapour protector</p>	A	60 53 55	R/L	▲	226	236	258	314	339	354	390	429	-
516	<p><b>Dresser unit with lifting door for microwave above raised dishwasher</b> Height 53.3 cm 1 lifting door with front 51.6 cm 1 vapour protector</p>	ALT	60 53 55		▲	384	391	410	467	483	495	562	618	-
	<p><b>Dresser unit for microwave above raised dishwasher</b> Height 53.3 cm 1 panel 1 appliance aperture 35 - 45 cm 1 vapour protector</p>	AN	60 53 55 2		▲	226	236	258	314	339	354	390	429	-
		<p>Not available for: ALU TEC RP</p>												
776	<p><b>Base unit door, 77.6 cm</b> 59.6 cm wide As front panel for fully integrated dishwashers 86 cm high and pull-out fridges and freezers</p>	UT	60 78 1			122	126	138	146	232	253	294	323	-
		<p>Always order article DL 60 6 if a high-volume dishwasher has not been included in planning!</p>												
	<p><b>Spacer strips for fully integrated dishwasher</b> Appliance height 82 cm 2 spacer strips Colour: Art Pepper 6 cm high</p>	DL	60 6			32								
386	<p><b>Base for raised dishwasher (86 cm high) with top shelf, 28.5 cm high</b> 1 pull-out 38.6 cm, 45.5 cm deep angled at top 1 collection tray (available only in 60 cm width)</p>	UGS	60 11 55 87		▲	285	298	326	389	419	445	485	534	-
		<p>Not available for: ALU TEC RP</p>												
		<p>Important! Plan free-standing with 25 mm panels</p>												
386	<p><b>Base for raised dishwasher (86 cm high) only for dishwashers with VARIO HINGE</b> with top shelf, 28.5 cm high 1 pull-out panel 38.6 cm, 45.5 cm deep not angled 1 collection tray (available only in 60 cm width)</p>	UGV	60 11 55 87		▲	285	298	326	389	419	445	485	534	-
		<p>Important! Plan free-standing with 25 mm panels</p>												

# Raised dishwashers

For carcass height 168.8 cm, carcass depth 55.5 cm

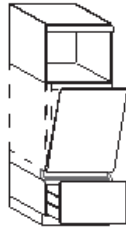
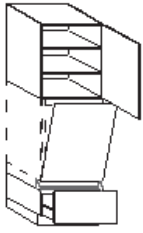
Pull-out panel at bottom 32.1 cm high

**Note:**

Do not plan at the end of a row. Only plan between tall units.

Always follow the assembly instructions from the appliance manufacturers.

▲ = Types also available with 61 cm carcass depth (order no. ... replace ... 55 ... with 61)



			Price groups											
Order no.			Hinge side:	Carcass depth	1	2	3	4	5	6	7	8	9	
W	H	D												
581		<b>Dresser unit above raised dishwasher</b> Height 59.8 cm 1 door 58.1 cm 1 adjustable shelf 1 vapour protector	A	60 60 55	R/L ▲	240	251	268	331	375	400	441	485	-
581		<b>Dresser unit with lifting door for microwave above raised dishwasher</b> Height 59.8 cm 1 lifting door with front 58.1 cm 1 vapour protector	ALT	60 60 55	▲	390	399	413	478	511	525	601	661	-
		<b>Dresser unit for microwave above raised dishwasher</b> Height 59.8 cm 1 panel 1 appliance aperture 35 - 45 cm 1 vapour protector	AN	60 60 55 2	▲	240	251	268	331	375	400	441	485	-
						Not available for: ALU TEC RP								
776		<b>Base unit door, 77.6 cm</b> 59.6 cm wide As front panel for fully integrated dishwashers 86 cm high and pull-out fridges and freezers	UT	60 78 1		122	126	138	146	232	253	294	323	-
						Always order article DL 60 6 if a high-volume dishwasher has not been included in planning!								
		<b>Spacer strips for fully integrated dishwasher</b> Appliance height 82 cm 2 spacer strips Colour: Art Pepper 6 cm high	DL	60 6		32								
321		<b>Base for raised dishwasher</b> with top shelf, 22.0 cm high 1 drawer with pull-out panel 32.1 cm, 45.5 cm deep, angled at top 1 collection tray (available only in 60 cm width)	UGS	60 15 55 871	▲	276	290	320	378	412	439	480	528	-
						Not available for: ALU TEC RP, MIAMI, VIVA								
						Important! Plan free-standing with 25 mm panels								
		<b>Base for raised dishwasher</b> only for dishwashers with VARIO HINGE with top shelf, 22.0 cm high 1 drawer with pull-out panel 32.1 cm, 45.5 cm deep, not chamfered 1 collection tray (available only in 60 cm width)	UGV	60 15 55 871	▲	276	290	320	378	412	439	480	528	-
						Not available for: MIAMI, VIVA								
						Important! Plan free-standing with 25 mm panels								
		<b>Vapour protector for raised dishwashers</b> Finish: metal to protect the fronts above	WSB-45			11								
			WSB-60			12								

# 6.4

## Tall units 181.8 cm

Tall units 181.8 cm high	XL 6.4.3-XL 6.4.6
Tall units 181.8 cm high with glass fronts	XL 6.4.6
Additional equipment	XL 6.4.6
Tall units 181.8 cm high with roller shutter	XL 6.4.7
Appliance unit 181.8 cm high for microwave / oven	XL 6.4.8
Appliance unit 181.8 cm high for microwave / oven Double aperture	XL 6.4.9
Appliance unit 181.8 cm high for microwave / oven Lifting door / aperture	XL 6.4.9
Appliance unit 181.8 cm high for refrigerator/freezer	XL 6.4.9-XL 6.4.11
Appliance unit 181.8 cm high for refrigerator/freezer Double aperture	XL 6.4.11
spacefitter frame 181.8 cm high	XL 6.4.12
Front filler 181.8 cm high	XL 6.4.12
Back cladding 181.8 cm high with screw-fitted fronts	XL 6.4.12
Back cladding 181.8 cm high	XL 6.4.13
Visible sides / increased side depth 181.8 cm high	XL 6.4.13
Shelf units 181.8 cm high	XL 6.4.14
Raised dishwashers For carcass height 181.8 cm, carcass depth 55.5 cm	XL 6.4.15
Raised dishwashers For carcass height 181.8 cm, carcass depth 55.5 cm	XL 6.4.16
Raised dishwashers For carcass height 181.8 cm, carcass depth 55.5 cm	XL 6.4.17
Raised dishwashers For carcass height 181.8 cm, carcass depth 55.5 cm	XL 6.4.18

### Legend:



Available with grip ledge N...



Not available with grip ledge N...



This symbol indicates which models are available



This symbol indicates which models are not available



wall-mounted units



available depths for wall-mounted units



Planning advice



This symbol illustrates which appliance units are delivered with integrated ventilation



Not available with „push-to-open“ fitting



Aperture height specifications



Available carcass depths 34/45.5/55.5/61.0 cm



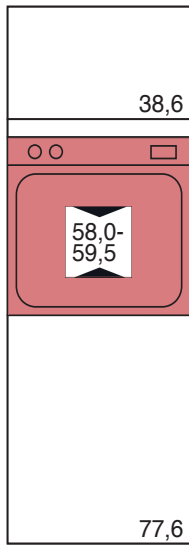
Available carcass depths 45.5/55.5/61.0 cm



Available carcass depths 55.5/61.0 cm

## Planning advice for appliance shelves with compensation panels or compensation door

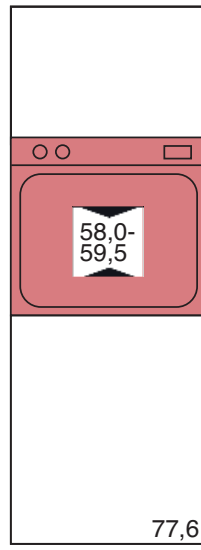
Height  
181,8 cm



GO60185520X

Door

Compensation  
panel



GO601820XA

Compensation lifting door  
38.6 cm + compensation panel

By changing the order number, the compensation panels above the appliance apertures can be replaced by a special-size door or lifting door.

Advantages:

- Full use can be made of the storage space above the appliance aperture
- Reduction of horizontal joints

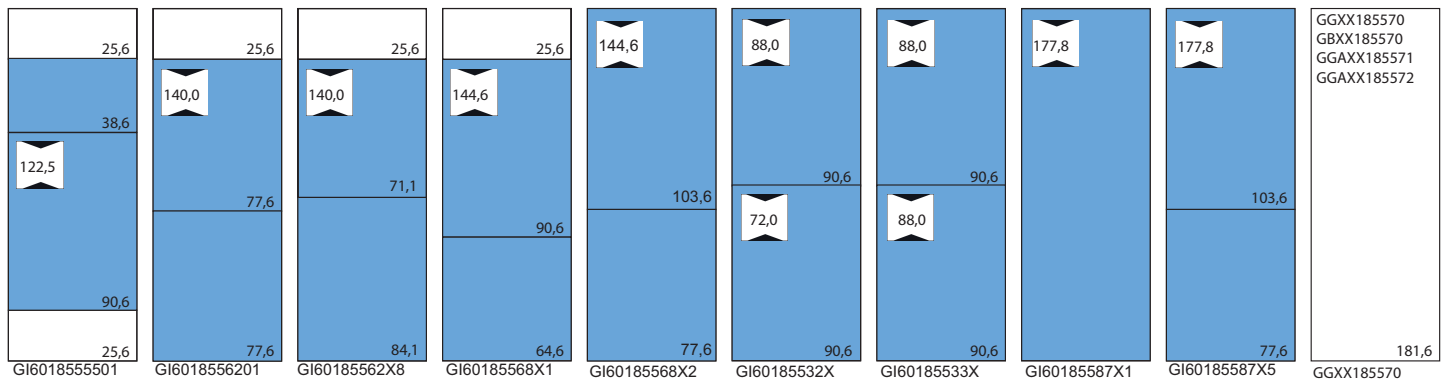
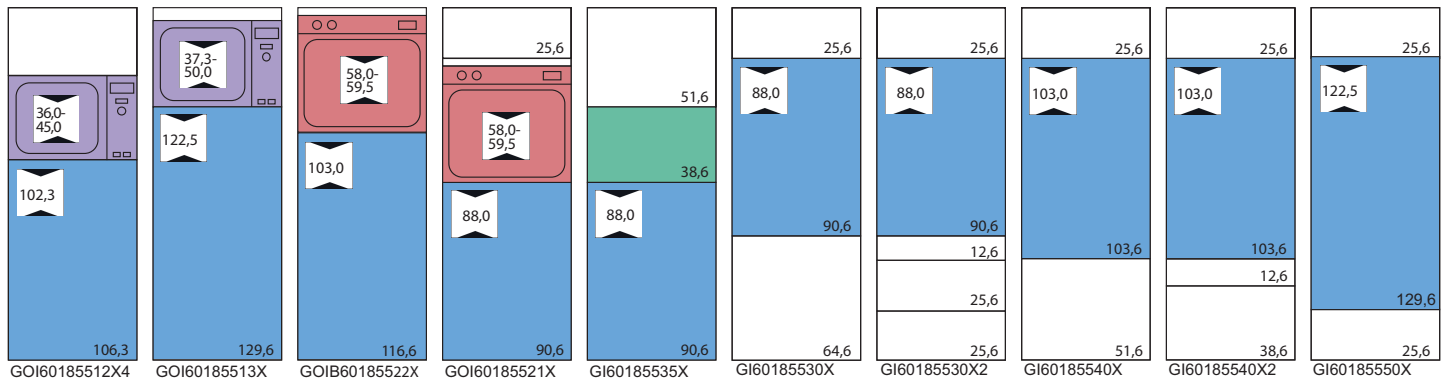
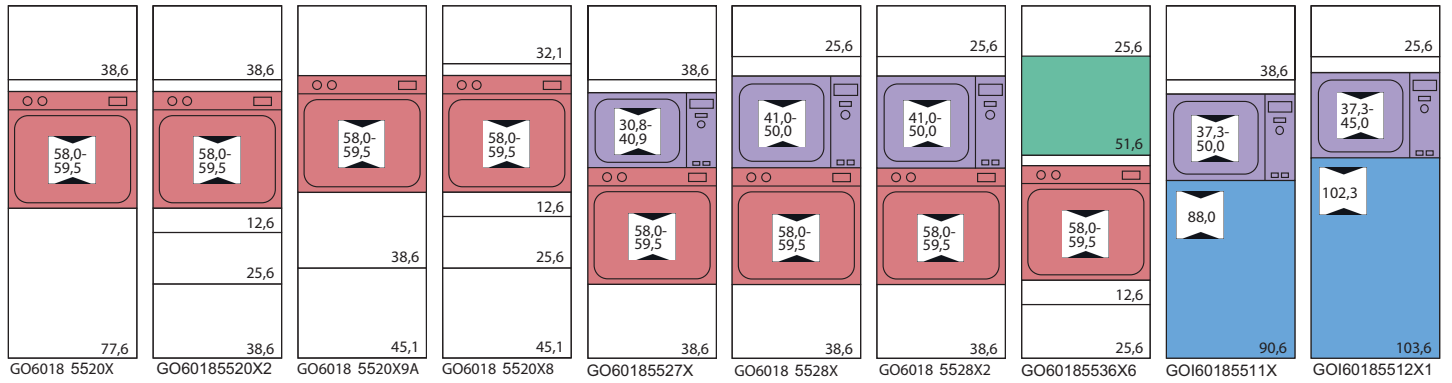
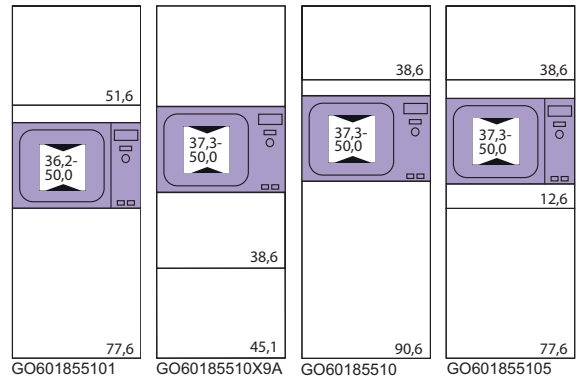
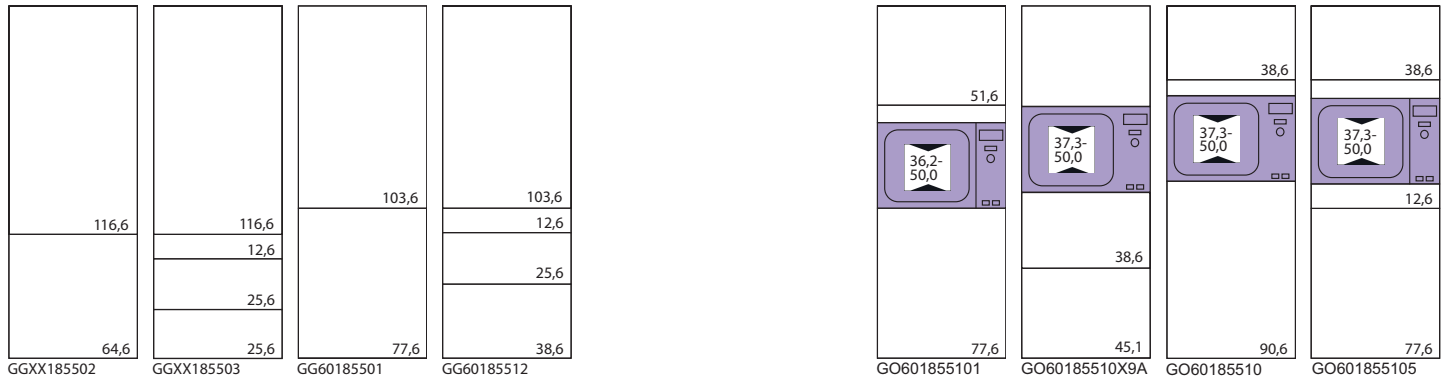


**Not available for models:  
MIAMI, VIVA**

# The most important tall unit types 181.8 cm high

Page XL 6.4.3	Page XL 6.4.3	Page XL 6.4.3	Page XL 6.4.3	Page XL 6.4.3	Page XL 6.4.3	Page XL 6.4.3	Page XL 6.4.3	Page XL 6.4.3
<b>GGs..185502</b> Unit widths: 25	<b>GVSTP..185502</b> Unit widths: 25	<b>GV..185502</b> Unit widths: 30/45	<b>GV..185570</b> Unit widths: 30/45	<b>GVP..185502</b> Unit widths: 30/45	<b>GVP..185570</b> Unit widths: 30/45	<b>GV..185502</b> Unit widths: 30/45/50/60	<b>GVP..185502</b> Unit widths: 30/45/50/60	<b>GVPS..1855</b> Unit widths: 60
Page XL 6.4.3	Page XL 6.4.3	Page XL 6.4.3	Page XL 6.4.4	Page XL 6.4.4	Page XL 6.4.4	Page XL 6.4.4	Page XL 6.4.4	Page XL 6.4.4
<b>GVT..185502</b> Unit widths: 50/60	<b>GVPT..185502</b> Unit widths: 50/60	<b>GG..185502</b> Unit widths: 30/40/45/50/60	<b>GG..185503</b> Unit widths: 30/40/45/50/60	<b>GG..185501</b> Unit widths: 30/40/45/50/60	<b>GGA..185501</b> Unit widths: 30/40/45/50/60	<b>GGA..185503</b> Unit widths: 30/40/45/50/60	<b>GG..185512</b> Unit widths: 30/40/45/50/60	<b>GG..185505</b> Unit widths: 30/40/45/50/60
Page XL 6.4.4	Page XL 6.4.4	Page XL 6.4.5	Page XL 6.4.5	Page XL 6.4.5	Page XL 6.4.5	Page XL 6.4.5	Page XL 6.4.5	Page XL 6.4.6
<b>GGA..185506</b> Unit widths: 30/40/45/50/60	<b>GG..185570</b> Unit widths: 30/40/45/50/60	<b>GGA..185571</b> Unit widths: 30/40/45/50/60	<b>GGA..185572</b> Unit widths: 30/40/45/50/60	<b>GB..185502</b> Unit widths: 30/40/45/50/60	<b>GB..185501</b> Unit widths: 30/40/45/50/60	<b>GB..185570</b> Unit widths: 30/40/45/50/60	<b>GB..185511</b> Unit widths: 40/45/50/60	<b>GGD..185570</b> Unit widths: 45/50/60
Page XL 6.4.7	Page XL 6.4.12	Page XL 6.4.12	Page XL 6.4.12	Page XL 6.4.12	Page XL 6.4.12	Page XL 6.4.12	Page XL 6.4.12	Page XL 6.4.14
<b>TAB-AZ..55</b> Unit widths: 45/50/60/80/90	<b>GPR..181002</b> Unit widths: 30/45/50/60	<b>GPR..181001</b> Unit widths: 30/45/50/60	<b>GP..18</b> Unit widths: 3,5-20	<b>GPW..18</b> Unit widths: 9,5x9,5	<b>GPW..18</b> Unit widths: 25,9x25,9	<b>GVF..03</b> Unit widths: 10-250	<b>GVF..02</b> Unit widths: 10-250	<b>GR..1858</b> Unit widths: 30/40/45/50/60
Page XL 6.4.14	Page XL 6.4.14	Page XL 6.4.15	Page XL 6.4.15	Page XL 6.4.15	Page XL 6.4.16	Page XL 6.4.16	Page XL 6.4.16	Page XL 6.4.17
<b>GRA..1858</b> Unit widths: 25/34	<b>GRA..1858</b> Unit widths: 25/34	<b>A..7955</b> Unit widths: 60	<b>ALT..7955</b> Unit widths: 60	<b>AN..79552</b> Unit widths: 60	<b>A..6655</b> Unit widths: 60	<b>ALT..6655</b> Unit widths: 60	<b>AN..66552</b> Unit widths: 60	<b>A..7355</b> Unit widths: 60
Page XL 6.4.17	Page XL 6.4.17	Page XL 6.4.18	Page XL 6.4.18					
<b>ALT..7355</b> Unit widths: 60	<b>AN..73552</b> Unit widths: 60	<b>A..6055</b> Unit widths: 60	<b>ALT..6055</b> Unit widths: 60					

# Recess overview Tall units 181.8 cm





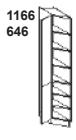
# Tall units 181.8 cm high

Carcase depth 55.5 cm (standard)

■ = Models also available in 34/45.5/61 cm carcass depth (Order no.: ... replace ... 55 ... with 34/45/61)  
 □ = Models also available in 45.5/61 cm carcass depth (order no.: replace ... 55 ... with 45/61)  
 ▲ = Types also available with 61 cm carcass depth (order no.: ... replace ... 55 ... with 61)

Order no.  
W H D

Hinge side: Carcass depth	Price groups								
	1	2	3	4	5	6	7	8	9
R/L ■	508	527	573	653	705	735	794	873	-
R/L ▲	1270	1290	1339	1397	1453	1481	1541	1695	-
▲	861	887	908	1037	1087	1133	1219	1341	-
▲	886	915	962	1090	1145	1202	1266	1393	-
▲	943	969	989	1117	1168	1214	1299	1429	-
▲	968	995	1042	1172	1226	1283	1345	1480	-
Width 30, 45 Not available for: ALUELEMENTS, ATLANTA-B, ATLANTA-S, BERGEN, CASTELLO, CHALET-B, CHALET-S, CHICAGO, FRAME, LUGANO, LUX-B, MIAMI, MODENA, MUNICH, NEVADA, NOBEL-B, NOBEL-S, ORLANDO-B, ORLANDO-S, OSLO 15, PADUA, SOFIE-B, SOFIE-S, TESSIN 15, TIM 15, VINO, VIVA, YORK-B, YORK-S									
▲	1028	1056	1074	1200	1251	1294	1383	1521	-
▲	1054	1102	1129	1256	1312	1366	1462	1608	-
▲	1110	1136	1154	1280	1332	1378	1463	1609	-
▲	1134	1184	1208	1338	1393	1449	1543	1697	-
Width 30, 45 Not available for: ALUELEMENTS, ATLANTA-B, ATLANTA-S, BERGEN, CASTELLO, CHALET-B, CHALET-S, CHICAGO, FRAME, LUGANO, LUX-B, MIAMI, MODENA, MUNICH, NEVADA, NOBEL-B, NOBEL-S, ORLANDO-B, ORLANDO-S, OSLO 15, PADUA, SOFIE-B, SOFIE-S, TESSIN 15, TIM 15, VINO, VIVA, YORK-B, YORK-S									
R/L ▲	1595	1609	1660	1761	1806	1835	1895	2085	-
R/L ▲	1673	1692	1751	1898	1957	1989	2056	2262	-
R/L ▲	1974	1988	2038	2131	2175	2205	2266	2493	-
R/L ▲	2052	2072	2128	2268	2327	2359	2426	2669	-
R/L ▲	1389	1403	1461	1619	1674	1708	1779	1957	-
R/L ▲	862	875	926	1061	1105	1135	1196	1316	-
R/L ▲	928	943	1002	1183	1239	1271	1343	1477	-
💡 The adjustable shelves will be delivered as a separate package.									
R/L ▲	915	926	978	1112	1155	1187	1248	1373	-
R/L ▲	978	993	1052	1232	1289	1322	1394	1533	-
💡 The adjustable shelves will be delivered as a separate package.									
R/L ■	328	341	392	477	528	557	618	680	-
R/L ■	328	341	392	477	528	557	618	680	-
R/L ■	328	341	392	477	528	557	618	680	-
R/L ■	328	341	392	526	569	601	660	726	-
R/L ■	367	381	440	621	677	710	782	860	-



**Crockery cupboard angled 37.2°**  
 1 door 116.6 cm  
 1 door 64.6 cm  
 1 fixed shelf  
 5 adjustable shelves  
 For adjacent fitting left or right

**GGG 25 18 55 02**



**Larder unit angled 37.2°**  
 1 door 116.6 cm connected to 1 door 64.6 cm  
 1 pull-out element  
 4 adjustable wooden shelves with chrome-plated square rail  
 For adjacent fitting left or right

**GVSTP25 18 55 02**



**Larder unit**  
 1 pull-out  
 1 door 116.6 cm connected to 1 door 64.6 cm  
 on telescopic rails, full height can be pulled out  
 With 5 adjustable wire baskets (chrome-plated)  
 Open top compartment 11.0 cm

**GV 30 18 55 02**

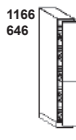
**GV 45 18 55 02**



**Larder unit**  
 1 pull-out 181.6 cm  
 on telescopic rails Full height can be pulled out  
 With 5 adjustable wire baskets (chrome-plated)  
 Open top compartment 11.0 cm

**GV 30 18 55 70**

**GV 45 18 55 70**



**Larder unit**  
 1 pull-out  
 1 door 116.6 cm connected to 1 door 64.6 cm  
 on telescopic rails Full height can be pulled out  
 with 5 adjustable wooden shelves with chrome-plated square rail  
 Open top compartment 11.0 cm

**GVP 30 18 55 02**

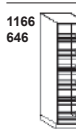
**GVP 45 18 55 02**



**Larder unit**  
 1 pull-out 181.6 cm  
 on telescopic rails, full height can be pulled out  
 with 5 adjustable wooden shelves with chrome-plated square rail  
 Open top compartment 11.0 cm

**GVP 30 18 55 70**

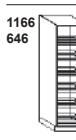
**GVP 45 18 55 70**



**Larder unit**  
 1 door 116.6 cm connected to 1 door 64.6 cm  
 1 swivel and pull-out element  
 6 adjustable and  
 6 removable wire baskets (chrome-plated)

**GV 50 18 55 02**

**GV 60 18 55 02**



**Larder unit**  
 1 door 116.6 cm connected to 1 door 64.6 cm  
 1 swivel and pull-out element  
 6 adjustable and 6 adjustable wooden shelves  
 with chrome-plated square rail

**GVP 50 18 55 02**

**GVP 60 18 55 02**



**Larder unit**  
 1 door 103.6 cm connected to 1 door 77.6 cm  
 1 pull-out element  
 4 adjustable wooden shelves with chrome-plated square rail  
 Open top compartment 29.1 cm

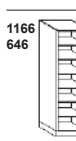
**GVPS 60 18 55**



**Larder unit**  
 1 door 116.6 cm connected to 1 door 64.6 cm  
 6 chrome-plated wire baskets  
 Adjustable in height  
 6 adjustable shelves reduced in depth

**GVT 50 18 55 02**

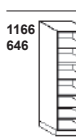
**GVT 60 18 55 02**



**Larder unit**  
 1 door 116.6 cm connected to 1 door 64.6 cm  
 6 wooden shelves with chrome-plated square rail  
 Adjustable in height  
 6 adjustable shelves reduced in depth

**GVPT 50 18 55 02**

**GVPT 60 18 55 02**



**Crockery cupboard**  
 1 door 116.6 cm  
 1 door 64.6 cm  
 1 fixed shelf  
 5 adjustable shelves

**GG 30 18 55 02**

**GG 40 18 55 02**

**GG 45 18 55 02**

**GG 50 18 55 02**

**GG 60 18 55 02**

78

# Tall units 181.8 cm high

Carcase depth 55.5 cm (standard)

- = Models also available in 34/45.5/61 cm carcass depth (Order no.: ... replace ... 55 ... with 34/45/61)
- = Models also available in 45.5/61 cm carcass depth (order no.: replace ... 55 ... with 45/61)
- ▲ = Types also available with 61 cm carcass depth (order no. ... replace ... 55 ... with 61)

Order no.  
W H D

Hinge side:	Carcass depth	Price groups									
		1	2	3	4	5	6	7	8	9	
R/L ■	■	GG 30 18 55 03	803	816	866	951	1004	1032	1094	1203	-
		GG 40 18 55 03	803	816	866	951	1004	1032	1094	1203	-
		GG 45 18 55 03	803	816	866	951	1004	1032	1094	1203	-
		GG 50 18 55 03	803	816	866	1002	1044	1075	1136	1250	-
		GG 60 18 55 03	843	858	916	1096	1151	1186	1257	1383	-
R/L ■	■	GG 30 18 55 01	328	341	392	477	528	557	618	680	-
		GG 40 18 55 01	328	341	392	477	528	557	618	680	-
		GG 45 18 55 01	328	341	392	477	528	557	618	680	-
		GG 50 18 55 01	328	341	392	526	569	601	660	726	-
		GG 60 18 55 01	367	381	440	621	677	710	782	860	-
R/L ■	■	GGA 30 18 55 01	969	981	1031	1100	1151	1182	1243	1367	-
		GGA 40 18 55 01	1010	1021	1072	1138	1190	1221	1282	1410	-
		GGA 45 18 55 01	1010	1021	1072	1138	1190	1221	1282	1410	-
		GGA 50 18 55 01	1024	1036	1087	1203	1249	1278	1340	1474	-
		GGA 60 18 55 01	1082	1097	1153	1320	1376	1409	1480	1628	-
<b>Width 30, 40, 45, 50 Not available for: MIAMI, VIVA</b> <b>Width 60</b>											
<b>Planning advice:</b> Doors with wide angle hinges may not be planned alongside units or panels if the protrusion to the front of the adjoining article is greater than 3 cm (hinge side). Doors with wide angle hinges protrude over the carcass side.											
R/L ■	■	GGA 30 18 55 03	1002	1013	1063	1131	1183	1212	1273	1400	-
		GGA 40 18 55 03	1049	1063	1113	1180	1230	1260	1323	1455	-
		GGA 45 18 55 03	1049	1063	1113	1180	1230	1260	1323	1455	-
		GGA 50 18 55 03	1070	1083	1133	1250	1292	1324	1385	1524	-
		GGA 60 18 55 03	1136	1154	1208	1374	1429	1462	1534	1687	-
<b>Width 30, 40, 45, 50 Not available for: MIAMI, VIVA</b> <b>Width 60</b>											
<b>Planning advice:</b> Doors with wide angle hinges may not be planned alongside units or panels if the protrusion to the front of the adjoining article is greater than 3 cm (hinge side). Doors with wide angle hinges protrude over the carcass side.											
R/L ■	■	GG 30 18 55 12	803	816	866	951	1004	1032	1094	1203	-
		GG 40 18 55 12	803	816	866	951	1004	1032	1094	1203	-
		GG 45 18 55 12	803	816	866	951	1004	1032	1094	1203	-
		GG 50 18 55 12	803	816	866	1002	1044	1075	1136	1250	-
		GG 60 18 55 12	843	858	916	1096	1151	1186	1257	1383	-
R/L ■	■	GG 30 18 55 05	328	341	392	477	528	557	618	680	-
		GG 40 18 55 05	328	341	392	477	528	557	618	680	-
		GG 45 18 55 05	328	341	392	477	528	557	618	680	-
		GG 50 18 55 05	328	341	392	526	569	601	660	726	-
		GG 60 18 55 05	367	381	440	621	677	710	782	860	-
<b>Width 30, 40, 45, 50, 60 Not available for: MIAMI, VIVA</b>											
R/L ■	■	GGA 30 18 55 06	969	981	1031	1100	1151	1182	1243	1367	-
		GGA 40 18 55 06	1010	1021	1072	1138	1190	1221	1282	1410	-
		GGA 45 18 55 06	1010	1021	1072	1138	1190	1221	1282	1410	-
		GGA 50 18 55 06	1024	1036	1087	1203	1249	1278	1340	1474	-
		GGA 60 18 55 06	1082	1097	1153	1320	1376	1409	1480	1628	-
<b>Width 30, 40, 45, 50, 60 Not available for: MIAMI, VIVA</b>											
<b>Planning advice:</b> Doors with wide angle hinges may not be planned alongside units or panels if the protrusion to the front of the adjoining article is greater than 3 cm (hinge side). Doors with wide angle hinges protrude over the carcass side.											
R/L ■	■	GG 30 18 55 70	410	422	474	557	608	639	700	770	-
		GG 40 18 55 70	410	422	474	557	608	639	700	770	-
		GG 45 18 55 70	410	422	474	557	608	639	700	770	-
		GG 50 18 55 70	410	422	474	606	650	682	742	816	-
		GG 60 18 55 70	446	464	523	702	759	791	862	948	-
<b>Width 30, 40, 45, 50, 60 Not available for: ALUELEMENTS, ATLANTA-B, ATLANTA-S, BERGEN, CASTELLO, CHALET-B, CHALET-S, CHICAGO, FRAME, LUGANO, LUX-B, MIAMI, MODENA, MUNICH, NEVADA, NOBEL-B, NOBEL-S, ORLANDO-B, ORLANDO-S, OSLO 15, PADUA, SOFIE-B, SOFIE-S, TESSIN 15, TIM 15, VINO, VIVA, YORK-B, YORK-S</b>											
<b>Each front has a tightening fitting</b> Ranges without fitting: SMARTGLAS, NOBEL, SOFIE, YORK, LUGANO, TALEA, RIVA, GARDA, ATLANTA, ORLANDO, CHICAGO without tightening fitting											



**Crockery cupboard**  
 1 door 116.6 cm  
 3 adjustable shelves  
 1 drawer 12.6 cm  
 2 pull-outs 25.6 cm



**Crockery cupboard**  
 1 door 103.6 cm  
 1 door 77.6 cm  
 1 fixed shelf  
 5 adjustable shelves



**Larder unit**  
 1 door 103.6 cm with wide angle hinges  
 2 internal pull-outs  
 1 fixed shelf  
 1 door 77.6 cm with wide angle hinges  
 2 internal pull-outs

**Planning advice:**  
 Take account of opening angle



**Larder unit**  
 1 door 103.6 cm with wide angle hinges  
 1 adjustable shelf  
 3 internal drawers  
 1 fixed shelf  
 1 door 77.6 cm with wide angle hinges  
 2 internal pull-outs

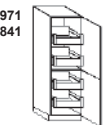
**Planning advice:**  
 Take account of opening angle



**Crockery cupboard**  
 1 door 103.6 cm  
 3 adjustable shelves  
 1 drawer 12.6 cm  
 1 pull-out 25.6 cm  
 1 pull-out 38.6 cm

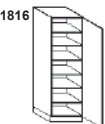


**Crockery cupboard**  
 1 door 97.1 cm  
 1 door 84.1 cm  
 1 fixed shelf  
 5 adjustable shelves



**Larder unit**  
 1 door 97.1 cm with wide angle hinges  
 2 internal pull-outs  
 1 fixed shelf  
 1 door 84.1 cm with wide angle hinges  
 2 internal pull-outs

**Planning advice:**  
 Take account of opening angle



**Crockery cupboard**  
 1 door 181.6 cm  
 1 fixed shelf  
 5 adjustable shelves

# Tall units 181.8 cm high

Carcase depth 55.5 cm (standard)

- = Models also available in 34/45.5/61 cm carcass depth (Order no.: ... replace ... 55 ... with 34/45/61)
- = Models also available in 45.5/61 cm carcass depth (order no.: replace ... 55 ... with 45/61)
- ▲ = Types also available with 61 cm carcass depth (order no.: ... replace ... 55 ... with 61)

Order no.  
W H D

Hinge side:	Carcass depth	Price groups														
		1	2	3	4	5	6	7	8	9						
1816	N		<b>Larder unit</b> 1 door 181.6 cm with wide angle hinges 2 internal pull-outs 1 fixed shelf 2 internal pull-outs		GGA 30 18 55 71	R/L	■	1049	1063	1112	1182	1232	1262	1324	1456	-
					GGA 40 18 55 71	R/L	■	1049	1063	1112	1182	1232	1262	1324	1456	-
					GGA 45 18 55 71	R/L	■	1090	1102	1152	1220	1272	1302	1363	1499	-
					GGA 50 18 55 71	R/L	■	1106	1116	1168	1284	1329	1359	1419	1561	-
					GGA 60 18 55 71	R/L	■	1163	1179	1235	1399	1456	1490	1560	1716	-
					<p> <b>Width 30, 40, 45, 50, 60 Not available for:</b> ALUELEMENTS, ATLANTA-B, ATLANTA-S, BERGEN, CASTELLO, CHALET-B, CHALET-S, CHICAGO, FRAME, LUGANO, LUX-B, MIAMI, MODENA, MUNICH, NEVADA, NOBEL-B, NOBEL-S, ORLANDO-B, ORLANDO-S, OSLO 15, PADUA, SOFIE-B, SOFIE-S, TESSIN 15, TIM 15, VINO, VIVA, YORK-B, YORK-S</p> <p> Each front has a tightening fitting Ranges without fitting: SMARTGLAS, NOBEL, SOFIE, YORK, LUGANO, TALEA, RIVA, GARDA, ATLANTA, ORLANDO, CHICAGO without tightening fitting Doors with wide angle hinges may not be planned alongside units or panels if the protrusion to the front of the adjoining article is greater than 3 cm (hinge side). Doors with wide angle hinges protrude over the carcass side.</p>											
1816	N		<b>Larder unit</b> 1 door 181.6 cm with wide angle hinges 3 internal drawers 1 fixed shelf 2 internal pull-outs		GGA 30 18 55 72	R/L	■	1082	1094	1143	1212	1264	1292	1353	1488	-
					GGA 40 18 55 72	R/L	■	1082	1094	1143	1212	1264	1292	1353	1488	-
					GGA 45 18 55 72	R/L	■	1131	1143	1195	1260	1312	1342	1403	1543	-
					GGA 50 18 55 72	R/L	■	1150	1165	1214	1331	1374	1405	1465	1612	-
					GGA 60 18 55 72	R/L	■	1218	1236	1290	1455	1508	1543	1615	1777	-
					<p> <b>Width 30, 40, 45, 50, 60 Not available for:</b> ALUELEMENTS, ATLANTA-B, ATLANTA-S, BERGEN, CASTELLO, CHALET-B, CHALET-S, CHICAGO, FRAME, LUGANO, LUX-B, MIAMI, MODENA, MUNICH, NEVADA, NOBEL-B, NOBEL-S, ORLANDO-B, ORLANDO-S, OSLO 15, PADUA, SOFIE-B, SOFIE-S, TESSIN 15, TIM 15, VINO, VIVA, YORK-B, YORK-S</p> <p> Each front has a tightening fitting Ranges without fitting: SMARTGLAS, NOBEL, SOFIE, YORK, LUGANO, TALEA, RIVA, GARDA, ATLANTA, ORLANDO, CHICAGO without tightening fitting Doors with wide angle hinges may not be planned alongside units or panels if the protrusion to the front of the adjoining article is greater than 3 cm (hinge side). Doors with wide angle hinges protrude over the carcass side.</p>											
1166 646			<b>Broom cupboard</b> 1 door 116.6 cm connected to 1 door 64.6 cm 1 fixed shelf 1 storage basket 1 hook rail		GB 30 18 55 02	R/L	□	328	341	392	477	528	557	618	680	-
					GB 40 18 55 02	R/L	□	328	341	392	477	528	557	618	680	-
					GB 45 18 55 02	R/L	□	328	341	392	477	528	557	618	680	-
					GB 50 18 55 02	R/L	□	328	341	392	526	569	601	660	726	-
					GB 60 18 55 02	R/L	□	367	381	440	621	677	710	782	860	-
1036 776			<b>Broom cupboard</b> 1 door 103.6 cm connected to 1 door 77.6 cm 1 fixed shelf 1 storage basket 1 hook rail	78	GB 30 18 55 01	R/L	□	328	341	392	477	528	557	618	680	-
					GB 40 18 55 01	R/L	□	328	341	392	477	528	557	618	680	-
					GB 45 18 55 01	R/L	□	328	341	392	477	528	557	618	680	-
					GB 50 18 55 01	R/L	□	328	341	392	526	569	601	660	726	-
					GB 60 18 55 01	R/L	□	367	381	440	621	677	710	782	860	-
1816	N		<b>Broom cupboard</b> 1 door 181.6 cm 1 fixed shelf 1 hook rail 1 storage basket		GB 30 18 55 70	R/L	□	410	422	474	557	608	639	700	770	-
					GB 40 18 55 70	R/L	□	410	422	474	557	608	639	700	770	-
					GB 45 18 55 70	R/L	□	410	422	474	557	608	639	700	770	-
					GB 50 18 55 70	R/L	□	410	422	474	606	650	682	742	816	-
					GB 60 18 55 70	R/L	□	446	464	523	702	759	791	862	948	-
					<p> <b>Width 30, 40, 45, 60 Not available for:</b> ALUELEMENTS, ATLANTA-B, ATLANTA-S, BERGEN, CASTELLO, CHALET-B, CHALET-S, CHICAGO, FRAME, LUGANO, LUX-B, MIAMI, MODENA, MUNICH, NEVADA, NOBEL-B, NOBEL-S, ORLANDO-B, ORLANDO-S, OSLO 15, PADUA, SOFIE-B, SOFIE-S, TESSIN 15, TIM 15, VINO, VIVA, YORK-B, YORK-S</p> <p> Each front has a tightening fitting Ranges without fitting: SMARTGLAS, NOBEL, SOFIE, YORK, LUGANO, TALEA, RIVA, GARDA, ATLANTA, ORLANDO, CHICAGO without tightening fitting</p>											
1166 646			<b>Broom cupboard</b> 1 door 116.6 cm connected to 1 door 64.6 cm 1 fixed shelf 1 hook rail with 5 hooks, anthracite Modular interior partitioning system, consisting of: 1 set of attachment rails, anthracite 1 large 3-side tray with rail, anthracite 1 carrier box for cleaning materials with carrier rails, anthracite 1 hook rail with 5 hooks, anthracite		GB 40 18 55 12	R/L	▲	514	528	579	664	714	743	805	886	-
					GB 45 18 55 12	R/L	▲	514	528	579	664	714	743	805	886	-
					GB 50 18 55 12	R/L	▲	514	528	579	712	756	788	847	932	-
					GB 60 18 55 12	R/L	▲	553	568	626	808	864	897	969	1066	-
										<p> <b>Optional accessories</b> HW HS Holder for vacuum cleaner hose or PET storage pocket (for screwing on), anthracite HW UTB Utensils box, e.g. for storing towels, cleaning cloths, etc. (for screwing on), anthracite</p>						
1036 776			<b>Broom cupboard</b> 1 door 103.6 cm connected to 1 door 77.6 cm 1 fixed shelf 1 hook rail with 5 hooks, anthracite Modular interior partitioning system, consisting of: 1 set of attachment rails, anthracite 1 large 3-side tray with rail, anthracite 1 carrier box for cleaning materials with carrier rails, anthracite 1 hook rail with 5 hooks, anthracite	78	GB 40 18 55 11	R/L	▲	514	528	579	664	714	743	805	886	-
					GB 45 18 55 11	R/L	▲	514	528	579	664	714	743	805	886	-
					GB 50 18 55 11	R/L	▲	514	528	579	712	756	788	847	932	-
					GB 60 18 55 11	R/L	▲	553	568	626	808	864	897	969	1066	-
										<p> <b>Optional accessories</b> HW HS Holder for vacuum cleaner hose or PET storage pocket (for screwing on), anthracite HW UTB Utensils box, e.g. for storing towels, cleaning cloths, etc. (for screwing on), anthracite</p>						

## Tall units 181.8 cm high

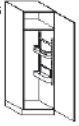
Carcase depth 55.5 cm (standard)

- = Models also available in 34/45.5/61 cm carcass depth (Order no.: ... replace ... 55 ... with 34/45/61)
- = Models also available in 45.5/61 cm carcass depth (order no.: replace ... 55 ... with 45/61)
- ▲ = Types also available with 61 cm carcass depth (order no. ... replace ... 55 ... with 61)

Order no.  
W H D

		Price groups								
Hinge side:	Carcass depth	1	2	3	4	5	6	7	8	9
		R/L ▲	597	608	661	743	795	826	886	975
R/L ▲	597	608	661	743	795	826	886	975	-	
R/L ▲	597	608	661	793	836	869	929	1022	-	
R/L ▲	633	651	744	888	946	977	1048	1153	-	

1816



### Broom cupboard

- 1 door 181.6 cm
- 1 fixed shelf
- 1 hook rail with 5 hooks, anthracite
- Modular interior partitioning system, consisting of:
  - 1 set of attachment rails, anthracite
  - 1 large 3-side tray with rail, anthracite
  - 1 carrier box for cleaning materials with carrier rails, anthracite
  - 1 hook rail with 5 hooks, anthracite



<b>GB</b>	<b>40</b>	<b>18</b>	<b>55</b>	<b>71</b>	R/L ▲	597	608	661	743	795	826	886	975	-
<b>GB</b>	<b>45</b>	<b>18</b>	<b>55</b>	<b>71</b>	R/L ▲	597	608	661	743	795	826	886	975	-
<b>GB</b>	<b>50</b>	<b>18</b>	<b>55</b>	<b>71</b>	R/L ▲	597	608	661	793	836	869	929	1022	-
<b>GB</b>	<b>60</b>	<b>18</b>	<b>55</b>	<b>71</b>	R/L ▲	633	651	744	888	946	977	1048	1153	-

**Width 40, 45, 60 Not available for:** ALUELEMENTS, ATLANTA-B, ATLANTA-S, BERGEN, CAS-TELLO, CHALET-B, CHALET-S, CHICAGO, FRAME, LUGANO, LUX-B, MIAMI, MODENA, MUNICH, NEVADA, NOBEL-B, NOBEL-S, ORLANDO-B, ORLANDO-S, OSLO 15, PADUA, SOFIE-B, SOFIE-S, TESSIN 15, TIM 15, VINO, VIVA, YORK-B, YORK-S

**Optional accessories**  
**HW HS** Holder for vacuum cleaner hose or **PET** storage pocket (for screwing on), anthracite  
**HW UTB** Utensils box, e.g. for storing towels, cleaning cloths, etc. (for screwing on), anthracite  
 Each front has a tightening fitting  
 Ranges without fitting: SMARTGLAS, NOBEL, SOFIE, YORK, LUGANO, TALEA, RIVA, GARDA, ATLANTA, ORLANDO, CHICAGO without tightening fitting

## Tall units 181.8 cm high with glass fronts

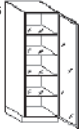
Carcass depth 55.5 cm (standard)

- = Models also available in 34/45.5/61 cm carcass depth (Order no.: ... replace ... 55 ... with 34/45/61)

Order no.  
W H D

		Glass groups					
Hinge side:	Carcass depth	G1	G2	G2S	G5S	G6	
		R/L ■	-	-	1029	1204	1413
R/L ■	-	-	1052	1230	1436		
R/L ■	-	-	1077	1259	1461		

1816



### Crockery cupboard with glass front

- neutral-
- 1 glass door 181.6 cm
- 4 adjustable glass shelves

34.0	45.5	55.5	61.0
------	------	------	------

<b>GGGD</b>	<b>45</b>	<b>18</b>	<b>55</b>	<b>70</b>	R/L ■	-	-	1029	1204	1413
<b>GGGD</b>	<b>50</b>	<b>18</b>	<b>55</b>	<b>70</b>	R/L ■	-	-	1052	1230	1436
<b>GGGD</b>	<b>60</b>	<b>18</b>	<b>55</b>	<b>70</b>	R/L ■	-	-	1077	1259	1461

G 1		G 2		G 2S	
Config. of glass front elements		G1 AKTIV glass frame		G2 Design front	
G 5		G 5S		G 6	
G2S aluminium, framed glass door		G5S aluminium, door with mullion		G6 NEW SALON	

## Additional equipment

Order no.  
W H D

		Decor groups								
Hinge side:	Carcass depth	M10	M20	M30	M40	M50	M60	M70	M80	M90
		R/L ■	-	-	-	-	1646	-	1646	1646

**Surcharge for tall cabinets with glass fronts inside and exterior in the same design**  
 available in decor groups:  
 S/B/H/MP/F/Z





IDF-G

M 10		M 20		M 30		M 40		M 50	
K M10 laminate								B M50 Velvet lacquer S M50 microstructure lacquer	

M 60		M 70		M 80		M 90	
		F M70 veneer / oak / walnut Z M70 Veneer / Bavaria		H M80 high gloss-Lacquer MP M80 laqué mat Premium			

# Tall units 181.8 cm high with roller shutter

The useable inside depth (bare dimension) for the following carcass depths is  
 36.1 cm – bare dimension 26.5 cm / 47.7 cm – bare dimension 38.1 cm  
 57.7 cm – bare dimension 48.1 cm / 63.2 cm – bare dimension 53.6 cm  
 ▲ = Types also available with 63.2 cm carcass depth (order no. ... replace ... 58 ... with 63)

		Order no. W H D	Hinge side: Carcass depth	Decor groups								
				M10	M20	M30	M40	M50	M60	M70	M80	M90
	<b>Tall unit with roller shutter 181,8 cm high</b> Roller shutter stainless steel decor 5 adjustable shelves 1 structural shelf 3 sockets	<b>GJG 60 18 58 77</b>	▲	1638	-	-	-	3763	-	4441	-	-
	optional accessory: only TAB-A**45 can be used as a pull-out shelf, and only 577 mm deep No visible sides possible in other decor groups											
	<b>as above, but Tall unit with roller shutter 181,8 cm high 47,7 cm deep</b>	<b>GJG 60 18 48 77</b>		1597	-	-	-	3482	-	4069	-	-
No visible sides possible in other decor groups												
	<b>Tall unit with roller shutter 181,8 cm high</b> Roller shutters black laminate 5 adjustable shelves 1 structural shelf 3 sockets	<b>GJG 60 18 58 78</b>	▲	1751	-	-	-	3875	-	4555	-	-
	optional accessory: only TAB-A**45 can be used as a pull-out shelf, and only 577 mm deep No visible sides possible in other decor groups											
	<b>as above, but Tall unit with roller shutter 181,8 cm high 47,7 cm deep</b>	<b>GJG 60 18 48 78</b>		1711	-	-	-	3596	-	4183	-	-
No visible sides possible in other decor groups												
	<b>Tall unit SMARTGLAS roller shutters 181,8 cm high 57,7 cm deep</b> 5 adjustable shelves 1 structural shelf 3 sockets	<b>GJSGG 60 18 58</b>	▲	3335	-	-	-	5459	-	6138	-	-
	Panel, guide profile and handle in the same colour as the roller shutter optional accessory: only TAB-A**45 can be used as a pull-out shelf, and only 577 mm deep No visible sides possible in other decor groups											
	<b>as above, but Tall unit SMARTGLAS roller shutters 181,8 cm high 47,7 cm deep</b>	<b>GJSGG 60 18 48</b>		3294	-	-	-	5179	-	5766	-	-
No visible sides possible in other decor groups												
M 10	M 20	M 30	M 40	M 50								
K M10 laminate				B M50 Velvet Lacquer S Microstructure lacquer								
M 60	M 70	M 80	M 90									
	F M70 veneer / oak / walnut Z M70 Veneer / Bavaria											
	<b>Pull-out shelf with guide rails</b> With locking function, full pull-out „push to open“ , shelf from decor group K For carcass width 45 cm, 50 cm, 60 cm For carcass width 80 cm, 90 cm for carcass depths 45.5 cm and 55.5 cm  Load-bearing capacity depth 55.5 cm: 35 kg Load-bearing capacity depth 45.5 cm: 35 kg Load-bearing capacity depth 55.5 cm: 35 kg Load-bearing capacity depth 45.5 cm: 35 kg Load-bearing capacity depth 55.5 cm: 35 kg Load-bearing capacity depth 45.5 cm: 35 kg Load-bearing capacity depth 55.5 cm: 30 kg Load-bearing capacity depth 45.5 cm: 30 kg Load-bearing capacity depth 55.5 cm: 30 kg Load-bearing capacity depth 45.5 cm: 30 kg	<b>Important:</b> When installing in units with hinged doors always take wide angle hinges <b>SA-90155E3</b> into consideration.										
	<b>TAB-AZ45 55</b>		220	-	-	-	-	-	-	-	-	-
	<b>TAB-AZ45 45</b>		220	-	-	-	-	-	-	-	-	-
	<b>TAB-AZ50 55</b>		225	-	-	-	-	-	-	-	-	-
	<b>TAB-AZ50 45</b>		225	-	-	-	-	-	-	-	-	-
	<b>TAB-AZ60 55</b>		234	-	-	-	-	-	-	-	-	-
	<b>TAB-AZ60 45</b>		234	-	-	-	-	-	-	-	-	-
	<b>TAB-AZ80 55</b>		282	-	-	-	-	-	-	-	-	-
	<b>TAB-AZ80 45</b>		282	-	-	-	-	-	-	-	-	-
	<b>TAB-AZ90 55</b>		298	-	-	-	-	-	-	-	-	-
	<b>TAB-AZ90 45</b>		298	-	-	-	-	-	-	-	-	-



# Appliance unit 181.8 cm high for microwave / oven

Carcase depth 55.5 cm (standard)

▲ = Types also available with 61 cm carcass depth (order no. ... replace ... 55 ... with 61)

				Order no.				Price groups													
				W	H	D	Hinge side:	Carcass depth	1	2	3	4	5	6	7	8	9				
516 776		<b>Appliance unit</b> 1 door 51.6 cm 1 adjustable shelf 1 panel 1 appliance aperture 36.2 - 50 cm 1 door 77.6 cm 2 adjustable shelves	36,2-50,0	GO	60	18	55	10	1	R/L	▲	407	421	481	570	608	639	702	772	-	
		<b>Appliance unit with compensation door above appliance aperture</b>		GO	60	18	55	10	1A	R/L	▲	407	421	481	570	608	639	702	772	-	
386 906		<b>Appliance unit</b> 1 door 38.6 cm 1 panel 1 appliance aperture 37.3 - 50 cm 1 door 90.6 cm 3 adjustable shelves	37,3-50,0	GO	60	18	55	10		R/L	▲	407	421	481	570	608	639	702	772	-	
		<b>Appliance unit with compensation door above appliance aperture</b>		GO	60	18	55	10	A	R/L	▲	407	421	481	570	608	639	702	772	-	
386 126 776		<b>Appliance unit</b> 1 door 38.6 cm 1 panel 1 appliance aperture 37.3 - 50 cm 1 drawer 12.6 cm 1 door 77.6 cm 2 adjustable shelves	37,3-50,0	GO	60	18	55	10	5	R/L	▲	549	565	624	713	752	782	847	932	-	
		<b>Appliance unit with compensation door above appliance aperture</b>		GO	60	18	55	10	5A	R/L	▲	549	565	624	713	752	782	847	932	-	
386 451		<b>Appliance unit</b> 1 appliance aperture 37.3 - 50 cm 1 pull-out 38.6 cm 1 pull-out 45.1 cm 1 adjustable shelf	37,3-50,0	GO	60	18	55	10	X9A	R/L	▲	739	757	815	895	936	966	1028	1131	-	
		<b>Appliance unit with compensation door above appliance aperture</b>																			
516 126 256 386		<b>Appliance unit</b> 2 doors 51.6 cm 1 adjustable shelf 1 panel 1 appliance aperture 46.0 - 48.0 cm 1 drawer 12.6 cm 1 pull-out 25.6 cm 1 pull-out 38.6 cm	46,0-48,0	GO	90	18	55	10	12		▲	1321	1360	1553	1803	1883	1986	2202	2422	-	
		<b>Appliance unit with compensation door above appliance aperture</b>		GO	90	18	55	10	12A		▲	1321	1360	1553	1803	1883	1986	2202	2422	-	
386 776		<b>Appliance unit</b> 1 door 38.6 cm 1 panel 1 appliance aperture 58.0 - 59.5 cm 1 door 77.6 cm 2 adjustable shelves	58,0-59,5	GO	60	18	55	20	X	R/L	▲	407	421	481	570	608	639	702	772	-	
		<b>Appliance unit with compensation door above appliance aperture</b>		GO	60	18	55	20	XA	R/L	▲	407	421	481	570	608	639	702	772	-	
386 126 256 386		<b>Appliance unit</b> 1 door 38.6 cm 1 panel 1 appliance aperture 58.0 - 59.5 cm 1 drawer 12.6 cm 1 pull-out 25.6 cm 1 pull-out 38.6 cm	58,0-59,5	GO	60	18	55	20	X2	R/L	▲	881	898	956	1045	1084	1113	1178	1296	-	
		<b>Appliance unit with compensation door above appliance aperture</b>		GO	60	18	55	20	X2A	R/L	▲	881	898	956	1045	1084	1113	1178	1296	-	
321 126 256 451		<b>Appliance unit</b> 1 flap door 32.1 cm 1 panel 1 appliance aperture 58.0 - 59.5 cm 1 drawer 12.6 cm 1 pull-out 25.6 cm 1 pull-out 45.1 cm	58,0-59,5	GO	60	18	55	20	X8	R/L	▲	881	898	956	1045	1084	1113	1178	1296	-	
		<b>Appliance unit with compensation door above appliance aperture</b>		GO	60	18	55	20	X8A	R/L	▲	881	898	956	1045	1084	1113	1178	1296	-	
386 451		<b>Appliance unit</b> 1 appliance aperture 58.0 - 59.5 cm 1 pull-out 38.6 cm 1 pull-out 45.1 cm	58,0-59,5	GO	60	18	55	20	X9A	R/L	▲	739	757	815	895	936	966	1028	1131	-	
		<b>Appliance unit with compensation door above appliance aperture</b>																			

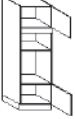

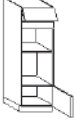
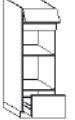


## Appliance unit 181.8 cm high for microwave / oven Double aperture

Carcase depth 55.5 cm (standard)

		Price groups								
		1	2	3	4	5	6	7	8	9
	Order no. W H D									
	Hinge side: ▲ Carcase depth									



▲ = Types also available with 61 cm carcase depth (order no. ... replace ... 55 ... with 61)

386 386		<b>Appliance unit</b> 1 door 38.6 cm 1 panel 1 appliance aperture 30.8 - 40.9 cm 1 appliance aperture 58.0 - 59.5 cm 1 door 38.6 cm	30.8-40.9	GO	60	18	55	27	X	R/L	▲	407	421	481	570	608	639	702	772	-
			58.0-59.5																	
		 <b>Appliance unit with compensation door above appliance aperture</b>		GO	60	18	55	27	XA	R/L	▲	407	421	481	570	608	639	702	772	-
256 386		<b>Appliance unit</b> 1 flap door 25.6 cm 1 panel 1 appliance aperture 41 - 50 cm 1 appliance aperture 58.0 - 59.5 cm 1 door 38.6 cm	41.0-50.0	GO	60	18	55	28	X	R/L	▲	407	421	481	570	608	639	702	772	-
			58.0-59.5																	
256 386		<b>Appliance unit</b> 1 flap door 25.6 cm 1 panel 1 appliance aperture 41 - 50 cm 1 appliance aperture 58.0 - 59.5 cm 1 pull-out 38.6 cm	41.0-50.0	GO	60	18	55	28	X2		▲	554	570	629	719	759	787	851	936	-
			58.0-59.5																	

## Appliance unit 181.8 cm high for microwave / oven Lifting door / aperture

Carcase depth 55.5 cm (standard)

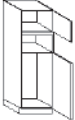

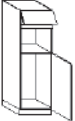

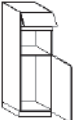

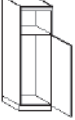

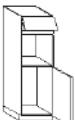

▲ = Types also available with 61 cm carcase depth (order no. ... replace ... 55 ... with 61)

256 516 126 256		<b>Appliance unit</b> 1 flap door 25.6 cm 1 lifting door with front 51.6 cm 1 panel 1 appliance aperture 58.0 - 59.5 cm 1 drawer 12.6 cm 1 pull-out 25.6 cm	58.0-59.5	GO	60	18	55	36	X6	R/L	▲	809	823	855	982	1035	1055	1136	1250	-
		 <b>Appliance unit with compensation door above appliance aperture</b>		GO	60	18	55	36	X6A	R/L	▲	809	823	855	982	1035	1055	1136	1250	-

## Appliance unit 181.8 cm high for refrigerator/freezer

Carcase depth 55.5 cm (standard)

▲ = Types also available with 61 cm carcase depth (order no. ... replace ... 55 ... with 61)

386 906		<b>Appliance unit</b> 1 door 38.6 cm 1 panel 1 appliance aperture 37.3 - 50 cm 1 integrated appliance aperture 88 cm 1 door 90.6 cm	37.3-50.0	GOI	60	18	55	11	X	R/L	▲	407	421	481	570	608	639	702	772	-
			88,0																	
		 <b>Appliance unit with compensation door above appliance aperture</b>		GOI	60	18	55	11	XA	R/L	▲	407	421	481	570	608	639	702	772	-
1063		<b>Appliance unit</b> 1 flap door 25.6 cm 1 panel 1 appliance aperture 36.0 - 45 cm 1 integrated appliance aperture 102.5 cm 1 door 106.3 cm	36.0-45.0	GOI	60	18	55	12	X4	R/L	▲	407	421	481	570	608	639	702	772	-
			102,5																	
		 <b>Appliance unit with compensation door above appliance aperture</b>		GOI	60	18	55	12	X4A	R/L	▲	407	421	481	570	608	639	702	772	-
256 1036		<b>Appliance unit</b> 1 flap door 25.6 cm 1 panel 1 appliance aperture 37.3 - 45 cm 1 integrated appliance aperture 102.3 cm 1 door 103.6 cm	37.3-45.0	GOI	60	18	55	12	X1	R/L	▲	478	493	553	641	679	708	772	849	-
			102,3																	
		 <b>Appliance unit with compensation door above appliance aperture</b>		GOI	60	18	55	12	X1A	R/L	▲	478	493	553	641	679	708	772	849	-
1296		<b>Appliance unit</b> 1 panel 1 appliance aperture 37.3 - 50 cm 1 integrated appliance aperture 122.5 cm 1 door 129.6 cm	37.3-50.0	GOI	60	18	55	13	X	R/L	▲	407	421	481	570	608	639	702	772	-
			122,5																	
		 <b>Appliance unit with compensation door above appliance aperture</b>		GOI	60	18	55	13	XA	R/L	▲	407	421	481	570	608	639	702	772	-
256 906		<b>Appliance unit</b> 1 flap door 25.6 cm 1 panel 1 appliance aperture 58.0 - 59.5 cm 1 integrated appliance aperture 88 cm 1 door 90.6 cm	58.0-59.5	GOI	60	18	55	21	X	R/L	▲	407	421	481	570	608	639	702	772	-
			88,0																	
		 <b>Appliance unit with compensation door above appliance aperture</b>		GOI	60	18	55	21	XA	R/L	▲	407	421	481	570	608	639	702	772	-



Models not available with compensation door: MIAMI, VIVA



# Appliance unit 181.8 cm high for refrigerator/freezer

Carcase depth 55.5 cm (standard)

▲ = Types also available with 61 cm carcass depth (order no. ... replace ... 55 ... with 61)

		Order no.			Hinge side:	Carcass depth	Price groups								
		W	H	D			1	2	3	4	5	6	7	8	9
1166 	<b>Appliance unit with integrated ventilation</b> 1 panel 1 appliance aperture 58.0 - 59.5 cm 1 integrated appliance aperture 103 cm 1 door 116.6 cm	58,0-59,5 103,0	<b>GOIB 60 18 55 22 X</b>	R/L ▲	▲	407	421	481	570	608	639	702	772	-	
	Important: Observe the appliance manufacturers' permitted front weights for fixed door assembly. See overview of models for front weights.														
516 386 906 	<b>Appliance unit</b> 1 door 51.6 cm 1 lifting door with front 38.6 cm 1 integrated appliance aperture 88 cm 1 door 90.6 cm 1 adjustable shelf	88,0	<b>GI 60 18 55 35 X</b>	R/L ▲	▲	535	555	612	701	737	770	830	913	-	
	Important: Observe the appliance manufacturers' permitted front weights for fixed door assembly. See overview of models for front weights.														
256 906 646 	<b>Appliance unit</b> 1 flap door 25.6 cm 1 integrated appliance aperture 88 cm 1 door 90.6 cm 1 door 64.6 cm 2 adjustable shelves	88,0	<b>GI 60 18 55 30 X</b>	R/L ▲	▲	423	444	519	660	750	796	873	960	-	
	Important: Observe the appliance manufacturers' permitted front weights for fixed door assembly. See overview of models for front weights.														
	<b>Appliance unit with integrated ventilation</b>		<b>GIB 60 18 55 30 X</b>	R/L ▲	▲	441	462	537	677	769	814	891	980	-	
256 906 126 256 256 	<b>Appliance unit</b> 1 flap door 25.6 cm 1 integrated appliance aperture 88 cm 1 door 90.6 cm 1 drawer 12.6 cm 2 pull-outs 25.6 cm	88,0	<b>GI 60 18 55 30 X2</b>	R/L ▲	▲	900	921	993	1136	1226	1272	1349	1484	-	
	Important: Observe the appliance manufacturers' permitted front weights for fixed door assembly. See overview of models for front weights.														
	<b>Appliance unit with integrated ventilation</b>		<b>GIB 60 18 55 30 X2</b>	R/L ▲	▲	917	938	1010	1153	1243	1289	1366	1503	-	
256 1036 516 	<b>Appliance unit</b> 1 flap door 25.6 cm 1 integrated appliance aperture 103 cm 1 door 103.6 cm 1 door 51.6 cm 1 adjustable shelf	103,0	<b>GI 60 18 55 40 X</b>	R/L ▲	▲	423	444	519	660	750	796	873	960	-	
	Important: Observe the appliance manufacturers' permitted front weights for fixed door assembly. See overview of models for front weights.														
	<b>Appliance unit with integrated ventilation</b>		<b>GIB 60 18 55 40 X</b>	R/L ▲	▲	440	461	536	676	767	813	889	978	-	
256 1036 126 386 	<b>Appliance unit</b> 1 flap door 25.6 cm 1 integrated appliance aperture 103 cm 1 door 103.6 cm 1 drawer 12.6 cm 1 pull-out 38.6 cm	103,0	<b>GI 60 18 55 40 X2</b>	R/L ▲	▲	718	739	813	955	1045	1090	1170	1287	-	
	Important: Observe the appliance manufacturers' permitted front weights for fixed door assembly. See overview of models for front weights.														
	<b>Appliance unit with integrated ventilation</b>		<b>GIB 60 18 55 40 X2</b>	R/L ▲	▲	735	756	830	972	1062	1107	1186	1305	-	
256 1296 256 	<b>Appliance unit</b> 1 flap door 25.6 cm 1 integrated appliance aperture 122.5 cm 1 door 129.6 cm 1 pull-out 25.6 cm	122,5	<b>GI 60 18 55 50 X</b>	R/L ▲	▲	506	531	604	802	862	909	996	1096	-	
	Important: Observe the appliance manufacturers' permitted front weights for fixed door assembly. See overview of models for front weights.														
	<b>Appliance unit with integrated ventilation</b>		<b>GIB 60 18 55 50 X</b>	R/L ▲	▲	523	548	621	818	879	926	1013	1114	-	
256 386 906 256 	<b>Appliance unit</b> 1 flap door 25.6 cm 1 integrated appliance aperture 122.5 cm 1 door 38.6 cm 1 door 90.6 cm 1 pull-out 25.6 cm	122,5	<b>GI 60 18 55 55 01</b>	R/L ▲	▲	532	555	630	825	887	932	1020	1122	-	
	Important: Observe the appliance manufacturers' permitted front weights for fixed door assembly. See overview of models for front weights.														
256 711 841 	<b>Appliance unit</b> 1 flap door 25.6 cm 1 integrated appliance aperture 140 cm 1 door 71.1 cm attached to 1 door 84.1 cm	140,0 84,5	<b>GI 60 18 55 62 X8</b>	R/L ▲	▲	423	444	519	660	750	796	873	960	-	
	Important: Observe the appliance manufacturers' permitted front weights for fixed door assembly. See overview of models for front weights.														
256 776 776 	<b>Appliance unit</b> 1 flap door 25.6 cm 1 integrated appliance aperture 140 cm 1 door 77.6 cm attached to 1 door 77.6 cm	140,0 78	<b>GI 60 18 55 62 01</b>	R/L ▲	▲	423	444	519	660	750	796	873	960	-	
	Important: Observe the appliance manufacturers' permitted front weights for fixed door assembly. See overview of models for front weights.														
	<b>Appliance unit with integrated ventilation</b>		<b>GIB 60 18 55 62 01</b>	R/L ▲	▲	440	462	536	677	769	813	893	982	-	

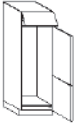

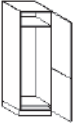

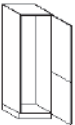

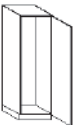




# Appliance unit 181.8 cm high for refrigerator/freezer

Carcase depth 55.5 cm (standard)

		Price groups								
Hinge side:	Carcase depth	1	2	3	4	5	6	7	8	9
		R/L ▲	423	444	519	660	750	796	873	960





▲ = Types also available with 61 cm carcase depth (order no. ... replace ... 55 ... with 61)  
 Order no. W H D

256 906 646		<b>Appliance unit</b> 1 flap door 25.6 cm 1 integrated appliance aperture 144.6 cm 1 door 90.6 cm 1 door 64.6 cm	144,6	GI 60 18 55 68 X1	R/L ▲	423	444	519	660	750	796	873	960	-	 Important: Observe the appliance manufacturers' permitted front weights for fixed door assembly. See overview of models for front weights.
1036 776		<b>Appliance unit</b> 1 integrated appliance aperture 144.6 cm 1 door 103.6 cm 1 door 77.6 cm	144,6 78	GI 60 18 55 68 X2	R/L ▲	423	444	519	660	750	796	873	960	-	 Important: Observe the appliance manufacturers' permitted front weights for fixed door assembly. See overview of models for front weights.
1036 776		<b>Appliance unit</b> 1 integrated appliance aperture 177.8 cm 1 door 103.6 cm connected to 1 door 77.6 cm	177,8 78	GI 60 18 55 87 X5	R/L ▲	471	491	565	707	797	843	921	1013	-	 Important: Observe the appliance manufacturers' permitted front weights for fixed door assembly. See overview of models for front weights.
1816		<b>Appliance unit</b> 1 door 181.6 cm 1 integrated appliance aperture 177.8 cm	177,8	GI 60 18 55 87 X1	R/L ▲	501	524	598	738	832	878	954	1049	-	 <b>Not available for:</b> ALUELEMENTS, ATLANTA-B, ATLANTA-S, BERGEN, CASTELLO, CHALET-B, CHALET-S, CHICAGO, FRAME, LUGANO, LUX-B, MIAMI, MODENA, MUNICH, NEVADA, NOBEL-B, NOBEL-S, ORLANDO-B, ORLANDO-S, OSLO 15, PADUA, SOFIE-B, SOFIE-S, TESSIN 15, TIM 15, VINO, VIVA, YORK-B, YORK-S   The tightening fitting will be replaced with carrying-door technology on appliance units. Important: Observe the appliance manufacturers' permitted front weights for fixed door assembly. See overview of models for front weights.

# Appliance unit 181.8 cm high for refrigerator/freezer Double aperture

Carcase depth 55.5 cm (standard)


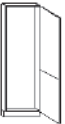
▲ = Types also available with 61 cm carcase depth (order no. ... replace ... 55 ... with 61)

906 906		<b>Appliance unit</b> 1 integrated appliance aperture 88 cm 1 door 90.6 cm 1 integrated appliance aperture 72 cm 1 door 90.6 cm	88,0 72,0	GI 60 18 55 32 X	R/L ▲	423	444	519	660	750	796	873	960	-	 Important: Observe the appliance manufacturers' permitted front weights for fixed door assembly. See overview of models for front weights.
906 906		<b>Appliance unit</b> 1 integrated appliance aperture 88 cm 1 door 90.6 cm 1 integrated appliance aperture 88 cm 1 door 90.6 cm	88,0 88,0	GI 60 18 55 33 X	R/L ▲	423	444	519	660	750	796	873	960	-	 Important: Observe the appliance manufacturers' permitted front weights for fixed door assembly. See overview of models for front weights.










Models not available with compensation door: MIAMI, VIVA

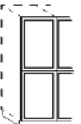

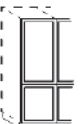

## spacefitter frame 181.8 cm high

		Order no.		Hinge side:	Carcase depth	Price groups								
		W	H			D	1	2	3	4	5	6	7	8
 <p><b>1166 646</b></p> <p><b>Tall unit spacefitter frame</b> 1 door 116.6 cm connected to 1 door 64.6 cm Carcase depth 10 cm For recess cladding</p>		<b>GPR 30 18 10 02</b>	R/L	230	239	275	359	370	391	435	479	-		
		<b>GPR 45 18 10 02</b>	R/L	230	239	275	359	370	391	435	479	-		
		<b>GPR 50 18 10 02</b>	R/L	230	239	275	384	400	422	465	512	-		
		<b>GPR 60 18 10 02</b>	R/L	258	268	308	448	477	498	549	604	-		
 <p><b>1036 776</b></p> <p><b>Tall unit spacefitter frame</b> 1 door 103.6 cm connected to 1 door 77.6 cm Carcase depth 10 cm For recess cladding</p>	<div style="border: 1px solid black; border-radius: 50%; width: 30px; height: 30px; display: flex; align-items: center; justify-content: center;">78</div>	<b>GPR 60 18 10 01</b>	R/L	258	268	308	448	477	498	549	604	-		



## Front filler 181.8 cm high

 <p><b>Tall unit front filler</b> one-part, 181.8 cm high 3.5 - 10 cm 10.1 - 20 cm</p>		 <b>Note: Models with horizontal veneer graining can only be supplied with 2-part front trim panel</b>										
		<b>GP 10 18</b>		85	85	93	144	144	144	157	173	-
		<b>GP 20 18</b>		93	93	107	170	170	170	182	200	-
 <p><b>Tall unit corner filler 90°</b> 181.8 cm high As corner connection between 2 tall units Without shelf, 9.5 x 9.5 cm</p>		<b>GPW 90 18</b>		124	124	137	200	200	200	214	235	-
		 <b>Note: Models with horizontal veneer graining can only be supplied with 2-part front trim panel</b>										
 <p><b>Tall unit corner filler 135°</b> 181.8 cm high For cladding blind corners Planning dimensions 25.9 x 25.9 cm</p>		<b>GPW 135 18</b>		124	124	137	200	200	200	214	235	-
		 <b>Note: Models with horizontal veneer graining can only be supplied with 2-part front trim panel</b>  <b>Not available for:</b> <b>ALU TEC RP</b>										





## Back cladding 181.8 cm high with screw-fitted fronts

 <p><b>906 906</b></p> <p><b>Back cladding</b> For tall units, 181.8 cm high Carcase material with screw-fitted fronts, 90.6 cm and 90.6 cm Only available in grid sizes</p>		per 10 cm Width										
		<b>GVF 18 03</b>		65	69	71	89	91	95	101	111	-
 <b>Important!</b> <b>Plinth panel is supplied loose.</b>												
 <p><b>1166 646</b></p> <p><b>Back cladding</b> For tall units, 181.8 cm high Carcase material with screw-fitted fronts 1 front 116.6 cm attached to 1 front 64.6 cm Only available in grid sizes</p>		per 10 cm Width										
		<b>GVF 18 02</b>		65	69	71	89	91	95	101	111	-
 <b>Important!</b> <b>Plinth panel is supplied loose.</b>												

# Back cladding 181.8 cm high

		Order no. W H D		Hinge side:	Carcase depth	Decor groups									
						M10	M20	M30	M40	M50	M60	M70	M80	M90	
	<b>Back cladding</b> For tall units, 181.8 cm high 16 mm thick	per 10 cm Width													
		<b>GVK 18</b>				27,50	48	66	87	87	87	87	87	87	-
	<b>Tall unit background filler</b> Width: 20 cm For fitting flush with carcass 181.8 cm high	Unit price													
		<b>GPSL 00 18</b>				45	53	103	138	138	138	138	138	138	-
<b>M 10</b>	<b>M 20</b>	<b>M 30</b>	<b>M 40</b>	<b>M 50</b>											
K M10 laminate	D M20 Laminate decor	I M30 RESOPAL PRO super matt IH M30 HPL PRO PW M30 PRIMEWOOD/Basic Veneer	A M40 DIRECTLACK matt L M40 DIRECTLACK high-gloss	B M50 Velvet lacquer S M50 microstructure lacquer											
<b>M 60</b>	<b>M 70</b>	<b>M 80</b>	<b>M 90</b>												
QH M60 SMARTGLAS high-gloss QM M60 SMARTGLAS satin-finish	F M70 veneer / oak / walnut Z M70 Veneer / Bavaria	C1 M80 FENIX stainless-steel look H M80 high gloss-Lacquer MP M80 laqué mat Premium													

## Visible sides / increased side depth 181.8 cm high

	<b>Tall unit visible side</b>  55.5 cm side depth Fixed dimension, not variable 57.5 cm side depth Fixed dimension, not variable 60.5 cm side depth Fixed dimension, not variable 61 cm side depth Fixed dimension, not variable	 <b>Important!</b> Installation instead of a normal unit side. Only available in the listed side depths. For other dimensions, use GSVT...														
		<b>GSV 18</b>	R/L	0	0	131	131	175	175	236	293	-				
		<b>GSV 18 5</b>	R/L	0	0	131	131	175	175	236	293	-				
		<b>GSV 18 6</b>	R/L	0	0	131	131	175	175	236	293	-				
		<b>GSV 18 6 1</b>	R/L	0	0	131	131	175	175	236	293	-				
	<b>Tall unit increased side depth</b>  from 61.1 cm up to 90 cm side depth Up to 60.9 cm side depth	 <b>Important!</b> Installation instead of a normal unit side.														
		<b>GSVT 18</b>	R/L	88	118	285	285	381	381	519	586	-				
		<b>GSVT 18 6</b>	R/L	45	58	192	192	257	257	346	426	-				
<b>M 10</b>	<b>M 20</b>	<b>M 30</b>	<b>M 40</b>	<b>M 50</b>												
K M10 laminate	D M20 Laminate decor	I M30 RESOPAL PRO super matt IH M30 HPL PRO PW M30 PRIMEWOOD/Basic Veneer	A M40 DIRECTLACK matt L M40 DIRECTLACK high-gloss	B M50 Velvet lacquer P M50 Soft lacquer RH M50 Velvet lacquer wood texture RW M50 Velvet lacquer spackle effect S M50 microstructure lacquer												
<b>M 60</b>	<b>M 70</b>	<b>M 80</b>	<b>M 90</b>													
QH M60 SMARTGLAS high-gloss QM M60 SMARTGLAS satin-finish	F M70 veneer / oak / walnut V M70 Velvet lacquer textured Z M70 Veneer / Bavaria	C1 M80 FENIX stainless-steel look H M80 high gloss-Lacquer MP M80 laqué mat Premium O M80 Veneered														





# Shelf units 181.8 cm high

Carcase depth 57.7 cm, flush with front

■ = = Models also available in 36.1/47.7/63.2 cm carcass depth  
(Order no.: replace ... 58 ... with 36/48/63)

Order no.  
W H D

## Decor groups

	Hinge side:	Carcass depth	Decor groups											
			M10	M20	M30	M40	M50	M60	M70	M80	M90			
 <p><b>Tall shelf unit</b> 1 fixed shelf 3 adjustable shelves wide in cm: 13-30 wide in cm: 30,1-40 wide in cm: 40,1-45 wide in cm: 45,1-50 wide in cm: 50,1-60</p>			<b>GR 30 18 58</b>	■	357	-	-	-	1335	-	1335	1335	-	
			<b>GR 40 18 58</b>	■	357	-	-	-	1335	-	1335	1335	-	
			<b>GR 45 18 58</b>	■	357	-	-	-	1335	-	1335	1335	-	
			<b>GR 50 18 58</b>	■	357	-	-	-	1335	-	1335	1335	-	
			<b>GR 60 18 58</b>	■	357	-	-	-	1335	-	1335	1335	-	
 <p><b>Tall shelf end unit</b> 25 x 57.7 cm 4 fixed shelves For adjacent fitting left or right</p> <p><i>Ill. left</i></p>			<b>GRA 25 18 58</b>	R/L	■	465	-	-	-	1148	-	1148	1148	-
	 <i>Important! Only available in 25 cm width</i>													
 <p><b>Tall shelf end unit</b> 34 x 57.7 cm 4 fixed shelves For adjacent fitting left or right</p> <p><i>Ill. left</i></p>			<b>GRA 34 18 58</b>	R/L	■	465	-	-	-	1314	-	1314	1314	-
<b>M 10</b>	<b>M 20</b>	<b>M 30</b>	<b>M 40</b>	<b>M 50</b>										
K M10 laminate				B M50 Velvet lacquer S M50 microstructure lacquer										
<b>M 60</b>	<b>M 70</b>	<b>M 80</b>	<b>M 90</b>											
	F M70 veneer / oak / walnut Z M70 Veneer / Bavaria	H M80 high gloss-Lacquer MP M80 laqué mat Premium												

# Raised dishwashers

For carcass height 181.8 cm, carcass depth 55.5 cm

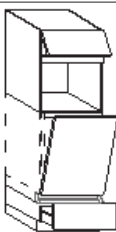
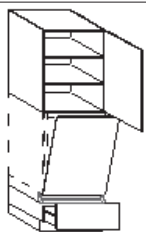
Pull-out panel at bottom 25.6 cm high

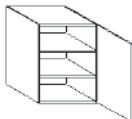
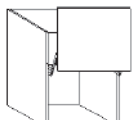
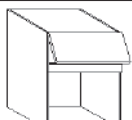

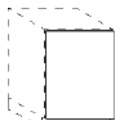








**Note:**

Do not plan at the end of a row. Only plan between tall units.

Always follow the assembly instructions from the appliance manufacturers.

▲ = Types also available with 61 cm carcass depth (order no. ... replace ... 55 ... with 61)



Order no. W H D		Hinge side: R/L ▲	Carcass depth	Price groups														
				1	2	3	4	5	6	7	8	9						
776		<b>Dresser unit above raised dishwasher</b> Height 79.3 cm 1 door 77.6 cm 2 adjustable shelves 1 vapour protector	A	60	79	55	R/L ▲	245	255	273	338	384	407	447	492	-		
256 516		<b>Dresser unit with lifting door for microwave above raised dishwasher</b> Height 79.3 cm 1 flap door 25.6 cm 1 lifting door with front 51.6 cm 1 vapour protector	ALT	60	79	55	▲	400	408	427	494	527	547	618	680	-		
256		<b>Dresser unit for microwave above raised dishwasher</b> Height 79.3 cm 1 flap door 25.6 cm 1 panel 1 appliance aperture 35 - 45 cm 1 vapour protector	35,0-45,0															
		 <b>Not available for:</b> ALU TEC RP, MIAMI, VIVA																
			AN	60	79	55	2	▲	359	360	371	394	394	402	422	464	-	
			AN	60	79	55	2A	▲	359	360	371	394	394	402	422	464	-	
776		<b>Base unit door, 77.6 cm</b> 59.6 cm wide As front panel for fully integrated dishwashers 86 cm high and pull-out fridges and freezers  59.6 cm wide with 60 cm																
		 <i>Always order article DL 60 6 if a high-volume dishwasher has not been included in planning!</i>																
			UT	60	78	1			122	126	138	146	232	253	294	323	-	
		<b>Spacer strips for fully integrated dishwasher</b> Appliance height 82 cm 2 spacer strips Colour: Art Pepper 6 cm high	DL	60	6				32									
256		<b>Base for raised dishwasher (86 cm high)</b> with top shelf, 15.5 cm high 1 drawer with pull-out panel 25.6 cm, 45.5 cm deep angled at top 1 collection tray (available only in 60 cm width)		UGS	60	10	55	87	▲	276	290	320	378	412	439	480	528	-
		 <b>Not available for:</b> ALU TEC RP																
		 <b>Important!</b> Plan free-standing with 25 mm panels																
256		<b>Base for raised dishwasher (86 cm high)</b> only for dishwashers with VARIO HINGE with top shelf, 15.5 cm high 1 drawer with pull-out panel 25.6 cm not angled 45.5 cm deep 1 collection tray (available only in 60 cm width)		UGV	60	10	55	87	▲	276	290	320	378	412	439	480	528	-
		 <b>Important!</b> Plan free-standing with 25 mm panels																

# Raised dishwashers

For carcass height 181.8 cm, carcass depth 55.5 cm

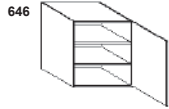
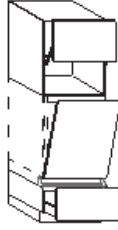
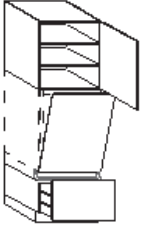
Pull-out panel at bottom 38.6 cm high

**Note:**

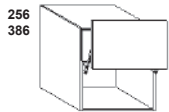
Do not plan at the end of a row. Only plan between tall units.

Always follow the assembly instructions from the appliance manufacturers.

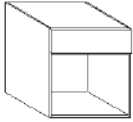
▲ = Types also available with 61 cm carcass depth (order no. ... replace ... 55 ... with 61)



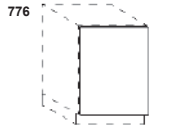
**Dresser unit above raised dishwasher**  
Height 66.3 cm  
1 door 64.6 cm  
2 adjustable shelves  
1 vapour protector



**Dresser unit with lifting door for microwave above raised dishwasher**  
Height 66.3 cm  
1 flap door 25.6 cm  
1 lifting door with front 38.6 cm  
1 vapour protector



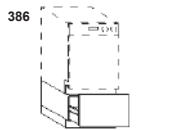
**Dresser unit for microwave above raised dishwasher**  
Height 66.3 cm  
1 panel  
1 appliance aperture 35 - 45 cm  
1 vapour protector



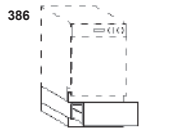
**Base unit door, 77.6 cm**  
59.6 cm wide  
As front panel for fully integrated dishwashers 86 cm high and pull-out fridges and freezers  
59.6 cm wide with 60 cm



**Spacer strips for fully integrated dishwasher**  
Appliance height 82 cm  
2 spacer strips  
Colour: Art Pepper 6 cm high



**Base for raised dishwasher (86 cm high)**  
with top shelf, 28.5 cm high  
1 pull-out 38.6 cm, 45.5 cm deep angled at top  
1 collection tray (available only in 60 cm width)



**Base for raised dishwasher (86 cm high)**  
only for dishwashers with **VARIO HINGE**  
with top shelf, 28.5 cm high  
1 pull-out panel 38.6 cm, 45.5 cm deep not angled  
1 collection tray (available only in 60 cm width)



**Vapour protector for raised dishwashers**  
Finish: metal  
to protect the fronts above

Order no.	W	H	D	Hinge side:	Carcass depth	Price groups									
						1	2	3	4	5	6	7	8	9	
646	A	60	66	55	R/L ▲	240	251	268	331	375	400	441	485	-	
256 386	ALT	60	66	55	▲	390	399	413	478	511	525	601	661	-	
	AN	60	66	55	2	▲	190	191	200	209	209	228	247	272	-
Width 60 Not available for: <i>ALU TEC RP</i>															
776	UT	60	78	1		122	126	138	146	232	253	294	323	-	
Always order article DL 60 6 if a high-volume dishwasher has not been included in planning!															
	DL	60	6			32									
386	UGS	60	11	55	87	▲	285	298	326	389	419	445	485	534	-
Not available for: <i>ALU TEC RP</i>															
Important! Plan free-standing with 25 mm panels															
386	UGV	60	11	55	87	▲	285	298	326	389	419	445	485	534	-
Important! Plan free-standing with 25 mm panels															
	WSB-45					11									
	WSB-60					12									



# Raised dishwashers

For carcass height 181.8 cm, carcass depth 55.5 cm

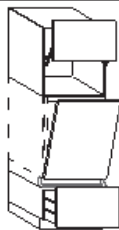
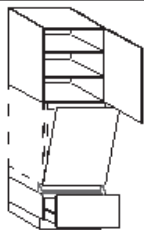
Pull-out panel at bottom 32.1 cm high

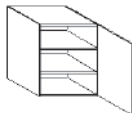
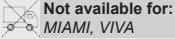
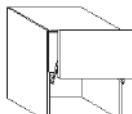
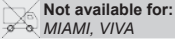


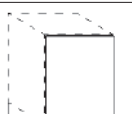
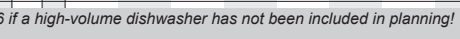


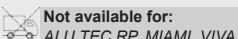

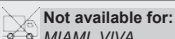
**Note:**

Do not plan at the end of a row. Only plan between tall units.

Always follow the assembly instructions from the appliance manufacturers.

▲ = Types also available with 61 cm carcass depth (order no. ... replace ... 55 ... with 61)



Order no. W H D		Hinge side: Carcase depth	Price groups									
			1	2	3	4	5	6	7	8	9	
711	 <p><b>Dresser unit above raised dishwasher</b> Height 72.8 cm 1 door 71.1 cm 2 adjustable shelves 1 vapour protector</p>	A 60 73 55	R/L ▲	240	251	268	331	375	400	441	485	-
												
321 386	 <p><b>Dresser unit with lifting door for microwave above raised dishwasher</b> Height 72.8 cm 1 flap door 32.1 cm 1 lifting door with front 38.6 cm 1 vapour protector</p>	ALT 60 73 55	▲	390	399	413	478	511	525	601	661	-
												
	 <p><b>Dresser unit for microwave above raised dishwasher</b> Height 72.8 cm 1 panel 1 appliance aperture 35 - 45 cm 1 vapour protector</p>	35,0-45,0 AN 60 73 55 2	▲	240	251	268	331	375	400	441	485	-
												
776	 <p><b>Base unit door, 77.6 cm</b> 59.6 cm wide As front panel for fully integrated dishwashers 86 cm high and pull-out fridges and freezers 59.6 cm wide with 60 cm</p>											
		UT 60 78 1		122	126	138	146	232	253	294	323	-
	 <p><b>Spacer strips for fully integrated dishwasher</b> Appliance height 82 cm 2 spacer strips Colour: Art Pepper 6 cm high</p>	DL 60 6		32								
321	 <p><b>Base for raised dishwasher with top shelf, 22.0 cm high</b> 1 drawer with pull-out panel 32.1 cm, 45.5 cm deep, angled at top 1 collection tray (available only in 60 cm width)</p>	UGS 60 15 55 871	▲	276	290	320	378	412	439	480	528	-
		 <p><b>Important!</b> Plan free-standing with 25 mm panels</p>										
	 <p><b>Base for raised dishwasher only for dishwashers with VARIO HINGE</b> with top shelf, 22.0 cm high 1 drawer with pull-out panel 32.1 cm, 45.5 cm deep, not chamfered 1 collection tray (available only in 60 cm width)</p>	UGV 60 15 55 871	▲	276	290	320	378	412	439	480	528	-
		 <p><b>Important!</b> Plan free-standing with 25 mm panels</p>										

# Raised dishwashers

For carcass height 181.8 cm, carcass depth 55.5 cm

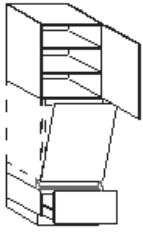
Pull-out panel at bottom 45.1 cm high

**Note:**

Do not plan at the end of a row. Only plan between tall units.

Always follow the assembly instructions from the appliance manufacturers.

▲ = Types also available with 61 cm carcass depth (order no. ... replace ... 55 ... with 61)



		Order no. W H D			Hinge side: R/L ▲	Carcass depth	Price groups								
		1	2	3			4	5	6	7	8	9			
581	<p><b>Dresser unit above raised dishwasher</b> Height 59.8 cm 1 door 58.1 cm 1 adjustable shelf 1 vapour protector</p>	<b>A 60 60 55</b>	R/L ▲	240	251	268	331	375	400	441	485	-			
581	<p><b>Dresser unit with lifting door for microwave above raised dishwasher</b> Height 59.8 cm 1 lifting door with front 58.1 cm 1 vapour protector</p>	<b>ALT 60 60 55</b>	▲	390	399	413	478	511	525	601	661	-			
	<p><b>Dresser unit for microwave above raised dishwasher</b> Height 59.8 cm 1 panel 1 appliance aperture 35 - 45 cm 1 vapour protector</p>	<b>AN 60 60 55 2</b> Width 60 Not available for: <i>ALU TEC RP</i>	▲	240	251	268	331	375	400	441	485	-			
776	<p><b>Base unit door, 77.6 cm</b> 59.6 cm wide As front panel for fully integrated dishwashers 86 cm high and pull-out fridges and freezers 59.6 cm wide with 60 cm</p>			Always order article DL 60 6 if a high-volume dishwasher has not been included in planning!											
	<p><b>Spacer strips for fully integrated dishwasher</b> Appliance height 82 cm 2 spacer strips Colour: Art Pepper 6 cm high</p>	<b>DL 60 6</b>		122	126	138	146	232	253	294	323	-			
451	<p><b>Base for raised dishwasher (86 cm high)</b> with top shelf, 35.0 cm high 1 pull-out 45.1 cm, 45.5 cm deep angled at top 1 collection tray (available only in 60 cm width)</p>	<b>UGS 60 12 55 87</b> Not available for: <i>ALU TEC RP</i> Important! Plan free-standing with 25 mm panels	▲	295	306	337	401	431	459	500	550	-			
451	<p><b>Base for raised dishwasher (86 cm high)</b> only for dishwashers with <b>VARIO HINGE</b> with top shelf, 35.0 cm high 1 pull-out panel 45.1 cm, 45.5 cm deep not angled 1 collection tray (available only in 60 cm width)</p>	<b>UGV 60 12 55 87</b> Not available for: <i>ALU TEC RP</i> Important! Plan free-standing with 25 mm panels	▲	295	306	337	401	431	459	500	550	-			

# 6.5

## Tall units 194.8 cm high

Tall units 194.8 cm high	XL 6.5.3-XL 6.5.7
Tall units 194.8 cm high with glass fronts	XL 6.5.8
Additional equipment	XL 6.5.8
Tall units 194.8 cm high with roller shutter	XL 6.5.8-XL 6.5.9
Appliance unit 194.8 cm high for microwave / oven	XL 6.5.9-XL 6.5.12
Appliance unit 194.8 cm high for microwave / oven Double aperture	XL 6.5.12-XL 6.5.13
Appliance unit 194.8 cm high for microwave / oven Lifting door / aperture	XL 6.5.13-XL 6.5.14
Appliance unit 194.8 cm high for microwave / oven 30 inches wide (76.2 cm)	XL 6.5.14-XL 6.5.15
Appliance unit 194.8 cm high for refrigerator/freezer	XL 6.5.15-XL 6.5.18
Appliance unit 194.8 cm high for refrigerator/freezer Double aperture	XL 6.5.18
spacefitter frame 194.8 cm high	XL 6.5.18-XL 6.5.19
Passage door elements 194.8 cm high	XL 6.5.19-XL 6.5.20
Front filler 194.8 cm high	XL 6.5.21
Back cladding 194.8 cm high with screw-fitted fronts	XL 6.5.21
Back cladding 194.8 cm high	XL 6.5.21
Visible sides / increased side depth 194.8 cm high	XL 6.5.22
Shelf units 194.8 cm high	XL 6.5.22
Raised dishwashers For carcass height 194.8 cm, carcass depth 55.5 cm	XL 6.5.23
Raised dishwashers For carcass height 194.8 cm, carcass depth 55.5 cm	XL 6.5.24
Raised dishwashers For carcass height 194.8 cm, carcass depth 55.5 cm	XL 6.5.25
Raised dishwashers For carcass height 194.8 cm, carcass depth 55.5 cm	XL 6.5.26

### Legend:



Available with grip ledge N...



Not available with grip ledge N...



This symbol indicates which models are available



This symbol indicates which models are not available



wall-mounted units



available depths for wall-mounted units



Planning advice



This symbol illustrates which appliance units are delivered with integrated ventilation



Not available with „push-to-open“ fitting



Aperture height specifications



Available carcass depths 34/45.5/55.5/61.0 cm



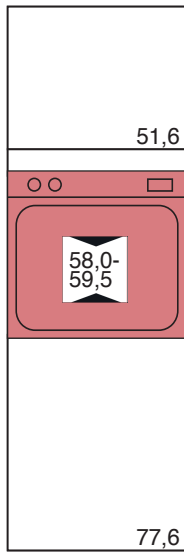
Available carcass depths 45.5/55.5/61.0 cm



Available carcass depths 55.5/61.0 cm

## Planning advice for appliance shelves with compensation panels or compensation door

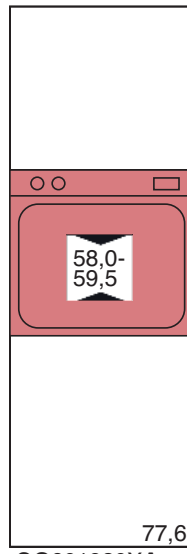
Height  
194,8 cm



GO60195520X

Door

Compensation  
panel



GO601920XA

Compensation door  
51.6 cm + Compensation panel






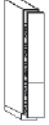




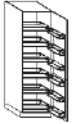
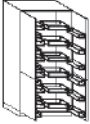
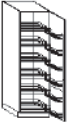
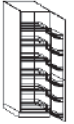
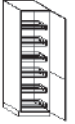
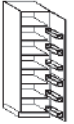
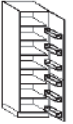

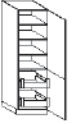


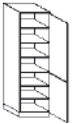

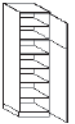



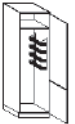
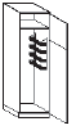

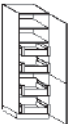

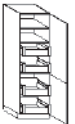
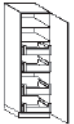



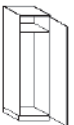
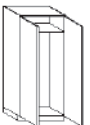
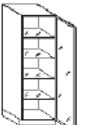





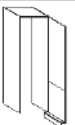

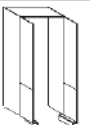
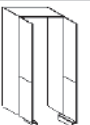
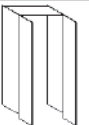

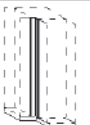


Compensation lifting door  
38.6 cm + compensation panel

By changing the order number, the compensation panels above the appliance apertures can be replaced by a special-size door or lifting door.





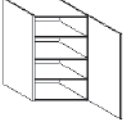
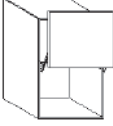
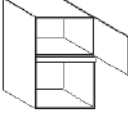
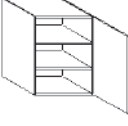
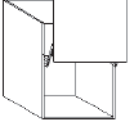
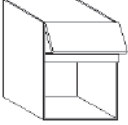
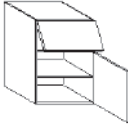

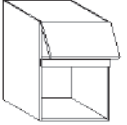
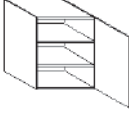
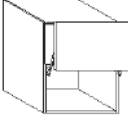
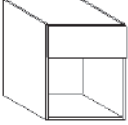


**Not available for models:  
MIAMI, VIVA**

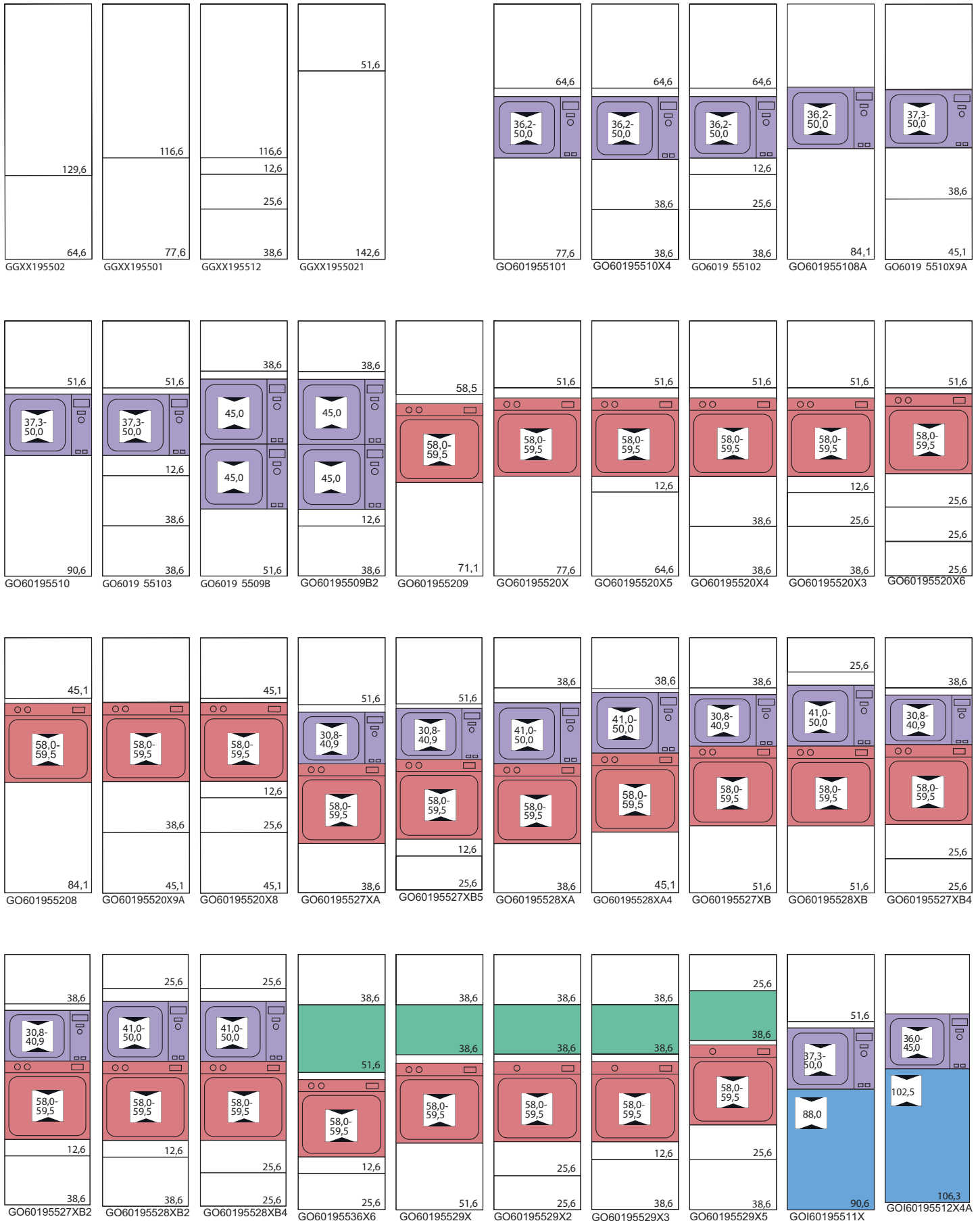
# The most important tall unit types 194.8 cm

Page XL 6.5.3	Page XL 6.5.3	Page XL 6.5.3	Page XL 6.5.3	Page XL 6.5.3	Page XL 6.5.3	Page XL 6.5.3	Page XL 6.5.3	Page XL 6.5.3
								
GGG..195502 Unit widths: 25	GGG..195501 Unit widths: 25	GVSTP..195502 Unit widths: 25	GVSTP..195501 Unit widths: 25	GV..195502 Unit widths: 30/45	GV..195501 Unit widths: 30/45	GV..195570 Unit widths: 30/45	GVP..195502 Unit widths: 30/45	GVP..195501 Unit widths: 30/45
Page XL 6.5.3	Page XL 6.5.3	Page XL 6.5.4	Page XL 6.5.4	Page XL 6.5.4	Page XL 6.5.4	Page XL 6.5.4	Page XL 6.5.4	Page XL 6.5.4
								
GVP..195570 Unit widths: 30/45	GVP..195501 Unit widths: 50/60	GVP..0195501 Unit widths: 100	GV..195502 Unit widths: 30/45/50/60	GV..195501 Unit widths: 30/45/50/60	GVPS..1955 Unit widths: 60	GVT..195501 Unit widths: 50/60	GVPT..195501 Unit widths: 50/60	GG..195502 Unit widths: 30/40/45/50/60
Page XL 6.5.4	Page XL 6.5.4	Page XL 6.5.5	Page XL 6.5.5	Page XL 6.5.5	Page XL 6.5.5	Page XL 6.5.5	Page XL 6.5.5	Page XL 6.5.5
								
GGA..195508 Unit widths: 30/40/45/50/60	GG..195573 Unit widths: 30/40/45/50/60	GG..195512 Unit widths: 30/40/45/50/60	GG..195505 Unit widths: 30/40/45/50/60	GGA..1955081 Unit widths: 30/40/45/50/60	GG..1955021 Unit widths: 30/40/45/50/60	GG..195501 Unit widths: 80/90	GG..195570 Unit widths: 30/40/45/50/60	GB..195502 Unit widths: 30/40/45/50/60
Page XL 6.5.5	Page XL 6.5.5	Page XL 6.5.6	Page XL 6.5.6	Page XL 6.5.6	Page XL 6.5.7	Page XL 6.5.7	Page XL 6.5.7	Page XL 6.5.7
								
GB..195501 Unit widths: 30/40/45/50/60	GB..1955021 Unit widths: 30/40/45/50/60	GB..195570 Unit widths: 30/40/45/50/60	GGA..195501 Unit widths: 30/40/45/50/60	GGA..195502 Unit widths: 30/40/45/50/60	GGA..195506 Unit widths: 30/40/45/50/60	GGA..195571 Unit widths: 30/40/45/50/60	GGA..195572 Unit widths: 30/40/45/50/60	GGA..195503 Unit widths: 90
Page XL 6.5.7	Page XL 6.5.7	Page XL 6.5.7	Page XL 6.5.8	Page XL 6.5.9	Page XL 6.5.18	Page XL 6.5.19	Page XL 6.5.19	Page XL 6.5.19
								
GGA..195502 Unit widths: 90/100	GK..196170 Unit widths: 45/50/60	GK..196170 Unit widths: 90/100	GGGD..195570 Unit widths: 45/50/60	TAB-AZ..55 Unit widths: 45/50/60/80/90	GPR..191002 Unit widths: 30/45/50/60	GPR..191001 Unit widths: 30/45/50/60	GPRS..191002 Unit widths: 60/70/80	GPRS..191001 Unit widths: 60/70/80
Page XL 6.5.19	Page XL 6.5.19	Page XL 6.5.20	Page XL 6.5.20	Page XL 6.5.20	Page XL 6.5.21	Page XL 6.5.21	Page XL 6.5.21	Page XL 6.5.21
								
GDT..195502 Unit widths: 60/70/80	GDT..195501 Unit widths: 60/70/80	GDT..195502 Unit widths: 90/100/120	GDT..195501 Unit widths: 90/100/120	GDTV..195570 Unit widths: 90/100/120	GP..19 Unit widths: 3,5-20	GPW..19 Unit widths: 9,9x9,5	GPW..19 Unit widths: 25,9x25,9	GVF..01 Unit widths: 10-250

# The most important tall unit types 194.8 cm

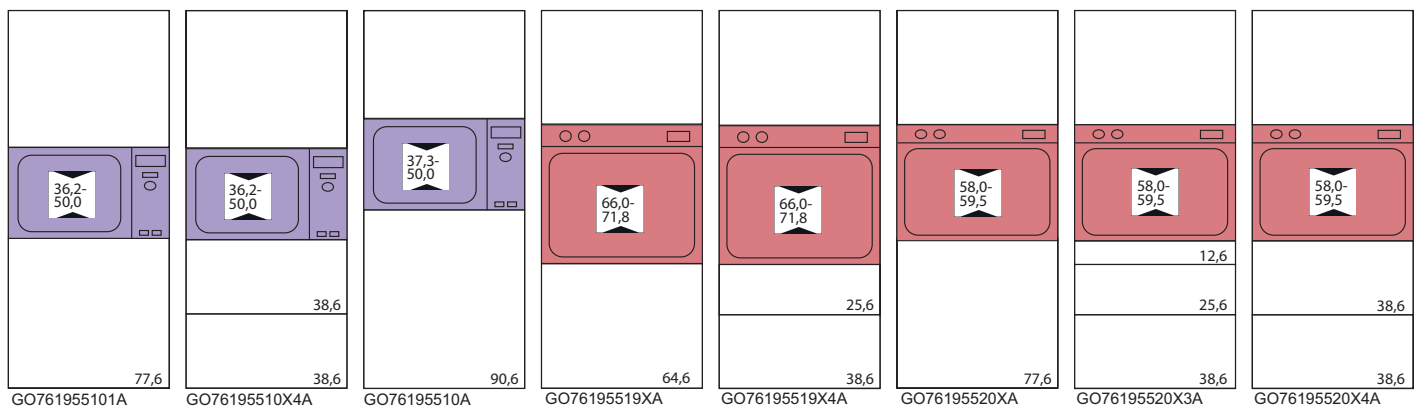
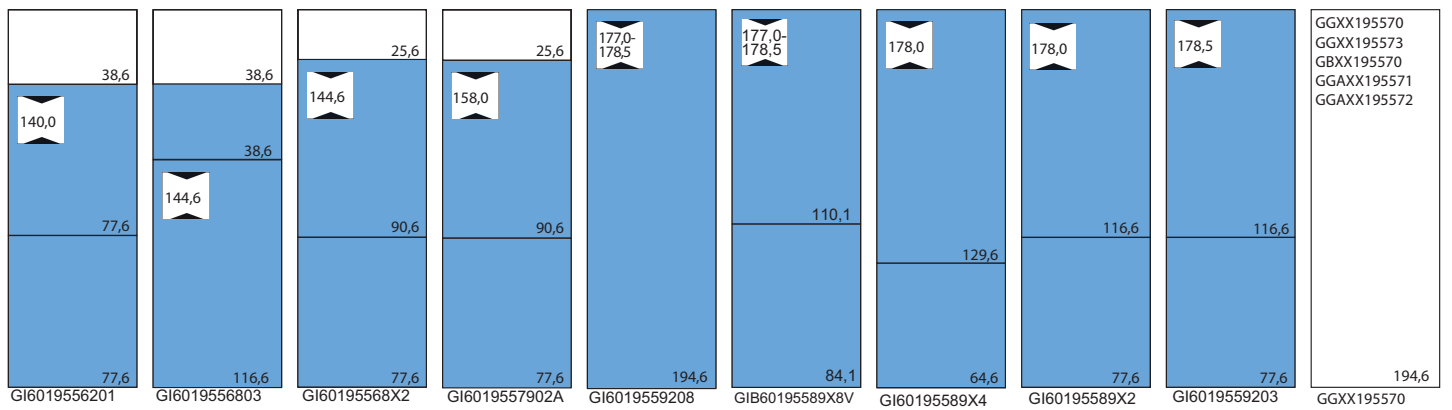
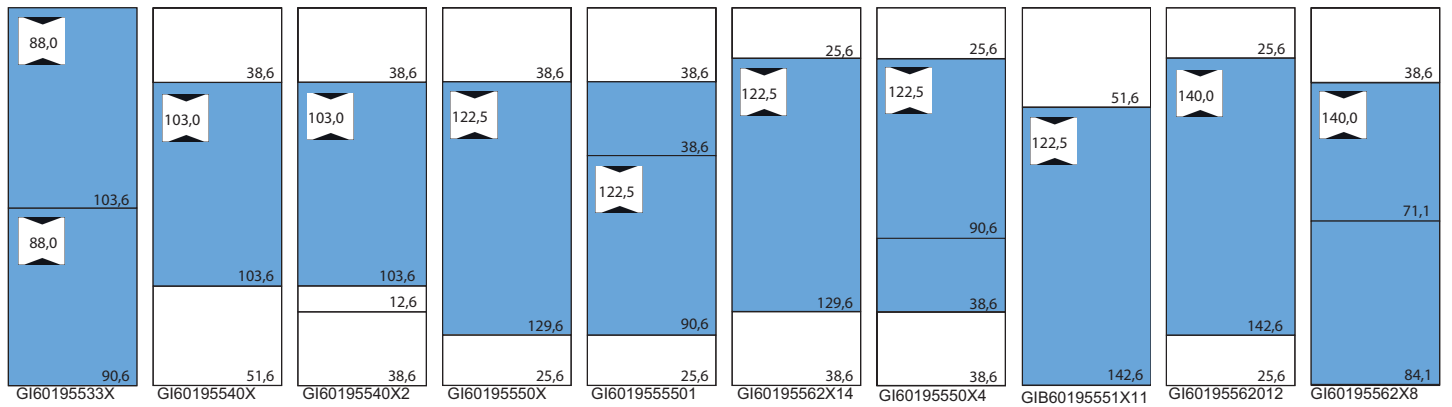
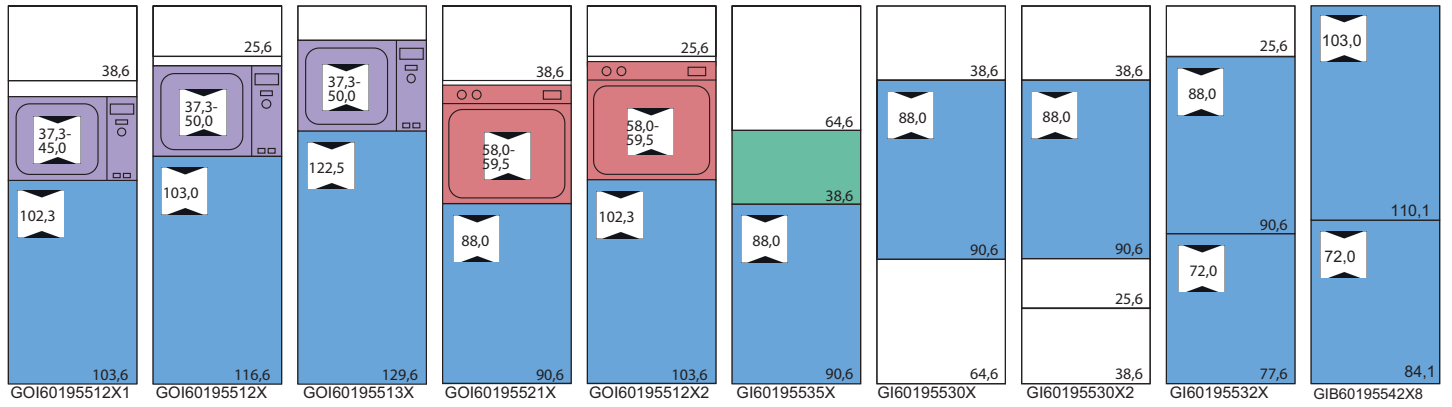
Page XL 6.5.21	Page XL 6.5.22	Page XL 6.5.22	Page XL 6.5.22	Page XL 6.5.23	Page XL 6.5.23	Page XL 6.5.23	Page XL 6.5.24	Page XL 6.5.24
								
<b>GVF..02</b> Unit widths: 10-250	<b>GR..1958</b> Unit widths: 30/40/45/50/60	<b>GRA..1958</b> Unit widths: 25/34	<b>GRA..1958</b> Unit widths: 25/34	<b>A..9255</b> Unit widths: 60	<b>ALT..9255</b> Unit widths: 60	<b>AN..92552</b> Unit widths: 60	<b>A..7955</b> Unit widths: 60	<b>ALT..7955</b> Unit widths: 60
Page XL 6.5.24	Page XL 6.5.25	Page XL 6.5.25	Page XL 6.5.25	Page XL 6.5.26	Page XL 6.5.26	Page XL 6.5.26		
								
<b>AN..79552</b> Unit widths: 60	<b>A..8555</b> Unit widths: 60	<b>ALT..8555</b> Unit widths: 60	<b>AN..85552</b> Unit widths: 60	<b>A..7355</b> Unit widths: 60	<b>ALT..7355</b> Unit widths: 60	<b>AN..73552</b> Unit widths: 60		

# Recess overview Tall units 194.8 cm





# Recess overview Tall units 194.8 cm



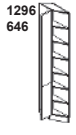
# Tall units 194.8 cm high

Carcase depth 55.5 cm (standard)

- = Models also available in 34/45.5/61 cm carcass depth (Order no.: ... replace ... 55 ... with 34/45/61)
- = Models also available in 45.5/61 cm carcass depth (order no.: replace ... 55 ... with 45/61)
- ▲ = Types also available with 61 cm carcass depth (order no.: ... replace ... 55 ... with 61)

Order no.  
W H D

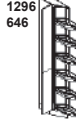
				Price groups											
Hinge side:	Carcass depth														
		1	2	3	4	5	6	7	8	9					
R/L	■	GGG	25	19	55	02	534	549	598	732	787	814	873	960	-
R/L	■	GGG	25	19	55	01	534	549	598	732	787	814	873	960	-
R/L	▲	GVSTP25	19	55	02	1296	1314	1363	1479	1533	1560	1621	1783	-	
R/L	▲	GVSTP25	19	55	01	1296	1314	1363	1479	1533	1560	1621	1783	-	
	▲	GV	30	19	55	02	861	887	908	1037	1087	1133	1219	1341	-
	▲	GV	45	19	55	02	919	946	975	1106	1160	1217	1313	1444	-
	▲	GV	30	19	55	01	861	887	908	1037	1087	1133	1219	1341	-
	▲	GV	45	19	55	01	919	946	975	1106	1160	1217	1313	1444	-
	▲	GV	30	19	55	70	943	969	989	1117	1168	1214	1299	1429	-
	▲	GV	45	19	55	70	1001	1026	1057	1186	1242	1296	1394	1533	-
<p><b>Not available for:</b>                      ALUELEMENTS, ATLANTA-B, ATLANTA-S, BERGEN, CASTELLO, CHALET-B, CHALET-S, CHICAGO, FRAME, LUGANO, LUX-B, MIAMI, MODENA, MUNICH, NEVADA, NOBEL-B, NOBEL-S, ORLANDO-B, ORLANDO-S, OSLO 15, PADUA, SOFIE-B, SOFIE-S, TESSIN 15, TIM 15, VINO, VIVA, YORK-B, YORK-S</p>															
	▲	GVP	30	19	55	02	1028	1056	1074	1200	1251	1294	1383	1521	-
	▲	GVP	45	19	55	02	1087	1114	1144	1271	1325	1383	1477	1625	-
	▲	GVP	30	19	55	01	1028	1056	1074	1200	1251	1294	1383	1521	-
	▲	GVP	45	19	55	01	1087	1114	1144	1271	1325	1383	1477	1625	-
	▲	GVP	30	19	55	70	1110	1136	1154	1280	1332	1378	1463	1609	-
	▲	GVP	45	19	55	70	1168	1196	1225	1350	1406	1463	1558	1714	-
<p><b>Not available for:</b>                      ALUELEMENTS, ATLANTA-B, ATLANTA-S, BERGEN, CASTELLO, CHALET-B, CHALET-S, CHICAGO, FRAME, LUGANO, LUX-B, MIAMI, MODENA, MUNICH, NEVADA, NOBEL-B, NOBEL-S, ORLANDO-B, ORLANDO-S, OSLO 15, PADUA, SOFIE-B, SOFIE-S, TESSIN 15, TIM 15, VINO, VIVA, YORK-B, YORK-S</p>															
R/L	▲	GVP	50	19	55	01	1973	1986	2037	2131	2175	2204	2266	2493	-
R/L	▲	GVP	60	19	55	01	2075	2096	2153	2291	2350	2381	2451	2696	-
<p><b>Planungshinweis:</b>                      Türen mit Weitwinkelscharnieren dürfen grundsätzlich nicht neben Schränken oder Wangen verplant werden, wenn der Überstand der angrenzenden Artikel nach vorne größer als 3 cm ist (Anschlagseite). Türen mit Weitwinkelscharnieren stehen nach außen über der Korpusseite.</p>															



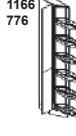
Ill. left



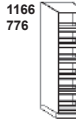
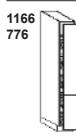
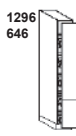
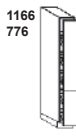
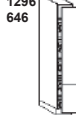
Ill. left



Ill. left



Ill. left

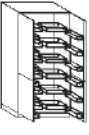
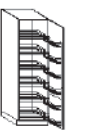
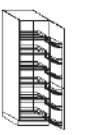
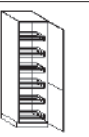
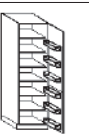
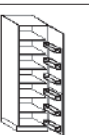
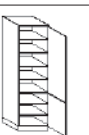
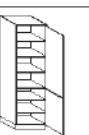
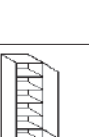



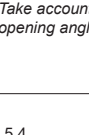


# Tall units 194.8 cm high

Carcase depth 55.5 cm (standard)

■ = Models also available in 34/45.5/61 cm carcass depth (Order no.: ... replace ... 55 ... with 34/45/61)  
 □ = Models also available in 45.5/61 cm carcass depth (order no.: replace ... 55 ... with 45/61)  
 ▲ = Types also available with 61 cm carcass depth (order no. ... replace ... 55 ... with 61)

Order no.  
W H D

Hinge side:	Carcass depth	Price groups														
		1	2	3	4	5	6	7	8	9						
		1166 776		<b>Larder unit</b> 2 doors 116.6 cm with 2 doors 77.6 cm 2 swivel and pull-out elements each 6 adjustable and each connected with 6 adjustable wooden shelves with chrome-plated square rail	78	GVP 100 19 55 01	▲	3933	3961	4065	4247	4339	4397	4519	4971	-
		1296 646		<b>Larder unit</b> 1 door 129.6 cm connected to 1 door 64.6 cm 1 swivel and pull-out element 6 adjustable and 6 removable wire baskets (chrome-plated)		GV 50 19 55 02 GV 60 19 55 02	R/L ▲	1595 1673	1609 1692	1660 1751	1761 1898	1806 1957	1835 1989	1895 2056	2085 2262	-
		1166 776		<b>Larder unit</b> 1 door 116.6 cm connected to 1 door 77.6 cm 1 swivel and pull-out element 6 adjustable and 6 removable wire baskets (chrome-plated)	78	GV 50 19 55 01 GV 60 19 55 01	R/L ▲	1595 1673	1609 1692	1660 1751	1761 1898	1806 1957	1835 1989	1895 2056	2085 2262	-
		1166 776		<b>Larder unit</b> 1 door 116.6 cm connected to 1 door 77.6 cm 1 pull-out element 6 adjustable wooden shelves with chrome-plated square rail	78	GVPS 60 19 55	R/L ▲	1520	1540	1594	1806	1861	1895	1968	2165	-
		1166 776		<b>Larder unit</b> 1 door 116.6 cm connected to 1 door 77.6 cm 6 chrome-plated wire baskets Adjustable in height 6 adjustable shelves reduced in depth	78	GVT 50 19 55 01 GVT 60 19 55 01	R/L ▲	862 928	875 943	926 1002	1061 1183	1105 1239	1135 1271	1196 1343	1316 1477	-
		1166 776		<b>Larder unit</b> 1 door 116.6 cm connected to 1 door 77.6 cm 6 wooden shelves with chrome-plated square rail Adjustable in height 6 adjustable shelves reduced in depth	78	GVPT 50 19 55 01 GVPT 60 19 55 01	R/L ▲	915 978	926 993	978 1052	1112 1232	1155 1289	1187 1322	1248 1394	1373 1533	-
		1296 646		<b>Crockery cupboard</b> 1 door 129.6 cm 1 door 64.6 cm 1 fixed shelf 6 adjustable shelves		GG 30 19 55 02 GG 40 19 55 02 GG 45 19 55 02 GG 50 19 55 02 GG 60 19 55 02	R/L ■	353 353 353 353 390	369 369 369 369 409	418 418 418 418 463	555 555 555 606 701	610 610 610 652 758	637 637 637 681 791	699 699 699 740 862	769 769 769 814 948	-
		1231 711		<b>Crockery cupboard</b> 1 door 123.1 cm 1 door 71.1 cm 1 fixed shelf 5 adjustable shelves	71,5 NEW	GG 30 19 55 07 GG 40 19 55 07 GG 45 19 55 07 GG 50 19 55 07 GG 60 19 55 07	R/L ■	353 353 353 353 390	369 369 369 369 409	418 418 418 418 463	555 555 555 606 701	610 610 610 652 758	637 637 637 681 791	699 699 699 740 862	769 769 769 814 948	-
		1166 776		<b>Crockery cupboard</b> 1 door 116.6 cm 1 door 77.6 cm 1 fixed shelf 5 adjustable shelves	78	GG 30 19 55 01 GG 40 19 55 01 GG 45 19 55 01 GG 50 19 55 01 GG 60 19 55 01	R/L ■	353 353 353 353 390	369 369 369 369 409	418 418 418 418 463	555 555 555 606 701	610 610 610 652 758	637 637 637 681 791	699 699 699 740 862	769 769 769 814 948	-
		1166 776		<b>Crockery cupboard</b> 1 door 116.6 cm 3 adjustable shelves 1 fixed shelf 1 door 77.6 cm with wide angle hinges 2 internal pull-outs	78 NEW	GGA 30 19 55 08 GGA 40 19 55 08 GGA 45 19 55 08 GGA 50 19 55 08 GGA 60 19 55 08	R/L ■	709 709 709 709 746	725 725 725 725 765	774 774 774 774 819	911 911 911 962 1057	966 966 966 1008 1114	993 993 993 1037 1147	1055 1055 1055 1096 1218	1161 1161 1161 1206 1340	-
		1166 776		<b>Planning advice:</b> Take account of opening angle			▲	The adjustable shelves will be delivered as a separate package.								
		1166 776		<b>Crockery cupboard</b> 1 door 116.6 cm 3 adjustable shelves 1 door 77.6 cm with wide angle hinges 3 internal drawers	78	GG 30 19 55 73 GG 40 19 55 73 GG 45 19 55 73 GG 50 19 55 73 GG 60 19 55 73	R/L ■	697 697 697 697 735	713 713 713 713 752	763 763 763 763 807	901 901 901 951 1045	955 955 955 996 1101	979 979 979 1025 1136	1043 1043 1043 1085 1207	1147 1147 1147 1194 1328	-
		1166 776		<b>Planning advice:</b> Take account of opening angle			▲	The adjustable shelves will be delivered as a separate package.								

# Tall units 194.8 cm high

Carcase depth 55.5 cm (standard)

■ = Models also available in 34/45.5/61 cm carcass depth (Order no.: ... replace ... 55 ... with 34/45/61)  
 □ = Models also available in 45.5/61 cm carcass depth (order no.: replace ... 55 ... with 45/61)  
 ▲ = Types also available with 61 cm carcass depth (order no.: ... replace ... 55 ... with 61)

Order no.  
W H D

Hinge side:	Carcass depth	Price groups											
		1	2	3	4	5	6	7	8	9			
R/L	■	78	GG 30 19 55 12	828	846	895	1031	1085	1111	1174	1291	-	
			GG 40 19 55 12	828	846	895	1031	1085	1111	1174	1291	-	
			GG 45 19 55 12	828	846	895	1031	1085	1111	1174	1291	-	
			GG 50 19 55 12	828	846	895	1082	1129	1154	1217	1339	-	
			GG 60 19 55 12	864	884	936	1177	1231	1268	1339	1473	-	
R/L	■	84,5	GG 30 19 55 05	353	369	418	555	610	637	699	769	-	
			GG 40 19 55 05	353	369	418	555	610	637	699	769	-	
			GG 45 19 55 05	353	369	418	555	610	637	699	769	-	
			GG 50 19 55 05	353	369	418	606	652	681	740	814	-	
			GG 60 19 55 05	390	409	463	701	758	791	862	948	-	
<p>Not available for: MIAMI, VIVA</p>													
R/L	■	84,5	NEW	GGA 30 19 55 081	709	725	774	911	966	993	1055	1161	-
				GGA 40 19 55 081	709	725	774	911	966	993	1055	1161	-
				GGA 45 19 55 081	709	725	774	911	966	993	1055	1161	-
				GGA 50 19 55 081	709	725	774	962	1008	1037	1096	1206	-
				GGA 60 19 55 081	746	765	819	1057	1114	1147	1218	1340	-
<p>Width 30, 40, 45, 50, 60 Not available for: MIAMI, VIVA</p>													
<p>Planning advice: Doors with wide angle hinges may not be planned alongside units or panels if the protrusion to the front of the adjoining article is greater than 3 cm (hinge side). Doors with wide angle hinges protrude over the carcass side.</p>													
R/L	■		GG 30 19 55 021	353	369	418	555	610	637	699	769	-	
			GG 40 19 55 021	353	369	418	555	610	637	699	769	-	
			GG 45 19 55 021	353	369	418	555	610	637	699	769	-	
			GG 50 19 55 021	353	369	418	606	652	681	740	814	-	
			GG 60 19 55 021	390	409	463	701	758	791	862	948	-	
R/L	■	78	GG 80 19 55 01	796	830	925	1087	1152	1208	1329	1462	-	
			GG 90 19 55 01	796	830	925	1087	1152	1208	1329	1462	-	
R/L	■		GG 30 19 55 70	434	448	498	638	691	717	779	857	-	
			GG 40 19 55 70	434	448	498	638	691	717	779	857	-	
			GG 45 19 55 70	434	448	498	638	691	717	779	857	-	
			GG 50 19 55 70	434	448	498	688	734	762	823	905	-	
			GG 60 19 55 70	472	489	543	782	838	871	944	1038	-	
<p>Not available for: ALUELEMENTS, ATLANTA-B, ATLANTA-S, BERGEN, CASTELLO, CHALET-B, CHALET-S, CHICAGO, FRAME, LUGANO, LUX-B, MIAMI, MODENA, MUNICH, NEVADA, NOBEL-B, NOBEL-S, ORLANDO-B, ORLANDO-S, OSLO 15, PADUA, SOFIE-B, SOFIE-S, TESSIN 15, TIM 15, VINO, VIVA, YORK-B, YORK-S</p>													
<p>Each front has a tightening fitting Ranges without fitting: SMARTGLAS, NOBEL, SOFIE, YORK, LUGANO, TALEA, RIVA, GARDA, ATLANTA, ORLANDO, CHICAGO without tightening fitting</p>													
R/L	□		GB 30 19 55 02	353	369	418	555	610	637	699	769	-	
			GB 40 19 55 02	353	369	418	555	610	637	699	769	-	
			GB 45 19 55 02	353	369	418	555	610	637	699	769	-	
			GB 50 19 55 02	353	369	418	606	652	681	740	814	-	
			GB 60 19 55 02	390	409	463	701	758	791	862	948	-	
R/L	□	78	GB 30 19 55 01	353	369	418	555	610	637	699	769	-	
			GB 40 19 55 01	353	369	418	555	610	637	699	769	-	
			GB 45 19 55 01	353	369	418	555	610	637	699	769	-	
			GB 50 19 55 01	353	369	418	606	652	681	740	814	-	
			GB 60 19 55 01	390	409	463	701	758	791	862	948	-	
R/L	□		GB 30 19 55 021	353	369	418	555	610	637	699	769	-	
			GB 40 19 55 021	353	369	418	555	610	637	699	769	-	
			GB 45 19 55 021	353	369	418	555	610	637	699	769	-	
			GB 50 19 55 021	353	369	418	606	652	681	740	814	-	
			GB 60 19 55 021	390	409	463	701	758	791	862	948	-	

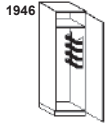
# Tall units 194.8 cm high

Carcase depth 55.5 cm (standard)

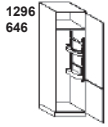
■ = Models also available in 34/45.5/61 cm carcass depth (Order no.: ... replace ... 55 ... with 34/45/61)  
 □ = Models also available in 45.5/61 cm carcass depth (order no.: replace ... 55 ... with 45/61)  
 ▲ = Types also available with 61 cm carcass depth (order no. ... replace ... 55 ... with 61)

Order no.  
W H D

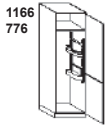
Hinge side:	Carcass depth	Price groups								
		1	2	3	4	5	6	7	8	9
R/L	□	434	448	498	638	691	717	779	857	-
	□	434	448	498	638	691	717	779	857	-
	□	434	448	498	638	691	717	779	857	-
	□	434	448	498	688	734	762	823	905	-
	□	472	489	543	782	838	871	944	1038	-
<p><b>Not available for:</b>                      ALUELEMENTS, ATLANTA-B, ATLANTA-S, BERGEN, CASTELLO, CHALET-B, CHALET-S, CHICAGO, FRAME, LUGANO, LUX-B, MIAMI, MODENA, MUNICH, NEVADA, NOBEL-B, NOBEL-S, ORLANDO-B, ORLANDO-S, OSLO 15, PADUA, SOFIE-B, SOFIE-S, TESSIN 15, TIM 15, VINO, VIVA, YORK-B, YORK-S</p> <p>Each front has a tightening fitting                      Ranges without fitting: SMARTGLAS, NOBEL, SOFIE, YORK, LUGANO, TALEA, RIVA, GARDA, ATLANTA, ORLANDO, CHICAGO without tightening fitting</p>										
R/L	▲	540	555	604	742	796	824	885	974	-
	▲	540	555	604	742	796	824	885	974	-
	▲	540	555	604	793	838	867	926	1019	-
	▲	577	596	650	887	944	977	1048	1153	-
	<p><b>Optional accessories</b>                      HW HS Holder for vacuum cleaner hose or PET storage pocket (for screwing on), anthracite                      HW UTB Utensils box, e.g. for storing towels, cleaning cloths, etc. (for screwing on), anthracite</p>									
R/L	▲	540	555	604	742	796	824	885	974	-
	▲	540	555	604	742	796	824	885	974	-
	▲	540	555	604	793	838	867	926	1019	-
	▲	577	596	650	887	944	977	1048	1153	-
	<p><b>Optional accessories</b>                      HW HS Holder for vacuum cleaner hose or PET storage pocket (for screwing on), anthracite                      HW UTB Utensils box, e.g. for storing towels, cleaning cloths, etc. (for screwing on), anthracite</p>									
R/L	▲	540	555	604	742	796	824	885	974	-
	▲	540	555	604	742	796	824	885	974	-
	▲	540	555	604	793	838	867	926	1019	-
	▲	577	596	650	887	944	977	1048	1153	-
	<p><b>Optional accessories</b>                      HW HS Holder for vacuum cleaner hose or PET storage pocket (for screwing on), anthracite                      HW UTB Utensils box, e.g. for storing towels, cleaning cloths, etc. (for screwing on), anthracite</p>									
R/L	▲	620	635	685	825	878	903	966	1063	-
	▲	620	635	685	825	878	903	966	1063	-
	▲	620	635	685	875	920	949	1009	1110	-
	▲	658	675	730	969	1025	1058	1131	1244	-
	<p><b>Not available for:</b>                      ALUELEMENTS, ATLANTA-B, ATLANTA-S, BERGEN, CASTELLO, CHALET-B, CHALET-S, CHICAGO, FRAME, LUGANO, LUX-B, MIAMI, MODENA, MUNICH, NEVADA, NOBEL-B, NOBEL-S, ORLANDO-B, ORLANDO-S, OSLO 15, PADUA, SOFIE-B, SOFIE-S, TESSIN 15, TIM 15, VINO, VIVA, YORK-B, YORK-S</p> <p>Each front has a tightening fitting                      Ranges without fitting: SMARTGLAS, NOBEL, SOFIE, YORK, LUGANO, TALEA, RIVA, GARDA, ATLANTA, ORLANDO, CHICAGO without tightening fitting</p> <p><b>Optional accessories</b>                      HW HS Holder for vacuum cleaner hose or PET storage pocket (for screwing on), anthracite                      HW UTB Utensils box, e.g. for storing towels, cleaning cloths, etc. (for screwing on), anthracite</p>									
R/L	■	990	1010	1057	1180	1233	1259	1323	1455	-
	■	1031	1049	1096	1220	1274	1299	1361	1497	-
	■	1031	1049	1096	1220	1274	1299	1361	1497	-
	■	1046	1065	1113	1284	1332	1358	1418	1560	-
	■	1105	1126	1177	1399	1456	1490	1560	1716	-
<p><b>Planning advice:</b>                      Doors with wide angle hinges may not be planned alongside units or panels if the protrusion to the front of the adjoining article is greater than 3 cm (hinge side).                      Doors with wide angle hinges protrude over the carcass side.</p>										
R/L	■	1001	1018	1066	1188	1243	1270	1333	1466	-
	■	1038	1057	1105	1226	1280	1307	1370	1507	-
	■	1038	1057	1105	1226	1280	1307	1370	1507	-
	■	1055	1072	1120	1292	1339	1365	1428	1571	-
	■	1114	1133	1187	1409	1464	1499	1569	1726	-
<p><b>Planning advice:</b>                      Doors with wide angle hinges may not be planned alongside units or panels if the protrusion to the front of the adjoining article is greater than 3 cm (hinge side).                      Doors with wide angle hinges protrude over the carcass side.</p>										



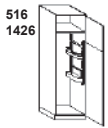
**Broom cupboard**  
 1 door 194.6 cm  
 1 fixed shelf  
 1 hook rail  
 1 storage basket



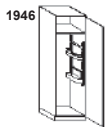
**Broom cupboard**  
 1 door 129.6 cm connected to 1 door 64.6 cm  
 1 fixed shelf  
 1 hook rail with 5 hooks, anthracite  
 Modular interior partitioning system, consisting of:  
 1 set of attachment rails, anthracite  
 1 large 3-side tray with rail, anthracite  
 1 carrier box for cleaning materials with carrier rails, anthracite  
 1 hook rail with 5 hooks, anthracite



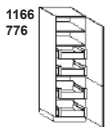
**Broom cupboard**  
 1 door 116.6 cm connected to 1 door 77.6 cm  
 1 fixed shelf  
 1 hook rail with 5 hooks, anthracite  
 Modular interior partitioning system, consisting of:  
 1 set of attachment rails, anthracite  
 1 large 3-side tray with rail, anthracite  
 1 carrier box for cleaning materials with carrier rails, anthracite  
 1 hook rail with 5 hooks, anthracite



**Broom cupboard**  
 1 door 51.6 cm connected to 1 door 142.6 cm  
 1 fixed shelf  
 1 hook rail with 5 hooks, anthracite  
 Modular interior partitioning system, consisting of:  
 1 set of attachment rails, anthracite  
 1 large 3-side tray with rail, anthracite  
 1 carrier box for cleaning materials with carrier rails, anthracite  
 1 hook rail with 5 hooks, anthracite



**Broom cupboard**  
 1 door 194.6 cm  
 1 fixed shelf  
 1 hook rail with 5 hooks, anthracite  
 Modular interior partitioning system, consisting of:  
 1 set of attachment rails, anthracite  
 1 large 3-side tray with rail, anthracite  
 1 carrier box for cleaning materials with carrier rails, anthracite  
 1 hook rail with 5 hooks, anthracite



**Larder unit**  
 1 door 116.6 cm with wide angle hinges  
 2 adjustable shelves  
 2 internal pull-outs  
 1 fixed shelf  
 1 door 77.6 cm with wide angle hinges  
 2 internal pull-outs



**Planning advice:**  
 Take account of opening angle



**Larder unit**  
 1 door 116.6 cm with wide angle hinges  
 2 adjustable shelves  
 3 internal drawers  
 1 fixed shelf  
 1 door 77.6 cm with wide angle hinges  
 2 internal pull-outs



**Planning advice:**  
 Take account of opening angle



# Tall units 194.8 cm high

Carcase depth 55.5 cm (standard)

- = Models also available in 34/45.5/61 cm carcass depth (Order no.: ... replace ... 55 ... with 34/45/61)
- = Models also available in 45.5/61 cm carcass depth (order no.: replace ... 55 ... with 45/61)
- ▲ = Types also available with 61 cm carcass depth (order no.: ... replace ... 55 ... with 61)

Order no.  
W H D

		Hinge side:	Carcass depth	Price groups																		
				1	2	3	4	5	6	7	8	9										
1101 841		R/L	■																			
													GGA 30 19 55 06	990	1010	1057	1180	1233	1259	1323	1455	-
													GGA 40 19 55 06	1031	1049	1096	1220	1274	1299	1361	1497	-
													GGA 45 19 55 06	1031	1049	1096	1220	1274	1299	1361	1497	-
													GGA 50 19 55 06	1046	1065	1113	1284	1332	1358	1418	1560	-
		R/L	■	GGA 60 19 55 06	1105	1126	1177	1399	1456	1490	1560	1716	-									
		Not available for: MIAMI, VIVA																				
		Planning advice: Doors with wide angle hinges may not be planned alongside units or panels if the protrusion to the front of the adjoining article is greater than 3 cm (hinge side). Doors with wide angle hinges protrude over the carcass side.																				
1946		R/L	■																			
													GGA 30 19 55 71	1072	1090	1137	1260	1315	1341	1403	1543	-
													GGA 40 19 55 71	1072	1090	1137	1260	1315	1341	1403	1543	-
													GGA 45 19 55 71	1112	1131	1178	1300	1355	1382	1443	1587	-
													GGA 50 19 55 71	1129	1145	1195	1365	1412	1439	1501	1651	-
		R/L	■	GGA 60 19 55 71	1185	1205	1257	1481	1537	1570	1642	1806	-									
		Not available for: ALUELEMENTS, ATLANTA-B, ATLANTA-S, BERGEN, CASTELLO, CHALET-B, CHALET-S, CHICAGO, FRAME, LUGANO, LUX-B, MIAMI, MODENA, MUNICH, NEVADA, NOBEL-B, NOBEL-S, ORLANDO-B, ORLANDO-S, OSLO 15, PADUA, SOFIE-B, SOFIE-S, TESSIN 15, TIM 15, VINO, VIVA, YORK-B, YORK-S																				
		Planning advice: Each front has a tightening fitting Ranges without fitting: SMARTGLAS, NOBEL, SOFIE, YORK, LUGANO, TALEA, RIVA, GARDA, ATLANTA, ORLANDO, CHICAGO without tightening fitting Doors with wide angle hinges may not be planned alongside units or panels if the protrusion to the front of the adjoining article is greater than 3 cm (hinge side). Doors with wide angle hinges protrude over the carcass side.																				
1946		R/L	■																			
													GGA 30 19 55 72	1080	1098	1147	1270	1324	1349	1413	1554	-
													GGA 40 19 55 72	1080	1098	1147	1270	1324	1349	1413	1554	-
													GGA 45 19 55 72	1118	1137	1185	1309	1361	1389	1452	1597	-
													GGA 50 19 55 72	1135	1152	1201	1374	1418	1448	1507	1658	-
		R/L	■	GGA 60 19 55 72	1196	1214	1269	1490	1547	1578	1649	1814	-									
		Not available for: ALUELEMENTS, ATLANTA-B, ATLANTA-S, BERGEN, CASTELLO, CHALET-B, CHALET-S, CHICAGO, FRAME, LUGANO, LUX-B, MIAMI, MODENA, MUNICH, NEVADA, NOBEL-B, NOBEL-S, ORLANDO-B, ORLANDO-S, OSLO 15, PADUA, SOFIE-B, SOFIE-S, TESSIN 15, TIM 15, VINO, VIVA, YORK-B, YORK-S																				
		Planning advice: Each front has a tightening fitting Ranges without fitting: SMARTGLAS, NOBEL, SOFIE, YORK, LUGANO, TALEA, RIVA, GARDA, ATLANTA, ORLANDO, CHICAGO without tightening fitting Doors with wide angle hinges may not be planned alongside units or panels if the protrusion to the front of the adjoining article is greater than 3 cm (hinge side). Doors with wide angle hinges protrude over the carcass side.																				
1166 776		■																				
												GGA 90 19 55 03	1639	1675	1769	2026	2134	2185	2312	2543	-	
		Planning advice: Take account of opening angle																				
1166 386 386		■																				
												GGA 90 19 55 02	1386	1435	1639	1871	1951	2059	2267	2494	-	
		■	GGA 100 19 55 02	1386	1435	1639	1871	1951	2059	2267	2494	-										
		Planning advice: Take account of opening angle																				
1946		R/L	■																			
													GK 45 19 61 70	688	712	735	862	952	1004	1078	1184	-
													GK 50 19 61 70	699	724	746	873	964	1015	1089	1196	-
		R/L	■	GK 60 19 61 70	711	735	758	884	976	1027	1101	1209	-									
		Not available for: ALUELEMENTS, ATLANTA-B, ATLANTA-S, BERGEN, CASTELLO, CHALET-B, CHALET-S, CHICAGO, FRAME, LUGANO, LUX-B, MIAMI, MODENA, MUNICH, NEVADA, NOBEL-B, NOBEL-S, ORLANDO-B, ORLANDO-S, OSLO 15, PADUA, SOFIE-B, SOFIE-S, TESSIN 15, TIM 15, VINO, VIVA, YORK-B, YORK-S																				
		Planning advice: Each front has a tightening fitting Ranges without fitting: SMARTGLAS, NOBEL, SOFIE, YORK, LUGANO, TALEA, RIVA, GARDA, ATLANTA, ORLANDO, CHICAGO without tightening fitting																				
1946		R/L	■																			
													GK 90 19 61 70	1359	1408	1454	1707	1887	1991	2139	2350	-
													GK 100 19 61 70	1382	1430	1477	1729	1911	2015	2161	2374	-
		Not available for: ALUELEMENTS, ATLANTA-B, ATLANTA-S, BERGEN, CASTELLO, CHALET-B, CHALET-S, CHICAGO, FRAME, LUGANO, LUX-B, MIAMI, MODENA, MUNICH, NEVADA, NOBEL-B, NOBEL-S, ORLANDO-B, ORLANDO-S, OSLO 15, PADUA, SOFIE-B, SOFIE-S, TESSIN 15, TIM 15, VINO, VIVA, YORK-B, YORK-S																				
		Planning advice: Each front has a tightening fitting Ranges without fitting: SMARTGLAS, NOBEL, SOFIE, YORK, LUGANO, TALEA, RIVA, GARDA, ATLANTA, ORLANDO, CHICAGO without tightening fitting																				

84,5

N

N

78

78

61,0

61,0

Planning advice:  
Take account of opening angle

Planning advice:  
Take account of opening angle

Planning advice:  
Take account of opening angle

Planning advice:  
Take account of opening angle

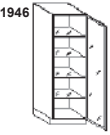
Carcass depth 61 cm  
Usable inside depth 58.5 cm

Carcass depth 61 cm  
Usable inside depth 58.5 cm

# Tall units 194.8 cm high with glass fronts

Carcase depth 55.5 cm (standard)

■ = Models also available in 34/45.5/61 cm carcass depth (Order no.: ... replace ... 55 ... with 34/45/61)



**Crockery cupboard with glass front**  
 -neutral-  
 1 glass door 194.6 cm  
 4 adjustable glass shelves  
 and 1 additional adjustable glass shelf  
 for individual positioning

34,0  
45,5  
55,5  
61,0

Order no.  
W H D

GGGD 45 19 55 70  
 GGGD 50 19 55 70  
 GGGD 60 19 55 70

Glass groups					
G1	G2	G2S	G5S	G6	
R/L ■	-	-	1057	1236	1441
R/L ■	-	-	1078	1260	1462
R/L ■	-	-	1103	1290	1487

G 1	G 2	G 2S
G1 AKTIVglass frame	G2 Design front	G2S aluminium, framed glass door
G 5	G 5S	G 6
	G5S aluminium, door with mullion	G6 NEW SALON

## Additional equipment

**Surcharge for tall cabinets with glass fronts inside and exterior in the same design**  
 available in decor groups:  
 S/B/H/MP/F/Z

Order no.  
W H D

IDF-G

Decor groups									
M10	M20	M30	M40	M50	M60	M70	M80	M90	
-	-	-	-	1646	-	1646	1646	-	

M 10	M 20	M 30	M 40	M 50
K M10 laminate				B M50 Velvet lacquer S M50 microstructure lacquer
M 60	M 70	M 80	M 90	
	F M70 veneer / oak / walnut Z M70 Veneer / Bavaria	H M80 high gloss-Lacquer MP M80 laqué mat Premium		

## Tall units 194.8 cm high with roller shutter

The useable inside depth (bare dimension) for the following carcass depths is  
 36.1 cm – bare dimension 26.5 cm / 47.7 cm – bare dimension 38.1 cm  
 57.7 cm – bare dimension 48.1 cm / 63.2 cm – bare dimension 53.6 cm  
 ▲ = Types also available with 63.2 cm carcass depth (order no. ... replace ... 58 ... with 63)

Order no.  
W H D

GJG 60 19 58 77

Decor groups									
M10	M20	M30	M40	M50	M60	M70	M80	M90	
▲	1684	-	-	-	3872	-	4573	-	-

optional accessory:  
 only TAB-A\*\*45 can be used as a pull-out shelf, and only 577 mm deep  
 No visible sides possible in other decor groups

GJG 60 19 48 77

	1644	-	-	-	3585	-	4190	-	-
--	------	---	---	---	------	---	------	---	---

No visible sides possible in other decor groups

GJG 60 19 58 78

▲	1803	-	-	-	3991	-	4692	-	-
---	------	---	---	---	------	---	------	---	---

optional accessory:  
 only TAB-A\*\*45 can be used as a pull-out shelf, and only 577 mm deep  
 No visible sides possible in other decor groups

GJG 60 19 48 78

	1762	-	-	-	3703	-	4309	-	-
--	------	---	---	---	------	---	------	---	---

No visible sides possible in other decor groups

GJS GG 60 19 58

▲	3442	-	-	-	5630	-	6330	-	-
---	------	---	---	---	------	---	------	---	---

Panel, guide profile and handle in the same colour as the roller shutter  
 optional accessory:  
 only TAB-A\*\*45 can be used as a pull-out shelf, and only 577 mm deep  
 No visible sides possible in other decor groups

GJS GG 60 19 48

	3400	-	-	-	5341	-	5948	-	-
--	------	---	---	---	------	---	------	---	---

M 10	M 20	M 30	M 40	M 50
K M10 laminate				B M50 Velvet Lacquer S Microstructur lacquer
M 60	M 70	M 80	M 90	
	F M70 veneer / oak / walnut Z M70 Veneer / Bavaria			



# Tall units 194.8 cm high with roller shutter

The useable inside depth (bare dimension) for the following carcass depths is  
 36.1 cm – bare dimension 26.5 cm / 47.7 cm – bare dimension 38.1 cm  
 57.7 cm – bare dimension 48.1 cm / 63.2 cm – bare dimension 53.6 cm  
 ▲ = Types also available with 63.2 cm carcass depth (order no. ... replace ... 58 ... with 63)

Order no.  
W H D

Hinge side:	Carcass depth	Decor groups								
		M10	M20	M30	M40	M50	M60	M70	M80	M90



**Pull-out shelf with guide rails**  
 With locking function, full pull-out „push to open“, shelf from decor group K  
 For carcass width 45 cm, 50 cm, 60 cm  
 For carcass width 80 cm, 90 cm  
 for carcass depths 45.5 cm and 55.5 cm

- Load-bearing capacity depth 55.5 cm: 35 kg
- Load-bearing capacity depth 45.5 cm: 35 kg
- Load-bearing capacity depth 55.5 cm: 35 kg
- Load-bearing capacity depth 45.5 cm: 35 kg
- Load-bearing capacity depth 55.5 cm: 35 kg
- Load-bearing capacity depth 45.5 cm: 35 kg
- Load-bearing capacity depth 55.5 cm: 30 kg
- Load-bearing capacity depth 45.5 cm: 30 kg
- Load-bearing capacity depth 55.5 cm: 30 kg
- Load-bearing capacity depth 45.5 cm: 30 kg



**Important:**  
 When installing in units with hinged doors always take wide angle hinges SA-9015E3 into consideration.

TAB-AZ45 55	220	-	-	-	-	-	-	-	-	-
TAB-AZ45 45	220	-	-	-	-	-	-	-	-	-
TAB-AZ50 55	225	-	-	-	-	-	-	-	-	-
TAB-AZ50 45	225	-	-	-	-	-	-	-	-	-
TAB-AZ60 55	234	-	-	-	-	-	-	-	-	-
TAB-AZ60 45	234	-	-	-	-	-	-	-	-	-
TAB-AZ80 55	282	-	-	-	-	-	-	-	-	-
TAB-AZ80 45	282	-	-	-	-	-	-	-	-	-
TAB-AZ90 55	298	-	-	-	-	-	-	-	-	-
TAB-AZ90 45	298	-	-	-	-	-	-	-	-	-

## Appliance unit 194.8 cm high for microwave / oven

Carcass depth 55.5 cm (standard)

▲ = Types also available with 61 cm carcass depth (order no. ... replace ... 55 ... with 61)

Order no.  
W H D

Hinge side:	Carcass depth	Price groups								
		1	2	3	4	5	6	7	8	9

646 776 **Appliance unit**  
 1 door 64.6 cm  
 2 adjustable shelves  
 1 panel  
 1 appliance aperture 36.2 - 50 cm  
 1 door 77.6 cm  
 2 adjustable shelves

36.2-50.0	GO	60	19	55	10	1	R/L	▲	419	438	493	584	623	655	717	789	-
78	GO	60	19	55	10	1A	R/L	▲	419	438	493	584	623	655	717	789	-

646 776 **Appliance unit**  
 1 door 64.6 cm  
 2 adjustable shelves  
 1 panel  
 1 appliance aperture 36.2 - 50 cm  
 1 door 77.6 cm with wide angle hinges  
 3 internal drawers

36.2-50.0	GO	60	19	55	10	4	R/L	▲	772	791	847	938	976	1009	1070	1177	-
78	GO	60	19	55	10	4A	R/L	▲	772	791	847	938	976	1009	1070	1177	-

646 386 386 **Appliance unit**  
 1 door 64.6 cm  
 2 adjustable shelves  
 1 panel  
 1 appliance aperture 36.2 - 50 cm  
 2 pull-outs 38.6 cm

36.2-50.0	GO	60	19	55	10	X4	R/L	▲	809	826	883	974	1011	1045	1106	1217	-
78	GO	60	19	55	10	X4A	R/L	▲	809	826	883	974	1011	1045	1106	1217	-

646 126 256 386 **Appliance unit**  
 1 door 64.6 cm  
 2 adjustable shelves  
 1 panel  
 1 appliance aperture 36.2 - 50 cm  
 1 drawer 12.6 cm  
 1 pull-out 25.6 cm  
 1 pull-out 38.6 cm

36.2-50.0	GO	60	19	55	10	2	R/L	▲	896	913	970	1061	1098	1132	1193	1312	-
78	GO	60	19	55	10	2A	R/L	▲	896	913	970	1061	1098	1132	1193	1312	-

841 **Appliance unit with compensation door above appliance aperture**  
 1 appliance aperture 36.2 - 50 cm  
 1 door 84.1 cm  
 4 adjustable shelves


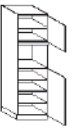







36.2-50.0	GO	60	19	55	10	8A	R/L	▲	419	438	493	584	623	655	717	789	-
84,5																	

**NEW**

# Appliance unit 194.8 cm high for microwave / oven

Carcase depth 55.5 cm (standard)



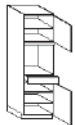









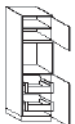



▲ = Types also available with 61 cm carcass depth (order no. ... replace ... 55 ... with 61)

		Order no.			Hinge side:	Carcass depth	Price groups													
		W	H	D			1	2	3	4	5	6	7	8	9					
516 126 776		<b>Appliance unit</b> 1 door 51.6 cm 1 panel 1 appliance aperture 37.3 - 50 cm 1 drawer 12.6 cm 1 door 77.6 cm 3 adjustable shelves	37,3-50,0	GO	60	19	55	10	5	R/L	▲	562	582	639	728	767	800	860	946	-
		<b>Appliance unit with compensation door above appliance aperture</b>		GO	60	19	55	10	5A	R/L	▲	562	582	639	728	767	800	860	946	-
516 906		<b>Appliance unit</b> 1 door 51.6 cm 1 panel 1 appliance aperture 37.3 - 50 cm 1 door 90.6 cm 4 adjustable shelves	37,3-50,0	GO	60	19	55	10		R/L	▲	419	438	493	584	623	655	717	789	-
		<b>Appliance unit with compensation door above appliance aperture</b>		GO	60	19	55	10	A	R/L	▲	419	438	493	584	623	655	717	789	-
386 451		<b>Appliance unit</b> 1 appliance aperture 37.3 - 50 cm 1 pull-out 38.6 cm 1 pull-out 45.1 cm 2 adjustable shelves	37,3-50,0	GO	60	19	55	10	X9A	R/L	▲	749	770	826	916	955	987	1047	1152	-
		<b>Appliance unit with compensation door above appliance aperture</b>		GO	60	19	55	10	X9A	R/L	▲	749	770	826	916	955	987	1047	1152	-
516 126 386 386		<b>Appliance unit</b> 1 door 51.6 cm 1 adjustable shelf 1 panel 1 appliance aperture 37.3 - 50 cm 1 drawer 12.6 cm 2 pull-outs 38.6 cm	37,3-50,0	GO	60	19	55	10	3	R/L	▲	898	916	972	1063	1101	1134	1195	1315	-
		<b>Appliance unit with compensation door above appliance aperture</b>		GO	60	19	55	10	3A	R/L	▲	898	916	972	1063	1101	1134	1195	1315	-
646 126 256 386		<b>Appliance unit</b> 2 doors 64.6 cm 2 adjustable shelves 1 panel 1 appliance aperture 46.0 - 48.0 cm 1 drawer 12.6 cm 1 pull-out 25.6 cm 1 pull-out 38.6 cm	46,0-48,0	GO	90	19	55	10	12		▲	1342	1392	1573	1829	1911	2017	2227	2450	-
		<b>Appliance unit with compensation door above appliance aperture</b>		GO	90	19	55	10	12A		▲	1342	1392	1573	1829	1911	2017	2227	2450	-
585 711		<b>Appliance unit</b> 1 door 58.5 cm 1 panel 1 appliance aperture 58.0 - 59.5 cm 1 door 71.1 cm 3 adjustable shelves	58,0-59,5	GO	60	19	55	20	9	R/L	▲	419	438	493	584	623	655	717	789	-
		<b>Appliance unit with compensation door above appliance aperture</b>	NEW	GO	60	19	55	20	9A	R/L	▲	419	438	493	584	623	655	717	789	-
516 776		<b>Appliance unit</b> 1 door 51.6 cm 1 panel 1 appliance aperture 58.0 - 59.5 cm 1 door 77.6 cm 3 adjustable shelves	58,0-59,5	GO	60	19	55	20	X	R/L	▲	419	438	493	584	623	655	717	789	-
		<b>Appliance unit with compensation door above appliance aperture</b>		GO	60	19	55	20	XA	R/L	▲	419	438	493	584	623	655	717	789	-
516 776		<b>Appliance unit</b> 1 door 51.6 cm 1 adjustable shelf 1 panel 1 appliance aperture 58.0 - 59.5 cm 1 door 77.6 cm 2 internal pull-outs	58,0-59,5	GO	60	19	55	20	X10	R/L	▲	775	794	849	940	979	1011	1073	1180	-
		<b>Appliance unit with compensation door above appliance aperture</b>	NEW	GO	60	19	55	20	X10A	R/L	▲	775	794	849	940	979	1011	1073	1180	-
516 776		<b>Appliance unit</b> 1 door 51.6 cm 1 adjustable shelf 1 panel 1 appliance aperture 58.0 - 59.5 cm 1 door 77.6 cm 1 internal drawer 2 internal pull-outs	58,0-59,5	GO	60	19	55	20	X11	R/L	▲	827	843	892	1029	1084	1111	1173	1290	-
		<b>Appliance unit with compensation door above appliance aperture</b>	NEW	GO	60	19	55	20	X11A	R/L	▲	827	843	892	1029	1084	1111	1173	1290	-



# Appliance unit 194.8 cm high for microwave / oven

Carcase depth 55.5 cm (standard)

		Order no.			Hinge side:	Carcase depth	Price groups								
		W	H	D			1	2	3	4	5	6	7	8	9
516 776	 <p><b>Appliance unit</b> 1 door 51.6 cm 1 adjustable shelf 1 panel 1 appliance aperture 58.0 - 59.5 cm 1 door 77.6 cm with wide angle hinges 3 internal drawers</p> <p> <b>Appliance unit with compensation door above appliance aperture</b></p>	58,0-59,5	GO	60 19 55 20 X7	R/L	▲	772	791	847	938	976	1009	1070	1177	-
		78	GO	60 19 55 20 X7A	R/L	▲	772	791	847	938	976	1009	1070	1177	-
516 126 646	 <p><b>Appliance unit</b> 1 door 51.6 cm 1 panel 1 appliance aperture 58.0 - 59.5 cm 1 drawer 12.6 cm 1 door 64.6 cm 3 adjustable shelves</p> <p> <b>Appliance unit with compensation door above appliance aperture</b></p>	58,0-59,5	GO	60 19 55 20 X5	R/L	▲	562	582	639	728	767	800	860	946	-
		78	GO	60 19 55 20 X5A	R/L	▲	562	582	639	728	767	800	860	946	-
516 386	 <p><b>Appliance unit</b> 1 door 51.6 cm 1 adjustable shelf 1 panel 1 appliance aperture 58.0 - 59.5 cm 2 pull-outs 38.6 cm</p> <p> <b>Appliance unit with compensation door above appliance aperture</b></p>	58,0-59,5	GO	60 19 55 20 X4	R/L	▲	749	770	826	916	955	987	1047	1152	-
		78	GO	60 19 55 20 X4A	R/L	▲	749	770	826	916	955	987	1047	1152	-
516 256	 <p><b>Appliance unit</b> 1 door 51.6 cm 1 panel 1 appliance aperture 58.0 - 59.5 cm 3 pull-outs 25.6 cm 1 adjustable shelf</p> <p> <b>Appliance unit with compensation door above appliance aperture</b></p>	58,0-59,5	GO	60 19 55 20 X6	R/L	▲	940	958	1014	1106	1143	1177	1236	1360	-
		78	GO	60 19 55 20 X6A	R/L	▲	940	958	1014	1106	1143	1177	1236	1360	-
516 126 386	 <p><b>Appliance unit</b> 1 door 51.6 cm 1 panel 1 appliance aperture 58.0 - 59.5 cm 1 drawer 12.6 cm 1 pull-out 25.6 cm 1 pull-out 38.6 cm 1 adjustable shelf</p> <p> <b>Appliance unit with compensation door above appliance aperture</b></p>	58,0-59,5	GO	60 19 55 20 X3	R/L	▲	896	911	969	1049	1088	1118	1180	1298	-
		78	GO	60 19 55 20 X3A	R/L	▲	896	911	969	1049	1088	1118	1180	1298	-
451 841	 <p><b>Appliance unit</b> 1 door 45.1 cm 1 panel 1 appliance aperture 58.0 - 59.5 cm 1 door 84.1 cm 3 adjustable shelves</p> <p> <b>Appliance unit with compensation door above appliance aperture</b></p>	58,0-59,5	GO	60 19 55 20 8	R/L	▲	419	438	493	584	623	655	717	789	-
		84,5	NEW	GO	60 19 55 20 8A	R/L	▲	419	438	493	584	623	655	717	789
451 841	 <p><b>Appliance unit</b> 1 door 45.1 cm 1 adjustable shelf 1 panel 1 appliance aperture 58.0 - 59.5 cm 1 door 84.1 cm 2 internal pull-outs</p> <p> <b>Appliance unit with compensation door above appliance aperture</b></p>	58,0-59,5	GO	60 19 55 20 X12	R/L	▲	775	794	849	940	979	1011	1073	1145	-
		84,5	NEW	GO	60 19 55 20 X12A	R/L	▲	775	794	849	940	979	1011	1073	1145
451 841	 <p><b>Appliance unit</b> 1 door 45.1 cm 1 adjustable shelf 1 panel 1 appliance aperture 58.0 - 59.5 cm 1 door 84.1 cm 1 internal drawer 2 internal pull-outs</p> <p> <b>Appliance unit with compensation door above appliance aperture</b></p>	58,0-59,5	GO	60 19 55 20 X13	R/L	▲	893	912	967	1058	1097	1129	1191	1263	-
		84,5	NEW	GO	60 19 55 20 X13A	R/L	▲	893	912	967	1058	1097	1129	1191	1263



Models not available with compensation door: MIAMI, VIVA

# Appliance unit 194.8 cm high for microwave / oven

Carcase depth 55.5 cm (standard)

▲ = Types also available with 61 cm carcass depth (order no. ... replace ... 55 ... with 61)

Order no.	W	H	D	Hinge side:	Carcass depth	Price groups														
						1	2	3	4	5	6	7	8	9						
386 451		<b>Appliance unit</b>		R/L ▲	58,0-59,5	GO	60	19	55	20	X9A	749	770	826	916	955	987	1047	1152	-
		1 appliance aperture 58.0 - 59.5 cm 1 pull-out 38.6 cm 1 pull-out 45.1 cm 1 adjustable shelf																		
451 126 256 451		<b>Appliance unit</b>		R/L ▲	58,0-59,5	GO	60	19	55	20	X8	896	911	969	1049	1088	1118	1180	1298	-
		1 door 45.1 cm 1 panel 1 appliance aperture 58.0 - 59.5 cm 1 drawer 12.6 cm 1 pull-out 25.6 cm 1 pull-out 45.1 cm																		
		<b>Appliance unit with compensation door above appliance aperture</b>		R/L ▲		GO	60	19	55	20	X8A	896	911	969	1049	1088	1118	1180	1298	-

# Appliance unit 194.8 cm high for microwave / oven Double aperture

Carcass depth 55.5 cm (standard)


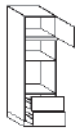
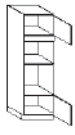

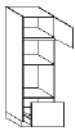
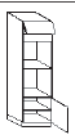
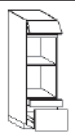
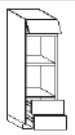
▲ = Types also available with 61 cm carcass depth (order no. ... replace ... 55 ... with 61)

386 516		<b>Appliance unit</b>		R/L ▲	45,0	GO	60	19	55	09	B	445	465	519	612	650	684	742	816	-
		1 door 38.6 cm 1 panel 1 appliance aperture 45.0 cm 1 appliance aperture 45.0 cm 1 door 51.6 cm 1 adjustable shelf																		
		<b>Appliance unit with compensation door above appliance aperture</b>		R/L ▲		GO	60	19	55	09	BA	445	465	519	612	650	684	742	816	-
386 126 386		<b>Appliance unit</b>		R/L ▲	45,0	GO	60	19	55	09	B2	711	728	785	869	908	939	1002	1102	-
		1 door 38.6 cm 1 panel 1 appliance aperture 45.0 cm 1 appliance aperture 45.0 cm 1 drawer 12.6 cm 1 pull-out 38.6 cm																		
		<b>Appliance unit with compensation door above appliance aperture</b>		R/L ▲		GO	60	19	55	09	B2A	711	728	785	869	908	939	1002	1102	-
516 386		<b>Appliance unit</b>		R/L ▲	30,8-40,9	GO	60	19	55	27	XA	419	438	493	584	623	655	717	789	-
		1 door 51.6 cm 1 panel 1 appliance aperture 30.8 - 40.9 cm 1 appliance aperture 58.0 - 59.5 cm 1 door 38.6 cm 1 adjustable shelf																		
		<b>Appliance unit with compensation door above appliance aperture</b>		R/L ▲	58,0-59,5	GO	60	19	55	27	XAA	419	438	493	584	623	655	717	789	-
516 386		<b>Appliance unit</b>		R/L ▲	30,8-40,9	GO	60	19	55	27	XA2	568	586	643	734	772	805	864	950	-
		1 door 51.6 cm 1 adjustable shelf 1 panel 1 appliance aperture 30.8 - 40.9 cm 1 appliance aperture 58.0 - 59.5 cm 1 pull-out 38.6 cm																		
		<b>Appliance unit with compensation door above appliance aperture</b>		R/L ▲	58,0-59,5	GO	60	19	55	27	XA2A	568	586	643	734	772	805	864	950	-
516 126 256		<b>Appliance unit</b>		R/L ▲	30,8-40,9	GO	60	19	55	27	XB5	711	728	785	869	908	939	1002	1102	-
		1 door 51.6 cm 1 panel 1 appliance aperture 30.8 - 40.9 cm 1 appliance aperture 58.0 - 59.5 cm 1 drawer 12.6 cm 1 pull-out 25.6 cm 1 adjustable shelf																		
		<b>Appliance unit with compensation door above appliance aperture</b>		R/L ▲	58,0-59,5	GO	60	19	55	27	XB5A	711	728	785	869	908	939	1002	1102	-
386 516		<b>Appliance unit</b>		R/L ▲	30,8-40,9	GO	60	19	55	27	XB	419	438	493	584	623	655	717	789	-
		1 door 38.6 cm 1 panel 1 appliance aperture 30.8 - 40.9 cm 1 appliance aperture 58.0 - 59.5 cm 1 door 51.6 cm 1 adjustable shelf																		
		<b>Appliance unit with compensation door above appliance aperture</b>		R/L ▲	58,0-59,5	GO	60	19	55	27	XBA	419	438	493	584	623	655	717	789	-



## Appliance unit 194.8 cm high for microwave / oven Double aperture


Carcase depth 55.5 cm (standard)

		Order no.			Hinge side:	Carcase depth	Price groups								
		W	H	D			1	2	3	4	5	6	7	8	9
386 126 386		<b>Appliance unit</b> 1 door 38.6 cm 1 panel 1 appliance aperture 30.8 - 40.9 cm 1 appliance aperture 58.0 - 59.5 cm 1 drawer 12.6 cm 1 pull-out 38.6 cm	30,8-40,9	<b>GO 60 19 55 27 XB2</b>	R/L	▲	711	728	785	869	908	939	1002	1102	-
		<b>Appliance unit with compensation door above appliance aperture</b>	58,0-59,5	<b>GO 60 19 55 27 XB2A</b>	R/L	▲	711	728	785	869	908	939	1002	1102	-
386 256 256		<b>Appliance unit</b> 1 door 38.6 cm 1 panel 1 appliance aperture 30.8 - 40.9 cm 1 appliance aperture 58.0 - 59.5 cm 2 pull-outs 25.6 cm	30,8-40,9	<b>GO 60 19 55 27 XB4</b>	R/L	▲	749	770	826	916	955	987	1047	1152	-
		<b>Appliance unit with compensation door above appliance aperture</b>	58,0-59,5	<b>GO 60 19 55 27 XB4A</b>	R/L	▲	749	770	826	916	955	987	1047	1152	-
386 386		<b>Appliance unit</b> 1 door 38.6 cm 1 panel 1 appliance aperture 41 - 50 cm 1 appliance aperture 58.0 - 59.5 cm 1 door 38.6 cm	41,0-50,0	<b>GO 60 19 55 28 XA</b>	R/L	▲	419	438	493	584	623	655	717	789	-
		<b>Appliance unit with compensation door above appliance aperture</b>	58,0-59,5	<b>GO 60 19 55 28 XAA</b>	R/L	▲	419	438	493	584	623	655	717	789	-
386 386		<b>Appliance unit</b> 1 door 38.6 cm 1 panel 1 appliance aperture 41 - 50 cm 1 appliance aperture 58.0 - 59.5 cm 1 pull-out 38.6 cm	41,0-50,0	<b>GO 60 19 55 28 XA2</b>	R/L	▲	568	586	643	734	772	805	864	950	-
		<b>Appliance unit with compensation door above appliance aperture</b>	58,0-59,5	<b>GO 60 19 55 28 XA2A</b>	R/L	▲	568	586	643	734	772	805	864	950	-
386 451		<b>Appliance unit</b> 1 door 38.6 cm 1 panel 1 appliance aperture 41 - 50 cm 1 appliance aperture 58.0 - 59.5 cm 1 pull-out 45.1 cm	41,0-50,0	<b>GO 60 19 55 28 XA4</b>	R/L	▲	568	586	643	734	772	805	864	950	-
		<b>Appliance unit with compensation door above appliance aperture</b>	58,0-59,5	<b>GO 60 19 55 28 XA4A</b>	R/L	▲	568	586	643	734	772	805	864	950	-
			NEW												
256 516		<b>Appliance unit</b> 1 flap door 25.6 cm 1 panel 1 appliance aperture 41 - 50 cm 1 appliance aperture 58.0 - 59.5 cm 1 door 51.6 cm 1 adjustable shelf	41,0-50,0	<b>GO 60 19 55 28 XB</b>	R/L	▲	419	438	493	584	623	655	717	789	-
			58,0-59,5												
256 126 386		<b>Appliance unit</b> 1 flap door 25.6 cm 1 panel 1 appliance aperture 41 - 50 cm 1 appliance aperture 58.0 - 59.5 cm 1 drawer 12.6 cm 1 pull-out 38.6 cm	41,0-50,0	<b>GO 60 19 55 28 XB2</b>		▲	711	728	785	869	908	939	1002	1102	-
			58,0-59,5												
256 256 256		<b>Appliance unit</b> 1 flap door 25.6 cm 1 panel 1 appliance aperture 41 - 50 cm 1 appliance aperture 58.0 - 59.5 cm 2 pull-outs 25.6 cm	41,0-50,0	<b>GO 60 19 55 28 XB4</b>		▲	749	770	826	916	955	987	1047	1152	-
			58,0-59,5												

## Appliance unit 194.8 cm high for microwave / oven Lifting door / aperture

Carcase depth 55.5 cm (standard)

▲ = Types also available with 61 cm carcass depth (order no. ... replace ... 55 ... with 61)

386 516 126 256		<b>Appliance unit</b> 1 door 38.6 cm 1 lifting door with front 51.6 cm 1 panel 1 appliance aperture 58.0 - 59.5 cm 1 drawer 12.6 cm 1 pull-out 25.6 cm	58,0-59,5	<b>GO 60 19 55 36 X6</b>	R/L	▲	848	863	921	1010	1046	1077	1141	1255	-
		<b>Appliance unit with compensation door above appliance aperture</b>		<b>GO 60 19 55 36 X6A</b>	R/L	▲	848	863	921	1010	1046	1077	1141	1255	-





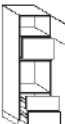

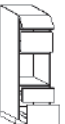



Models not available with compensation door: MIAMI, VIVA

# Appliance unit 194.8 cm high for microwave / oven Lifting door / aperture

Carcase depth 55.5 cm (standard)







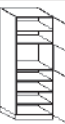

▲ = Types also available with 61 cm carcase depth (order no. ... replace ... 55 ... with 61)

		Order no.		Hinge side:		Price groups								
		W H D		Carcase depth		1	2	3	4	5	6	7	8	9
 <p><b>Appliance unit</b> 1 door 38.6 cm 1 lifting door with front 38.6 cm 1 panel 1 appliance aperture 58.0 - 59.5 cm 1 door 51.6 cm 1 adjustable shelf</p>	 <p><b>Appliance unit with compensation door above appliance aperture</b></p>	58,0-59,5	GO 60 19 55 29 X	R/L ▲	553	570	626	716	752	783	848	933	-	
		58,0-59,5	GO 60 19 55 29 XA	R/L ▲	553	570	626	716	752	783	848	933	-	
 <p><b>Appliance unit</b> 1 door 38.6 cm 1 lifting door with front 38.6 cm 1 panel 1 appliance aperture 58.0 - 59.5 cm 1 drawer 12.6 cm 1 pull-out 38.6 cm</p>	 <p><b>Appliance unit with compensation door above appliance aperture</b></p>	58,0-59,5	GO 60 19 55 29 X3	R/L ▲	848	863	921	1010	1046	1077	1141	1255	-	
		58,0-59,5	GO 60 19 55 29 X3A	R/L ▲	848	863	921	1010	1046	1077	1141	1255	-	
 <p><b>Appliance unit</b> 1 door 38.6 cm 1 lifting door with front 38.6 cm 1 panel 1 appliance aperture 58.0 - 59.5 cm 2 pull-outs 25.6 cm</p>	 <p><b>Appliance unit with compensation door above appliance aperture</b></p>	58,0-59,5	GO 60 19 55 29 X2	R/L ▲	885	902	958	1046	1084	1114	1179	1297	-	
		58,0-59,5	GO 60 19 55 29 X2A	R/L ▲	885	902	958	1046	1084	1114	1179	1297	-	
 <p><b>Appliance unit</b> 1 flap door 25.6 cm 1 lifting door with front 38.6 cm 1 panel 1 appliance aperture 58.0 - 59.5 cm 1 pull-out 25.6 cm 1 pull-out 38.6 cm</p>	 <p><b>Appliance unit with compensation door above appliance aperture</b></p>	58,0-59,5	GO 60 19 55 29 X5	R/L ▲	894	915	982	1070	1112	1143	1206	1327	-	
		58,0-59,5	GO 60 19 55 29 X5A	R/L ▲	894	915	982	1070	1112	1143	1206	1327	-	

# Appliance unit 194.8 cm high for microwave / oven 30 inches wide (76.2 cm)

Carcase depth 55.5 cm (standard)

▲ = Types also available with 61 cm carcase depth (order no. ... replace ... 55 ... with 61)

 <p><b>Appliance unit</b> 1 compensation door 3 adjustable shelves 1 appliance aperture 36.2 - 50 cm 1 door 77.6 cm 2 adjustable shelves</p>	 <p><b>Appliance unit with compensation door above appliance aperture</b></p>	76,2	GO 76 19 55 10 1A	R/L ▲	532	556	626	742	791	832	911	1002	-
		36,2-50,0	Not available for: ALUELEMENTS, FRAME, INTARSIA, MIAMI, STRIP ELEMENTS, VIVA										
 <p><b>Appliance unit</b> 1 compensation door 3 adjustable shelves 1 appliance aperture 36.2 - 50 cm 1 drawer 12.6 cm 1 pull-out 25.6 cm 1 pull-out 38.6 cm</p>	 <p><b>Appliance unit with compensation door above appliance aperture</b></p>	76,2	GO 76 19 55 10 2A	R/L ▲	1138	1160	1232	1347	1394	1438	1515	1667	-
		36,2-50,0	Not available for: ALUELEMENTS, FRAME, INTARSIA, MIAMI, STRIP ELEMENTS, VIVA										
 <p><b>Appliance unit</b> 1 compensation door 3 adjustable shelves 1 appliance aperture 36.2 - 50 cm 2 pull-outs 38.6 cm</p>	 <p><b>Appliance unit with compensation door above appliance aperture</b></p>	76,2	GO 76 19 55 10 X4A	R/L ▲	1027	1049	1121	1237	1284	1327	1405	1546	-
		36,2-50,0	Not available for: ALUELEMENTS, FRAME, INTARSIA, MIAMI, STRIP ELEMENTS, VIVA										
 <p><b>Appliance unit</b> 1 compensation door 2 adjustable shelves 1 appliance aperture 37.3 - 50 cm 1 door 90.6 cm 3 adjustable shelves</p>	 <p><b>Appliance unit with compensation door above appliance aperture</b></p>	76,2	GO 76 19 55 10 A	R/L ▲	532	556	626	742	791	832	911	1002	-
		37,3-50,0	Not available for: ALUELEMENTS, FRAME, INTARSIA, MIAMI, STRIP ELEMENTS, VIVA										

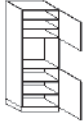

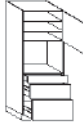

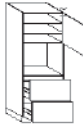

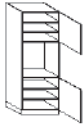

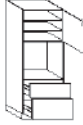



Models not available with compensation door: MIAMI, VIVA



# Appliance unit 194.8 cm high for microwave / oven 30 inches wide (76.2 cm)









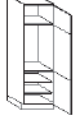

Carcase depth 55.5 cm (standard)

		Order no.		Hinge side:		Price groups										
		W H D		Carcase depth		1	2	3	4	5	6	7	8	9		
776	 <p><b>Appliance unit</b> 1 compensation door 3 adjustable shelves 1 appliance aperture 58.0 - 59.5 cm 1 door 77.6 cm 2 adjustable shelves</p>	76,2	GO 76 19 55 20 XA	R/L	▲	532	556	626	742	791	832	911	1002	-		
		58,0-59,5	 <b>Not available for:</b> ALUELEMENTS, FRAME, INTARSIA, MIAMI, STRIP ELEMENTS, VIVA													
		78														
126 256 386	 <p><b>Appliance unit</b> 1 compensation door 3 adjustable shelves 1 appliance aperture 58.0 - 59.5 cm 1 drawer 12.6 cm 1 pull-out 25.6 cm 1 pull-out 38.6 cm</p>	76,2	GO 76 19 55 20 X3A	R/L	▲	1138	1157	1231	1332	1382	1420	1499	1649	-		
		58,0-59,5	 <b>Not available for:</b> ALUELEMENTS, FRAME, INTARSIA, MIAMI, STRIP ELEMENTS, VIVA													
		78														
386 386	 <p><b>Appliance unit</b> 1 compensation door 2 adjustable shelves 1 appliance aperture 58.0 - 59.5 cm 2 pull-outs 38.6 cm</p>	76,2	GO 76 19 55 20 X4A	R/L	▲	951	978	1049	1163	1213	1253	1330	1463	-		
		58,0-59,5	 <b>Not available for:</b> ALUELEMENTS, FRAME, INTARSIA, MIAMI, STRIP ELEMENTS, VIVA													
		78														
646	 <p><b>Appliance unit</b> 1 compensation door 2 adjustable shelves 1 appliance aperture 66.0 - 71.8 cm 1 door 64.6 cm 2 adjustable shelves</p>	76,2	GO 76 19 55 19 XA	R/L	▲	532	556	626	742	791	832	911	1002	-		
		66,0-71,8	 <b>Not available for:</b> ALUELEMENTS, FRAME, INTARSIA, MIAMI, STRIP ELEMENTS, VIVA													
		78														
256 386	 <p><b>Appliance unit</b> 1 compensation door 2 adjustable shelves 1 appliance aperture 66.0 - 71.8 cm 1 pull-out 25.6 cm 1 pull-out 38.6 cm</p>	76,2	GO 76 19 55 19 X4A	R/L	▲	951	978	1049	1163	1213	1253	1330	1463	-		
		66,0-71,8	 <b>Not available for:</b> ALUELEMENTS, FRAME, INTARSIA, MIAMI, STRIP ELEMENTS, VIVA													
		78														

# Appliance unit 194.8 cm high for refrigerator/freezer

Carcase depth 55.5 cm (standard)

▲ = Types also available with 61 cm carcase depth (order no. ... replace ... 55 ... with 61) Integrated ventilation not possible with appliances with motor in the plinth (Cool Concept)

516 906	 <p><b>Appliance unit</b> 1 door 51.6 cm 1 panel 1 appliance aperture 37.3 - 50 cm 1 integrated appliance aperture 88 cm 1 door 90.6 cm 1 adjustable shelf</p> <p> <b>Appliance unit with compensation door above appliance aperture</b></p>	37,3-50,0	GOI 60 19 55 11 X	R/L	▲	419	438	493	584	623	655	717	789	-		
		88,0	 <b>Note:</b> Structural metal shelf at bottom Important: Observe the appliance manufacturers' permitted front weights for fixed door assembly. See overview of models for front weights.													
		78	GOI 60 19 55 11 XA	R/L	▲	419	438	493	584	623	655	717	789	-		
386 906	 <p><b>Appliance unit</b> 1 door 38.6 cm 1 panel 1 appliance aperture 58.0 - 59.5 cm 1 integrated appliance aperture 88 cm 1 door 90.6 cm</p> <p> <b>Appliance unit with compensation door above appliance aperture</b></p>	58,0-59,5	GOI 60 19 55 21 X	R/L	▲	419	438	493	584	623	655	717	789	-		
		88,0	 <b>Note:</b> Structural metal shelf at bottom Important: Observe the appliance manufacturers' permitted front weights for fixed door assembly. See overview of models for front weights.													
		78	GOI 60 19 55 21 XA	R/L	▲	419	438	493	584	623	655	717	789	-		
646 386 906	 <p><b>Appliance unit</b> 1 door 64.6 cm 1 lifting door with front 38.6 cm 1 integrated appliance aperture 88 cm 1 door 90.6 cm 2 adjustable shelves</p>	88,0	GI 60 19 55 35 X	R/L	▲	553	570	626	716	752	783	848	933	-		
		78	 <b>Important:</b> Observe the appliance manufacturers' permitted front weights for fixed door assembly. See overview of models for front weights.													
		78														
386 906 646	 <p><b>Appliance unit</b> 1 door 38.6 cm 1 integrated appliance aperture 88 cm 1 door 90.6 cm 1 door 64.6 cm 2 adjustable shelves</p>	88,0	GI 60 19 55 30 X	R/L	▲	441	460	533	675	767	812	890	979	-		
		78	 <b>Important:</b> Observe the appliance manufacturers' permitted front weights for fixed door assembly. See overview of models for front weights.													
		78														



Models not available with compensation door: MIAMI, VIVA













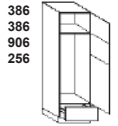
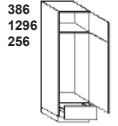
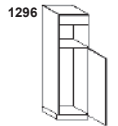
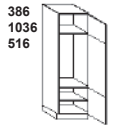
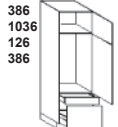
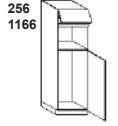
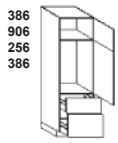
# Appliance unit 194.8 cm high for refrigerator/freezer

Carcase depth 55.5 cm (standard)

▲ = Types also available with 61 cm carcass depth (order no. ... replace ... 55 ... with 61)  
Integrated ventilation not possible with appliances with motor in the plinth (Cool Concept)

Order no.  
W H D

Hinge side:	Carcass depth	Price groups									
		1	2	3	4	5	6	7	8	9	
R/L ▲	88,0	<b>GI 60 19 55 30 X2</b>	773	792	865	1001	1091	1136	1217	1339	-
	 Important: Observe the appliance manufacturers' permitted front weights for fixed door assembly. See overview of models for front weights.										
R/L ▲		<b>GIB 60 19 55 30 X2</b>	789	808	881	1017	1107	1152	1232	1355	-
R/L ▲	36,0-45,0	<b>GOI 60 19 55 12 X4A</b>	441	460	533	675	767	812	890	979	-
	102,5	 Important: Observe the appliance manufacturers' permitted front weights for fixed door assembly. See overview of models for front weights.									
R/L ▲	37,3-45,0	<b>GOI 60 19 55 12 X1</b>	513	531	605	744	838	883	961	1057	-
	102,3	 Note: Structural metal shelf at bottom Important: Observe the appliance manufacturers' permitted front weights for fixed door assembly. See overview of models for front weights.									
R/L ▲		<b>GOI 60 19 55 12 X1A</b>	513	531	605	744	838	883	961	1057	-
R/L ▲	58,0-59,5	<b>GOI 60 19 55 12 X2</b>	513	531	605	744	838	883	961	1057	-
	102,3	 Note: Structural metal shelf at bottom Important: Observe the appliance manufacturers' permitted front weights for fixed door assembly. See overview of models for front weights.									
R/L ▲	37,3-50,0	<b>GOI 60 19 55 12 X</b>	441	460	533	675	767	812	890	979	-
	103,0	 Important: Observe the appliance manufacturers' permitted front weights for fixed door assembly. See overview of models for front weights.									
R/L ▲		<b>GOIB 60 19 55 12 X</b>	458	477	549	691	783	829	906	997	-
R/L ▲	103,0	<b>GI 60 19 55 40 X2</b>	732	750	825	961	1050	1097	1177	1295	-
	 Important: Observe the appliance manufacturers' permitted front weights for fixed door assembly. See overview of models for front weights.										
R/L ▲		<b>GIB 60 19 55 40 X2</b>	747	766	840	976	1066	1113	1193	1312	-
R/L ▲	103,0	<b>GI 60 19 55 40 X</b>	441	460	533	675	767	812	890	979	-
	 Important: Observe the appliance manufacturers' permitted front weights for fixed door assembly. See overview of models for front weights.										
R/L ▲		<b>GIB 60 19 55 40 X</b>	458	477	549	691	783	829	906	997	-
R/L ▲	37,3-50,0	<b>GOI 60 19 55 13 X</b>	441	460	533	675	767	812	890	979	-
	122,5	 Important: Observe the appliance manufacturers' permitted front weights for fixed door assembly. See overview of models for front weights.									
R/L ▲	122,5	<b>GI 60 19 55 50 X</b>	524	546	621	815	876	924	1011	1112	-
	 Important: Observe the appliance manufacturers' permitted front weights for fixed door assembly. See overview of models for front weights.										
R/L ▲		<b>GIB 60 19 55 50 X</b>	540	562	638	832	893	941	1027	1130	-
R/L ▲	122,5	<b>GI 60 19 55 55 01</b>	548	570	643	843	903	949	1037	1141	-
	 Important: Observe the appliance manufacturers' permitted front weights for fixed door assembly. See overview of models for front weights.										



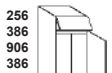
# Appliance unit 194.8 cm high for refrigerator/freezer

Carcase depth 55.5 cm (standard)

▲ = Types also available with 61 cm carcass depth (order no. ... replace ... 55 ... with 61)  
 Integrated ventilation not possible with appliances with motor in the plinth (Cool Concept)

Order no.  
 W H D

Hinge side: Carcass depth	Price groups														
	1	2	3	4	5	6	7	8	9						
R/L ▲	GI	60	19	55	50	X4	601	623	699	894	956	1004	1090	1199	-
	Important: Observe the appliance manufacturers' permitted front weights for fixed door assembly. See overview of models for front weights.														
R/L ▲	GIB	60	19	55	50	X4	617	639	714	909	972	1020	1106	1217	-
R/L ▲	GI	60	19	55	62	X14	565	587	663	858	920	968	1054	1159	-
	Important: Observe the appliance manufacturers' permitted front weights for fixed door assembly. See overview of models for front weights.														
R/L ▲	GIB	60	19	55	62	X14	581	603	677	873	935	983	1068	1175	-
R/L ▲	GI	60	19	55	51	X11	441	460	533	675	767	812	890	979	-
	Important: Observe the appliance manufacturers' permitted front weights for fixed door assembly. See overview of models for front weights.														
R/L ▲	GIB	60	19	55	51	X11	441	460	533	675	767	812	890	979	-
R/L ▲	GI	60	19	55	62	01	441	460	533	675	767	812	890	979	-
	Important: Observe the appliance manufacturers' permitted front weights for fixed door assembly. See overview of models for front weights.														
R/L ▲	GIB	60	19	55	62	01	458	477	549	691	783	829	906	997	-
R/L ▲	GI	60	19	55	62	X8	441	460	533	675	767	812	890	979	-
	Important: Observe the appliance manufacturers' permitted front weights for fixed door assembly. See overview of models for front weights.														
R/L ▲	GIB	60	19	55	62	X8	441	460	533	675	767	812	890	979	-
R/L ▲	GI	60	19	55	62	012	548	570	643	843	903	949	1037	1141	-
	Important: Observe the appliance manufacturers' permitted front weights for fixed door assembly. See overview of models for front weights.														
R/L ▲	GIB	60	19	55	62	012	548	570	643	843	903	949	1037	1141	-
R/L ▲	GI	60	19	55	68	X2	441	460	533	675	767	812	890	979	-
	Important: Observe the appliance manufacturers' permitted front weights for fixed door assembly. See overview of models for front weights.														
R/L ▲	GIB	60	19	55	68	X2	441	460	533	675	767	812	890	979	-
R/L ▲	GI	60	19	55	68	03	441	460	533	675	767	812	890	979	-
	Important: Observe the appliance manufacturers' permitted front weights for fixed door assembly. See overview of models for front weights.														
R/L ▲	GIB	60	19	55	68	03	441	460	533	675	767	812	890	979	-
R/L ▲	GI	60	19	55	79	02A	441	460	533	675	767	812	890	979	-
	Important: Observe the appliance manufacturers' permitted front weights for fixed door assembly. See overview of models for front weights.														
R/L ▲	GIB	60	19	55	79	02A	441	460	533	675	767	812	890	979	-
R/L ▲	GI	60	19	55	92	41	441	460	533	675	767	812	890	979	-
	Important: Observe the appliance manufacturers' permitted front weights for fixed door assembly. See overview of models for front weights.														
R/L ▲	GIB	60	19	55	92	41	441	460	533	675	767	812	890	979	-



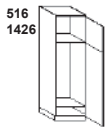
**Appliance unit**  
 1 flap door 25.6 cm  
 1 integrated appliance aperture 122.5 cm  
 1 door 38.6 cm attached to 1 door 90.6 cm  
 1 pull-out 38.6 cm

**Appliance unit with integrated ventilation**

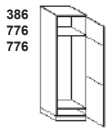


**Appliance unit**  
 1 flap door 25.6 cm  
 1 integrated appliance aperture 122.5 cm  
 1 door 129.6 cm  
 1 pull-out 38.6 cm

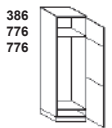
**Appliance unit with integrated ventilation**



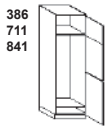
**Appliance unit with integrated ventilation**  
 1 door 51.6 cm  
 1 integrated appliance aperture 122.5 cm  
 1 door 142.6 cm  
 1 adjustable shelf



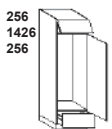
**Appliance unit**  
 1 door 38.6 cm  
 1 integrated appliance aperture 140 cm  
 1 door 77.6 cm connected to 1 door 77.6 cm



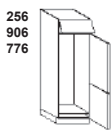
**Appliance unit with integrated ventilation**  
 1 door 38.6 cm  
 1 integrated appliance aperture 140 cm  
 1 door 77.6 cm connected to 1 door 77.6 cm



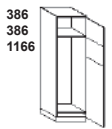
**Appliance unit**  
 1 door 38.6 cm  
 1 integrated appliance aperture 140 cm  
 1 door 71.1 cm attached to 1 door 84.1 cm



**Appliance unit**  
 1 flap door 25.6 cm  
 1 integrated appliance aperture 140.0 cm  
 1 door 142.6 cm  
 1 pull-out 25.6 cm



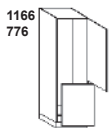
**Appliance unit**  
 1 flap door 25.6 cm  
 1 integrated appliance aperture 144.6 cm  
 1 door 90.6 cm  
 1 door 77.6 cm



**Appliance unit**  
 1 door 38.6 cm  
 1 integrated appliance aperture 144.6 cm  
 1 door 38.6 cm  
 1 door 116.6 cm



**Appliance unit**  
 1 flap door 25.6 cm  
 1 integrated appliance aperture 158 cm  
 1 door 90.6 cm  
 1 door 77.6 cm



**Appliance unit**  
 1 integrated appliance aperture 178 cm  
 1 door 116.6 cm  
 1 door 77.6 cm, supplied separately













Models not available with compensation door: MIAMI, VIVA

## Appliance unit 194.8 cm high for refrigerator/freezer

Carcase depth 55.5 cm (standard)







▲ = Types also available with 61 cm carcass depth (order no. ... replace ... 55 ... with 61)  
Integrated ventilation not possible with appliances with motor in the plinth (Cool Concept)

	Order no. W H D	Hinge side: Carcass depth	Price groups											
			1	2	3	4	5	6	7	8	9			
 <p><b>Appliance unit</b> 1 integrated appliance aperture 177.0 - 178.5 cm 1 door 129.6 cm 1 door 64.6 cm</p>	177,0-178,5	R/L ▲	GI 60 19 55 89 X4	▲	441	460	533	675	767	812	890	979	-	 Important: Observe the appliance manufacturers' permitted front weights for fixed door assembly. See overview of models for front weights.
 <p><b>Appliance unit</b> 1 integrated appliance aperture 177.0 - 178.5 cm 1 door 116.6 cm 1 door 77.6 cm</p> <p><b>Appliance unit with integrated ventilation</b></p>	177,0-178,5 78	R/L ▲	GI 60 19 55 89 X2	▲	441	460	533	675	767	812	890	979	-	 Important: Observe the appliance manufacturers' permitted front weights for fixed door assembly. See overview of models for front weights.
			GIB 60 19 55 89 X2	▲	457	476	549	691	783	828	906	997	-	
 <p><b>Appliance unit</b> 1 integrated appliance aperture 177.0 - 178.5 cm 1 door 116.6 cm connected to 1 door 77.6 cm</p>	177,0-178,5 78	R/L ▲	GI 60 19 55 92 03	▲	441	460	533	675	767	812	890	979	-	 Important: Observe the appliance manufacturers' permitted front weights for fixed door assembly. See overview of models for front weights.
 <p><b>Appliance unit with integrated ventilation</b> 1 integrated appliance aperture 177.0 - 178.5 cm 1 door 110.1 cm connected to 1 door 84.1 cm</p>	177,0-178,5 84,5 NEW	R/L ▲	GIB 60 19 55 89 X8V	▲	457	476	549	691	783	828	906	995	-	 Important: Observe the appliance manufacturers' permitted front weights for fixed door assembly. See overview of models for front weights.
 <p><b>Appliance unit</b> 1 door 194.6 cm 1 integrated appliance aperture 177.0 - 178.5 cm</p> <p><b>Appliance unit with integrated ventilation</b></p>	177,0-178,5	R/L ▲	GI 60 19 55 92 08	▲	524	540	613	756	849	895	971	1068	-	 The tightening fitting will be replaced with carrying-door technology on appliance units. Important: Observe the appliance manufacturers' permitted front weights for fixed door assembly. See overview of models for front weights.
			GIB 60 19 55 92 08	▲	540	557	629	772	864	909	987	1086	-	


## Appliance unit 194.8 cm high for refrigerator/freezer Double aperture

Carcass depth 55.5 cm (standard)

▲ = Types also available with 61 cm carcass depth (order no. ... replace ... 55 ... with 61) Integrated ventilation not possible with appliances with motor in the plinth (Cool Concept)











 <p><b>Appliance unit</b> 1 flap door 25.6 cm 1 integrated appliance aperture 88 cm 1 door 90.6 cm 1 integrated appliance aperture 72 cm 1 door 77.6 cm</p>	88,0 72,0 78	R/L ▲	GI 60 19 55 32 X	▲	441	460	533	675	767	812	890	979	-	 Important: Observe the appliance manufacturers' permitted front weights for fixed door assembly. See overview of models for front weights.
 <p><b>Appliance unit with integrated ventilation</b> 1 integrated appliance aperture 103 cm 1 door 110.1 cm 1 integrated appliance aperture 72 cm 1 door 84.1 cm</p>	103,0 72,0 84,5 NEW	R/L ▲	GIB 60 19 55 42 X8	▲	457	476	549	691	783	828	906	997	-	 Important: Observe the appliance manufacturers' permitted front weights for fixed door assembly. See overview of models for front weights.
 <p><b>Appliance unit</b> 1 integrated appliance aperture 88 cm 1 door 103.6 cm 1 integrated appliance aperture 88 cm 1 door 90.6 cm</p>	88,0 88,0	R/L ▲	GI 60 19 55 33 X	▲	441	460	533	675	767	812	890	979	-	 Important: Observe the appliance manufacturers' permitted front weights for fixed door assembly. See overview of models for front weights.

## spacefitter frame 194.8 cm high

 <p><b>Tall unit spacefitter frame</b> 1 door 129.6 cm connected to 1 door 64.6 cm Carcass depth 10 cm For recess cladding</p>		R/L	GPR 30 19 10 02		230	239	275	359	370	391	435	479	-
		R/L	GPR 45 19 10 02		230	239	275	359	370	391	435	479	-
		R/L	GPR 50 19 10 02		230	239	275	384	400	422	465	512	-
		R/L	GPR 60 19 10 02		258	268	308	448	477	498	549	604	-















# spacefitter frame 194.8 cm high

Order no. W H D	Hinge side: Carcase depth	Price groups										
		1	2	3	4	5	6	7	8	9		
1166 776 	78	GPR 30 19 10 01	R/L	230	239	275	359	370	391	435	479	-
		GPR 45 19 10 01	R/L	230	239	275	359	370	391	435	479	-
		GPR 50 19 10 01	R/L	230	239	275	384	400	422	465	512	-
		GPR 60 19 10 01	R/L	258	268	308	448	477	498	549	604	-
1296 646 	78	GPRS 60 19 10 02	R/L	312	322	364	504	531	553	604	664	-
		GPRS 70 19 10 02	R/L	490	519	583	776	801	830	916	1008	-
		GPRS 80 19 10 02	R/L	524	579	684	932	966	999	1145	1260	-
		 <b>Width 60</b> <b>Width 70, 80 Not available for: ALUELEMENTS, CASTELLO, FRAME, MIAMI, STRIP ELEMENTS, VIVA</b>  <b>Planning advice: only for planning between tall units</b>										
1166 776 	78	GPRS 60 19 10 01	R/L	312	322	364	504	531	553	604	664	-
		GPRS 70 19 10 01	R/L	490	519	583	776	801	830	916	1008	-
		GPRS 80 19 10 01	R/L	524	579	684	932	966	999	1145	1260	-
		 <b>Width 60</b> <b>Width 70, 80 Not available for: ALUELEMENTS, CASTELLO, FRAME, MIAMI, STRIP ELEMENTS, VIVA</b>  <b>Planning advice: only for planning between tall units</b>										
1101 841 	84,5	GPRS 60 19 10 05	R/L	312	322	364	504	531	553	604	664	-
		GPRS 70 19 10 05	R/L	490	519	583	776	801	830	916	1008	-
		GPRS 80 19 10 05	R/L	524	579	684	932	966	999	1145	1260	-
		 <b>Width 60 Not available for: MIAMI, VIVA</b> <b>Width 70, 80 Not available for: ALUELEMENTS, CASTELLO, FRAME, MIAMI, STRIP ELEMENTS, VIVA</b>  <b>Planning advice: only for planning between tall units</b>										

## Passage door elements 194.8 cm high

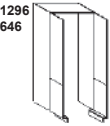
Carcase depth 55.5 cm (standard)

▲ = Types also available with 61 cm carcase depth (order no. ... replace ... 55 ... with 61)

1296 646 	78	GDT 60 19 55 02	R/L ▲	390	409	463	701	758	791	862	948	-
		GDT 70 19 55 02	R/L ▲	570	607	692	978	1041	1079	1194	1313	-
		GDT 80 19 55 02	R/L ▲	602	668	793	1135	1205	1249	1423	1565	-
		 <b>Width 60</b> <b>Width 70, 80 Not available for: ALUELEMENTS, CASTELLO, FRAME, MIAMI, STRIP ELEMENTS, VIVA</b>  <i>The article comprises several packages and is supplied dismantled.</i> <b>Planning advice: only for planning between tall units</b> Width 80 cm = grip strip N775 not available										
1166 776 	78	GDT 60 19 55 01	R/L ▲	390	409	463	701	758	791	862	948	-
		GDT 70 19 55 01	R/L ▲	570	607	692	978	1041	1079	1194	1313	-
		GDT 80 19 55 01	R/L ▲	602	668	793	1135	1205	1249	1423	1565	-
		 <b>Width 60</b> <b>Width 70, 80 Not available for: ALUELEMENTS, CASTELLO, FRAME, MIAMI, STRIP ELEMENTS, VIVA</b>  <i>The article comprises several packages and is supplied dismantled.</i> <b>Planning advice: only for planning between tall units</b> Width 80 cm = grip strip N775 not available										
1101 841 	84,5	GDT 60 19 55 05	R/L ▲	390	409	463	701	758	791	862	948	-
		GDT 70 19 55 05	R/L ▲	570	607	692	978	1041	1079	1194	1313	-
		GDT 80 19 55 05	R/L ▲	602	668	793	1135	1205	1249	1423	1565	-
		 <b>Width 60 Not available for: MIAMI, VIVA</b> <b>Width 70, 80 Not available for: ALUELEMENTS, CASTELLO, FRAME, MIAMI, STRIP ELEMENTS, VIVA</b>  <i>The article comprises several packages and is supplied dismantled.</i> <b>Planning advice: only for planning between tall units</b> Width 80 cm = grip strip N775 not available										
1946 	78	GDT 60 19 55 70	R/L ▲	471	489	543	781	837	871	943	1037	-
		GDT 70 19 55 70	R/L ▲	688	717	803	1091	1151	1190	1303	1433	-
		GDT 80 19 55 70	R/L ▲	720	777	902	1249	1315	1360	1534	1687	-
		 <b>Width 60, 70, 80 Not available for: ALUELEMENTS, ATLANTA-B, ATLANTA-S, BERGEN, CASTELLO, CHALET-B, CHALET-S, CHICAGO, FRAME, LUGANO, LUX-B, MIAMI, MODENA, MUNICH, NEVADA, NOBEL-B, NOBEL-S, ORLANDO-B, ORLANDO-S, OSLO 15, PADUA, SOFIE-B, SOFIE-S, TESSIN 15, TIM 15, VINO, VIVA, YORK-B, YORK-S</b>  <i>Each front has a tightening fitting</i> Ranges without fitting: SMARTGLAS, NOBEL, SOFIE, YORK, LUGANO, TALEA, RIVA, GARDA, ATLANTA, ORLANDO, CHICAGO without tightening fitting <i>The article comprises several packages and is supplied dismantled.</i> <b>Planning advice: only for planning between tall units</b>										

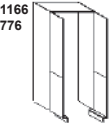
**Passage door elements 194.8 cm high**  
**Carcase depth 55.5 cm (standard)**

▲ = Types also available with 61 cm carcass depth (order no. ... replace ... 55 ... with 61)



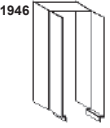
**Passage door element**  
 2 doors 129.6 cm connected with 2 doors 64.6 cm  
 Without bottom shelf  
 With swivelling plinth

**Planning advice:**  
 only for planning  
 between  
 tall units.



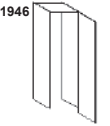
**Passage door element**  
 2 doors 116.6 cm  
 with 2 doors 77.6 cm  
 Without bottom shelf  
 With swivelling plinth

**Planning advice:**  
 only for planning  
 between  
 tall units.



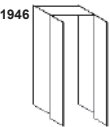
**Passage door element**  
 2 doors 194.6 cm  
 Without bottom shelf  
 With swivelling plinth

**Planning advice:**  
 only for planning  
 between  
 tall units.



**Passage door element**  
 1 door 194.6 cm  
 Without bottom shelf  
 with front extension downwards  
 (depending on the plinth height - max. 20 cm)

**Planning advice:**  
 only for planning  
 between  
 tall units.



**Passage door element**  
 2 doors 194.6 cm  
 Without bottom shelf  
 with front extension downwards  
 (depending on the plinth height - max. 20 cm)

**Planning advice:**  
 only for planning  
 between  
 tall units.








Order no.  
 W H D

Hinge side:	Carcass depth	Price groups									
		1	2	3	4	5	6	7	8	9	
▲	55.5	GDT 90 19 55 02	796	830	925	1087	1152	1208	1329	1462	-
		GDT 100 19 55 02	877	913	1018	1196	1268	1329	1463	1609	-
		GDT 120 19 55 02	955	995	1111	1304	1382	1451	1595	1755	-
The article comprises several packages and is supplied dismantled. <b>Planning advice:</b> only for planning between tall units											
▲	55.5	GDT 90 19 55 01	796	830	925	1087	1152	1208	1329	1462	-
		GDT 100 19 55 01	877	913	1018	1196	1268	1329	1463	1609	-
		GDT 120 19 55 01	955	995	1111	1304	1382	1451	1595	1755	-
The article comprises several packages and is supplied dismantled. <b>Planning advice:</b> only for planning between tall units											
▲	55.5	GDT 90 19 55 70	958	990	1087	1249	1314	1370	1490	1639	-
		GDT 100 19 55 70	1055	1089	1196	1373	1445	1506	1640	1804	-
		GDT 120 19 55 70	1151	1187	1304	1499	1577	1644	1788	1967	-
Width 90, 100, 120 Not available for: ALUELEMENTS, ATLANTA-B, ATLANTA-S, BERGEN, CASTELLO, CHALET-B, CHALET-S, CHICAGO, FRAME, LUGANO, LUX-B, MIAMI, MODENA, MUNICH, NEVADA, NOBEL-B, NOBEL-S, ORLANDO-B, ORLANDO-S, OSLO 15, PADUA, SOFIE-B, SOFIE-S, TESSIN 15, TIM 15, VINO, VIVA, YORK-B, YORK-S Each front has a tightening fitting Ranges without fitting: SMARTGLAS, NOBEL, SOFIE, YORK, LUGANO, TALEA, RIVA, GARDA, ATLANTA, ORLANDO, CHICAGO without tightening fitting The article comprises several packages and is supplied dismantled. <b>Planning advice:</b> only for planning between tall units											
R/L ▲	55.5	GDTV 60 19 55 70	525	543	602	867	955	1003	1088	1197	-
		GDTV 70 19 55 70	741	785	880	1202	1295	1347	1487	1636	-
		GDTV 80 19 55 70	773	842	973	1350	1450	1506	1703	1873	-
Width 60, 70, 80 Not available for: ALUELEMENTS, ATLANTA-B, ATLANTA-S, BERGEN, CASTELLO, CHALET-B, CHALET-S, CHICAGO, FRAME, LUGANO, LUX-B, MIAMI, MODENA, MUNICH, NEVADA, NOBEL-B, NOBEL-S, ORLANDO-B, ORLANDO-S, OSLO 15, PADUA, SOFIE-B, SOFIE-S, TESSIN 15, TIM 15, VINO, VIVA, YORK-B, YORK-S The article comprises several packages and is supplied dismantled. Each front has a tightening fitting Ranges without fitting: SMARTGLAS, NOBEL, SOFIE, YORK, LUGANO, TALEA, RIVA, GARDA, ATLANTA, ORLANDO, CHICAGO without tightening fitting <b>Planning advice:</b> only for planning between tall units											
▲	55.5	GDTV 90 19 55 70	1103	1140	1241	1436	1535	1610	1748	1923	-
		GDTV 100 19 55 70	1206	1249	1360	1572	1677	1766	1915	2107	-
		GDTV 120 19 55 70	1319	1368	1490	1720	1836	1942	2105	2316	-
Width 90, 100, 120 Not available for: ALUELEMENTS, ATLANTA-B, ATLANTA-S, BERGEN, CASTELLO, CHALET-B, CHALET-S, CHICAGO, FRAME, LUGANO, LUX-B, MIAMI, MODENA, MUNICH, NEVADA, NOBEL-B, NOBEL-S, ORLANDO-B, ORLANDO-S, OSLO 15, PADUA, SOFIE-B, SOFIE-S, TESSIN 15, TIM 15, VINO, VIVA, YORK-B, YORK-S The article comprises several packages and is supplied dismantled. <b>Planning advice:</b> only for planning between tall units											







# Front filler 194.8 cm high

Carcase depth 55.5 cm (standard)



				Price groups										
		Order no. W H D		Hinge side:	Carcase depth	1	2	3	4	5	6	7	8	9
	<b>Tall unit front filler</b> one-part, 194.8 cm high 3.5 - 10 cm 10.1 - 20 cm			 <b>Note: Models with horizontal veneer graining can only be supplied with 2-part front trim panel</b>										
				<b>GP 10 19</b>	85	85	93	144	144	144	157	173	-	
				<b>GP 20 19</b>	93	93	107	170	170	170	182	200	-	
	<b>Tall unit corner filler 90°</b> 194.8 cm high As corner connection between 2 tall units Without shelf, 9.5 x 9.5 cm			<b>GPW 90 19</b>										
				124 124 138 200 200 200 214 235 -										
				 <b>Note: Models with horizontal veneer graining can only be supplied with 2-part front trim panel</b>										
	<b>Tall unit corner filler 135°</b> 194.8 cm high For cladding blind corners Planning dimensions 25.9 x 25.9 cm			<b>GPW 135 19</b>										
				124 124 138 200 200 200 214 235 -										
				 <b>Not available for: ALU TEC RP</b>  <b>Note: Models with horizontal veneer graining can only be supplied with 2-part front trim panel</b>										

## Back cladding 194.8 cm high with screw-fitted fronts



Carcase depth 55.5 cm (standard)

	<b>Back cladding</b> For tall units, 194.8 cm high Carcase material with screw-fitted fronts, 116.6 cm and 77.6 cm Only available in grid sizes	78	per 10 cm Width											
				<b>GVF 19 01</b>	65	68	71	89	91	95	101	111	-	
				 <b>Important!</b> Plinth panel is supplied loose.										
	<b>Back cladding</b> For tall units, 194.8 cm high Carcase material with screw-fitted fronts 1 front 129.6 cm attached to 1 front 64.6 cm Only available in grid sizes		per 10 cm Width											
				<b>GVF 19 02</b>	65	68	71	89	91	95	101	111	-	
				 <b>Important!</b> Plinth panel is supplied loose.										

## Back cladding 194.8 cm high

				Decor groups										
		Order no. W H D		Hinge side:	Carcase depth	M10	M20	M30	M40	M50	M60	M70	M80	M90
	<b>Back cladding</b> For tall units, 194.8 cm high 16 mm thick			per 10 cm Width										
				<b>GVK 19</b>	27,50	48	70	93	93	93	93	93	-	
	<b>Tall unit background filler</b> Width: 20 cm For fitting flush with carcass 194.8 cm high			<b>GPSL 00 19</b>										
				45 53 110 146 146 146 146 146 -										
<b>M 10</b>	<b>M 20</b>	<b>M 30</b>	<b>M 40</b>	<b>M 50</b>										
K M10 laminate	D M20 Laminate decor	I M30 RESOPAL PRO super matt IH M30 HPL PRO PW M30 PRIMEWOOD/Basic Veneer	A M40 DIRECTLACK matt L M40 DIRECTLACK high-gloss	B M50 Velvet lacquer S M50 microstructure lacquer										
<b>M 60</b>	<b>M 70</b>	<b>M 80</b>	<b>M 90</b>											
QH M60 SMARTGLAS high-gloss QM M60 SMARTGLAS satin-finish	F M70 veneer / oak / walnut Z M70 Veneer / Bavaria	C1 M80 FENIX stainless-steel look H M80 high gloss-Lacquer MP M80 laqué mat Premium												

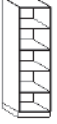
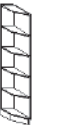

# Visible sides / increased side depth 194.8 cm high

		Decor groups										
		M10	M20	M30	M40	M50	M60	M70	M80	M90		
Order no. W H D												
 <p><b>Tall unit visible side</b></p> <p>55.5 cm side depth Fixed dimension, not variable</p> <p>57.5 cm side depth Fixed dimension, not variable</p> <p>60.5 cm side depth Fixed dimension, not variable</p> <p>61 cm side depth Fixed dimension, not variable</p>	<p><b>Tall unit visible side</b></p> <p>55.5 cm side depth Fixed dimension, not variable</p> <p>57.5 cm side depth Fixed dimension, not variable</p> <p>60.5 cm side depth Fixed dimension, not variable</p> <p>61 cm side depth Fixed dimension, not variable</p>	<p><b>Important!</b> Installation instead of a normal unit side. Only available in the listed side depths. For other dimensions, use GSVT...</p>										
		<b>GSV 19</b>	R/L	0	0	135	135	179	179	248	301	-
		<b>GSV 19 5</b>	R/L	0	0	135	135	179	179	248	301	-
		<b>GSV 19 6</b>	R/L	0	0	135	135	179	179	248	301	-
		<b>GSV 19 6 1</b>	R/L	0	0	135	135	179	179	248	301	-
 <p><b>Tall unit increased side depth</b></p> <p>from 61.1 cm up to 90 cm side depth</p> <p>Up to 60.9 cm side depth</p>	<p><b>Tall unit increased side depth</b></p> <p>from 61.1 cm up to 90 cm side depth</p> <p>Up to 60.9 cm side depth</p>	<p><b>Important!</b> Installation instead of a normal unit side.</p>										
		<b>GSVT 19</b>	R/L	88	118	295	295	392	392	536	626	-
		<b>GSVT 19 6</b>	R/L	45	58	196	196	262	262	361	440	-
<b>M 10</b>	<b>M 20</b>	<b>M 30</b>		<b>M 40</b>		<b>M 50</b>						
K M10 laminate	D M20 Laminate decor	I M30 RESOPAL PRO super matt IH M30 HPL PRO PW M30 PRIMEWOOD/Basic Veneer		A M40 DIRECTLACK matt L M40 DIRECTLACK high-gloss		B M50 Velvet lacquer P M50 Soft lacquer RH M50 Velvet lacquer wood texture RW M50 Velvet lacquer spackle effect S M50 microstructure lacquer						
<b>M 60</b>	<b>M 70</b>	<b>M 80</b>		<b>M 90</b>								
QH M60 SMARTGLAS high-gloss QM M60 SMARTGLAS satin-finish	F M70 veneer / oak / walnut V M70 Velvet lacquer textured Z M70 Veneer / Bavaria	C1 M80 FENIX stainless-steel look H M80 high gloss-Lacquer MP M80 laqué mat Premium O M80 Veneered										

## Shelf units 194.8 cm high

Carcase depth 57.7 cm, flush with front

■ = = Models also available in 36.1/47.7/63.2 cm carcass depth (Order no.: replace ... 58 ... with 36/48/63)

		Decor groups											
		M10	M20	M30	M40	M50	M60	M70	M80	M90			
 <p><b>Tall shelf unit</b></p> <p>1 fixed shelf 3 adjustable shelves</p> <p>wide in cm: 13-30</p> <p>wide in cm: 30,1-40</p> <p>wide in cm: 40,1-45</p> <p>wide in cm: 45,1-50</p> <p>wide in cm: 50,1-60</p>	<p><b>Tall shelf unit</b></p> <p>1 fixed shelf 3 adjustable shelves</p> <p>wide in cm: 13-30</p> <p>wide in cm: 30,1-40</p> <p>wide in cm: 40,1-45</p> <p>wide in cm: 45,1-50</p> <p>wide in cm: 50,1-60</p>	<p><b>GR 30 19 58</b> ■ 367 - - - 1388 - 1388 1388 -</p> <p><b>GR 40 19 58</b> ■ 367 - - - 1388 - 1388 1388 -</p> <p><b>GR 45 19 58</b> ■ 367 - - - 1388 - 1388 1388 -</p> <p><b>GR 50 19 58</b> ■ 367 - - - 1388 - 1388 1388 -</p> <p><b>GR 60 19 58</b> ■ 367 - - - 1388 - 1388 1388 -</p>											
		 <p><b>Tall shelf end unit</b></p> <p>25 x 57.7 cm 4 fixed shelves For adjacent fitting left or right</p>	<p><b>Tall shelf end unit</b></p> <p>25 x 57.7 cm 4 fixed shelves For adjacent fitting left or right</p>	<p><b>GRA 25 19 58</b> R/L ■ 465 - - - 1199 - 1199 1199 -</p> <p><b>Important!</b> Only available in 25 cm width</p>									
		 <p><b>Tall shelf end unit</b></p> <p>34 x 57.7 cm 4 fixed shelves For adjacent fitting left or right</p>	<p><b>Tall shelf end unit</b></p> <p>34 x 57.7 cm 4 fixed shelves For adjacent fitting left or right</p>	<p><b>GRA 34 19 58</b> R/L ■ 465 - - - 1371 - 1371 1371 -</p>									
		<b>M 10</b>	<b>M 20</b>	<b>M 30</b>		<b>M 40</b>		<b>M 50</b>					
K M10 laminate						B M50 Velvet lacquer S M50 microstructure lacquer							
<b>M 60</b>	<b>M 70</b>	<b>M 80</b>		<b>M 90</b>									
	F M70 veneer / oak / walnut Z M70 Veneer / Bavaria	H M80 high gloss-Lacquer MP M80 laqué mat Premium											



# Raised dishwashers

For carcass height 194.8 cm, carcass depth 55.5 cm

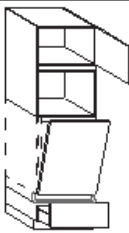
Pull-out panel at bottom 25.6 cm high

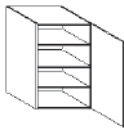
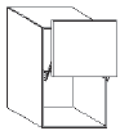
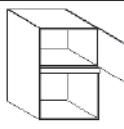

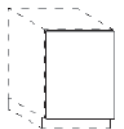


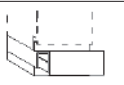


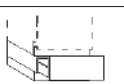

**Note:**

Do not plan at the end of a row. Only plan between tall units.

Always follow the assembly instructions from the appliance manufacturers.

▲ = Types also available with 61 cm carcass depth (order no. ... replace ... 55 ... with 61)



Order no. W H D		Hinge side: Carcass depth	Price groups													
			1	2	3	4	5	6	7	8	9					
906	 <p><b>Dresser unit above raised dishwasher</b> Height 92.3 cm 1 door 90.6 cm 3 adjustable shelves 1 vapour protector</p>	A	60	92	55	R/L ▲	265	279	298	369	418	444	489	538	-	
386 516	 <p><b>Dresser unit with lifting door for microwave above raised dishwasher</b> Height 92.3 cm 1 door 38.6 cm 1 lifting door with front 51.6 cm 1 vapour protector</p>	ALT	60	92	55	R/L ▲	422	432	451	523	564	583	658	724	-	
386	 <p><b>Dresser unit for microwave above raised dishwasher</b> Height 92.3 cm 1 door 38.6 cm 1 panel 1 appliance aperture 35 - 45 cm 1 vapour protector</p>	35,0-45,0	<p> <b>Not available for:</b> ALU TEC RP, MIAMI, VIVA</p>													
		AN	60	92	55	2	R/L ▲	265	279	298	369	418	444	489	538	-
		AN	60	92	55	2A	R/L ▲	265	279	298	369	418	444	489	538	-
776	 <p><b>Base unit door, 77.6 cm</b> 59.6 cm wide As front panel for fully integrated dishwashers 86 cm high and pull-out fridges and freezers  59.6 cm wide with 60 cm</p>	<p> <i>Always order article DL 60 6 if a high-volume dishwasher has not been included in planning!</i></p>														
		UT	60	78	1			122	126	138	146	232	253	294	323	-
	 <p><b>Spacer strips for fully integrated dishwasher</b> Appliance height 82 cm 2 spacer strips Colour: Art Pepper 6 cm high</p>	DL	60	6				32								
256	 <p><b>Base for raised dishwasher (86 cm high)</b> with top shelf, 15.5 cm high 1 drawer with pull-out panel 25.6 cm, 45.5 cm deep angled at top 1 collection tray (available only in 60 cm width)</p>	UGS	60	10	55	87	▲	276	290	320	378	412	439	480	528	-
		<p> <b>Width 60 Not available for:</b> ALU TEC RP</p>														
		<p> <b>Important!</b> Plan free-standing with 25 mm panels</p>														
256	 <p><b>Base for raised dishwasher (86 cm high)</b> only for dishwashers with <b>VARIO HINGE</b> with top shelf, 15.5 cm high 1 drawer with pull-out panel 25.6 cm not angled 45.5 cm deep 1 collection tray (available only in 60 cm width)</p>	UGV	60	10	55	87	▲	276	290	320	378	412	439	480	528	-
		<p> <b>Important!</b> Plan free-standing with 25 mm panels</p>														

# Raised dishwashers

For carcass height 194.8 cm, carcass depth 55.5 cm

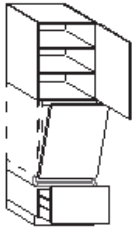
Pull-out panel at bottom 38.6 cm high

**Note:**

Do not plan at the end of a row. Only plan between tall units.

Always follow the assembly instructions from the appliance manufacturers.

▲ = Types also available with 61 cm carcass depth (order no. ... replace ... 55 ... with 61)



			Price groups										
Order no.			Hinge side:	Carcass depth	1	2	3	4	5	6	7	8	9
W	H	D											
776		<b>Dresser unit above raised dishwasher</b> Height 79.3 cm 1 door 77.6 cm 2 adjustable shelves 1 vapour protector		R/L ▲	245	255	273	338	384	407	447	492	-
256 516		<b>Dresser unit with lifting door for microwave above raised dishwasher</b> Height 79.3 cm 1 flap door 25.6 cm 1 lifting door with front 51.6 cm 1 vapour protector		▲	400	408	427	494	527	547	618	680	-
256		<b>Dresser unit for microwave above raised dishwasher</b> Height 79.3 cm 1 flap door 25.6 cm 1 panel 1 appliance aperture 35 - 45 cm 1 vapour protector	35,0-45,0										
				<b>Not available for:</b> ALU TEC RP, MIAMI, VIVA									
				▲	359	360	371	394	394	402	422	464	-
				▲	359	360	371	394	394	402	422	464	-
776		<b>Base unit door, 77.6 cm</b> 59.6 cm wide As front panel for fully integrated dishwashers 86 cm high and pull-out fridges and freezers 59.6 cm wide with 60 cm											
				Always order article DL 60 6 if a high-volume dishwasher has not been included in planning!									
					122	126	138	146	232	253	294	323	-
		<b>Spacer strips for fully integrated dishwasher</b> Appliance height 82 cm 2 spacer strips Colour: Art Pepper 6 cm high			32								
386		<b>Base for raised dishwasher (86 cm high)</b> with top shelf, 28.5 cm high 1 pull-out 38.6 cm, 45.5 cm deep angled at top 1 collection tray (available only in 60 cm width)		▲	285	298	326	389	419	445	485	534	-
				<b>Not available for:</b> ALU TEC RP									
				Important! Plan free-standing with 25 mm panels									
386		<b>Base for raised dishwasher (86 cm high)</b> only for dishwashers with <b>VARIO HINGE</b> with top shelf, 28.5 cm high 1 pull-out panel 38.6 cm, 45.5 cm deep not angled 1 collection tray (available only in 60 cm width)		▲	285	298	326	389	419	445	485	534	-
				Important! Plan free-standing with 25 mm panels									

# Raised dishwashers

For carcass height 194.8 cm, carcass depth 55.5 cm

Pull-out panel at bottom 32.1 cm high

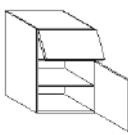
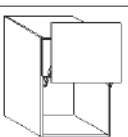
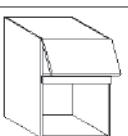
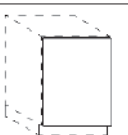

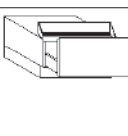
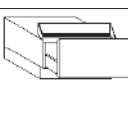

**Note:**

Do not plan at the end of a row. Only plan between tall units.

Always follow the assembly instructions from the appliance manufacturers.

▲ = Types also available with 61 cm carcass depth (order no. ... replace ... 55 ... with 61)



Order no. W H D		Hinge side: R/L ▲	Carcass depth	Price groups										
				1	2	3	4	5	6	7	8	9		
321 516	 <p><b>Dresser unit above raised dishwasher</b> Height 85.8 cm 1 flap door 32.1 cm 1 door 51.6 cm 1 adjustable shelf 1 vapour protector</p>	A	60 85 55	R/L ▲	318	330	360	437	470	502	547	602	-	
				Width 60 Not available for: MIAMI, VIVA										
321 516	 <p><b>Dresser unit with lifting door for microwave above raised dishwasher</b> Height 85.8 cm 1 flap door 32.1 cm 1 lifting door with front 51.6 cm 1 vapour protector</p>	ALT	60 85 55	▲	473	496	515	589	616	639	718	790	-	
				Width 60 Not available for: MIAMI, VIVA										
321	 <p><b>Dresser unit for microwave above raised dishwasher</b> Height 85.8 cm 1 flap door 32.1 cm 1 panel 1 appliance aperture 35 - 45 cm 1 vapour protector</p>	35,0-45,0												
				Not available for: ALU TEC RP, MIAMI, VIVA										
776	 <p><b>Base unit door, 77.6 cm</b> 59.6 cm wide As front panel for fully integrated dishwashers 86 cm high and pull-out fridges and freezers 59.6 cm wide with 60 cm</p>													
				Always order article DL 60 6 if a high-volume dishwasher has not been included in planning!										
	 <p><b>Spacer strips for fully integrated dishwasher</b> Appliance height 82 cm 2 spacer strips Colour: Art Pepper 6 cm high</p>			UT	60 78 1	122	126	138	146	232	253	294	323	-
				DL	60 6	32								
321	 <p><b>Base for raised dishwasher with top shelf, 22.0 cm high</b> 1 drawer with pull-out panel 32.1 cm, 45.5 cm deep, angled at top 1 collection tray (available only in 60 cm width)</p>	UGS	60 15 55 871	▲	276	290	320	378	412	439	480	528	-	
				Width 60 Not available for: ALU TEC RP, MIAMI, VIVA										
	 <p><b>Base for raised dishwasher only for dishwashers with VARIO HINGE</b> with top shelf, 22.0 cm high 1 drawer with pull-out panel 32.1 cm, 45.5 cm deep, not chamfered 1 collection tray (available only in 60 cm width)</p>													
				Important! Plan free-standing with 25 mm panels										
	 <p><b>Vapour protector for raised dishwashers</b> Finish: metal to protect the fronts above</p>			WSB-45		11								
				WSB-60		12								

# Raised dishwashers

For carcass height 194.8 cm, carcass depth 55.5 cm

Pull-out panel at bottom 45.1 cm high

**Note:**

Do not plan at the end of a row. Only plan between tall units.

Always follow the assembly instructions from the appliance manufacturers.

▲ = Types also available with 61 cm carcass depth (order no. ... replace ... 55 ... with 61)



		Order no.		Hinge side:	Carcass depth	Price groups										
		W	H			D	1	2	3	4	5	6	7	8	9	
711	<p><b>Dresser unit above raised dishwasher</b> Height 72.8 cm 1 door 71.1 cm 2 adjustable shelves 1 vapour protector</p>	<b>A</b>	<b>60</b>	<b>73</b>	<b>55</b>	R/L ▲	240	251	268	331	375	400	441	485	-	
		Not available for: MIAMI, VIVA														
321 386	<p><b>Dresser unit with lifting door for microwave above raised dishwasher</b> Height 72.8 cm 1 flap door 32.1 cm 1 lifting door with front 38.6 cm 1 vapour protector</p>	<b>ALT</b>	<b>60</b>	<b>73</b>	<b>55</b>	▲	390	399	413	478	511	525	601	661	-	
		Not available for: MIAMI, VIVA														
	<p><b>Dresser unit for microwave above raised dishwasher</b> Height 72.8 cm 1 panel 1 appliance aperture 35 - 45 cm 1 vapour protector</p>	<b>AN</b>	<b>60</b>	<b>73</b>	<b>55</b>	<b>2</b>	▲	240	251	268	331	375	400	441	485	-
		Not available for: ALU TEC RP, MIAMI, VIVA														
776	<p><b>Base unit door, 77.6 cm</b> 59.6 cm wide As front panel for fully integrated dishwashers 86 cm high and pull-out fridges and freezers 59.6 cm wide with 60 cm</p>	35,0-45,0				▲	240	251	268	331	375	400	441	485	-	
		Always order article DL 60 6 if a high-volume dishwasher has not been included in planning!														
	<p><b>Spacer strips for fully integrated dishwasher</b> Appliance height 82 cm 2 spacer strips Colour: Art Pepper 6 cm high</p>	<b>DL</b>	<b>60</b>	<b>6</b>			32									
451	<p><b>Base for raised dishwasher (86 cm high)</b> with top shelf, 35.0 cm high 1 pull-out 45.1 cm, 45.5 cm deep angled at top 1 collection tray (available only in 60 cm width)</p>	<b>UGS</b>	<b>60</b>	<b>12</b>	<b>55</b>	<b>87</b>	▲	295	306	337	401	431	459	500	550	-
		Not available for: ALU TEC RP														
		Important! Plan free-standing with 25 mm panels														
451	<p><b>Base for raised dishwasher (86 cm high)</b> only for dishwashers with <b>VARIO HINGE</b> with top shelf, 35.0 cm high 1 pull-out panel 45.1 cm, 45.5 cm deep not angled 1 collection tray (available only in 60 cm width)</p>	<b>UGV</b>	<b>60</b>	<b>12</b>	<b>55</b>	<b>87</b>	▲	295	306	337	401	431	459	500	550	-
		Width 60 Not available for: ALU TEC RP														
		Important! Plan free-standing with 25 mm panels														
	<p><b>Vapour protector for raised dishwashers</b> Finish: metal to protect the fronts above</p>	<b>WSB-45</b>					11									
		<b>WSB-60</b>					12									

# 6.6

## Tall units 207.8 cm

Tall units 207.8 cm high	XL 6.6.4-XL 6.6.8
Tall units 207.8 cm high with glass fronts	XL 6.6.9
Additional equipment	XL 6.6.9
Tall units 207.8 cm high with roller shutter	XL 6.6.10
Appliance unit 207.8 cm high for microwave / oven	XL 6.6.11-XL 6.6.13
Appliance unit 207.8 cm high for microwave / oven Double aperture	XL 6.6.14-XL 6.6.16
Appliance unit 207.8 cm high for microwave / oven Lifting door / aperture	XL 6.6.16-XL 6.6.17
Appliance unit 207.8 cm high for microwave / oven 30 inches wide (76.2 cm)	XL 6.6.17-XL 6.6.18
Appliance unit 207.8 cm high for refrigerator/freezer	XL 6.6.18-XL 6.6.22
Appliance unit 207.8 cm high for refrigerator/freezer Double aperture	XL 6.6.22
Appliance unit 207.8 cm high for refrigerator/freezer	XL 6.6.23
Fronts for Side by Side refrigerators/freezers 207.8 cm high	XL 6.6.23-XL 6.6.24
spacefitter frame 207.8 cm high	XL 6.6.24
Passage door elements 207.8 cm high	XL 6.6.24-XL 6.6.26
Front filler 207.8 cm high	XL 6.6.26-XL 6.6.27
Back cladding 207.8 cm high with screw-fitted fronts	XL 6.6.27
Back cladding 207.8 cm high	XL 6.6.27
Visible sides / increased side depth 207.8 cm high	XL 6.6.28
Shelf units 207.8 cm high	XL 6.6.28
Raised dishwashers For carcass height 207.8 cm, carcass depth 55.5 cm	XL 6.6.29
Raised dishwashers For carcass height 207.8 cm, carcass depth 55.5 cm	XL 6.6.30
Raised dishwashers For carcass height 207.8 cm, carcass depth 55.5 cm	XL 6.6.31
Raised dishwashers For carcass height 207.8 cm, carcass depth 55.5 cm	XL 6.6.32

### Legend:



Available with grip ledge N...



Not available with grip ledge N...



This symbol indicates which models are available



This symbol indicates which models are not available



wall-mounted units



available depths for wall-mounted units



Planning advice



This symbol illustrates which appliance units are delivered with integrated ventilation



Not available with „push-to-open“ fitting



Aperture height specifications



Available carcass depths 34/45.5/55.5/61.0 cm

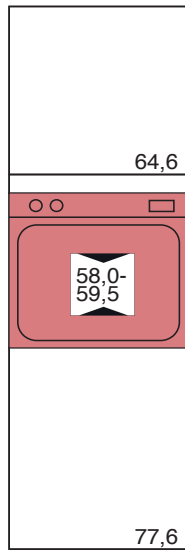


Available carcass depths 45.5/55.5/61.0 cm



Available carcass depths 55.5/61.0 cm

## Planning advice for appliance shelves with compensation panels or compensation door



Door

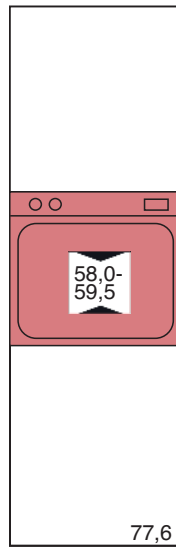
Compensation panel

64,6

58,0-  
59,5

77,6

GO60205520X



Compensation door  
64.6 cm + compensation panel

By changing the order number, the compensation panels above the appliance apertures can be replaced by a special-size door or lifting door.

Advantages:

- Full use can be made of the storage space above the appliance aperture
- Reduction of horizontal joints



**Not available for models:  
MIAMI, VIVA**

Height  
207,8 cm

# The most important tall unit types 207.8 cm high

Page XL 6.6.4	Page XL 6.6.4	Page XL 6.6.4	Page XL 6.6.4	Page XL 6.6.4	Page XL 6.6.4	Page XL 6.6.4	Page XL 6.6.4	Page XL 6.6.4
GGs..205502 Unit widths: 25	GGs..205501 Unit widths: 25	GV..205502 Unit widths: 30/45	GV..205501 Unit widths: 30/45	GV..205570 Unit widths: 30/45	GVP..205502 Unit widths: 30/45	GVP..205501 Unit widths: 30/45	GVP..205570 Unit widths: 30/45	GVP..205501 Unit widths: 50/60
Page XL 6.6.5	Page XL 6.6.5	Page XL 6.6.5	Page XL 6.6.5	Page XL 6.6.5	Page XL 6.6.5	Page XL 6.6.5	Page XL 6.6.5	Page XL 6.6.5
GVP..0205501 Unit widths: 100	GV..205502 Unit widths: 50/60	GV..205501 Unit widths: 50/60	GVPS..2055 Unit widths: 60	GVT..205501 Unit widths: 50/60	GVPT..205501 Unit widths: 50/60	GG..205502 Unit widths: 30/40/45/50/60	GG..205512 Unit widths: 30/40/45/50/60	GG..205504 Unit widths: 30/40/45/50/60
Page XL 6.6.5	Page XL 6.6.5	Page XL 6.6.6	Page XL 6.6.6	Page XL 6.6.6	Page XL 6.6.6	Page XL 6.6.6	Page XL 6.6.6	Page XL 6.6.6
GG..205507 Unit widths: 30/40/45/50/60	GG..205501 Unit widths: 30/40/45/50/60	GG..205501 Unit widths: 80/90	GGA..205508 Unit widths: 30/40/45/50/60	GG..205573 Unit widths: 30/40/45/50/60	GGA..205501 Unit widths: 30/40/45/50/60	GGA..205502 Unit widths: 30/40/45/50/60	GGA..205503 Unit widths: 90	GGA..205502 Unit widths: 90/100
Page XL 6.6.6	Page XL 6.6.6	Page XL 6.6.7	Page XL 6.6.7	Page XL 6.6.7	Page XL 6.6.7	Page XL 6.6.7	Page XL 6.6.7	Page XL 6.6.7
GG..205505 Unit widths: 30/40/45/50/60	GGA..2055081 Unit widths: 30/40/45/50/60	GGA..205506 Unit widths: 30/40/45/50/60	GG..2055021 Unit widths: 30/40/45/50/60	GG..205570 Unit widths: 30/40/45/50/60	GGA..205571 Unit widths: 30/40/45/50/60	GGA..205572 Unit widths: 30/40/45/50/60	GB..205502 Unit widths: 30/40/45/50/60	GB..205501 Unit widths: 30/40/45/50/60
Page XL 6.6.7	Page XL 6.6.8	Page XL 6.6.10	Page XL 6.6.19	Page XL 6.6.24	Page XL 6.6.24	Page XL 6.6.24	Page XL 6.6.24	Page XL 6.6.24
GB..2055021 Unit widths: 30/40/45/50/60	GB..205571 Unit widths: 40/45/50/60	TAB-AZ..55 Unit widths: 45/50/60/80/90	GOIB..205502X Unit widths: 60	GPR..201002 Unit widths: 30/45/50/60	GPR..201001 Unit widths: 30/45/50/60	GPRS..201001 Unit widths: 60/70/80	GPRS..201005 Unit widths: 60/70/80	GDT..205502 Unit widths: 60/70/80
Page XL 6.6.25	Page XL 6.6.25	Page XL 6.6.25	Page XL 6.6.25	Page XL 6.6.25	Page XL 6.6.26	Page XL 6.6.26	Page XL 6.6.27	Page XL 6.6.27
GDT..205505 Unit widths: 60/70/80	GDT..205502 Unit widths: 90/100/120	GDT..205501 Unit widths: 90/100/120	GDT..205570 Unit widths: 90/100/120	GDTV..205570 Unit widths: 60/70/80	GP..20 Unit widths: 3,5-20	GPW..20 Unit widths: 9,5x9,5	GPW..20 Unit widths: 25,9x25,9	GVF..01 Unit widths: 10-250



# The most important tall unit types 207.8 cm high

Page XL 6.6.27



Page XL 6.6.28



Page XL 6.6.28



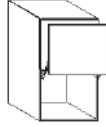
Page XL 6.6.28



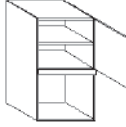
Page XL 6.6.29



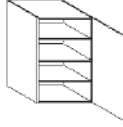
Page XL 6.6.29



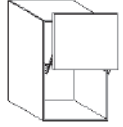
Page XL 6.6.29



Page XL 6.6.30



Page XL 6.6.30



**GVF..02**

Unit widths:  
10-250

**GR..2058**

Unit widths:  
30/40/45/50/60

**GRA..2058**

Unit widths:  
25/34

**GRA..2058**

Unit widths:  
25/34

**A..1055**

Unit widths:  
60

**ALT..1055**

Unit widths:  
60

**AN..10552**

Unit widths:  
60

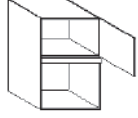
**A..9255**

Unit widths:  
60

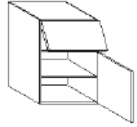
**ALT..9255**

Unit widths:  
60

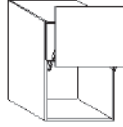
Page XL 6.6.30



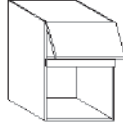
Page XL 6.6.32



Page XL 6.6.32



Page XL 6.6.32



**AN..92552**

Unit widths:  
60

**A..8555**

Unit widths:  
60

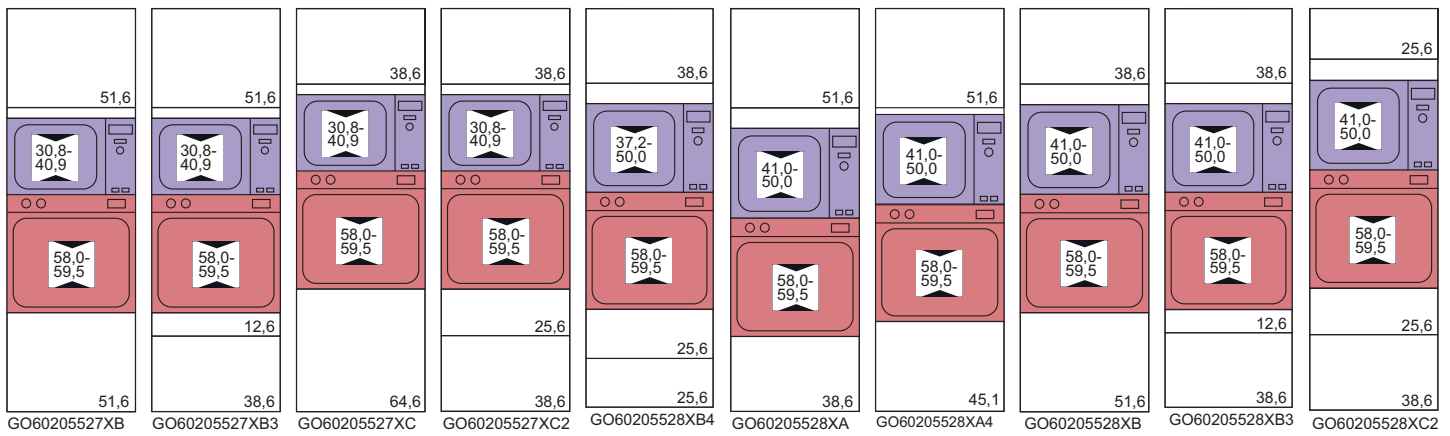
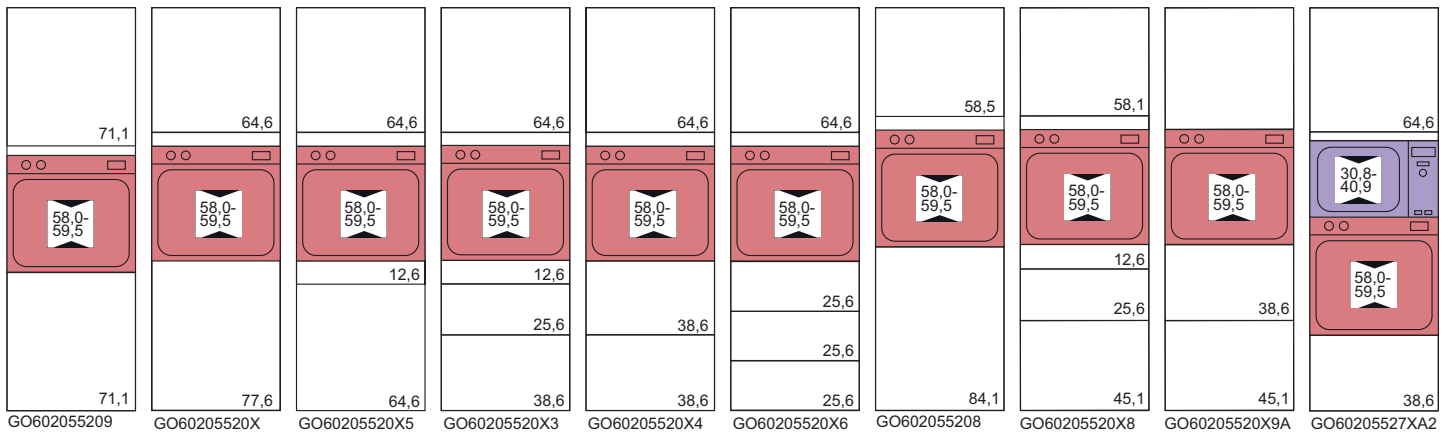
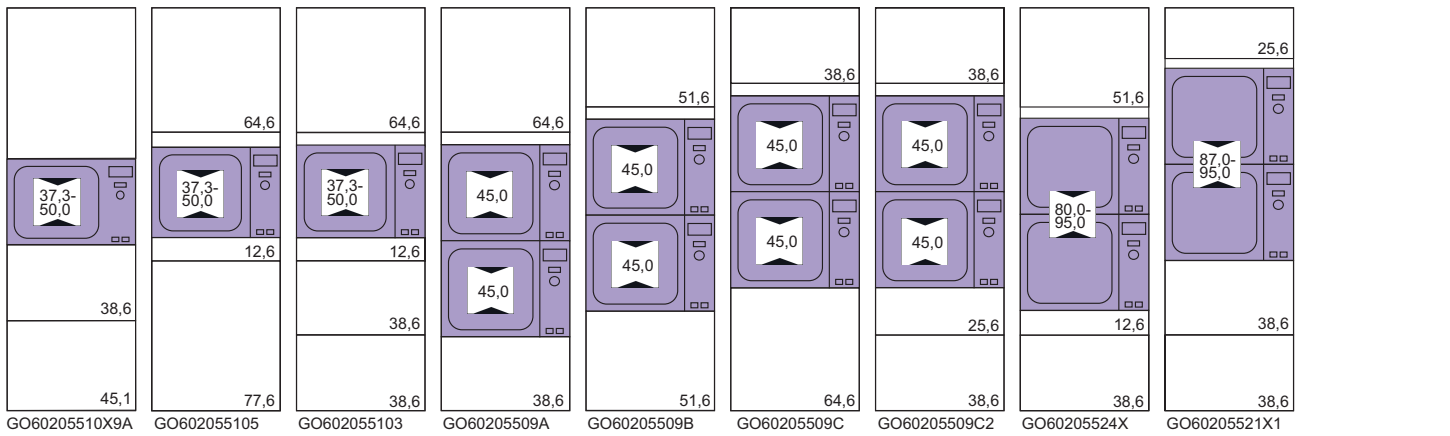
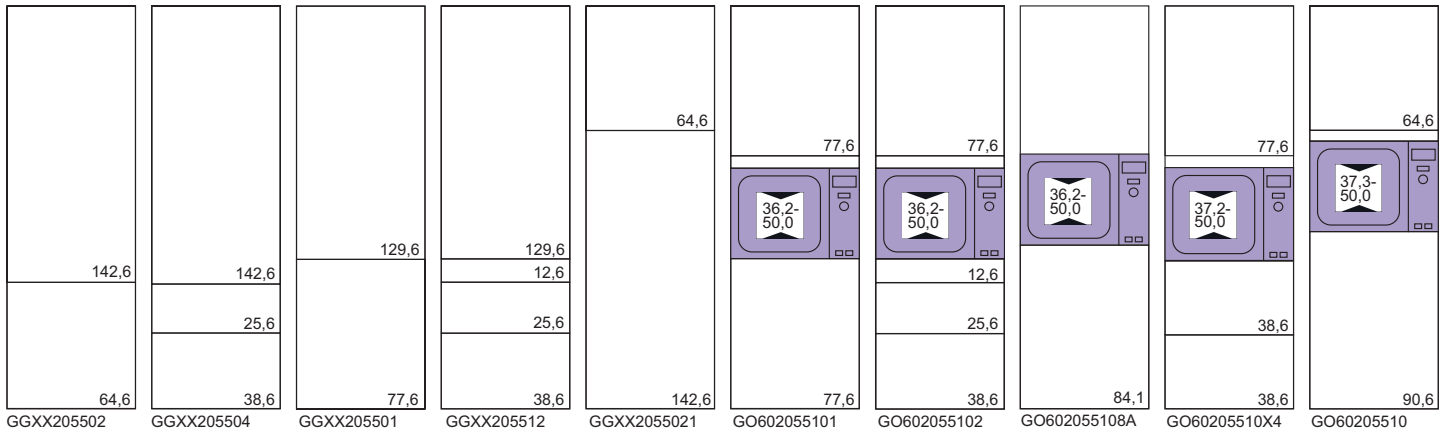
**ALT..8555**

Unit widths:  
60

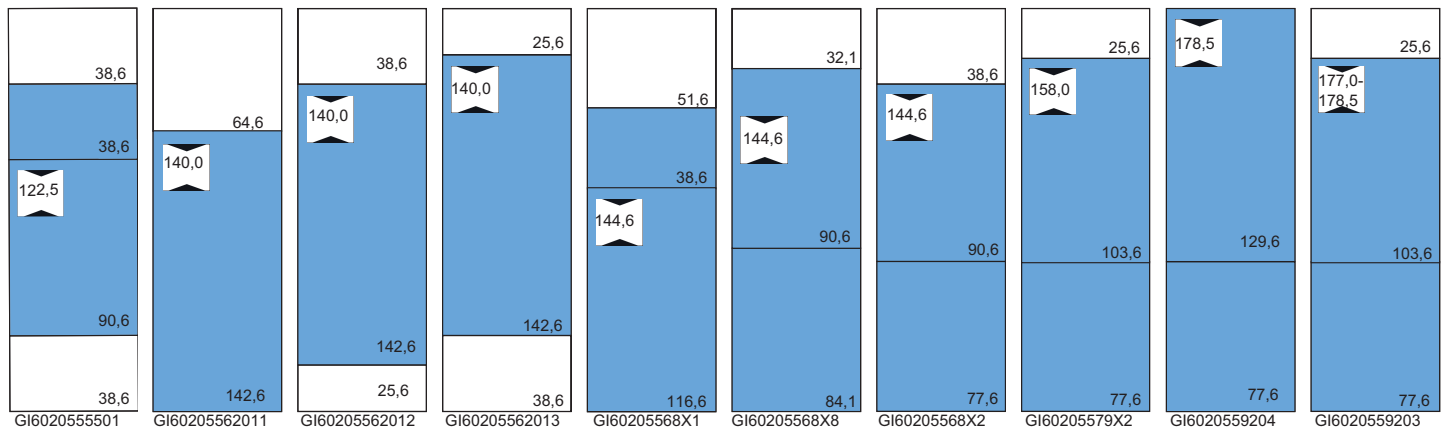
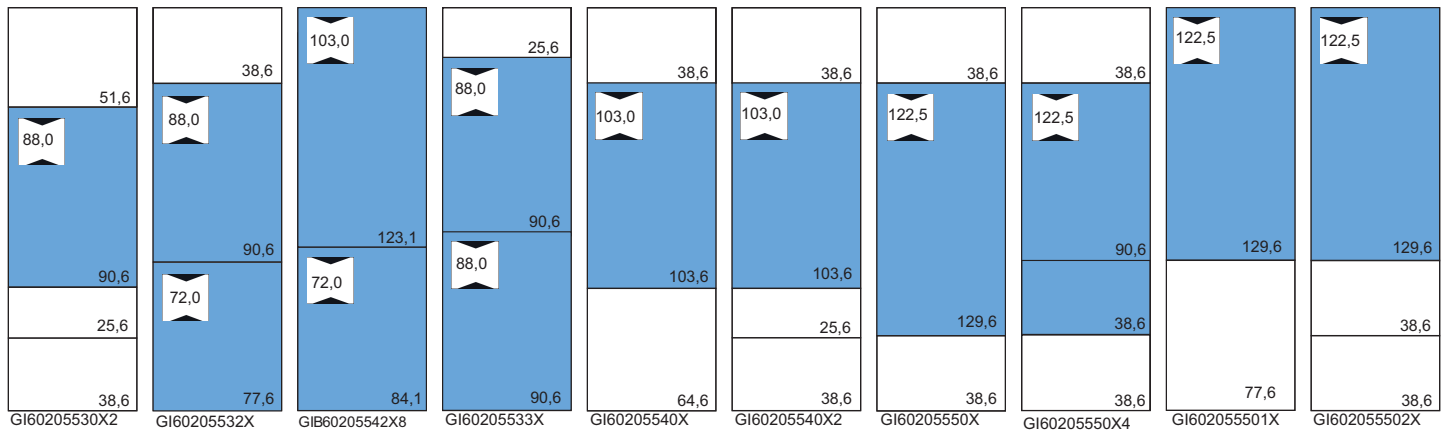
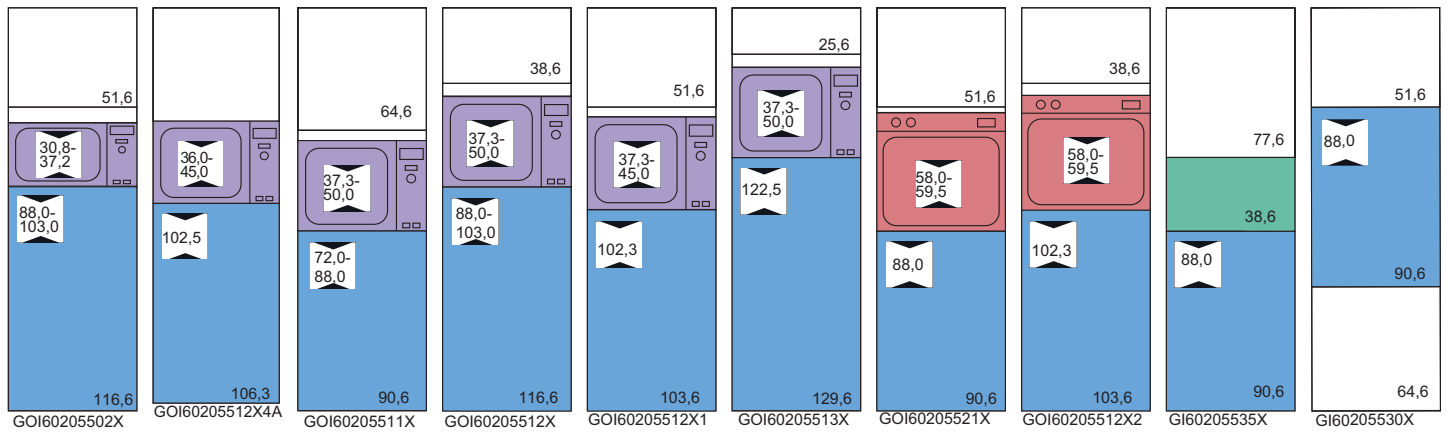
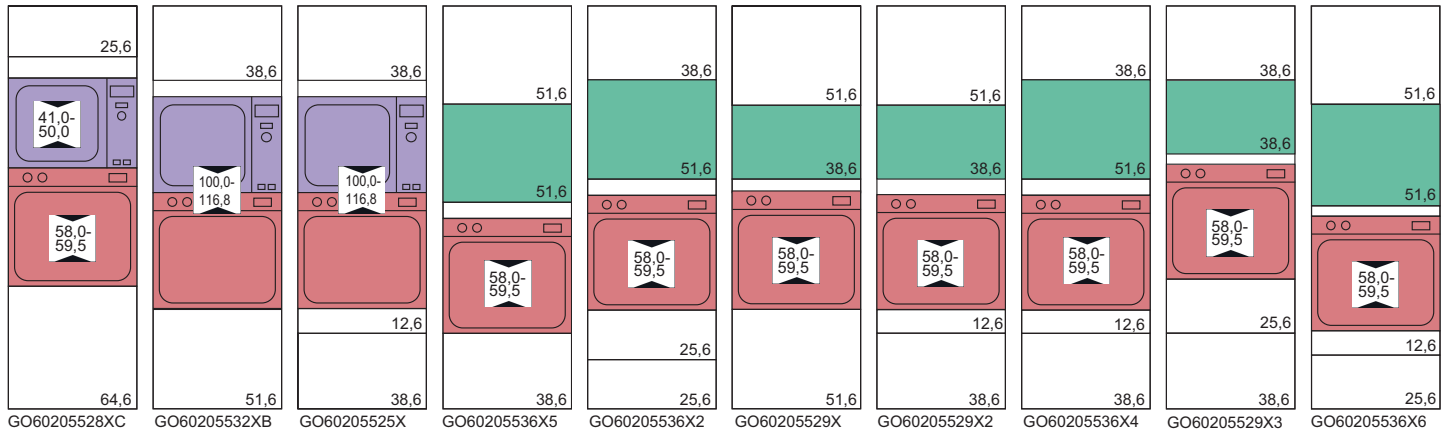
**AN..85552**

Unit widths:  
60

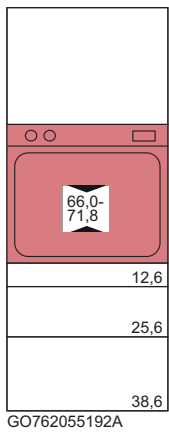
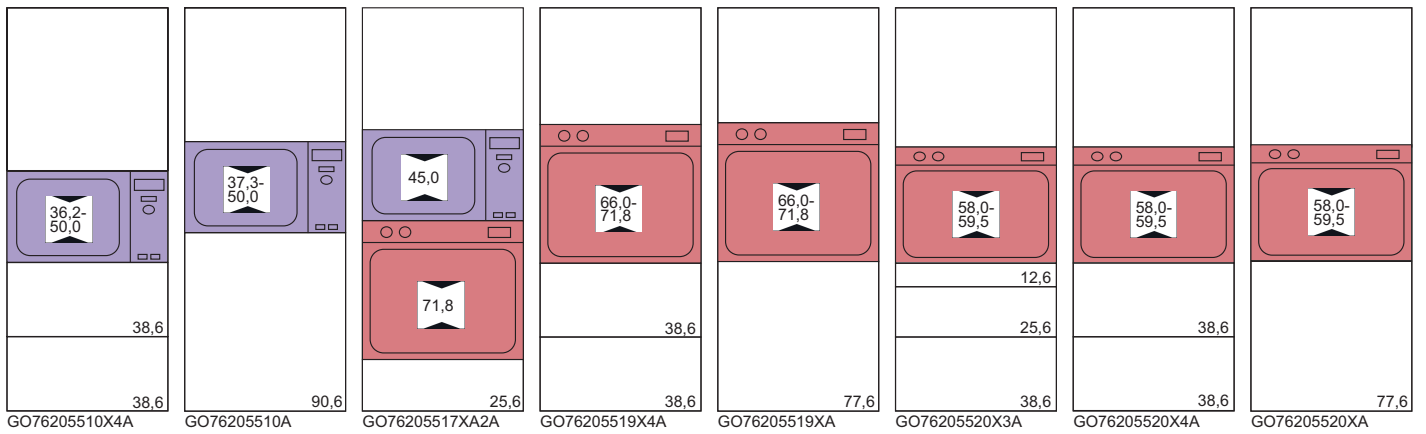
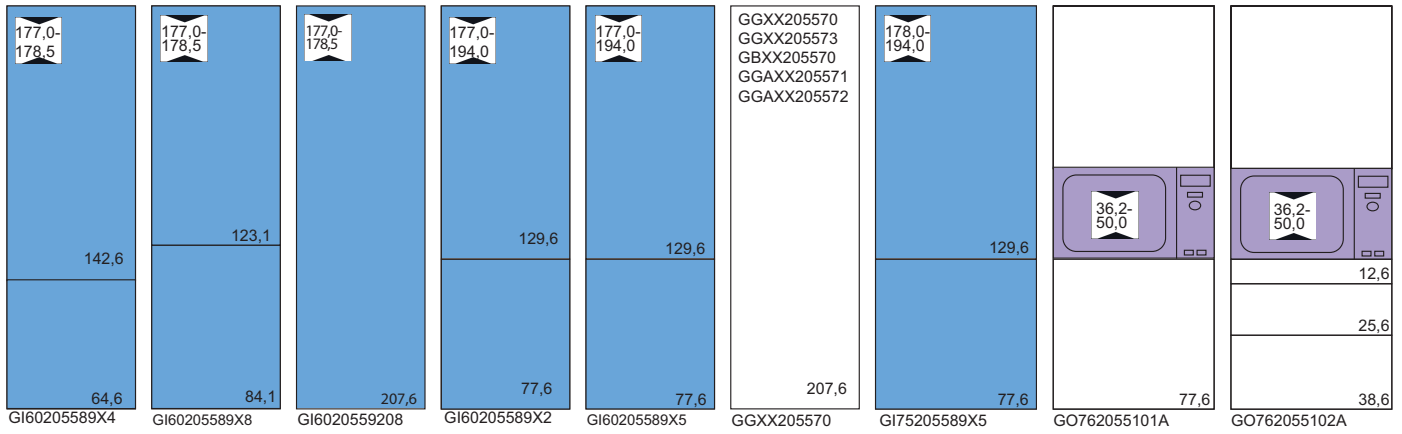
# Recess overview Tall units 207.8 cm



# Recess overview Tall units 207.8 cm



# Recess overview Tall units 207.8 cm




# Tall units 207.8 cm high


Carcase depth 55.5 cm (standard)


- = Models also available in 34/45.5/61 cm carcass depth (Order no.: ... replace ... 55 ... with 34/45/61)
- = Models also available in 45.5/61 cm carcass depth (order no.: replace ... 55 ... with 45/61)
- ▲ = Types also available with 61 cm carcass depth (order no. ... replace ... 55 ... with 61)

Order no.  
W H D


Hinge side:	Carcass depth	Price groups								
		1	2	3	4	5	6	7	8	9
R/L	■	563	576	630	770	825	855	920	1012	-
R/L	■	563	576	630	770	825	855	920	1012	-
R/L	▲	1339	1355	1402	1519	1572	1602	1662	1828	-
R/L	▲	1339	1355	1402	1519	1572	1602	1662	1828	-
	▲	932	964	979	1163	1217	1260	1347	1482	-
	▲	943	971	1034	1217	1287	1315	1410	1551	-
	▲	932	964	979	1163	1217	1260	1347	1482	-
	▲	962	987	1034	1217	1287	1315	1410	1551	-
	▲	1014	1043	1062	1244	1296	1342	1430	1573	-
	▲	1042	1068	1114	1296	1366	1396	1491	1640	-
Width 30, 45 Not available for: ALUELEMENTS, ATLANTA-B, ATLANTA-S, BERGEN, CASTELLO, CHALET-B, CHALET-S, CHICAGO, FRAME, GARDA, LUGANO, LUX-B, MIAMI, MODENA, MUNICH, NEVADA, NOBEL-B, NOBEL-S, ORLANDO-B, ORLANDO-S, OSLO 15, PADUA, SOFIE-B, SOFIE-S, TESSIN 15, TIM 15, TREND, VINO, VIVA, YORK-B, YORK-S										
	▲	1141	1170	1188	1365	1418	1464	1553	1708	-
	▲	1163	1190	1236	1413	1484	1513	1609	1770	-
	▲	1141	1170	1188	1365	1418	1464	1553	1708	-
	▲	1163	1190	1236	1413	1484	1513	1609	1770	-
	▲	1222	1251	1270	1448	1501	1547	1633	1796	-
	▲	1244	1272	1319	1496	1565	1595	1689	1858	-
Width 30, 45 Not available for: ALUELEMENTS, ATLANTA-B, ATLANTA-S, BERGEN, CASTELLO, CHALET-B, CHALET-S, CHICAGO, FRAME, GARDA, LUGANO, LUX-B, MIAMI, MODENA, MUNICH, NEVADA, NOBEL-B, NOBEL-S, ORLANDO-B, ORLANDO-S, OSLO 15, PADUA, SOFIE-B, SOFIE-S, TESSIN 15, TIM 15, TREND, VINO, VIVA, YORK-B, YORK-S										
R/L	▲	1973	1986	2037	2131	2175	2204	2266	2493	-
R/L	▲	2100	2115	2171	2318	2400	2408	2479	2727	-


**1426 646**  **Crockery cupboard angled 37.2°**  
 1 door 142.6 cm  
 1 door 64.6 cm  
 1 fixed shelf  
 6 adjustable shelves  
 For adjacent fitting left or right


**1296 776**  **Crockery cupboard angled 37.2°**  
 1 door 129.6 cm  
 1 door 77.6 cm  
 1 fixed shelf  
 6 adjustable shelves  
 For adjacent fitting left or right


**1296 776**  **Larder unit angled 37.2°**  
 1 door 129.6 cm connected to 1 door 77.6 cm  
 1 pull-out element  
 6 adjustable wooden shelves with chrome-plated square rail  
 For adjacent fitting left or right


**1296 776**  **Larder unit angled 37.2°**  
 1 door 129.6 cm connected to 1 door 77.6 cm  
 1 pull-out element  
 6 adjustable wooden shelves with chrome-plated square rail  
 For adjacent fitting left or right


**1426 646**  **Larder unit**  
 1 pull-out  
 1 door 142.6 cm connected to 1 door 64.6 cm on telescopic rails, full height can be pulled out  
 With 6 adjustable wire baskets (chrome-plated)


**1296 776**  **Larder unit**  
 1 pull-out  
 1 door 129.6 cm connected to 1 door 77.6 cm on telescopic rails, full height can be pulled out  
 With 6 adjustable wire baskets (chrome-plated)

**2076**  **Larder unit**  
 1 pull-out 207.6 cm on telescopic rails  
 Full height can be pulled out  
 With 6 adjustable wire baskets (chrome-plated)

**1426 646**  **Larder unit**  
 1 pull-out  
 1 door 142.6 cm connected to 1 door 64.6 cm on telescopic rails, full height can be pulled out  
 With 6 adjustable wooden shelves with chrome-plated, square rail

**1296 776**  **Larder unit**  
 1 pull-out  
 1 door 129.6 cm connected to 1 door 77.6 cm on telescopic rails  
 Full height can be pulled out  
 With 6 adjustable wooden shelves with chrome-plated, square rail

**2076**  **Larder unit**  
 1 pull-out 207.6 cm on telescopic rails Full height can be pulled out  
 With 6 adjustable wooden shelves with chrome-plated, square rail

**1296 776**  **Larder unit**  
 1 door 129.6 cm connected to 1 door 77.6 cm  
 1 fixed shelf  
 1 swivel and pull-out element  
 6 adjustable and  
 6 adjustable wooden shelves with chrome-plated square rail  
 Open top compartment 18.1 cm

# Tall units 207.8 cm high

Carcase depth 55.5 cm (standard)

■ = Models also available in 34/45.5/61 cm carcass depth (Order no.: ... replace ... 55 ... with 34/45/61)  
 □ = Models also available in 45.5/61 cm carcass depth (order no.: replace ... 55 ... with 45/61)  
 ▲ = Types also available with 61 cm carcass depth (order no.: ... replace ... 55 ... with 61)

Order no.  
W H D

Hinge side:	Carcass depth	Price groups									
		1	2	3	4	5	6	7	8	9	
		▲	3933	3961	4065	4247	4339	4397	4519	4971	-
R/L	▲		1595	1609	1660	1761	1806	1835	1895	2085	-
R/L	▲		1698	1713	1768	1925	1981	2015	2087	2296	-
R/L	▲		1595	1609	1660	1761	1806	1835	1895	2085	-
R/L	▲		1698	1713	1768	1925	1981	2015	2087	2296	-
R/L	▲		1543	1556	1619	1839	1898	1935	2009	2210	-
R/L	▲		888	904	953	1141	1187	1216	1275	1403	-
R/L	▲		951	970	1024	1262	1319	1352	1425	1568	-
R/L	▲		940	956	1004	1194	1239	1268	1327	1460	-
R/L	▲		1002	1020	1074	1313	1368	1403	1474	1621	-
R/L	■		371	384	440	582	641	666	732	805	-
R/L	■		371	384	440	582	641	666	732	805	-
R/L	■		371	384	440	582	641	666	732	805	-
R/L	■		371	384	440	633	684	713	778	856	-
R/L	■		412	424	487	736	793	830	905	996	-
R/L	■		848	860	916	1058	1115	1142	1207	1328	-
R/L	■		848	860	916	1058	1115	1142	1207	1328	-
R/L	■		848	860	916	1058	1115	1142	1207	1328	-
R/L	■		848	860	916	1109	1158	1189	1254	1379	-
R/L	■		887	901	964	1212	1270	1306	1382	1520	-
R/L	■		703	717	772	913	972	997	1064	1170	-
R/L	■		703	717	772	913	972	997	1064	1170	-
R/L	■		703	717	772	913	972	997	1064	1170	-
R/L	■		703	717	772	966	1014	1045	1110	1221	-
R/L	■		743	758	818	1067	1127	1161	1236	1360	-
R/L	■		371	384	440	582	641	666	732	805	-
R/L	■		371	384	440	582	641	666	732	805	-
R/L	■		371	384	440	582	641	666	732	805	-
R/L	■		371	384	440	633	684	713	778	856	-
R/L	■		412	424	487	736	793	830	905	996	-
R/L	■		371	384	440	582	641	666	732	805	-
R/L	■		371	384	440	582	641	666	732	805	-
R/L	■		371	384	440	582	641	666	732	805	-
R/L	■		371	384	440	633	684	713	778	856	-
R/L	■		412	424	487	736	793	830	905	996	-

78

78

78

78

78

78

71,5

NEW

78



The adjustable shelves will be delivered as a separate package.



The adjustable shelves will be delivered as a separate package.



Width 30, 40, 45, 50, 60 Not available for: MIAMI, VIVA

# Tall units 207.8 cm high

Carcase depth 55.5 cm (standard)

■ = Models also available in 34/45.5/61 cm carcass depth (Order no.: ... replace ... 55 ... with 34/45/61)  
 □ = Models also available in 45.5/61 cm carcass depth (order no.: replace ... 55 ... with 45/61)  
 ▲ = Types also available with 61 cm carcass depth (order no. ... replace ... 55 ... with 61)

Order no.  
 W H D

Hinge side:	Carcass depth	Price groups											
		1	2	3	4	5	6	7	8	9			
■	55.5	78	GG 80 20 55 01	■	851	883	983	1131	1206	1257	1365	1502	-
			GG 90 20 55 01	■	851	883	983	1131	1206	1257	1365	1502	-
R/L	55.5	78	GGA 30 20 55 08	■	727	740	796	938	997	1022	1088	1197	-
			GGA 40 20 55 08	■	727	740	796	938	997	1022	1088	1197	-
			GGA 45 20 55 08	■	727	740	796	938	997	1022	1088	1197	-
			GGA 50 20 55 08	■	727	740	796	989	1040	1069	1134	1247	-
			GGA 60 20 55 08	■	758	770	831	1092	1149	1186	1261	1387	-
NEW													
R/L	55.5	78	GG 30 20 55 73	■	717	730	785	926	985	1012	1077	1185	-
			GG 40 20 55 73	■	717	730	785	926	985	1012	1077	1185	-
			GG 45 20 55 73	■	717	730	785	926	985	1012	1077	1185	-
			GG 50 20 55 73	■	717	730	785	977	1027	1059	1125	1238	-
			GG 60 20 55 73	■	758	770	831	1080	1138	1176	1251	1376	-
NEW													
R/L	55.5	78	GGA 30 20 55 01	■	1012	1025	1079	1207	1267	1291	1356	1492	-
			GGA 40 20 55 01	■	1052	1066	1120	1248	1304	1332	1396	1536	-
			GGA 45 20 55 01	■	1052	1066	1120	1248	1304	1332	1396	1536	-
			GGA 50 20 55 01	■	1067	1080	1135	1312	1360	1393	1458	1604	-
			GGA 60 20 55 01	■	1128	1140	1201	1434	1494	1529	1603	1763	-
NEW													
R/L	55.5	78	GGA 30 20 55 02	■	1020	1034	1088	1217	1274	1299	1364	1500	-
			GGA 40 20 55 02	■	1061	1073	1129	1254	1312	1339	1403	1543	-
			GGA 45 20 55 02	■	1061	1073	1129	1254	1312	1339	1403	1543	-
			GGA 50 20 55 02	■	1074	1088	1142	1320	1368	1399	1464	1610	-
			GGA 60 20 55 02	■	1135	1148	1211	1442	1501	1538	1612	1773	-
NEW													
■	55.5	78	GGA 90 20 55 03	■	1681	1707	1815	2082	2195	2247	2378	2616	-
■	38.6	78	GGA 90 20 55 02	■	1441	1487	1675	1926	2003	2109	2318	2550	-
			GGA 100 20 55 02	■	1441	1487	1675	1926	2003	2109	2318	2550	-
R/L	55.5	84,5	GG 30 20 55 05	■	371	384	440	582	641	666	732	805	-
			GG 40 20 55 05	■	371	384	440	582	641	666	732	805	-
			GG 45 20 55 05	■	371	384	440	582	641	666	732	805	-
			GG 50 20 55 05	■	371	384	440	633	684	713	778	856	-
			GG 60 20 55 05	■	412	424	487	736	793	830	905	996	-
Width 30, 40, 45, 50, 60 Not available for: MIAMI, VIVA													
R/L	55.5	84,5	GGA 30 20 55 081	■	727	740	796	938	997	1022	1088	1197	-
			GGA 40 20 55 081	■	727	740	796	938	997	1022	1088	1197	-
			GGA 45 20 55 081	■	727	740	796	938	997	1022	1088	1197	-
			GGA 50 20 55 081	■	727	740	796	989	1040	1069	1134	1247	-
			GGA 60 20 55 081	■	758	770	831	1092	1149	1186	1261	1387	-
NEW													
Width 30, 40, 45, 50, 60 Not available for: MIAMI, VIVA													



# Tall units 207.8 cm high

Carcase depth 55.5 cm (standard)

■ = Models also available in 34/45.5/61 cm carcass depth (Order no.: ... replace ... 55 ... with 34/45/61)  
 □ = Models also available in 45.5/61 cm carcass depth (order no.: replace ... 55 ... with 45/61)  
 ▲ = Types also available with 61 cm carcass depth (order no.: ... replace ... 55 ... with 61)

Order no.  
W H D

Hinge side:	Carcass depth	Price groups									
		1	2	3	4	5	6	7	8	9	
R/L ■	84,5	<b>GGA 30 20 55 06</b>	1012	1025	1079	1207	1267	1291	1356	1492	-
		<b>GGA 40 20 55 06</b>	1052	1066	1120	1248	1304	1332	1396	1536	-
		<b>GGA 45 20 55 06</b>	1052	1066	1120	1248	1304	1332	1396	1536	-
		<b>GGA 50 20 55 06</b>	1067	1080	1135	1312	1360	1393	1458	1604	-
		<b>GGA 60 20 55 06</b>	1128	1140	1201	1434	1494	1529	1603	1763	-
Width 30, 40, 45, 50, 60 Not available for: MIAMI, VIVA											
R/L ■	646 1426	<b>GG 30 20 55 021</b>	371	384	440	582	641	666	732	805	-
		<b>GG 40 20 55 021</b>	371	384	440	582	641	666	732	805	-
		<b>GG 45 20 55 021</b>	371	384	440	582	641	666	732	805	-
		<b>GG 50 20 55 021</b>	371	384	440	633	684	713	778	856	-
		<b>GG 60 20 55 021</b>	412	424	487	736	793	830	905	996	-
R/L ■	2076	<b>GG 30 20 55 70</b>	451	466	523	663	721	747	813	894	-
		<b>GG 40 20 55 70</b>	451	466	523	663	721	747	813	894	-
		<b>GG 45 20 55 70</b>	451	466	523	663	721	747	813	894	-
		<b>GG 50 20 55 70</b>	451	466	523	713	764	794	859	945	-
		<b>GG 60 20 55 70</b>	492	505	568	816	873	911	986	1085	-
Width 30, 40, 45, 50, 60 Not available for: ALUELEMENTS, ATLANTA-B, ATLANTA-S, BERGEN, CASTELLO, CHALET-B, CHALET-S, CHICAGO, FRAME, GARDA, LUGANO, LUX-B, MIAMI, MODENA, MUNICH, NEVADA, NOBEL-B, NOBEL-S, ORLANDO-B, ORLANDO-S, OSLO 15, PADUA, SOFIE-B, SOFIE-S, TESSIN 15, TIM 15, TREND, VINO, VIVA, YORK-B, YORK-S											
Each front has a tightening fitting Ranges without fitting: SMARTGLAS, NOBEL, SOFIE, YORK, LUGANO, TALEA, RIVA, GARDA, ATLANTA, ORLANDO, CHICAGO without tightening fitting											
R/L ■	2076	<b>GGA 30 20 55 71</b>	1092	1107	1160	1289	1346	1373	1437	1581	-
		<b>GGA 40 20 55 71</b>	1092	1107	1160	1289	1346	1373	1437	1581	-
		<b>GGA 45 20 55 71</b>	1133	1147	1201	1328	1386	1412	1477	1625	-
		<b>GGA 50 20 55 71</b>	1148	1161	1217	1393	1442	1473	1538	1692	-
		<b>GGA 60 20 55 71</b>	1207	1221	1282	1514	1573	1611	1684	1852	-
Width 30, 40, 45, 50, 60 Not available for: ALUELEMENTS, ATLANTA-B, ATLANTA-S, BERGEN, CASTELLO, CHALET-B, CHALET-S, CHICAGO, FRAME, GARDA, LUGANO, LUX-B, MIAMI, MODENA, MUNICH, NEVADA, NOBEL-B, NOBEL-S, ORLANDO-B, ORLANDO-S, OSLO 15, PADUA, SOFIE-B, SOFIE-S, TESSIN 15, TIM 15, TREND, VINO, VIVA, YORK-B, YORK-S											
Each front has a tightening fitting Ranges without fitting: SMARTGLAS, NOBEL, SOFIE, YORK, LUGANO, TALEA, RIVA, GARDA, ATLANTA, ORLANDO, CHICAGO without tightening fitting											
R/L ■	2076	<b>GGA 30 20 55 72</b>	1101	1114	1170	1296	1355	1382	1445	1590	-
		<b>GGA 40 20 55 72</b>	1101	1114	1170	1296	1355	1382	1445	1590	-
		<b>GGA 45 20 55 72</b>	1141	1153	1208	1336	1393	1418	1485	1634	-
		<b>GGA 50 20 55 72</b>	1154	1170	1223	1399	1451	1481	1547	1702	-
		<b>GGA 60 20 55 72</b>	1217	1229	1291	1523	1580	1620	1692	1861	-
Width 30, 40, 45, 50, 60 Not available for: ALUELEMENTS, ATLANTA-B, ATLANTA-S, BERGEN, CASTELLO, CHALET-B, CHALET-S, CHICAGO, FRAME, GARDA, LUGANO, LUX-B, MIAMI, MODENA, MUNICH, NEVADA, NOBEL-B, NOBEL-S, ORLANDO-B, ORLANDO-S, OSLO 15, PADUA, SOFIE-B, SOFIE-S, TESSIN 15, TIM 15, TREND, VINO, VIVA, YORK-B, YORK-S											
Each front has a tightening fitting Ranges without fitting: SMARTGLAS, NOBEL, SOFIE, YORK, LUGANO, TALEA, RIVA, GARDA, ATLANTA, ORLANDO, CHICAGO without tightening fitting											
R/L □	1426 646	<b>GB 30 20 55 02</b>	371	384	440	582	641	666	732	805	-
		<b>GB 40 20 55 02</b>	371	384	440	582	641	666	732	805	-
		<b>GB 45 20 55 02</b>	371	384	440	582	641	666	732	805	-
		<b>GB 50 20 55 02</b>	371	384	440	633	684	713	778	856	-
		<b>GB 60 20 55 02</b>	412	424	487	736	793	830	905	996	-
R/L □	1296 776	<b>GB 30 20 55 01</b>	371	384	440	582	641	666	732	805	-
		<b>GB 40 20 55 01</b>	371	384	440	582	641	666	732	805	-
		<b>GB 45 20 55 01</b>	371	384	440	582	641	666	732	805	-
		<b>GB 50 20 55 01</b>	371	384	440	633	684	713	778	856	-
		<b>GB 60 20 55 01</b>	412	424	487	736	793	830	905	996	-
R/L □	646 1426	<b>GB 30 20 55 021</b>	371	384	440	582	641	666	732	805	-
		<b>GB 40 20 55 021</b>	371	384	440	582	641	666	732	805	-
		<b>GB 45 20 55 021</b>	371	384	440	582	641	666	732	805	-
		<b>GB 50 20 55 021</b>	371	384	440	633	684	713	778	856	-
		<b>GB 60 20 55 021</b>	412	424	487	736	793	830	905	996	-

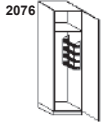
# Tall units 207.8 cm high

Carcase depth 55.5 cm (standard)

■ = Models also available in 34/45.5/61 cm carcass depth (Order no.: ... replace ... 55 ... with 34/45/61)  
 □ = Models also available in 45.5/61 cm carcass depth (order no.: replace ... 55 ... with 45/61)  
 ▲ = Types also available with 61 cm carcass depth (order no. ... replace ... 55 ... with 61)

Order no.  
 W H D

Hinge side:	Carcass depth	Price groups									
		1	2	3	4	5	6	7	8	9	
R/L □	55.5	GB 30 20 55 70	451	466	523	663	721	747	813	894	-
		GB 40 20 55 70	451	466	523	663	721	747	813	894	-
		GB 45 20 55 70	451	466	523	663	721	747	813	894	-
		GB 50 20 55 70	451	466	523	713	764	794	859	945	-
		GB 60 20 55 70	492	505	568	816	873	911	986	1085	-
<b>Width 30, 40, 45, 50, 60 Not available for:</b> ALUELEMENTS, ATLANTA-B, ATLANTA-S, BERGEN, CASTELLO, CHALET-B, CHALET-S, CHICAGO, FRAME, GARDA, LUGANO, LUX-B, MIAMI, MODENA, MUNICH, NEVADA, NOBEL-B, NOBEL-S, ORLANDO-B, ORLANDO-S, OSLO 15, PADUA, SOFIE-B, SOFIE-S, TESSIN 15, TIM 15, TREND, VINO, VIVA, YORK-B, YORK-S Each front has a tightening fitting Ranges without fitting: SMARTGLAS, NOBEL, SOFIE, YORK, LUGANO, TALEA, RIVA, GARDA, ATLANTA, ORLANDO, CHICAGO without tightening fitting											
R/L ▲	61	GB 40 20 55 12	558	570	626	769	828	852	919	1011	-
		GB 45 20 55 12	558	570	626	769	828	852	919	1011	-
		GB 50 20 55 12	558	570	626	819	870	900	965	1062	-
		GB 60 20 55 12	599	611	673	922	979	1017	1092	1201	-
<b>Optional accessories</b> HW HS Holder for vacuum cleaner hose or PET storage pocket (for screwing on), anthracite HW UTB Utensils box, e.g. for storing towels, cleaning cloths, etc. (for screwing on), anthracite											
R/L ▲	78	GB 40 20 55 11	558	570	626	769	828	852	919	1011	-
		GB 45 20 55 11	558	570	626	769	828	852	919	1011	-
		GB 50 20 55 11	558	570	626	819	870	900	965	1062	-
		GB 60 20 55 11	599	611	673	922	979	1017	1092	1201	-
<b>Optional accessories</b> HW HS Holder for vacuum cleaner hose or PET storage pocket (for screwing on), anthracite HW UTB Utensils box, e.g. for storing towels, cleaning cloths, etc. (for screwing on), anthracite											
R/L ▲	61	GB 40 20 55 031	558	570	626	769	828	852	919	1011	-
		GB 45 20 55 031	558	570	626	769	828	852	919	1011	-
		GB 50 20 55 031	558	570	626	819	870	900	965	1062	-
		GB 60 20 55 031	599	611	673	922	979	1017	1092	1201	-
<b>Optional accessories</b> HW HS Holder for vacuum cleaner hose or PET storage pocket (for screwing on), anthracite HW UTB Utensils box, e.g. for storing towels, cleaning cloths, etc. (for screwing on), anthracite											
R/L ▲	61	GB 40 20 55 71	638	653	709	849	907	934	1000	1100	-
		GB 45 20 55 71	638	653	709	849	907	934	1000	1100	-
		GB 50 20 55 71	638	653	709	900	951	981	1045	1150	-
		GB 60 20 55 71	678	691	755	1003	1060	1097	1172	1289	-
<b>Width 40, 45, 50, 60 Not available for:</b> ALUELEMENTS, ATLANTA-B, ATLANTA-S, BERGEN, CASTELLO, CHALET-B, CHALET-S, CHICAGO, FRAME, GARDA, LUGANO, LUX-B, MIAMI, MODENA, MUNICH, NEVADA, NOBEL-B, NOBEL-S, ORLANDO-B, ORLANDO-S, OSLO 15, PADUA, SOFIE-B, SOFIE-S, TESSIN 15, TIM 15, TREND, VINO, VIVA, YORK-B, YORK-S <b>Optional accessories</b> HW HS Holder for vacuum cleaner hose or PET storage pocket (for screwing on), anthracite HW UTB Utensils box, e.g. for storing towels, cleaning cloths, etc. (for screwing on), anthracite Each front has a tightening fitting Ranges without fitting: SMARTGLAS, NOBEL, SOFIE, YORK, LUGANO, TALEA, RIVA, GARDA, ATLANTA, ORLANDO, CHICAGO without tightening fitting											
R/L	61,0	GK 45 20 61 70	711	738	759	885	977	1027	1103	1211	-
		GK 50 20 61 70	723	748	770	897	989	1039	1114	1223	-
		GK 60 20 61 70	734	760	783	909	999	1050	1127	1238	-
<b>Width 45, 50, 60 Not available for:</b> ALUELEMENTS, ATLANTA-B, ATLANTA-S, BERGEN, CASTELLO, CHALET-B, CHALET-S, CHICAGO, FRAME, GARDA, LUGANO, LUX-B, MIAMI, MODENA, MUNICH, NEVADA, NOBEL-B, NOBEL-S, ORLANDO-B, ORLANDO-S, OSLO 15, PADUA, SOFIE-B, SOFIE-S, TESSIN 15, TIM 15, TREND, VINO, VIVA, YORK-B, YORK-S Each front has a tightening fitting Ranges without fitting: SMARTGLAS, NOBEL, SOFIE, YORK, LUGANO, TALEA, RIVA, GARDA, ATLANTA, ORLANDO, CHICAGO without tightening fitting											
R/L	61,0	GK 90 20 61 70	1406	1458	1501	1755	1937	2037	2189	2405	-
		GK 100 20 61 70	1428	1481	1525	1778	1958	2061	2212	2431	-
<b>Width 90, 100 Not available for:</b> ALUELEMENTS, ATLANTA-B, ATLANTA-S, BERGEN, CASTELLO, CHALET-B, CHALET-S, CHICAGO, FRAME, GARDA, LUGANO, LUX-B, MIAMI, MODENA, MUNICH, NEVADA, NOBEL-B, NOBEL-S, ORLANDO-B, ORLANDO-S, OSLO 15, PADUA, SOFIE-B, SOFIE-S, TESSIN 15, TIM 15, TREND, VINO, VIVA, YORK-B, YORK-S Each front has a tightening fitting Ranges without fitting: SMARTGLAS, NOBEL, SOFIE, YORK, LUGANO, TALEA, RIVA, GARDA, ATLANTA, ORLANDO, CHICAGO without tightening fitting											



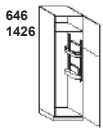
**Broom cupboard**  
 1 door 207.6 cm  
 1 fixed shelf  
 1 hook rail  
 1 storage basket



**Broom cupboard**  
 1 door 142.6 cm connected to 1 door 64.6 cm  
 1 fixed shelf  
 1 hook rail with 5 hooks, anthracite  
 Modular interior partitioning system, consisting of:  
 1 set of attachment rails, anthracite  
 1 large 3-side tray with rail, anthracite  
 1 carrier box for cleaning materials with carrier rails, anthracite  
 1 hook rail with 5 hooks, anthracite



**Broom cupboard**  
 1 door 129.6 cm connected to 1 door 77.6 cm  
 1 fixed shelf  
 1 hook rail with 5 hooks, anthracite  
 Modular interior partitioning system, consisting of:  
 1 set of attachment rails, anthracite  
 1 large 3-side tray with rail, anthracite  
 1 carrier box for cleaning materials with carrier rails, anthracite  
 1 hook rail with 5 hooks, anthracite



**Broom cupboard**  
 1 door 64.6 cm connected to 1 door 142.6 cm  
 1 fixed shelf  
 1 hook rail with 5 hooks, anthracite  
 Modular interior partitioning system, consisting of:  
 1 set of attachment rails, anthracite  
 1 large 3-side tray with rail, anthracite  
 1 carrier box for cleaning materials with carrier rails, anthracite  
 1 hook rail with 5 hooks, anthracite



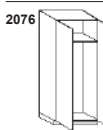
**Broom cupboard**  
 1 door 207.6 cm  
 1 fixed shelf  
 1 hook rail with 5 hooks, anthracite  
 Modular interior partitioning system, consisting of:  
 1 set of attachment rails, anthracite  
 1 large 3-side tray with rail, anthracite  
 1 carrier box for cleaning materials with carrier rails, anthracite  
 1 hook rail with 5 hooks, anthracite



**Hall cupboard / coat stand**  
 1 door 207.6 cm  
 1 fixed shelf  
 1 garment rail at a height of 156 cm plus plinth height



Carcass depth 61 cm  
 Usable inside depth 58.5 cm



**Hall cupboard / coat stand**  
 2 doors 207.6 cm  
 1 fixed shelf  
 1 garment rail at a height of 156 cm plus plinth height



Carcass depth 61 cm  
 Usable inside depth 58.5 cm

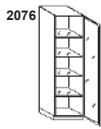
# Tall units 207.8 cm high with glass fronts

Carcase depth 55.5 cm (standard)

		Glass groups									
		G1	G2	G2S	G5S	G6					
Hinge side:	Carcase depth										

■ = Models also available in 34/45.5/61 cm carcuse depth (Order no.: ... replace ... 55 ... with 34/45/61)

Order no.  
W H D



**Crockery cupboard with glass front**  
-neutral-  
1 glass door 207.6 cm  
4 adjustable glass shelves  
and 1 additional adjustable glass shelf  
for individual positioning

<b>GGGD 45 20 55 70</b>	R/L	■	-	-	1096	1282	1480			
<b>GGGD 50 20 55 70</b>	R/L	■	-	-	1116	1306	1500			
<b>GGGD 60 20 55 70</b>	R/L	■	-	-	1144	1339	1528			

G 1		G 2		G 2S	
<b>G1 AKTIVglass frame</b> 991 Matt glass 992 Translucent black glass		<b>G2 Design front</b> 925 Frame White Agate/Matt glass 935 Premium W. Frame/Matt Glass 940 Macaron Col. Frame/Matt Glass 95 Light grey frame/matt glass 96 Silver Col. Frame/Matt Glass 960 Snow White Frame/Matt Glass 97 Black frame/black glass		<b>G2S aluminium, framed glass door</b> 988 aluminium black, Linea glass 994 Aluminium frame/clear glass 995 aluminium frame/black glass	
G 5		G 5S		G 6	
		G5S aluminium, door with mullion 996 Alum.frame/clear gl./cross bar		<b>G6 NEW SALON</b> 986 aluminium black, black glass 987 aluminium black, clear glass 989 aluminium matt, bronze-coloured black glass 990 aluminium matt, bronze-coloured clear glass	

## Additional equipment

		Decor groups									
		M10	M20	M30	M40	M50	M60	M70	M80	M90	
Hinge side:	Carcase depth										

Order no.  
W H D




**Surcharge for tall cabinets with glass fronts inside and exterior in the same design**  
available in decor groups:  
S/B/H/MP/F/Z

<b>IDF-G</b>		-	-	-	-	1646	-	1646	1646	-
--------------	--	---	---	---	---	------	---	------	------	---

M 10	M 20	M 30	M 40	M 50
K M10 laminate				B M50 Velvet lacquer S M50 microstructure lacquer
M 60	M 70	M 80	M 90	
	F M70 veneer / oak / walnut Z M70 Veneer / Bavaria	H M80 high gloss-Lacquer MP M80 laqué mat Premium		

# Tall units 207.8 cm high with roller shutter

The useable inside depth (bare dimension) for the following carcass depths is  
 36.1 cm – bare dimension 26.5 cm / 47.7 cm – bare dimension 38.1 cm  
 57.7 cm – bare dimension 48.1 cm / 63.2 cm – bare dimension 53.6 cm  
 ▲ = Types also available with 63.2 cm carcass depth (order no. ... replace ... 58 ... with 63)

	Order no.	W	H	D	Hinge side:	Carcass depth	Decor groups								
							M10	M20	M30	M40	M50	M60	M70	M80	M90
 <p><b>Tall unit with roller shutter 207,8 cm high</b>                      Roller shutter stainless steel decor                      6 adjustable shelves                      1 structural shelf                      3 sockets</p>	<b>GJG 60 20 58 77</b>				▲	1754	-	-	-	4132	-	4893	-	-	
	optional accessory: only TAB-A**45 can be used as a pull-out shelf, and only 577 mm deep No visible sides possible in other decor groups														
<p><b>as above, but Tall unit with roller shutter 207,8 cm high 47,7 cm deep</b></p>	<b>GJG 60 20 48 77</b>					1711	-	-	-	3818	-	4475	-	-	
	No visible sides possible in other decor groups														
 <p><b>Tall unit with roller shutter 207,8 cm high</b>                      Roller shutters black laminate                      6 adjustable shelves                      1 structural shelf                      3 sockets</p>	<b>GJG 60 20 58 78</b>				▲	1878	-	-	-	4255	-	5016	-	-	
	optional accessory: only TAB-A**45 can be used as a pull-out shelf, and only 577 mm deep No visible sides possible in other decor groups														
<p><b>as above, but Tall unit with roller shutter 207,8 cm high 47,7 cm deep</b></p>	<b>GJG 60 20 48 78</b>					1835	-	-	-	3941	-	4599	-	-	
	No visible sides possible in other decor groups														
 <p><b>Tall unit SMARTGLAS roller shutters 207,8 cm high</b>                      6 adjustable shelves                      1 structural shelf                      3 sockets</p>	<b>GJSGG 60 20 58</b>				▲	3572	-	-	-	5950	-	6711	-	-	
	Panel, guide profile and handle in the same colour as the roller shutter optional accessory: only TAB-A**45 can be used as a pull-out shelf, and only 577 mm deep No visible sides possible in other decor groups														
<p><b>as above, but Tall unit SMARTGLAS roller shutters 207,8 cm high 47,7 cm deep</b></p>	<b>GJSGG 60 20 48</b>					3529	-	-	-	5636	-	6293	-	-	

M 10	M 20	M 30	M 40	M 50
K M10 laminate				B M50 Velvet Lacquer S Microstructur lacquer
M 60	M 70	M 80	M 90	
	F M70 veneer / oak / walnut Z M70 Veneer / Bavaria			












**Pull-out shelf with guide rails**  
 With locking function, full pull-out  
 „push to open“, shelf from decor group K  
 For carcass width 45 cm, 50 cm, 60 cm  
 For carcass width 80 cm, 90 cm  
 for carcass depths 45.5 cm and 55.5 cm

Load-bearing capacity depth 55.5 cm: 35 kg  
 Load-bearing capacity depth 45.5 cm: 35 kg  
 Load-bearing capacity depth 55.5 cm: 35 kg  
 Load-bearing capacity depth 45.5 cm: 35 kg  
 Load-bearing capacity depth 55.5 cm: 35 kg  
 Load-bearing capacity depth 45.5 cm: 35 kg  
 Load-bearing capacity depth 55.5 cm: 30 kg  
 Load-bearing capacity depth 45.5 cm: 30 kg  
 Load-bearing capacity depth 55.5 cm: 30 kg  
 Load-bearing capacity depth 45.5 cm: 30 kg

	Important:									
		M10	M20	M30	M40	M50	M60	M70	M80	M90
	When installing in units with hinged doors always take wide angle hinges SA-90155E3 into consideration.									
<b>TAB-AZ45 55</b>		220	-	-	-	-	-	-	-	-
<b>TAB-AZ45 45</b>		220	-	-	-	-	-	-	-	-
<b>TAB-AZ50 55</b>		225	-	-	-	-	-	-	-	-
<b>TAB-AZ50 45</b>		225	-	-	-	-	-	-	-	-
<b>TAB-AZ60 55</b>		234	-	-	-	-	-	-	-	-
<b>TAB-AZ60 45</b>		234	-	-	-	-	-	-	-	-
<b>TAB-AZ80 55</b>		282	-	-	-	-	-	-	-	-
<b>TAB-AZ80 45</b>		282	-	-	-	-	-	-	-	-
<b>TAB-AZ90 55</b>		298	-	-	-	-	-	-	-	-
<b>TAB-AZ90 45</b>		298	-	-	-	-	-	-	-	-

# Appliance unit 207.8 cm high for microwave / oven

Carcase depth 55.5 cm (standard)

					Price groups									
			Order no.	Hinge side:	Carcase depth	1	2	3	4	5	6	7	8	9
			W H D											
776 776 	<b>Appliance unit</b> 1 door 77.6 cm 2 adjustable shelves 1 panel 1 appliance aperture 36.2 - 50 cm 1 door 77.6 cm 2 adjustable shelves <b>Appliance unit with compensation door above appliance aperture</b>	36.2-50,0	GO 60 20 55 10 1	R/L ▲	▲	448	467	526	617	654	685	745	820	-
		(78)												
776 776 	<b>Appliance unit</b> 1 door 77.6 cm 2 adjustable shelves 1 panel 1 appliance aperture 36.2 - 50 cm 1 door 77.6 cm with wide angle hinges 3 internal drawers <b>Appliance unit with compensation door above appliance aperture</b>	36.2-50,0	GO 60 20 55 10 4	R/L ▲	▲	794	812	869	964	1001	1028	1090	1199	-
		(78)												
776 126 256 386 	<b>Appliance unit</b> 1 door 77.6 cm 2 adjustable shelves 1 panel 1 appliance aperture 36.2 - 50 cm 1 drawer 12.6 cm 1 pull-out 25.6 cm 1 pull-out 38.6 cm <b>Appliance unit with compensation door above appliance aperture</b>	36.2-50,0	GO 60 20 55 10 2	R/L ▲	▲	925	943	1002	1092	1131	1159	1221	1343	-
		(78)												
841 	<b>Appliance unit with compensation door above appliance aperture</b> 1 appliance aperture 36.2 - 50 cm 1 door 84.1 cm 4 adjustable shelves <b>NEW</b>	36.2-50,0	GO 60 20 55 10 8A	R/L ▲	▲	448	467	526	617	654	685	745	820	-
		(84,5)												
776 386 386 	<b>Appliance unit</b> 1 door 77.6 cm 2 adjustable shelves 1 panel 1 appliance aperture 37.2 - 50 cm 2 pull-outs 38.6 cm <b>Appliance unit with compensation door above appliance aperture</b>	37.3-50,0	GO 60 20 55 10 X4	R/L ▲	▲	838	856	915	1005	1044	1072	1134	1247	-
		(78)												
386 451 	<b>Appliance unit</b> 1 appliance aperture 37.3 - 50 cm 1 pull-out 38.6 cm 1 pull-out 45.1 cm 2 adjustable shelves	37.3-50,0	GO 60 20 55 10 X9A	R/L ▲	▲	782	801	859	940	977	1009	1071	1178	-
		(84,5)												
646 906 	<b>Appliance unit</b> 1 door 64.6 cm 1 panel 1 appliance aperture 37.3 - 50 cm 1 door 90.6 cm 5 adjustable shelves <b>Appliance unit with compensation door above appliance aperture</b>	37.3-50,0	GO 60 20 55 10	R/L ▲	▲	448	467	526	617	654	685	745	820	-
			GO 60 20 55 10 A	R/L ▲	▲	448	467	526	617	654	685	745	820	-
646 126 776 	<b>Appliance unit</b> 1 door 64.6 cm 1 panel 1 appliance aperture 37.3 - 50 cm 1 drawer 12.6 cm 1 door 77.6 cm 4 adjustable shelves <b>Appliance unit with compensation door above appliance aperture</b>	37.3-50,0	GO 60 20 55 10 5	R/L ▲	▲	595	611	668	762	799	828	890	979	-
		(78)												
646 126 386 	<b>Appliance unit</b> 1 door 64.6 cm 2 adjustable shelves 1 panel 1 appliance aperture 37.3 - 50 cm 1 drawer 12.6 cm 2 pull-outs 38.6 cm <b>Appliance unit with compensation door above appliance aperture</b>	37.3-50,0	GO 60 20 55 10 3	R/L ▲	▲	928	946	1004	1095	1133	1161	1223	1345	-
			GO 60 20 55 10 3A	R/L ▲	▲	928	946	1004	1095	1133	1161	1223	1345	-



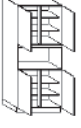





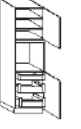

Models not available with compensation door: MIAMI, VIVA



# Appliance unit 207.8 cm high for microwave / oven

Carcase depth 55.5 cm (standard)





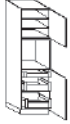
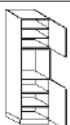


▲ = Types also available with 61 cm carcass depth (order no. ... replace ... 55 ... with 61)

				Order no.				Price groups													
				W	H	D	Hinge side:	Carcass depth	1	2	3	4	5	6	7	8	9				
776 776		<b>Appliance unit</b> 2 doors 77.6 cm 2 adjustable shelves 1 panel 1 appliance aperture 46.0 - 48.0 cm 2 doors 77.6 cm 2 adjustable shelves		46,0-48,0	GO	90	20	55	10		▲	788	819	921	1082	1144	1196	1304	1434	-	
		<b>Appliance unit with compensation door above appliance aperture</b>		78	GO	90	20	55	10	A		▲	788	819	921	1082	1144	1196	1304	1434	-
776 126 256 386		<b>Appliance unit</b> 2 doors 77.6 cm 2 adjustable shelves 1 panel 1 appliance aperture 46.0 - 48.0 cm 1 drawer 12.6 cm 1 pull-out 25.6 cm 1 pull-out 38.6 cm		46,0-48,0	GO	90	20	55	10	12		▲	1397	1443	1632	1885	1962	2065	2277	2505	-
		<b>Appliance unit with compensation door above appliance aperture</b>		78	GO	90	20	55	10	12A		▲	1397	1443	1632	1885	1962	2065	2277	2505	-
711 711		<b>Appliance unit</b> 1 door 71.1 cm 1 panel 1 appliance aperture 58.0 - 59.5 cm 1 door 71.1 cm 4 adjustable shelves		58,0-59,5	GO	60	20	55	20	9	R/L	▲	448	467	526	617	654	685	745	820	-
		<b>Appliance unit with compensation door above appliance aperture</b>		71,5	GO	60	20	55	20	9A		R/L	▲	448	467	526	617	654	685	745	820
646 776		<b>Appliance unit</b> 1 door 64.6 cm 1 panel 1 appliance aperture 58.0 - 59.5 cm 1 door 77.6 cm 4 adjustable shelves		58,0-59,5	GO	60	20	55	20	X	R/L	▲	448	467	526	617	654	685	745	820	-
		<b>Appliance unit with compensation door above appliance aperture</b>		78	GO	60	20	55	20	XA		R/L	▲	448	467	526	617	654	685	745	820
646 776		<b>Appliance unit</b> 1 door 64.6 cm 2 adjustable shelves 1 panel 1 appliance aperture 58.0 - 59.5 cm 1 door 77.6 cm 2 internal pull-outs		58,0-59,5	GO	60	20	55	20	X10	R/L	▲	804	823	882	973	1010	1041	1101	1211	-
		<b>Appliance unit with compensation door above appliance aperture</b>		78	GO	60	20	55	20	X10A		R/L	▲	804	823	882	973	1010	1041	1101	1211
646 776		<b>Appliance unit</b> 1 door 64.6 cm 2 adjustable shelves 1 panel 1 appliance aperture 58.0 - 59.5 cm 1 door 77.6 cm with wide angle hinges 3 internal drawers		58,0-59,5	GO	60	20	55	20	X7	R/L	▲	794	812	869	964	1001	1028	1090	1199	-
		<b>Appliance unit with compensation door above appliance aperture</b>		78	GO	60	20	55	20	X7A		R/L	▲	794	812	869	964	1001	1028	1090	1199
646 776		<b>Appliance unit</b> 1 door 64.6 cm 2 adjustable shelves 1 panel 1 appliance aperture 58.0 - 59.5 cm 1 door 77.6 cm 1 internal drawer 2 internal pull-outs		58,0-59,5	GO	60	20	55	20	X11	R/L	▲	922	941	1000	1091	1128	1159	1219	1341	-
		<b>Appliance unit with compensation door above appliance aperture</b>		78	GO	60	20	55	20	X11A		R/L	▲	922	941	1000	1091	1128	1159	1219	1341
646 386 386		<b>Appliance unit</b> 1 door 64.6 cm 2 adjustable shelves 1 panel 1 appliance aperture 58.0 - 59.5 cm 2 pull-outs 38.6 cm		58,0-59,5	GO	60	20	55	20	X4	R/L	▲	782	799	856	949	986	1015	1077	1185	-
		<b>Appliance unit with compensation door above appliance aperture</b>		78	GO	60	20	55	20	X4A		R/L	▲	782	799	856	949	986	1015	1077	1185



# Appliance unit 207.8 cm high for microwave / oven

Carcase depth 55.5 cm (standard)

		Order no.			Hinge side:	Carcase depth	Price groups													
		W	H	D			1	2	3	4	5	6	7	8	9					
646 126 646		<b>Appliance unit</b> 1 door 64.6 cm 1 panel 1 appliance aperture 58.0 - 59.5 cm 1 drawer 12.6 cm 1 door 64.6 cm 4 adjustable shelves	58,0-59,5	GO	60	20	55	20	X5	R/L	▲	506	525	580	672	710	743	803	883	-
		<b>Appliance unit with compensation door above appliance aperture</b>	78	GO	60	20	55	20	X5A	R/L	▲	506	525	580	672	710	743	803	883	-
646 126 256 386		<b>Appliance unit</b> 1 door 64.6 cm 1 panel 1 appliance aperture 58.0 - 59.5 cm 1 drawer 12.6 cm 1 pull-out 25.6 cm 1 pull-out 38.6 cm 2 adjustable shelves	58,0-59,5	GO	60	20	55	20	X3	R/L	▲	924	943	997	1082	1117	1147	1212	1333	-
		<b>Appliance unit with compensation door above appliance aperture</b>	78	GO	60	20	55	20	X3A	R/L	▲	924	943	997	1082	1117	1147	1212	1333	-
646 256 256 256		<b>Appliance unit</b> 1 door 64.6 cm 1 panel 1 appliance aperture 58.0 - 59.5 cm 3 pull-outs 25.6 cm 2 adjustable shelves	58,0-59,5	GO	60	20	55	20	X6	R/L	▲	972	990	1052	1126	1165	1194	1257	1383	-
		<b>Appliance unit with compensation door above appliance aperture</b>	78	GO	60	20	55	20	X6A	R/L	▲	972	990	1052	1126	1165	1194	1257	1383	-
386 451		<b>Appliance unit</b> 1 appliance aperture 58.0 - 59.5 cm 1 pull-out 38.6 cm 1 pull-out 45.1 cm 2 adjustable shelves	58,0-59,5	GO	60	20	55	20	X9A	R/L	▲	782	801	859	940	977	1009	1071	1178	-
		<b>Appliance unit with compensation door above appliance aperture</b>	84,5	GO	60	20	55	20	X9A	R/L	▲	782	801	859	940	977	1009	1071	1178	-
585 841		<b>Appliance unit</b> 1 door 58.5 cm 2 adjustable shelves 1 panel 1 appliance aperture 58.0 - 59.5 cm 1 door 84.1 cm 1 internal drawer 2 internal pull-outs	58,0-59,5	GO	60	20	55	20	X13	R/L	▲	922	941	1000	1091	1128	1159	1219	1294	-
		<b>Appliance unit with compensation door above appliance aperture</b>	84,5 NEW	GO	60	20	55	20	X13A	R/L	▲	922	941	1000	1091	1128	1159	1219	1294	-
585 841		<b>Appliance unit</b> 1 door 58.5 cm 1 panel 1 appliance aperture 58.0 - 59.5 cm 1 door 84.1 cm 4 adjustable shelves	58,0-59,5	GO	60	20	55	20	8	R/L	▲	448	467	526	617	654	685	745	820	-
		<b>Appliance unit with compensation door above appliance aperture</b>	84,5 NEW	GO	60	20	55	20	8A	R/L	▲	448	467	526	617	654	685	745	820	-
585 841		<b>Appliance unit</b> 1 door 58.5 cm 2 adjustable shelves 1 panel 1 appliance aperture 58.0 - 59.5 cm 1 door 84.1 cm 2 internal pull-outs	58,0-59,5	GO	60	20	55	20	X12	R/L	▲	804	823	882	973	1010	1041	1101	1176	-
		<b>Appliance unit with compensation door above appliance aperture</b>	84,5 NEW	GO	60	20	55	20	X12A	R/L	▲	804	823	882	973	1010	1041	1101	1176	-
581 126 256 451		<b>Appliance unit</b> 1 door 58.1 cm 1 panel 1 appliance aperture 58.0 - 59.5 cm 1 drawer 12.6 cm 1 pull-out 25.6 cm 1 pull-out 45.1 cm 1 adjustable shelf	58,0-59,5	GO	60	20	55	20	X8	R/L	▲	924	943	997	1082	1117	1147	1212	1333	-
		<b>Appliance unit with compensation door above appliance aperture</b>	84,5	GO	60	20	55	20	X8A	R/L	▲	924	943	997	1082	1117	1147	1212	1333	-



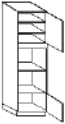
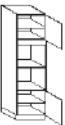
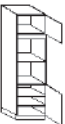
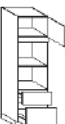


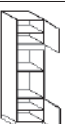

Models not available with compensation door: MIAMI, VIVA



# Appliance unit 207.8 cm high for microwave / oven Double aperture

Carcase depth 55.5 cm (standard)



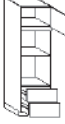


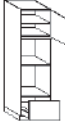


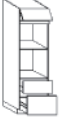
▲ = Types also available with 61 cm carcass depth (order no. ... replace ... 55 ... with 61)

				Order no.			Hinge side:	Carcass depth	Price groups											
				W	H	D			1	2	3	4	5	6	7	8	9			
646 386		<b>Appliance unit</b> 1 door 64.6 cm 1 panel 1 appliance aperture 45.0 cm 1 appliance aperture 45.0 cm 1 door 38.6 cm 2 adjustable shelves	45,0	GO	60	20	55	09	A	R/L	▲	478	494	552	643	682	708	773	850	-
			45,0	GO	60	20	55	09	AA	R/L	▲	478	494	552	643	682	708	773	850	-
516 516		<b>Appliance unit</b> 1 door 51.6 cm 1 panel 1 appliance aperture 45.0 cm 1 appliance aperture 45.0 cm 1 door 51.6 cm 2 adjustable shelves	45,0	GO	60	20	55	09	B	R/L	▲	478	494	552	643	682	708	773	850	-
			45,0	GO	60	20	55	09	BA	R/L	▲	478	494	552	643	682	708	773	850	-
386 646		<b>Appliance unit</b> 1 door 38.6 cm 1 panel 1 appliance aperture 45.0 cm 1 appliance aperture 45.0 cm 1 door 64.6 cm 2 adjustable shelves	45,0	GO	60	20	55	09	C	R/L	▲	478	494	552	643	682	708	773	850	-
			45,0	GO	60	20	55	09	CA	R/L	▲	478	494	552	643	682	708	773	850	-
386 256 386		<b>Appliance unit</b> 1 door 38.6 cm 1 panel 1 appliance aperture 45.0 cm 1 appliance aperture 45.0 cm 1 pull-out 25.6 cm 1 pull-out 38.6 cm	45,0	GO	60	20	55	09	C2	R/L	▲	782	801	859	940	977	1009	1071	1178	-
			45,0	GO	60	20	55	09	C2A	R/L	▲	782	801	859	940	977	1009	1071	1178	-
646 386		<b>Appliance unit</b> 1 door 64.6 cm 1 panel 1 appliance aperture 30.8 - 40.9 cm 1 appliance aperture 58.0 - 59.5 cm 1 door 38.6 cm 2 adjustable shelves	30,8-40,9	GO	60	20	55	27	XA	R/L	▲	448	467	526	617	654	685	745	820	-
			58,0-59,5	GO	60	20	55	27	XAA	R/L	▲	448	467	526	617	654	685	745	820	-
646 386		<b>Appliance unit</b> 1 door 64.6 cm 2 adjustable shelves 1 panel 1 appliance aperture 30.8 - 40.9 cm 1 appliance aperture 58.0 - 59.5 cm 1 pull-out 38.6 cm	30,8-40,9	GO	60	20	55	27	XA2	R/L	▲	599	616	675	766	803	832	896	986	-
			58,0-59,5	GO	60	20	55	27	XA2A	R/L	▲	599	616	675	766	803	832	896	986	-
516 516		<b>Appliance unit</b> 1 door 51.6 cm 1 panel 1 appliance aperture 30.8 - 40.9 cm 1 appliance aperture 58.0 - 59.5 cm 1 door 51.6 cm 2 adjustable shelves	30,8-40,9	GO	60	20	55	27	XB	R/L	▲	448	467	526	617	654	685	745	820	-
			58,0-59,5	GO	60	20	55	27	XBA	R/L	▲	448	467	526	617	654	685	745	820	-
516 126 386		<b>Appliance unit</b> 1 door 51.6 cm 1 adjustable shelf 1 panel 1 appliance aperture 30.8 - 40.9 cm 1 appliance aperture 58.0 - 59.5 cm 1 drawer 12.6 cm 1 pull-out 38.6 cm	30,8-40,9	GO	60	20	55	27	XB3	R/L	▲	744	762	819	911	949	977	1039	1143	-
			58,0-59,5	GO	60	20	55	27	XB3A	R/L	▲	744	762	819	911	949	977	1039	1143	-



# Appliance unit 207.8 cm high for microwave / oven Double aperture

Carcase depth 55.5 cm (standard)

				Order no.		Hinge side: Carcase depth	Price groups								
				W	H		D	1	2	3	4	5	6	7	8
386 646		<b>Appliance unit</b> 1 door 38.6 cm 1 panel 1 appliance aperture 30.8 - 40.9 cm 1 appliance aperture 58.0 - 59.5 cm 1 door 64.6 cm 2 adjustable shelves	30.8-40.9	<b>GO 60 20 55 27 XC</b>	R/L	▲	448	467	526	617	654	685	745	820	-
		<b>Appliance unit with compensation door above appliance aperture</b>	58.0-59.5	<b>GO 60 20 55 27 XCA</b>	R/L	▲	448	467	526	617	654	685	745	820	-
386 256 386		<b>Appliance unit</b> 1 door 38.6 cm 1 panel 1 appliance aperture 30.8 - 40.9 cm 1 appliance aperture 58.0 - 59.5 cm 1 pull-out 25.6 cm 1 pull-out 38.6 cm	30.8-40.9	<b>GO 60 20 55 27 XC2</b>	R/L	▲	782	801	859	940	977	1009	1071	1178	-
		<b>Appliance unit with compensation door above appliance aperture</b>	58.0-59.5	<b>GO 60 20 55 27 XC2A</b>	R/L	▲	782	801	859	940	977	1009	1071	1178	-
386 256 256		<b>Appliance unit</b> 1 door 38.6 cm 1 panel 1 appliance aperture 37.2 - 50 cm 1 appliance aperture 58.0 - 59.5 cm 2 pull-outs 25.6 cm	37.2-50.0	<b>GO 60 20 55 28 XB4</b>	R/L	▲	782	799	856	949	986	1015	1077	1185	-
		<b>Appliance unit with compensation door above appliance aperture</b>	58.0-59.5	<b>GO 60 20 55 28 XB4A</b>	R/L	▲	782	799	856	949	986	1015	1077	1185	-
516 451		<b>Appliance unit</b> 1 door 51.6 cm 1 adjustable shelf 1 panel 1 appliance aperture 41 - 50 cm 1 appliance aperture 58.0 - 59.5 cm 1 pull-out 45.1 cm 1 adjustable shelf	41.0-50.0	<b>GO 60 20 55 28 XA4</b>	R/L	▲	599	616	675	766	803	832	896	986	-
		<b>Appliance unit with compensation door above appliance aperture</b>	58.0-59.5	<b>GO 60 20 55 28 XA4A</b>	R/L	▲	599	616	675	766	803	832	896	986	-
516 386		<b>Appliance unit</b> 1 door 51.6 cm 1 panel 1 appliance aperture 41 - 50 cm 1 appliance aperture 58.0 - 59.5 cm 1 door 38.6 cm 1 adjustable shelf	41.0-50.0	<b>GO 60 20 55 28 XA</b>	R/L	▲	448	467	526	617	654	685	745	820	-
		<b>Appliance unit with compensation door above appliance aperture</b>	58.0-59.5	<b>GO 60 20 55 28 XAA</b>	R/L	▲	448	467	526	617	654	685	745	820	-
516 386		<b>Appliance unit</b> 1 door 51.6 cm 1 adjustable shelf 1 panel 1 appliance aperture 41 - 50 cm 1 appliance aperture 58.0 - 59.5 cm 1 pull-out 38.6 cm	41.0-50.0	<b>GO 60 20 55 28 XA2</b>	R/L	▲	599	616	675	766	803	832	896	986	-
		<b>Appliance unit with compensation door above appliance aperture</b>	58.0-59.5	<b>GO 60 20 55 28 XA2A</b>	R/L	▲	599	616	675	766	803	832	896	986	-
386 516		<b>Appliance unit</b> 1 door 38.6 cm 1 panel 1 appliance aperture 41 - 50 cm 1 appliance aperture 58.0 - 59.5 cm 1 door 51.6 cm 1 adjustable shelf	41.0-50.0	<b>GO 60 20 55 28 XB</b>	R/L	▲	448	467	526	617	654	685	745	820	-
		<b>Appliance unit with compensation door above appliance aperture</b>	58.0-59.5	<b>GO 60 20 55 28 XBA</b>	R/L	▲	448	467	526	617	654	685	745	820	-
386 126 386		<b>Appliance unit</b> 1 door 38.6 cm 1 panel 1 appliance aperture 41 - 50 cm 1 appliance aperture 58.0 - 59.5 cm 1 drawer 12.6 cm 1 pull-out 38.6 cm	41.0-50.0	<b>GO 60 20 55 28 XB3</b>	R/L	▲	744	762	819	911	949	977	1039	1143	-
		<b>Appliance unit with compensation door above appliance aperture</b>	58.0-59.5	<b>GO 60 20 55 28 XB3A</b>	R/L	▲	744	762	819	911	949	977	1039	1143	-
256 256 386		<b>Appliance unit</b> 1 flap door 25.6 cm 1 panel 1 appliance aperture 41 - 50 cm 1 appliance aperture 58.0 - 59.5 cm 1 pull-out 25.6 cm 1 pull-out 38.6 cm	41.0-50.0	<b>GO 60 20 55 28 XC2</b>		▲	782	801	859	940	977	1009	1071	1178	-

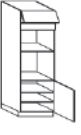
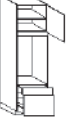
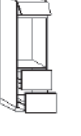
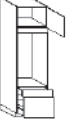
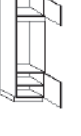


Models not available with compensation door: MIAMI, VIVA

# Appliance unit 207.8 cm high for microwave / oven Double aperture

Carcase depth 55.5 cm (standard)

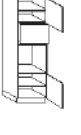

▲ = Types also available with 61 cm carcase depth (order no. ... replace ... 55 ... with 61)

		Order no.				Hinge side:		Carcase depth		Price groups											
		W H D								1	2	3	4	5	6	7	8	9			
256 646		<b>Appliance unit</b> 1 flap door 25.6 cm 1 panel 1 appliance aperture 41 - 50 cm 1 appliance aperture 58.0 - 59.5 cm 1 door 64.6 cm 2 adjustable shelves	41,0-50,0	GO	60	20	55	28	XC	R/L	▲	448	467	526	617	654	685	745	820	-	
			58,0-59,5																		
516 126 386		<b>Appliance unit</b> 1 door 51.6 cm 1 adjustable shelf 1 panel 1 appliance aperture 80 - 95 cm 1 drawer 12.6 cm 1 pull-out 38.6 cm <b>Appliance unit with compensation door above appliance aperture</b>	80,0-95,0	GO	60	20	55	24	X	R/L	▲	744	762	819	911	949	977	1039	1143	-	
				GO	60	20	55	24	XA	R/L	▲	744	762	819	911	949	977	1039	1143	-	
		<b>optional accessories:</b> <b>Appliance support bracket set including fixing materials</b>		GAW-SET								29.80									
256 386 386		<b>Appliance unit</b> 1 flap door 25.6 cm 1 panel 1 appliance aperture 87 - 95 cm 2 pull-outs 38.6 cm	87,0-95,0	GO	60	20	55	21	X1	R/L	▲	780	801	855	949	984	1018	1077	1185	-	
			78																		
		<b>optional accessories:</b> <b>Appliance support bracket set including fixing materials</b>		GAW-SET								29.80									
386 126 386		<b>Appliance unit</b> 1 door 38.6 cm 1 panel 1 appliance aperture 100-116,8 cm 1 drawer 12.6 cm 1 pull-out 38.6 cm <b>Appliance unit with compensation door above appliance aperture</b>	100-116,8	GO	60	20	55	25	X	R/L	▲	745	764	818	909	949	978	1041	1145	-	
				GO	60	20	55	25	XA	R/L	▲	745	764	818	909	949	978	1041	1145	-	
		<b>optional accessories:</b> <b>Appliance support bracket set including fixing materials</b>		GAW-SET								29.80									
386 516		<b>Appliance unit</b> 1 door 38.6 cm 1 panel 1 appliance aperture 100-116,8 cm 1 door 51.6 cm 1 adjustable shelf <b>Appliance unit with compensation door above appliance aperture</b>	100-116,8	GO	60	20	55	32	XB	R/L	▲	448	467	526	617	654	685	745	820	-	
				GO	60	20	55	32	XBA	R/L	▲	448	467	526	617	654	685	745	820	-	
		<b>optional accessories:</b> <b>Appliance support bracket set including fixing materials</b>		GAW-SET								29.80									

# Appliance unit 207.8 cm high for microwave / oven Lifting door / aperture

Carcase depth 55.5 cm (standard)

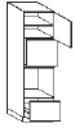
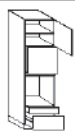



▲ = Types also available with 61 cm carcase depth (order no. ... replace ... 55 ... with 61)

516 386 516		<b>Appliance unit</b> 1 door 51.6 cm 1 lifting door with front 38.6 cm 1 panel 1 appliance aperture 58.0 - 59.5 cm 1 door 51.6 cm 2 adjustable shelves <b>Appliance unit with compensation door above appliance aperture</b>	58,0-59,5	GO	60	20	55	29	X	R/L	▲	581	599	655	744	782	813	873	960	-
				GO	60	20	55	29	XA	R/L	▲	581	599	655	744	782	813	873	960	-
516 386 126 386		<b>Appliance unit</b> 1 door 51.6 cm 1 adjustable shelf 1 lifting door with front 38.6 cm 1 panel 1 appliance aperture 58.0 - 59.5 cm 1 drawer 12.6 cm 1 pull-out 38.6 cm <b>Appliance unit with compensation door above appliance aperture</b>	58,0-59,5	GO	60	20	55	29	X2	R/L	▲	873	895	950	1038	1075	1108	1170	1287	-
				GO	60	20	55	29	X2A	R/L	▲	873	895	950	1038	1075	1108	1170	1287	-



# Appliance unit 207.8 cm high for microwave / oven Lifting door / aperture

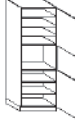
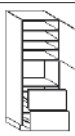
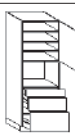
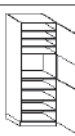
Carcase depth 55.5 cm (standard)

			Order no.			Hinge side:	Carcase depth	Price groups								
			W	H	D			1	2	3	4	5	6	7	8	9
516 516 386		<b>Appliance unit</b> 1 door 51.6 cm 1 lifting door with front 51.6 cm 1 panel 1 appliance aperture 58.0 - 59.5 cm 1 pull-out 38.6 cm 1 adjustable shelf ⚡ <b>Appliance unit with compensation door above appliance aperture</b>	58,0-59,5	GO	60 20 55 36 X5	R/L ▲	730	747	805	895	930	964	1024	1126	-	
			GO	60 20 55 36 X5A	R/L ▲	730	747	805	895	930	964	1024	1126	-		
516 516 126 256		<b>Appliance unit</b> 1 door 51.6 cm 1 adjustable shelf 1 lifting door with front 51.6 cm 1 panel 1 appliance aperture 58.0 - 59.5 cm 1 drawer 12.6 cm 1 pull-out 25.6 cm ⚡ <b>Appliance unit with compensation door above appliance aperture</b>	58,0-59,5	GO	60 20 55 36 X6	R/L ▲	873	895	950	1038	1075	1108	1170	1287	-	
			GO	60 20 55 36 X6A	R/L ▲	873	895	950	1038	1075	1108	1170	1287	-		
386 516 126 386		<b>Appliance unit</b> 1 flap door 38.6 cm 1 lifting door with front 51.6 cm 1 panel 1 appliance aperture 58.0 - 59.5 cm 1 drawer 12.6 cm 1 pull-out 38.6 cm	58,0-59,5	GO	60 20 55 36 X4	▲	873	895	950	1038	1075	1108	1170	1287	-	
386 386 256 386		<b>Appliance unit</b> 1 door 38.6 cm 1 lifting door with front 38.6 cm 1 panel 1 appliance aperture 58.0 - 59.5 cm 1 pull-out 25.6 cm 1 pull-out 38.6 cm ⚡ <b>Appliance unit with compensation door above appliance aperture</b>	58,0-59,5	GO	60 20 55 29 X3	R/L ▲	912	930	987	1075	1113	1144	1206	1327	-	
			GO	60 20 55 29 X3A	R/L ▲	912	930	987	1075	1113	1144	1206	1327	-		
386 516 256 256		<b>Appliance unit</b> 1 flap door 38.6 cm 1 lifting door with front 51.6 cm 1 panel 1 appliance aperture 58.0 - 59.5 cm 2 pull-outs 25.6 cm	58,0-59,5	GO	60 20 55 36 X2	R/L ▲	912	930	987	1075	1113	1144	1206	1327	-	

# Appliance unit 207.8 cm high for microwave / oven 30 inches wide (76.2 cm)

Carcase depth 55.5 cm (standard)

▲ = Types also available with 61 cm carcase depth (order no. ... replace ... 55 ... with 61)

776		<b>Appliance unit</b> 1 compensation door 3 adjustable shelves 1 appliance aperture 36.2 - 50 cm 1 door 77.6 cm 2 adjustable shelves	76,2	GO	76 20 55 10 1A	R/L ▲	569	593	668	784	831	870	946	1041	-	
			36,2-50,0	⚡ <b>Not available for:</b> ALUELEMENTS, FRAME, INTARSIA, MIAMI, STRIP ELEMENTS, VIVA												
		78														
386 386		<b>Appliance unit</b> 1 compensation door 3 adjustable shelves 1 appliance aperture 36.2 - 50 cm 2 pull-outs 38.6 cm	76,2	GO	76 20 55 10 X4A	R/L ▲	1064	1087	1162	1276	1326	1361	1440	1584	-	
			36,2-50,0	⚡ <b>Not available for:</b> ALUELEMENTS, FRAME, INTARSIA, MIAMI, STRIP ELEMENTS, VIVA												
		78														
126 256 386		<b>Appliance unit</b> 1 compensation door 3 adjustable shelves 1 appliance aperture 36.2 - 50 cm 1 drawer 12.6 cm 1 pull-out 25.6 cm 1 pull-out 38.6 cm	76,2	GO	76 20 55 10 2A	R/L ▲	1175	1198	1273	1387	1436	1472	1551	1706	-	
			36,2-50,0	⚡ <b>Not available for:</b> ALUELEMENTS, FRAME, INTARSIA, MIAMI, STRIP ELEMENTS, VIVA												
		78														
906		<b>Appliance unit</b> 1 compensation door 3 adjustable shelves 1 appliance aperture 37.3 - 50 cm 1 door 90.6 cm 3 adjustable shelves	76,2	GO	76 20 55 10 A	R/L ▲	569	593	668	784	831	870	946	1041	-	
			37,3-50,0	⚡ <b>Not available for:</b> ALUELEMENTS, FRAME, INTARSIA, MIAMI, STRIP ELEMENTS, VIVA												



Models not available with compensation door: MIAMI, VIVA

# Appliance unit 207.8 cm high for microwave / oven 30 inches wide (76.2 cm)

Carcase depth 55.5 cm (standard)

▲ = Types also available with 61 cm carcase depth (order no. ... replace ... 55 ... with 61)

Order no.  
W H D

Hinge side:	Carcase depth	Price groups															
		1	2	3	4	5	6	7	8	9							
R/L ▲	76,2	GO	76	20	55	17	XA2A	▲	761	782	857	973	1020	1057	1138	1252	-
	45,0	Not available for: ALUELEMENTS, FRAME, INTARSIA, MIAMI, STRIP ELEMENTS, VIVA															
	71,8																
R/L ▲	76,2	GO	76	20	55	20	X3A	▲	1173	1198	1266	1374	1419	1457	1539	1693	-
	58,0-59,5	Not available for: ALUELEMENTS, FRAME, INTARSIA, MIAMI, STRIP ELEMENTS, VIVA															
	78																
R/L ▲	76,2	GO	76	20	55	20	X4A	▲	993	1015	1087	1205	1252	1289	1368	1505	-
	58,0-59,5	Not available for: ALUELEMENTS, FRAME, INTARSIA, MIAMI, STRIP ELEMENTS, VIVA															
	78																
R/L ▲	76,2	GO	76	20	55	20	XA	▲	569	593	668	784	831	870	946	1041	-
	58,0-59,5	Not available for: ALUELEMENTS, FRAME, INTARSIA, MIAMI, STRIP ELEMENTS, VIVA															
	78																
R/L ▲	76,2	GO	76	20	55	19	XA	▲	569	593	668	784	831	870	946	1041	-
	66,0-71,8	Not available for: ALUELEMENTS, FRAME, INTARSIA, MIAMI, STRIP ELEMENTS, VIVA															
	78																
R/L ▲	76,2	GO	76	20	55	19	2A	▲	1173	1198	1266	1374	1419	1457	1539	1693	-
	66,0-71,8	Not available for: ALUELEMENTS, FRAME, INTARSIA, MIAMI, STRIP ELEMENTS, VIVA															
	78																
R/L ▲	76,2	GO	76	20	55	19	X4A	▲	993	1015	1087	1205	1252	1289	1368	1505	-
	66,0-71,8	Not available for: ALUELEMENTS, FRAME, INTARSIA, MIAMI, STRIP ELEMENTS, VIVA															
	78																

# Appliance unit 207.8 cm high for refrigerator/freezer

Carcase depth 55.5 cm (standard)

▲ = Types also available with 61 cm carcase depth (order no. ... replace ... 55 ... with 61)

R/L ▲	37,3-50,0	GOI	60	20	55	11	X	▲	448	467	526	617	654	685	745	820	-
	72,0-88,0	Note: Structural metal shelf at bottom Important: Observe the appliance manufacturers' permitted front weights for fixed door assembly. See overview of models for front weights.															
R/L ▲		GOI	60	20	55	11	XA	▲	448	467	526	617	654	685	745	820	-

💡 Appliance unit with compensation door above appliance aperture






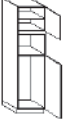
























Models not available with compensation door: MIAMI, VIVA



# Appliance unit 207.8 cm high for refrigerator/freezer

Carcase depth 55.5 cm (standard)

				Order no.		Hinge side:		Price groups								
				W H D		Carcase depth		1	2	3	4	5	6	7	8	9
1063	 <p><b>Appliance unit</b> 1 adjustable shelf 1 appliance aperture 36.0 - 45 cm 1 integrated appliance aperture 102.5 cm 1 door 106.3 cm</p>	36,0-45,0	102,5	<b>GOI 60 20 55 12 X4A</b>	R/L ▲	466	484	542	633	671	701	763	839	-		
								 <i>Important: Observe the appliance manufacturers' permitted front weights for fixed door assembly. See overview of models for front weights.</i>								
516 1166	 <p><b>Appliance unit</b> 1 door 51.6 cm 1 panel 1 appliance aperture 30.8 - 37.2 cm 1 integrated appliance aperture 88.0 - 103 cm 1 door 116.6 cm 1 adjustable shelf</p>	30,8-37,2	88,0-103,0	<b>GOI 60 20 55 02 X</b>	R/L ▲	448	467	526	617	654	685	745	820	-		
								 <i>Important: Observe the appliance manufacturers' permitted front weights for fixed door assembly. See overview of models for front weights.</i>								
								 <b>Appliance unit with compensation door above appliance aperture</b>								
516 1166	 <p><b>Appliance unit with integrated ventilation</b> 1 door 51.6 cm 1 panel 1 appliance aperture 30.8 - 37.2 cm 1 integrated appliance aperture 88.0 - 103 cm 1 door 116.6 cm 1 adjustable shelf</p>	30,8-37,2	88,0-103,0	<b>GOIB 60 20 55 02 X</b>	R/L ▲	466	484	542	633	671	701	763	839	-		
								 <i>Important: Observe the appliance manufacturers' permitted front weights for fixed door assembly. See overview of models for front weights.</i>								
								 <b>Appliance unit with compensation door above appliance aperture</b>								
386 1166	 <p><b>Appliance unit</b> 1 door 38.6 cm 1 panel 1 appliance aperture 37.3 - 50 cm 1 integrated appliance aperture 103 cm 1 door 116.6 cm</p>	37,3-50,0	88,0-103,0	<b>GOI 60 20 55 12 X</b>	R/L ▲	448	467	526	617	654	685	745	820	-		
								 <i>Important: Observe the appliance manufacturers' permitted front weights for fixed door assembly. See overview of models for front weights.</i>								
								 <b>Appliance unit with compensation door above appliance aperture</b>								
386 1166	 <p><b>Appliance unit with integrated ventilation</b> 1 door 38.6 cm 1 panel 1 appliance aperture 37.3 - 50 cm 1 integrated appliance aperture 103 cm 1 door 116.6 cm</p>	37,3-50,0	88,0-103,0	<b>GOIB 60 20 55 12 X</b>	R/L ▲	466	484	542	633	671	701	763	839	-		
								 <i>Important: Observe the appliance manufacturers' permitted front weights for fixed door assembly. See overview of models for front weights.</i>								
								 <b>Appliance unit with compensation door above appliance aperture</b>								
516 1036	 <p><b>Appliance unit</b> 1 door 51.6 cm 1 panel 1 appliance aperture 37.3 - 45 cm 1 integrated appliance aperture 102.3 cm 1 door 103.6 cm 1 adjustable shelf</p>	37,3-45,0	102,3	<b>GOI 60 20 55 12 X1</b>	R/L ▲	523	538	598	688	724	754	815	897	-		
								 <i>Note: Structural metal shelf at bottom</i>  <i>Important: Observe the appliance manufacturers' permitted front weights for fixed door assembly. See overview of models for front weights.</i>								
								 <b>Appliance unit with compensation door above appliance aperture</b>								
256 1296	 <p><b>Appliance unit</b> 1 flap door 25.6 cm 1 panel 1 appliance aperture 37.3 - 50 cm 1 integrated appliance aperture 122.5 cm 1 door 129.6 cm</p>	37,3-50,0	122,5	<b>GOI 60 20 55 13 X</b>	R/L ▲	448	467	526	617	654	685	745	820	-		
								 <i>Important: Observe the appliance manufacturers' permitted front weights for fixed door assembly. See overview of models for front weights.</i>								
386 1036	 <p><b>Appliance unit</b> 1 door 38.6 cm 1 panel 1 appliance aperture 58.0 - 59.5 cm 1 integrated appliance aperture 102.3 cm 1 door 103.6 cm 1 adjustable shelf</p>	58,0-59,5	102,3	<b>GOI 60 20 55 12 X2</b>	R/L ▲	523	538	598	688	724	754	815	897	-		
								 <i>Note: Structural metal shelf at bottom</i>  <i>Important: Observe the appliance manufacturers' permitted front weights for fixed door assembly. See overview of models for front weights.</i>								
								 <b>Appliance unit with compensation door above appliance aperture</b>								
516 906	 <p><b>Appliance unit</b> 1 door 51.6 cm 1 panel 1 appliance aperture 58.0 - 59.5 cm 1 integrated appliance aperture 88 cm 1 door 90.6 cm 1 adjustable shelf</p>	58,0-59,5	88,0	<b>GOI 60 20 55 21 X</b>	R/L ▲	448	467	526	617	654	685	745	820	-		
								 <i>Note: Structural metal shelf at bottom</i>  <i>Important: Observe the appliance manufacturers' permitted front weights for fixed door assembly. See overview of models for front weights.</i>								
								 <b>Appliance unit with compensation door above appliance aperture</b>								








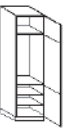





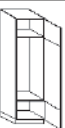















Models not available with compensation door: MIAMI, VIVA

# Appliance unit 207.8 cm high for refrigerator/freezer

Carcase depth 55.5 cm (standard)

▲ = Types also available with 61 cm carcase depth (order no. ... replace ... 55 ... with 61)

		Order no.		Hinge side:	Carcase depth	Price groups								
		W	H			D	1	2	3	4	5	6	7	8
776 386 906		<b>Appliance unit</b> 1 door 77.6 cm 1 lifting door with front 38.6 cm 1 integrated appliance aperture 88 cm 1 door 90.6 cm 2 adjustable shelves	88,0	<b>GI 60 20 55 35 X</b>	R/L ▲	581	599	655	744	782	813	873	960	-
						 Important: Observe the appliance manufacturers' permitted front weights for fixed door assembly. See overview of models for front weights.								
516 906 646		<b>Appliance unit</b> 1 door 51.6 cm 1 integrated appliance aperture 88 cm 1 door 90.6 cm 1 door 64.6 cm 3 adjustable shelves	88,0	<b>GI 60 20 55 30 X</b>	R/L ▲	473	489	565	704	794	844	921	1013	-
						 Important: Observe the appliance manufacturers' permitted front weights for fixed door assembly. See overview of models for front weights.								
516 906 256 386		<b>Appliance unit</b> 1 door 51.6 cm 1 integrated appliance aperture 88 cm 1 door 90.6 cm 1 pull-out 25.6 cm 1 pull-out 38.6 cm 1 adjustable shelf	88,0	<b>GI 60 20 55 30 X2</b>	R/L ▲	806	823	898	1031	1120	1168	1247	1372	-
						 Important: Observe the appliance manufacturers' permitted front weights for fixed door assembly. See overview of models for front weights.								
			<b>Appliance unit with integrated ventilation</b>	<b>GIB 60 20 55 30 X2</b>	R/L ▲	823	838	915	1047	1137	1185	1264	1390	-
386 1036 646		<b>Appliance unit</b> 1 door 38.6 cm 1 integrated appliance aperture 103 cm 1 door 103.6 cm 1 door 64.6 cm 2 adjustable shelves	103,0	<b>GI 60 20 55 40 X</b>	R/L ▲	473	489	565	704	794	844	921	1013	-
						 Important: Observe the appliance manufacturers' permitted front weights for fixed door assembly. See overview of models for front weights.								
			<b>Appliance unit with integrated ventilation</b>	<b>GIB 60 20 55 40 X</b>	R/L ▲	490	506	582	721	811	861	938	1032	-
386 1036 256 386		<b>Appliance unit</b> 1 door 38.6 cm 1 integrated appliance aperture 103 cm 1 door 103.6 cm 1 pull-out 25.6 cm 1 pull-out 38.6 cm	103,0	<b>GI 60 20 55 40 X2</b>	R/L ▲	806	823	898	1031	1120	1168	1247	1372	-
						 Important: Observe the appliance manufacturers' permitted front weights for fixed door assembly. See overview of models for front weights.								
			<b>Appliance unit with integrated ventilation</b>	<b>GIB 60 20 55 40 X2</b>	R/L ▲	823	838	915	1047	1137	1185	1264	1390	-
386 1296 386		<b>Appliance unit</b> 1 door 38.6 cm 1 integrated appliance aperture 122.5 cm 1 door 129.6 cm 1 door 38.6 cm	122,5	<b>GI 60 20 55 50 X</b>	R/L ▲	473	489	565	704	794	844	921	1013	-
						 Important: Observe the appliance manufacturers' permitted front weights for fixed door assembly. See overview of models for front weights.								
			<b>Appliance unit with integrated ventilation</b>	<b>GIB 60 20 55 50 X</b>	R/L ▲	489	505	581	720	810	860	937	1031	-
386 1296 386		<b>Appliance unit</b> 1 door 38.6 cm 1 integrated appliance aperture 122.5 cm 1 door 129.6 cm 1 pull-out 38.6 cm	122,5	<b>GI 60 20 55 50 X1</b>	R/L ▲	622	639	713	851	940	989	1066	1173	-
						 Important: Observe the appliance manufacturers' permitted front weights for fixed door assembly. See overview of models for front weights.								
			<b>Appliance unit with integrated ventilation</b>	<b>GIB 60 20 55 50 X1</b>	R/L ▲	639	655	730	867	956	1005	1083	1191	-
386 386 906 386		<b>Appliance unit</b> 1 door 38.6 cm 1 integrated appliance aperture 122.5 cm 1 door 38.6 cm attached to 1 door 90.6 cm 1 pull-out 38.6 cm	122,5	<b>GI 60 20 55 50 X4</b>	R/L ▲	658	675	749	887	976	1025	1102	1212	-
						 Important: Observe the appliance manufacturers' permitted front weights for fixed door assembly. See overview of models for front weights.								
			<b>Appliance unit with integrated ventilation</b>	<b>GIB 60 20 55 50 X4</b>	R/L ▲	674	691	765	903	992	1041	1118	1230	-
386 386 906 386		<b>Appliance unit</b> 1 door 38.6 cm 1 integrated appliance aperture 122.5 cm 1 door 38.6 cm 1 door 90.6 cm 1 door 38.6 cm	122,5	<b>GI 60 20 55 55 01</b>	R/L ▲	494	515	586	730	818	864	944	1038	-
						 Important: Observe the appliance manufacturers' permitted front weights for fixed door assembly. See overview of models for front weights.								
1296 776		<b>Appliance unit</b> 1 integrated appliance aperture 122.5 cm 1 door 129.6 cm 1 door 77.6 cm 2 adjustable shelves	122,5	<b>GI 60 20 55 50 1X</b>	R/L ▲	494	515	586	730	818	864	944	1038	-
						 Important: Observe the appliance manufacturers' permitted front weights for fixed door assembly. See overview of models for front weights.								
			<b>Appliance unit with integrated ventilation</b>	<b>GIB 60 20 55 50 1X</b>	R/L ▲	494	515	586	730	818	864	944	1038	-





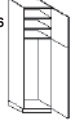



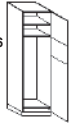

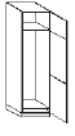

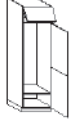

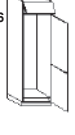

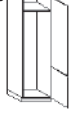

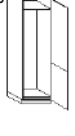

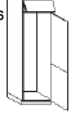



Models not available with compensation door: MIAMI, VIVA



# Appliance unit 207.8 cm high for refrigerator/freezer

Carcase depth 55.5 cm (standard)

			Price groups																							
			Order no.			Hinge side:	Carcase depth	1	2	3	4	5	6	7	8	9										
			W	H	D																					
1296 386 386 	<b>Appliance unit</b> 1 integrated appliance aperture 122.5 cm 1 door 129.6 cm 2 pull-outs 38.6 cm  <b>Appliance unit with integrated ventilation</b>	122,5  78	GI	60	20	55	50	2X	R/L ▲	▲	806	823	898	1031	1120	1168	1247	1372	-							
			 Important: Observe the appliance manufacturers' permitted front weights for fixed door assembly. See overview of models for front weights.										GIB	60	20	55	50	2X	R/L ▲	▲	823	838	915	1047	1137	1185
386 1426 256 	<b>Appliance unit</b> 1 door 38.6 cm 1 integrated aperture 140 cm 1 door 142.6 cm 1 pull-out 25.6 cm	140,0	GI	60	20	55	62	012	R/L ▲	▲	622	639	713	851	940	989	1066	1173	-							
			 Important: Observe the appliance manufacturers' permitted front weights for fixed door assembly. See overview of models for front weights.																							
646 1426 	<b>Appliance unit</b> 1 door 64.6 cm 1 integrated appliance aperture 140 cm 1 door 142.6 cm 2 adjustable shelves	140,0	GI	60	20	55	62	011	R/L ▲	▲	473	489	565	704	794	844	921	1013	-							
			 Important: Observe the appliance manufacturers' permitted front weights for fixed door assembly. See overview of models for front weights.																							
256 1426 386 	<b>Appliance unit</b> 1 flap door 25.6 cm 1 integrated aperture 140 cm 1 door 142.6 cm 1 pull-out 38.6 cm	140,0	GI	60	20	55	62	013	R/L ▲	▲	622	639	713	851	940	989	1066	1173	-							
			 Important: Observe the appliance manufacturers' permitted front weights for fixed door assembly. See overview of models for front weights.																							
516 386 1166 	<b>Appliance unit</b> 1 door 51.6 cm 1 integrated appliance aperture 144.6 cm 1 door 38.6 cm 1 door 116.6 cm 1 adjustable shelf	144,6	GI	60	20	55	68	X1	R/L ▲	▲	473	489	565	704	794	844	921	1013	-							
			 Important: Observe the appliance manufacturers' permitted front weights for fixed door assembly. See overview of models for front weights.																							
386 906 776 	<b>Appliance unit</b> 1 door 38.6 cm 1 integrated appliance aperture 144.6 cm 1 door 90.6 cm 1 door 77.6 cm	144,6  78	GI	60	20	55	68	X2	R/L ▲	▲	473	489	565	704	794	844	921	1013	-							
			 Important: Observe the appliance manufacturers' permitted front weights for fixed door assembly. See overview of models for front weights.																							
321 906 841 	<b>Appliance unit</b> 1 flap door 32.1 cm 1 integrated appliance aperture 144.6 cm 1 door 90.6 cm attached to 1 door 84.1 cm	144,6  84,5	GI	60	20	55	68	X8	R/L ▲	▲	473	489	565	704	794	844	921	1013	-							
			 Important: Observe the appliance manufacturers' permitted front weights for fixed door assembly. See overview of models for front weights.																							
256 1036 776 	<b>Appliance unit</b> 1 flap door 25.6 cm 1 integrated appliance aperture 158 cm 1 door 103.6 cm 1 door 77.6 cm	158,0  78	GI	60	20	55	79	X2	R/L ▲	▲	473	489	565	704	794	844	921	1013	-							
			 Important: Observe the appliance manufacturers' permitted front weights for fixed door assembly. See overview of models for front weights.																							
1426 646 	<b>Appliance unit</b> 1 integrated appliance aperture 177.0 - 178.5 cm 1 door 142.6 cm 1 door 64.6 cm	177,0-178,5	GI	60	20	55	89	X4	R/L ▲	▲	473	489	565	704	794	844	921	1013	-							
			 Important: Observe the appliance manufacturers' permitted front weights for fixed door assembly. See overview of models for front weights.																							
1296 776 	<b>Appliance unit</b> 1 integrated appliance aperture 177.0 - 194.0 cm 1 door 129.6 cm 1 door 77.6 cm  <b>Appliance unit with integrated ventilation</b>	177,0-194,0  78	GI	60	20	55	89	X2	R/L ▲	▲	473	489	565	704	794	844	921	1013	-							
			 Important: Observe the appliance manufacturers' permitted front weights for fixed door assembly. See overview of models for front weights.										GIB	60	20	55	89	X2	R/L ▲	▲	490	506	582	721	811	861
256 1036 776 	<b>Appliance unit</b> 1 flap door 25.6 cm 1 integrated appliance aperture 177.0 - 178.5 cm 1 door 103.6 cm connected to 1 door 77.6 cm	177,0-178,5  78	GI	60	20	55	92	03	R/L ▲	▲	473	489	565	704	794	844	921	1013	-							
			 Important: Observe the appliance manufacturers' permitted front weights for fixed door assembly. See overview of models for front weights.																							


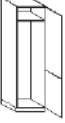

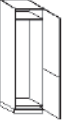

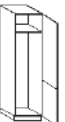





Models not available with compensation door: MIAMI, VIVA

## Appliance unit 207.8 cm high for refrigerator/freezer

Carcase depth 55.5 cm (standard)




▲ = Types also available with 61 cm carcase depth (order no. ... replace ... 55 ... with 61)

		Order no.			Hinge side:	Carcase depth	Price groups								
		W	H	D			1	2	3	4	5	6	7	8	9
1296 776		<b>Appliance unit</b> 1 integrated appliance aperture 178 cm 1 door 129.6 cm 1 door 77.6 cm, supplied separately	178,0	<b>GI 60 20 55 92 41</b>	R/L ▲	473	489	565	704	794	844	921	1013	-	
			78	Important: Observe the appliance manufacturers' permitted front weights for fixed door assembly. See overview of models for front weights.											
1296 776		<b>Appliance unit</b> 1 integrated appliance aperture 178.5 cm 1 door 129.6 cm connected to 1 door 77.6 cm	178,5	<b>GI 60 20 55 92 04</b>	R/L ▲	487	501	578	719	810	856	933	1026	-	
			78	Important: Observe the appliance manufacturers' permitted front weights for fixed door assembly. See overview of models for front weights.											
1231 841		<b>Appliance unit</b> 1 integrated appliance aperture 177.0 - 178.5 cm 1 door 123.1 cm 1 door 84.1 cm	177,0-178,5	<b>GI 60 20 55 89 X8</b>	R/L ▲	473	489	565	704	794	844	921	1013	-	
			84,5	Important: Observe the appliance manufacturers' permitted front weights for fixed door assembly. See overview of models for front weights.											
1231 841		<b>Appliance unit with integrated ventilation</b> 1 integrated appliance aperture 177.0 - 178.5 cm 1 door 123.1 cm connected to 1 door 84.1 cm	177,0-178,5	<b>GIB 60 20 61 89 X8V</b>	R/L	473	489	565	704	794	844	921	1013	-	
			84,5	<b>GIB 60 20 55 89 X8V</b>	R/L ▲	473	489	565	704	794	844	921	1013	-	
2076		<b>Appliance unit</b> 1 door 207.6 cm 1 integrated appliance aperture 177.0 - 178.5 cm	177,0-178,5	<b>GI 60 20 55 92 08</b>	R/L ▲	568	583	657	800	894	936	1015	1117	-	
			NEW	Not available for: ALUELEMENTS, ATLANTA-B, ATLANTA-S, BERGEN, CASTELLO, CHALET-B, CHALET-S, CHICAGO, FRAME, GARDA, LUGANO, LUX-B, MIAMI, MODENA, MUNICH, NEVADA, NOBEL-B, NOBEL-S, ORLANDO-B, ORLANDO-S, OSLO 15, PADUA, SOFIE-B, SOFIE-S, TESSIN 15, TIM 15, TREND, VINO, VIVA, YORK-B, YORK-S  The tightening fitting will be replaced with carrying-door technology on appliance units. Important: Observe the appliance manufacturers' permitted front weights for fixed door assembly. See overview of models for front weights.											
1296 776		<b>Appliance unit with integrated ventilation</b> 1 integrated appliance aperture 177.0 - 194.0 cm 1 door 129.6 cm 1 door 77.6 cm	177,0-194,0	<b>GI 60 20 55 89 X5</b>	R/L ▲	473	489	565	704	794	844	921	1013	-	
			78	<b>GIB 60 20 55 89 X5</b>	R/L ▲	489	505	581	720	810	860	937	1029	-	
386 906 776		<b>Appliance unit</b> 1 door 38.6 cm 1 integrated appliance aperture 88 cm 1 door 90.6 cm 1 integrated appliance aperture 72 cm 1 door 77.6 cm	88,0	<b>GI 60 20 55 32 X</b>	R/L ▲	473	489	565	704	794	844	921	1013	-	
			72,0	Important: Observe the appliance manufacturers' permitted front weights for fixed door assembly. See overview of models for front weights.											
1231 841		<b>Appliance unit with integrated ventilation</b> 1 integrated appliance aperture 103 cm 1 door 123.1 cm 1 integrated appliance aperture 72 cm 1 door 84.1 cm	103,0	<b>GIB 60 20 55 42 X8</b>	R/L ▲	489	505	581	720	810	860	937	1031	-	
			72,0	Important: Observe the appliance manufacturers' permitted front weights for fixed door assembly. See overview of models for front weights.											
256 906 906		<b>Appliance unit</b> 1 flap door 25.6 cm 1 integrated appliance aperture 88 cm 1 door 90.6 cm 1 integrated appliance aperture 88 cm 1 door 90.6 cm	88,0	<b>GI 60 20 55 33 X</b>	R/L ▲	473	489	565	704	794	844	921	1013	-	
			88,0	Important: Observe the appliance manufacturers' permitted front weights for fixed door assembly. See overview of models for front weights.											

## Appliance unit 207.8 cm high for refrigerator/freezer Double aperture

Carcase depth 55.5 cm (standard)

▲ = Types also available with 61 cm carcase depth (order no. ... replace ... 55 ... with 61)

386 906 776		<b>Appliance unit</b> 1 door 38.6 cm 1 integrated appliance aperture 88 cm 1 door 90.6 cm 1 integrated appliance aperture 72 cm 1 door 77.6 cm	88,0	<b>GI 60 20 55 32 X</b>	R/L ▲	473	489	565	704	794	844	921	1013	-
			72,0	Important: Observe the appliance manufacturers' permitted front weights for fixed door assembly. See overview of models for front weights.										
1231 841		<b>Appliance unit with integrated ventilation</b> 1 integrated appliance aperture 103 cm 1 door 123.1 cm 1 integrated appliance aperture 72 cm 1 door 84.1 cm	103,0	<b>GIB 60 20 55 42 X8</b>	R/L ▲	489	505	581	720	810	860	937	1031	-
			72,0	Important: Observe the appliance manufacturers' permitted front weights for fixed door assembly. See overview of models for front weights.										
256 906 906		<b>Appliance unit</b> 1 flap door 25.6 cm 1 integrated appliance aperture 88 cm 1 door 90.6 cm 1 integrated appliance aperture 88 cm 1 door 90.6 cm	88,0	<b>GI 60 20 55 33 X</b>	R/L ▲	473	489	565	704	794	844	921	1013	-
			88,0	Important: Observe the appliance manufacturers' permitted front weights for fixed door assembly. See overview of models for front weights.										



Models not available with compensation door: MIAMI, VIVA

# Appliance unit 207.8 cm high for refrigerator/freezer

Carcase depth 55.5 cm (standard) Widths: 75 cm

▲ = Types also available with 61 cm carcass depth (order no. ... replace ... 55 ... with 61)  
 ■ = Models also available in 34/45.5/61 cm carcass depth (Order no.: ... replace ... 55 ... with 34/45/61)

Order no.  
W H D

Hinge side: Carcass depth	Price groups								
	1	2	3	4	5	6	7	8	9
R/L ■	515	530	609	920	991	1038	1131	1244	-
R/L ■	697	713	792	1102	1173	1221	1315	1447	-
R/L ▲	591	611	706	880	993	1055	1151	1266	-

1296  
776



**Crockery cupboard**  
 1 door 129.6 cm  
 1 door 77.6 cm  
 1 fixed shelf  
 6 adjustable shelves

75

**GG 75 20 55 01**

Not available for:  
 ALUELEMENTS, FRAME, MIAMI, STRIP ELEMENTS, VIVA

The adjustable shelves will be delivered as a separate package.

2076



**Crockery cupboard**  
 1 door 207.6 cm  
 1 fixed shelf  
 6 adjustable shelves

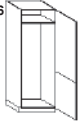
75

**GG 75 20 55 70**

Not available for:  
 ALUELEMENTS, ATLANTA-B, ATLANTA-S, BERGEN, CASTELLO, CHALET-B, CHALET-S, CHICAGO, FRAME, GARDA, LUGANO, LUX-B, MIAMI, MODENA, MUNICH, NEVADA, NOBEL-B, NOBEL-S, ORLANDO-B, ORLANDO-S, OSLO 15, PADUA, SOFIE-B, SOFIE-S, TESSIN 15, TIM 15, TREND, VINO, VIVA, YORK-B, YORK-S

Each front has a tightening fitting  
 Ranges without fitting: SMARTGLAS, NOBEL, SOFIE, YORK, LUGANO, TALEA, RIVA, GARDA, ATLANTA, ORLANDO, CHICAGO without tightening fitting The adjustable shelves will be delivered as a separate package.

1296  
776



**Appliance unit**  
 1 integrated appliance aperture  
 177.0 - 194.0 cm  
 1 door 129.6 cm  
 1 door 77.6 cm

177,0-194,0

75

**GI 75 20 55 89 X5**


Not available for:  
 ALUELEMENTS, FRAME, MIAMI, STRIP ELEMENTS, VIVA

Important: Observe the appliance manufacturers' permitted front weights for fixed door assembly. See overview of models for front weights.

## Fronts for Side by Side refrigerators/freezers 207.8 cm high

Carcass depth 55.5 cm (standard)

2076



**Front for Side by Side integrated freezer**  
 Suitable for carcass height 207.8 cm  
 Dimensions:  
 Height: 207.6 cm  
 Width: 45.1 cm  
 without handle drill holes


**GT SBS 45 20**

152 273 446 715 742 764 1035 1139 -

Width 45 Available for: ALU TEC RP, ARTE-B, ARTE-S, BAVARIA, CASA-B, EDITION, FENIX INOX, FLORENZ, GENT, HPL PRO, MALMÖ, MONTANA, MPX, NEW OPAL-M, OPAL-H, PALAZZO, PALERMO-B, PALERMO-S, PRIMEWOOD TOP, PUR, RESOPAL, RESOPAL PRO, RESOPAL PRO EDGE, RIVA, ROMA-B, ROMA-S, RUSTY OAK, SHERWOOD, SIGNUM-B, SMART, SMART MIRROR, SMART-M, TALEA, TIM, TOP, VILLAGE 15-B, VILLAGE 15-S

Note: When planning, the minimum base height is 10 cm  
 Important: The front is designed for installation between two tall units.  
 Grip ledges not possible

2076



**Front for Side by Side integrated wine chiller with glass door**  
 Framed front, 1 piece  
 Suitable for carcass height 207.8 cm  
 Dimensions:  
 Height: 207.6 cm  
 Width: 45.1 cm  
 without handle drill holes  
 please order the handles separately  
 Suitable for Gaggenau and Liebherr


**GT SBS WK 45 20**

- - 596 865 922 944 1215 1326 -

Width 45 Available for: ARTE-B, ARTE-S, ATLANTA-B, ATLANTA-S, CASA-B, NEW OPAL-M, OPAL-H, PALAZZO, PALERMO-B, PALERMO-S, ROMA-B, ROMA-S, SIGNUM-B, VILLAGE 15-B, VILLAGE 15-S

Note: When planning, the minimum base height is 10 cm  
 Important: The front is designed for installation between two tall units.  
 Grip ledges not possible

2076



**Front for Side by Side integrated wine chiller with glass door**  
 Framed front, 1 piece  
 Suitable for carcass height 207.8 cm  
 Dimensions:  
 Height: 207.6 cm  
 Width: 60.3 cm  
 without handle drill holes  
 please order the handles separately  
 Suitable for Miele, Gaggenau and Liebherr


**GT SBS WK 60 20**

- - 746 1106 1173 1201 1563 1719 -

Width 60 Available for: ARTE-B, ARTE-S, ATLANTA-B, ATLANTA-S, CASA-B, NEW OPAL-M, OPAL-H, PALAZZO, PALERMO-B, PALERMO-S, ROMA-B, ROMA-S, SIGNUM-B, VILLAGE 15-B, VILLAGE 15-S

Note: When planning, the minimum base height is 10 cm  
 Important: The front is designed for installation between two tall units.  
 Grip ledges not possible

2076



**Front for Side by Side integrated fridge and freezer**  
 Suitable for carcass height 207.8 cm  
 Dimensions:  
 Height: 207.6 cm  
 Width: 60.3 cm  
 without handle drill holes


**GT SBS 60 20**

203 366 596 957 993 1022 1383 1521 -

Width 60 Available for: ALU TEC RP, ARTE-B, ARTE-S, BAVARIA, CASA-B, EDITION, FENIX INOX, FLORENZ, GENT, HPL PRO, MALMÖ, MONTANA, MPX, NEW OPAL-M, OPAL-H, PALAZZO, PALERMO-B, PALERMO-S, PRIMEWOOD TOP, PUR, RESOPAL, RESOPAL PRO, RESOPAL PRO EDGE, RIVA, ROMA-B, ROMA-S, RUSTY OAK, SHERWOOD, SIGNUM-B, SMART, SMART MIRROR, SMART-M, TALEA, TIM, TOP, VILLAGE 15-B, VILLAGE 15-S

Note: When planning, the minimum base height is 10 cm  
 Important: The front is designed for installation between two tall units.  
 Grip ledges not possible

2076



**Front for Side by Side integrated fridge and freezer**  
 Suitable for carcass height 207.8 cm  
 Dimensions:  
 Height: 207.6 cm  
 Width: 75.6 cm  
 without handle drill holes

**GT SBS 75 20**

254 458 747 1199 1245 1281 1734 1907 -

Width 75 Available for: ALU TEC RP, ARTE-B, ARTE-S, BAVARIA, CASA-B, EDITION, FENIX INOX, FLORENZ, GENT, HPL PRO, MALMÖ, MONTANA, MPX, NEW OPAL-M, OPAL-H, PALAZZO, PALERMO-B, PALERMO-S, PRIMEWOOD TOP, PUR, RESOPAL, RESOPAL PRO, RESOPAL PRO EDGE, RIVA, ROMA-B, ROMA-S, RUSTY OAK, SHERWOOD, SIGNUM-B, SMART, SMART MIRROR, SMART-M, TALEA, TIM, TOP, VILLAGE 15-B, VILLAGE 15-S







Note: When planning, the minimum base height is 10 cm  
 Important: The front is designed for installation between two tall units.  
 Grip ledges not possible








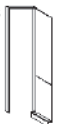





Models not available with compensation door: MIAMI, VIVA

# Fronts for Side by Side refrigerators/freezers 207.8 cm high

Carcase depth 55.5 cm (standard)

Order no.	W H D	Hinge side:	Carcase depth	Price groups									
				1	2	3	4	5	6	7	8	9	
2076				<b>GT SBS 91 20</b>	305	550	897	1440	1495	1538	2083	2291	-
 <p><b>Front for Side by Side integrated fridge and freezer</b> Suitable for carcase height 207.8 cm Dimensions: Height: 207.6 cm Width: 90.8 cm without handle drill holes</p>				<p><b>Width 90 Available for:</b> ALU TEC RP, ARTE-B, ARTE-S, BAVARIA, CASA-B, EDITION, FENIX INOX, FLORENZ, GENT, HPL PRO, MALMÖ, MONTANA, MPX, NEW OPAL-M, OPAL-H, PALAZZO, PALERMO-B, PALERMO-S, PRIMEWOOD TOP, PUR, RESOPAL, RESOPAL PRO, RESOPAL PRO EDGE, RIVA, ROMA-B, ROMA-S, RUSTY OAK, SHERWOOD, SIGNUM-B, SMART, SMART MIR-ROR, SMART-M, TALEA, TIM, TOP, VILLAGE 15-B, VILLAGE 15-S</p> <p> <b>Note:</b> When planning, the minimum base height is 10 cm <b>Important:</b> The front is designed for installation between two tall units. <b>Grip ledges not possible</b></p>									
2076				<b>GT2 SBS 91 20</b>	305	550	896	1438	1493	1536	2080	2288	-
 <p><b>Front for Side by Side integrated fridge and freezer</b> Suitable for carcase height 207.8 cm Dimensions: Front 1: height 72.4 cm, width 90.8 cm Front 2: height 134.9 cm, width 90.8 cm without handle drill holes</p>				<p><b>Width 90 Available for:</b> ALU TEC RP, ARTE-B, ARTE-S, BAVARIA, CASA-B, EDITION, FENIX INOX, FLORENZ, GENT, HPL PRO, MALMÖ, MONTANA, MPX, NEW OPAL-M, OPAL-H, PALAZZO, PALERMO-B, PALERMO-S, PRIMEWOOD TOP, PUR, RESOPAL, RESOPAL PRO, RESOPAL PRO EDGE, RIVA, ROMA-B, ROMA-S, RUSTY OAK, SHERWOOD, SIGNUM-B, SMART, SMART MIR-ROR, SMART-M, TALEA, TIM, TOP, VILLAGE 15-B, VILLAGE 15-S</p> <p> <b>Note:</b> When planning, the minimum base height is 10 cm <b>Important:</b> The front is designed for installation between two tall units. <b>Grip ledges not possible</b></p>									
2076				<b>GT3 SBS 91 20</b>	305	549	895	1436	1491	1534	2077	2285	-
 <p><b>Front for Side by Side integrated fridge and freezer</b> Suitable for carcase height 207.8 cm Dimensions: Front 1: height 72.4 cm, width 90.8 cm Front 2: height 134.9 cm, width 45.2 cm Front 3: height 134.9 cm, width 45.2 cm without handle drill holes</p>				<p><b>Width 90 Available for:</b> ALU TEC RP, ARTE-B, ARTE-S, BAVARIA, CASA-B, EDITION, FENIX INOX, FLORENZ, GENT, HPL PRO, MALMÖ, MONTANA, MPX, NEW OPAL-M, OPAL-H, PALAZZO, PALERMO-B, PALERMO-S, PRIMEWOOD TOP, PUR, RESOPAL, RESOPAL PRO, RESOPAL PRO EDGE, RIVA, ROMA-B, ROMA-S, RUSTY OAK, SHERWOOD, SIGNUM-B, SMART, SMART MIR-ROR, SMART-M, TALEA, TIM, TOP, VILLAGE 15-B, VILLAGE 15-S</p> <p> <b>Note:</b> When planning, the minimum base height is 10 cm <b>Important:</b> The front is designed for installation between two tall units. <b>Grip ledges not possible</b></p>									



## spacefitter frame 207.8 cm high

1426 646		<p><b>Tall unit spacefitter frame</b> 1 door 142.6 cm connected to 1 door 64.6 cm Carcase depth 10 cm For recess cladding</p>	<p><b>GPR 30 20 10 02</b> R/L 244 253 290 373 389 410 453 498 -</p> <p><b>GPR 45 20 10 02</b> R/L 244 253 290 373 389 410 453 498 -</p> <p><b>GPR 50 20 10 02</b> R/L 244 253 290 406 418 441 485 534 -</p> <p><b>GPR 60 20 10 02</b> R/L 268 282 324 476 498 524 573 630 -</p>
1296 776		<p><b>Tall unit spacefitter frame</b> 1 door 129.6 cm connected to 1 door 77.6 cm Carcase depth 10 cm For recess cladding</p>	<p><b>GPR 30 20 10 01</b> R/L 244 253 290 373 389 410 453 498 -</p> <p><b>GPR 45 20 10 01</b> R/L 244 253 290 373 389 410 453 498 -</p> <p><b>GPR 50 20 10 01</b> R/L 244 253 290 406 418 441 485 534 -</p> <p><b>GPR 60 20 10 01</b> R/L 268 282 324 476 498 524 573 630 -</p>
1426 646		<p><b>Tall unit spacefitter frame with swivelling plinth</b> 1 door 142.6 cm connected to 1 door 64.6 cm Carcase depth 10 cm Without bottom shelf With swivelling plinth</p>	<p><b>GPRS 60 20 10 02</b> R/L 322 337 377 530 553 578 628 691 -</p> <p><b>GPRS 70 20 10 02</b> R/L 492 524 588 779 806 833 920 1012 -</p> <p><b>GPRS 80 20 10 02</b> R/L 526 583 688 936 970 1002 1150 1265 -</p> <p> <b>Width 60</b> <b>Width 70, 80 Not available for:</b> ALUELEMENTS, CASTELLO, FRAME, MIAMI, STRIP ELEMENTS, VIVA</p> <p> <b>Planning advice:</b> only for planning between tall units</p>
1296 776		<p><b>Tall unit spacefitter frame with swivelling plinth</b> 1 door 129.6 cm connected to 1 door 77.6 cm Carcase depth 10 cm Without bottom shelf With swivelling plinth</p>	<p><b>GPRS 60 20 10 01</b> R/L 322 337 377 530 553 578 628 691 -</p> <p><b>GPRS 70 20 10 01</b> R/L 492 524 588 779 806 833 920 1012 -</p> <p><b>GPRS 80 20 10 01</b> R/L 526 583 688 936 970 1002 1150 1265 -</p> <p> <b>Width 60</b> <b>Width 70, 80 Not available for:</b> ALUELEMENTS, CASTELLO, FRAME, MIAMI, STRIP ELEMENTS, VIVA</p> <p> <b>Planning advice:</b> only for planning between tall units</p>
1231 841		<p><b>Tall unit spacefitter frame with swivelling plinth</b> 1 door 123.1 cm connected to 1 door 84.1 cm Carcase depth 10 cm Without bottom shelf With swivelling plinth</p>	<p><b>GPRS 60 20 10 05</b> R/L 322 337 377 530 553 578 628 691 -</p> <p><b>GPRS 70 20 10 05</b> R/L 492 524 588 779 806 833 920 1012 -</p> <p><b>GPRS 80 20 10 05</b> R/L 526 583 688 936 970 1002 1150 1265 -</p> <p> <b>Not available for:</b> ALUELEMENTS, CASTELLO, FRAME, MIAMI, STRIP ELEMENTS, VIVA</p> <p> <b>Planning advice:</b> only for planning between tall units</p>

## Passage door elements 207.8 cm high

Carcase depth 55.5 cm (standard)

▲ = Types also available with 61 cm carcase depth (order no. ... replace ... 55 ... with 61)

1426 646		<p><b>Passage door element</b> 1 door 142.6 cm connected to 1 door 64.6 cm Without bottom shelf With swivelling plinth</p>	<p><b>GDT 60 20 55 02</b> R/L ▲ 412 424 487 736 793 830 905 996 -</p> <p><b>GDT 70 20 55 02</b> R/L ▲ 582 611 697 985 1045 1085 1198 1318 -</p> <p><b>GDT 80 20 55 02</b> R/L ▲ 616 671 796 1142 1209 1254 1428 1571 -</p> <p><b>Width 60</b> <b>Width 70, 80 Not available for:</b> ALUELEMENTS, CASTELLO, FRAME, MIAMI, STRIP ELEMENTS, VIVA</p> <p> <b>Planning advice:</b> only for planning between tall units <b>Width 80 cm = grip strip N775 not available</b></p>
-------------	--	--	---




**Passage door elements 207.8 cm high**  
**Carcase depth 55.5 cm (standard)**

Hinge side:	Carcase depth	Price groups								
		1	2	3	4	5	6	7	8	9

▲ = Types also available with 61 cm carcase depth (order no. ... replace ... 55 ... with 61)

Order no.  
W H D

1296  
776




**Passage door element**  
 1 door 129.6 cm connected to 1 door 77.6 cm  
 Without bottom shelf  
 With swivelling plinth

78

GDT	60	20	55	01	R/L ▲	412	424	487	736	793	830	905	996	-
GDT	70	20	55	01	R/L ▲	582	611	697	985	1045	1085	1198	1318	-
GDT	80	20	55	01	R/L ▲	616	671	796	1142	1209	1254	1428	1571	-

Width 60  
 Width 70, 80 Not available for: ALUELEMENTS, CASTELLO, FRAME, MIAMI, STRIP ELEMENTS, VIVA

 The article comprises several packages and is supplied dismantled.  
**Planning advice:** only for planning between tall units  
 Width 80 cm = grip strip N775 not available


1231  
841




**Passage door element**  
 1 door 123.1 cm connected to 1 door 84.1 cm  
 Without bottom shelf  
 With swivelling plinth

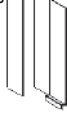
84,5

GDT	60	20	55	05	R/L ▲	412	424	487	736	793	830	905	996	-
GDT	70	20	55	05	R/L ▲	582	611	697	985	1045	1085	1198	1318	-
GDT	80	20	55	05	R/L ▲	616	671	796	1142	1209	1254	1428	1571	-

 Not available for:  
 ALUELEMENTS, CASTELLO, FRAME, MIAMI, STRIP ELEMENTS, VIVA

 The article comprises several packages and is supplied dismantled.  
**Planning advice:** only for planning between tall units  
 Width 80 cm = grip strip N775 not available

2076





**Passage door element**  
 1 door 207.6 cm  
 Without bottom shelf  
 With swivelling plinth

**Planning advice:**  
 only for planning  
 between  
 tall units.


78

GDT	60	20	55	70	R/L ▲	492	505	566	816	873	909	986	1085	-
GDT	70	20	55	70	R/L ▲	699	727	814	1102	1162	1202	1314	1445	-
GDT	80	20	55	70	R/L ▲	732	788	913	1259	1326	1371	1544	1698	-

 Not available for:  
 ALUELEMENTS, ATLANTA-B, ATLANTA-S, BERGEN, CASTELLO, CHALET-B, CHALET-S, CHICAGO, FRAME, GARDA, LUGANO, LUX-B, MIAMI, MODENA, MUNICH, NEVADA, NOBEL-B, NOBEL-S, ORLANDO-B, ORLANDO-S, OSLO 15, PADUA, SOFIE-B, SOFIE-S, TESSIN 15, TIM 15, TREND, VINO, VIVA, YORK-B, YORK-S

 Each front has a tightening fitting  
 Ranges without fitting: SMARTGLAS, NOBEL, SOFIE, YORK, LUGANO, TALEA, RIVA, GARDA, ATLANTA, ORLANDO, CHICAGO without tightening fitting  
 The article comprises several packages and is supplied dismantled.  
**Planning advice:** only for planning between tall units


1426  
646



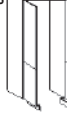
**Passage door element**  
 2 doors 142.6 cm  
 connected to 2 doors 64.6 cm  
 Without bottom shelf  
 With swivelling plinth

78

GDT	90	20	55	02	▲	851	883	983	1131	1206	1257	1365	1502	-
GDT	100	20	55	02	▲	936	972	1082	1244	1327	1383	1502	1652	-
GDT	120	20	55	02	▲	1021	1060	1180	1358	1448	1508	1639	1803	-

 The article comprises several packages and is supplied dismantled.  
**Planning advice:** only for planning between tall units


1296  
776




**Passage door element**  
 2 doors 129.6 cm connected with 2 doors 77.6 cm  
 Without bottom shelf  
 With swivelling plinth

78

GDT	90	20	55	01	▲	851	883	983	1131	1206	1257	1365	1502	-
GDT	100	20	55	01	▲	936	972	1082	1244	1327	1383	1502	1652	-
GDT	120	20	55	01	▲	1021	1060	1180	1358	1448	1508	1639	1803	-

 The article comprises several packages and is supplied dismantled.  
**Planning advice:** only for planning between tall units


2076




**Passage door element**  
 2 doors 207.6 cm  
 Without bottom shelf  
 With swivelling plinth


78

GDT	90	20	55	70	▲	1012	1043	1144	1291	1367	1417	1526	1679	-
GDT	100	20	55	70	▲	1113	1148	1258	1419	1504	1559	1679	1847	-
GDT	120	20	55	70	▲	1214	1252	1373	1549	1641	1700	1832	2015	-

 Not available for:  
 ALUELEMENTS, ATLANTA-B, ATLANTA-S, BERGEN, CASTELLO, CHALET-B, CHALET-S, CHICAGO, FRAME, GARDA, LUGANO, LUX-B, MIAMI, MODENA, MUNICH, NEVADA, NOBEL-B, NOBEL-S, ORLANDO-B, ORLANDO-S, OSLO 15, PADUA, SOFIE-B, SOFIE-S, TESSIN 15, TIM 15, TREND, VINO, VIVA, YORK-B, YORK-S

 Each front has a tightening fitting  
 Ranges without fitting: SMARTGLAS, NOBEL, SOFIE, YORK, LUGANO, TALEA, RIVA, GARDA, ATLANTA, ORLANDO, CHICAGO without tightening fitting  
 The article comprises several packages and is supplied dismantled.  
**Planning advice:** only for planning between tall units


2076




**Passage door element**  
 1 door 207.6 cm  
 Without bottom shelf  
 with front extension downwards  
 (depending on the plinth height - max. 20 cm)

78

GDTV	60	20	55	70	R/L ▲	628	640	707	984	1073	1123	1212	1333	-
GDTV	70	20	55	70	R/L ▲	887	917	991	1286	1364	1413	1524	1676	-
GDTV	80	20	55	70	R/L ▲	938	1005	1136	1514	1613	1670	1867	2054	-

 Width 60, 70, 80 Not available for: ALUELEMENTS, ATLANTA-B, ATLANTA-S, BERGEN, CASTELLO, CHALET-B, CHALET-S, CHICAGO, FRAME, GARDA, LUGANO, LUX-B, MIAMI, MODENA, MUNICH, NEVADA, NOBEL-B, NOBEL-S, ORLANDO-B, ORLANDO-S, OSLO 15, PADUA, SOFIE-B, SOFIE-S, TESSIN 15, TIM 15, TREND, VINO, VIVA, YORK-B, YORK-S

 The article comprises several packages and is supplied dismantled.  
 Each front has a tightening fitting  
 Ranges without fitting: SMARTGLAS, NOBEL, SOFIE, YORK, LUGANO, TALEA, RIVA, GARDA, ATLANTA, ORLANDO, CHICAGO without tightening fitting  
**Planning advice:** only for planning between tall units

**Passage door elements 207.8 cm high**  
Carcase depth 55.5 cm (standard)

Hinge side: Carcase depth	Price groups								
	1	2	3	4	5	6	7	8	9

Order no.  
W H D

▲ = Types also available with 61 cm carcase depth (order no. ... replace ... 55 ... with 61)

**Through-door with pivot door fitting Version:**

The through-door with pivot door fitting is planned as an intermediate construction variant at the top with a fixed panel (front and rear). The door is a doubled front with integrated fittings.

**Planning dimensions:**

Planning widths: 80 cm (variable from 70.1 cm to 80 cm)

Planning depth: 55.5 cm = carcase depth

Planning heights: 207.8 cm and 220.8 cm + plinth height

Note: The front heights match units with a height of 207.8 cm or 220.8 cm with a front extension with a clearance of 1.5 cm from the floor.

The maximum plinth height is 10 cm.

**Important:**

The door turns inward beyond the cabinet depth of 55.5 cm!

The pivot range must be taken into account in accordance with the floor plan drawing (see below).

If the door cannot swing inwards freely, the row of units must be pulled forward and increased side depths must be taken into account for the adjacent units!

**Planning notes:**

Only through-doors are available.

The passage door with pivot door fitting can only be planned between tall cabinets

or between tall cabinets and a wall.

Directly connected fillers are not possible!

The set does not contain panels.

Further planning is only possible with a cabinet height of 207.8 cm or 220.8 cm. Offset!

The maximum plinth height is 10 cm. Here, any front extensions are to be taken into consideration.

**Further information:**

The lower fitting must not be affixed to the base shelf. The lower door guide is connected to the unit side of the tall unit planned next to it or to a wall using a mounting bracket.

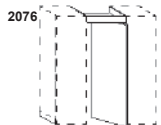
**Very important note:**

Due to the inward turning function, the vertical joint dimensions of the swing door deviate from the standard dimensions.

For technical reasons, a larger gap dimension is necessary here. Due to the hardware technology used and the resulting kinematics, an exactly flush alignment of the element cannot be guaranteed in every case.

**Material design**

Front: front colour / model  
front doubling inside: carcase colour  
intermediate installation: carcase colour  
panels: front colour / model The maximum plinth height is 10 cm



**Through-door with pivot fitting for tall unit rows**

consisting of:  
1 continuous door opening inwards, extended by plinth height and with a 1.5 cm distance to the floor incl. front doubling on the inside  
Door width 70.1 - 80 cm  
- please specify exact width  
Depending on model the door will be equipped with 1 tightening fitting  
1 fitting set incl. mounting bracket  
1 intermediate installation element with panel 12.6 cm above the through-door

**Planning advice:**  
only for planning between tall units.



**GDTV80 20 55**

R/L	▲	1659	1884	1953	2812	2933	2997	3514	3865	-
-----	---	------	------	------	------	------	------	------	------	---

**Not available for:**

ALU TEC RP, ALUELEMENTS, ATLANTA-B, ATLANTA-S, BERGEN, CASTELLO, CHALET-B, CHALET-S, CHICAGO, FRAME, GARDA, INTARSIA, LUGANO, LUX-B, MIAMI, MODENA, MUNICH, NEVADA, NOBEL-B, NOBEL-S, ORLANDO-B, ORLANDO-S, OSLO 15, PADUA, SOFIE-B, SOFIE-S, TESSIN 15, TIM 15, TREND, VINO, VIVA, YORK-B, YORK-S

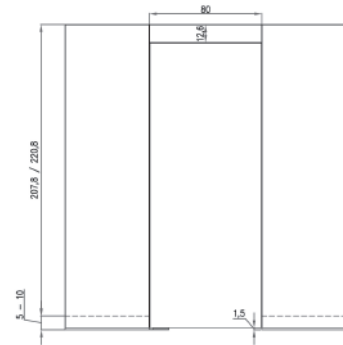
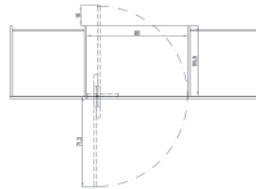


The article comprises several packages and is supplied dismantled.

Each front has a tightening fitting

Ranges without fitting: SMARTGLAS, NOBEL, SOFIE, YORK, LUGANO, TALEA, RIVA, GARDA, ATLANTA, ORLANDO, CHICAGO without tightening fitting

**Planning advice:** only for planning between tall units



**Front filler 207.8 cm high**  
Carcase depth 55.5 cm (standard)



**Tall unit front filler**  
207.8 cm high

3.5 - 10 cm  
10.1 - 20 cm



**Note:**

Models with horizontally running graining can only be supplied with 2-part front trim panel:  
Upper dimension: 129.6 cm  
Lower dimension: 77.6 cm

<b>GP 10 20</b>			100	100	110	161	161	161	170	187	-
-----------------	--	--	-----	-----	-----	-----	-----	-----	-----	-----	---

<b>GP 20 20</b>			110	110	120	182	182	182	200	220	-
-----------------	--	--	-----	-----	-----	-----	-----	-----	-----	-----	---



**Tall unit corner filler 90°**  
207.8 cm high

As corner connection between 2 tall units  
Without shelf, 9.5 x 9.5 cm

<b>GPW 90 20</b>			124	124	138	200	200	200	214	235	-
------------------	--	--	-----	-----	-----	-----	-----	-----	-----	-----	---




**Note:**

Models with horizontally running graining can only be supplied with 2-part front trim panel:  
Upper dimension: 129.6 cm  
Lower dimension: 77.6 cm

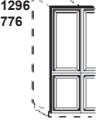
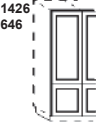
## Front filler 207.8 cm high

Carcase depth 55.5 cm (standard)



	Order no. W H D	Hinge side: Carcase depth	Price groups								
			1	2	3	4	5	6	7	8	9
 <p><b>Tall unit corner filler 135°</b> 207.8 cm high For cladding blind corners Planning dimensions 25.9 x 25.9 cm</p>	<p><b>GPW 135 20</b></p> <p><b>Not available for:</b> ALU TEC RP</p> <p><b>Note:</b> Models with horizontally running graining can only be supplied with 2-part front trim panel: Upper dimension: 129.6 cm Lower dimension: 77.6 cm</p>		124	124	138	200	200	200	214	235	-

## Back cladding 207.8 cm high with screw-fitted fronts

Carcase depth 55.5 cm (standard)

	Order no. W H D	Hinge side: Carcase depth	Price groups								
			1	2	3	4	5	6	7	8	9
 <p><b>Back cladding</b> For tall units, 207.8 cm high Carcase material with screw-fitted fronts, 129.6 cm and 77.6 cm Only available in grid sizes</p>	<p>per 10 cm Width</p> <p><b>GVF 20 01</b></p> <p><b>Important!</b> Plinth panel is supplied loose.</p>		65	68	71	89	91	95	101	111	-
 <p><b>Back cladding</b> For tall units, 207.8 cm high Carcase material with screw-fitted fronts 1 front 142.6 cm attached to 1 front 64.6 cm Only available in grid sizes</p>	<p>per 10 cm Width</p> <p><b>GVF 20 02</b></p> <p><b>Important!</b> Plinth panel is supplied loose.</p>		65	68	71	89	91	95	101	111	-



## Back cladding 207.8 cm high

	Order no. W H D	Hinge side: Carcase depth	Decor groups								
			M10	M20	M30	M40	M50	M60	M70	M80	M90
 <p><b>Back cladding</b> For tall units, 207.8 cm high 16 mm thick</p>	<p>per 10 cm Width</p> <p><b>GVK 20</b></p>		27,50	48	75	100	100	100	100	100	-
 <p><b>Tall unit background filler</b> Width: 20 cm For fitting flush with carcass 207.8 cm high</p>	<p>Unit price</p> <p><b>GPSL 00 20</b></p>		45	53	117	156	156	156	156	156	-

M 10	M 20	M 30	M 40	M 50
K M10 laminate	D M20 Laminate decor	I M30 RESOPAL PRO super matt IH M30 HPL PRO PW M30 PRIMEWOOD/Basic Veneer	A M40 DIRECTLACK matt L M40 DIRECTLACK high-gloss	B M50 Velvet lacquer S M50 microstructure lacquer
M 60	M 70	M 80	M 90	
QH M60 SMARTGLAS high-gloss QM M60 SMARTGLAS satin-finish	F M70 veneer / oak / walnut Z M70 Veneer / Bavaria	C1 M80 FENIX stainless-steel look H M80 high gloss-Lacquer MP M80 laqué mat Premium		






**Visible sides / increased side depth 207.8 cm high**

		Decor groups										
		Hinge side:	Carcase depth	M10	M20	M30	M40	M50	M60	M70	M80	M90
Order no. W H D												
 <p><b>Tall unit visible side</b></p> <p>55.5 cm side depth Fixed dimension, not variable 57.5 cm side depth Fixed dimension, not variable 60.5 cm side depth Fixed dimension, not variable 61 cm side depth Fixed dimension, not variable</p>	<p><b>Important!</b> Installation instead of a normal unit side. Only available in the listed side depths. For other dimensions, use GSVT...</p>											
		<b>GSV 20</b>	R/L	0	0	143	143	191	191	260	319	-
		<b>GSV 20 5</b>	R/L	0	0	143	143	191	191	260	319	-
		<b>GSV 20 6</b>	R/L	0	0	143	143	191	191	260	319	-
 <p><b>Tall unit increased side depth</b></p> <p>from 61.1 cm up to 90 cm side depth Up to 60.9 cm side depth</p>	<p><b>Important!</b> Installation instead of a normal unit side.</p>											
		<b>GSVT 20</b>	R/L	88	118	312	312	416	416	568	666	-
		<b>GSVT 20 6</b>	R/L	45	58	208	208	277	277	378	465	-
<b>M 10</b>	<b>M 20</b>	<b>M 30</b>	<b>M 40</b>	<b>M 50</b>								
K M10 laminate	D M20 Laminate decor	I M30 RESOPAL PRO super matt IH M30 HPL PRO PW M30 PRIMEWOOD/Basic Veneer	A M40 DIRECTLACK matt L M40 DIRECTLACK high-gloss	B M50 Velvet lacquer P M50 Soft lacquer RH M50 Velvet lacquer wood texture RW M50 Velvet lacquer spackle effect S M50 microstructure lacquer								
<b>M 60</b>	<b>M 70</b>	<b>M 80</b>	<b>M 90</b>									
QH M60 SMARTGLAS high-gloss QM M60 SMARTGLAS satin-finish	F M70 veneer / oak / walnut V M70 Velvet lacquer textured Z M70 Veneer / Bavaria	C1 M80 FENIX stainless-steel look H M80 high gloss-Lacquer MP M80 laqué mat Premium O M80 Veneered										

**Shelf units 207.8 cm high**

Carcase depth 57.7 cm, flush with front

■ = = Models also available in 36.1/47.7/63.2 cm carcase depth (Order no.: replace ... 58 ... with 36/48/63)

 <p><b>Tall shelf unit</b></p> <p>1 fixed shelf 4 adjustable shelves</p> <p>wide in cm: 13-30 wide in cm: 30,1-40 wide in cm: 40,1-45 wide in cm: 45,1-50 wide in cm: 50,1-60</p>												
	<b>GR 30 20 58</b>	■	381	-	-	-	1488	-	1488	1488	-	
	<b>GR 40 20 58</b>	■	381	-	-	-	1488	-	1488	1488	-	
	<b>GR 45 20 58</b>	■	381	-	-	-	1488	-	1488	1488	-	
	<b>GR 50 20 58</b>	■	381	-	-	-	1488	-	1488	1488	-	
	<b>GR 60 20 58</b>	■	381	-	-	-	1488	-	1488	1488	-	
 <p><b>Tall shelf end unit</b></p> <p>25 x 57.7 cm 5 fixed shelves For adjacent fitting left or right</p>												
	<b>GRA 25 20 58</b>	R/L ■	465	-	-	-	1299	-	1299	1299	-	
 <p><b>Tall shelf end unit</b></p> <p>34 x 57.7 cm 5 fixed shelves For adjacent fitting left or right</p>												
	<b>GRA 34 20 58</b>	R/L ■	465	-	-	-	1490	-	1490	1490	-	

<b>M 10</b>	<b>M 20</b>	<b>M 30</b>	<b>M 40</b>	<b>M 50</b>								
K M10 laminate				B M50 Velvet lacquer S M50 microstructure lacquer								
<b>M 60</b>	<b>M 70</b>	<b>M 80</b>	<b>M 90</b>									
	F M70 veneer / oak / walnut Z M70 Veneer / Bavaria	H M80 high gloss-Lacquer MP M80 laqué mat Premium										

# Raised dishwashers

For carcass height 207.8 cm, carcass depth 55.5 cm

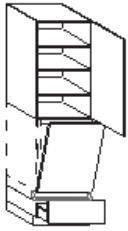
Pull-out panel at bottom 25.6 cm high



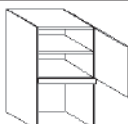

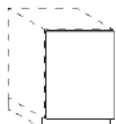


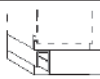


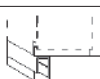

**Note:**

Do not plan at the end of a row. Only plan between tall units.

Always follow the assembly instructions from the appliance manufacturers.

▲ = Types also available with 61 cm carcass depth (order no. ... replace ... 55 ... with 61)



Order no. W H D		Hinge side: Carcass depth	Price groups									
			1	2	3	4	5	6	7	8	9	
1036	 <p><b>Dresser unit above raised dishwasher</b> Height 105.3 cm 1 door 103.6 cm 3 adjustable shelves 1 vapour protector</p>	A 60 10 55	R/L ▲	317	331	354	441	502	532	586	645	-
516 516	 <p><b>Dresser unit with lifting door for microwave above raised dishwasher</b> Height 105.3 cm 1 door 51.6 cm 1 lifting door with front 51.6 cm 1 adjustable shelf 1 vapour protector</p>	ALT 60 10 55	R/L ▲	471	498	510	596	646	672	759	835	-
516	 <p><b>Dresser unit for microwave above raised dishwasher</b> Height 105.3 cm 1 door 51.6 cm 1 panel 1 appliance aperture 35 - 45 cm 1 adjustable shelf 1 vapour protector</p>	35,0-45,0										
			 <b>Not available for:</b> ALU TEC RP, MIAMI, VIVA									
		AN 60 10 55 2	R/L ▲	317	331	354	441	502	532	586	645	-
		AN 60 10 55 2A	R/L ▲	317	331	354	441	502	532	586	645	-
776	 <p><b>Base unit door, 77.6 cm</b> 59.6 cm wide As front panel for fully integrated dishwashers 86 cm high and pull-out fridges and freezers 59.6 cm wide with 60 cm</p>			 <i>Always order article DL 60 6 if a high-volume dishwasher has not been included in planning!</i>								
		UT 60 78 1		122	126	138	146	232	253	294	323	-
	 <p><b>Spacer strips for fully integrated dishwasher</b> Appliance height 82 cm 2 spacer strips Colour: Art Pepper 6 cm high</p>	DL 60 6		32								
256	 <p><b>Base for raised dishwasher (86 cm high)</b> with top shelf, 15.5 cm high 1 drawer with pull-out panel 25.6 cm, 45.5 cm deep angled at top 1 collection tray (available only in 60 cm width)</p>	UGS 60 10 55 87	▲	276	290	320	378	412	439	480	528	-
			 <b>Not available for:</b> ALU TEC RP									
			 <b>Important!</b> Plan free-standing with 25 mm panels									
256	 <p><b>Base for raised dishwasher (86 cm high)</b> only for dishwashers with VARIO HINGE with top shelf, 15.5 cm high 1 drawer with pull-out panel 25.6 cm not angled 45.5 cm deep 1 collection tray (available only in 60 cm width)</p>	UGV 60 10 55 87	▲	276	290	320	378	412	439	480	528	-
			 <b>Important!</b> Plan free-standing with 25 mm panels									

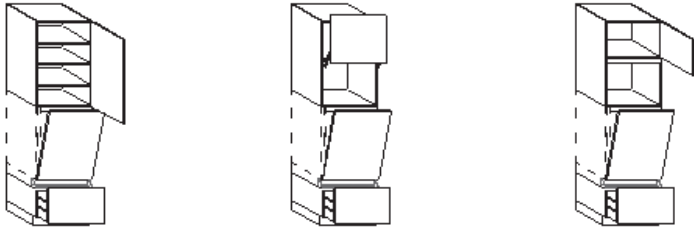
# Raised dishwashers

For carcass height 207.8 cm, carcass depth 55.5 cm

Pull-out panel at bottom 38.6 cm high

**Note:**

Do not plan at the end of a row. Only plan between tall units.  
Always follow the assembly instructions from the appliance manufacturers.  
▲ = Types also available with 61 cm carcass depth (order no. ... replace ... 55 ... with 61)



			Price groups											
Order no.			Hinge side:	Carcass depth	1	2	3	4	5	6	7	8	9	
W	H	D												
906		<b>Dresser unit above raised dishwasher</b> Height 92.3 cm 1 door 90.6 cm 3 adjustable shelves 1 vapour protector	A	60 92 55	R/L ▲	265	279	298	369	418	444	489	538	-
386 516		<b>Dresser unit with lifting door for microwave above raised dishwasher</b> Height 92.3 cm 1 door 38.6 cm 1 lifting door with front 51.6 cm 1 vapour protector	ALT	60 92 55	R/L ▲	422	432	451	523	564	583	658	724	-
386		<b>Dresser unit for microwave above raised dishwasher</b> Height 92.3 cm 1 door 38.6 cm 1 panel 1 appliance aperture 35 - 45 cm 1 vapour protector												
			<div style="border: 1px solid black; padding: 2px; display: inline-block;">35,0-45,0</div>											
			<div style="border: 1px solid black; padding: 2px; display: inline-block;">Not available for: ALU TEC RP, MIAMI, VIVA</div>											
			AN	60 92 55 2	R/L ▲	265	279	298	369	418	444	489	538	-
			AN	60 92 55 2A	R/L ▲	265	279	298	369	418	444	489	538	-
776		<b>Base unit door, 77.6 cm</b> 59.6 cm wide As front panel for fully integrated dishwashers 86 cm high and pull-out fridges and freezers 59.6 cm wide with 60 cm												
			<div style="border: 1px solid black; padding: 2px; display: inline-block;">Always order article DL 60 6 if a high-volume dishwasher has not been included in planning!</div>											
		<b>Spacer strips for fully integrated dishwasher</b> Appliance height 82 cm 2 spacer strips Colour: Art Pepper 6 cm high	DL	60 6		32								
386		<b>Base for raised dishwasher (86 cm high)</b> with top shelf, 28.5 cm high 1 pull-out 38.6 cm, 45.5 cm deep angled at top 1 collection tray (available only in 60 cm width)	UGS	60 11 55 87	▲	285	298	326	389	419	445	485	534	-
			<div style="border: 1px solid black; padding: 2px; display: inline-block;">Not available for: ALU TEC RP</div>											
			<div style="border: 1px solid black; padding: 2px; display: inline-block;">Important! Plan free-standing with 25 mm panels</div>											
386		<b>Base for raised dishwasher (86 cm high)</b> only for dishwashers with <b>VARIO HINGE</b> with top shelf, 28.5 cm high 1 pull-out panel 38.6 cm, 45.5 cm deep not angled 1 collection tray (available only in 60 cm width)	UGV	60 11 55 87	▲	285	298	326	389	419	445	485	534	-
			<div style="border: 1px solid black; padding: 2px; display: inline-block;">Important! Plan free-standing with 25 mm panels</div>											

# Raised dishwashers

For carcass height 207.8 cm, carcass depth 55.5 cm

Pull-out panel at bottom 32.1 cm high

**Note:**

Do not plan at the end of a row. Only plan between tall units.

Always follow the assembly instructions from the appliance manufacturers.

▲ = Types also available with 61 cm carcass depth (order no. ... replace ... 55 ... with 61)



Order no. W H D		Hinge side: R/L ▲	Carcass depth	Price groups									
				1	2	3	4	5	6	7	8	9	
321 646	<b>Dresser unit above raised dishwasher</b> Height 98.8 cm 1 flap door 32.1 cm 1 door 64.6 cm 2 adjustable shelves 1 vapour protector	A	60 98 55	R/L ▲	331	342	377	454	493	522	570	627	-
581 386	<b>Dresser unit with lifting door for microwave above raised dishwasher</b> Height 98.8 cm 1 door 58.1 cm 1 lifting door with front 38.6 cm 1 adjustable shelf 1 vapour protector	ALT	60 98 55	R/L ▲	479	506	524	601	626	647	731	804	-
776	<b>Base unit door, 77.6 cm</b> 59.6 cm wide As front panel for fully integrated dishwashers 86 cm high and pull-out fridges and freezers 59.6 cm wide with 60 cm	UT	60 78 1	▲	Always order article DL 60 6 if a high-volume dishwasher has not been included in planning!								
					122	126	138	146	232	253	294	323	-
	<b>Spacer strips for fully integrated dishwasher</b> Appliance height 82 cm 2 spacer strips Colour: Art Pepper 6 cm high	DL	60 6		32								
321	<b>Base for raised dishwasher</b> with top shelf, 22.0 cm high 1 drawer with pull-out panel 32.1 cm, 45.5 cm deep, angled at top 1 collection tray (available only in 60 cm width)	UGS	60 15 55 871	▲	276	290	320	378	412	439	480	528	-
					Width 60 Not available for: ALU TEC RP, MIAMI, VIVA Important! Plan free-standing with 25 mm panels								
	<b>Base for raised dishwasher</b> only for dishwashers with VARIO HINGE with top shelf, 22.0 cm high 1 drawer with pull-out panel 32.1 cm, 45.5 cm deep, not chamfered 1 collection tray (available only in 60 cm width)	UGV	60 15 55 871	▲	276	290	320	378	412	439	480	528	-
					Width 60 Not available for: MIAMI, VIVA Important! Plan free-standing with 25 mm panels								
	<b>Vapour protector for raised dishwashers</b> Finish: metal to protect the fronts above	WSB-45	WSB-60		11								
					12								

# Raised dishwashers

For carcass height 207.8 cm, carcass depth 55.5 cm

Pull-out panel at bottom 45.1 cm high

**Note:**

Do not plan at the end of a row. Only plan between tall units.

Always follow the assembly instructions from the appliance manufacturers.

▲ = Types also available with 61 cm carcass depth (order no. ... replace ... 55 ... with 61)



		Order no.		Hinge side: R/L ▲	Carcass depth	Price groups										
		W	H			D	1	2	3	4	5	6	7	8	9	
321 516	<p><b>Dresser unit above raised dishwasher</b> Height 85.8 cm 1 flap door 32.1 cm 1 door 51.6 cm 1 adjustable shelf 1 vapour protector</p>	<b>A</b>	<b>60</b>	<b>85</b>	<b>55</b>	▲	318	330	360	437	470	502	547	602	-	
		Width 60 Not available for: MIAMI, VIVA														
321 516	<p><b>Dresser unit with lifting door for microwave above raised dishwasher</b> Height 85.8 cm 1 flap door 32.1 cm 1 lifting door with front 51.6 cm 1 vapour protector</p>	<b>ALT</b>	<b>60</b>	<b>85</b>	<b>55</b>	▲	473	496	515	589	616	639	718	790	-	
		Width 60 Not available for: MIAMI, VIVA														
321	<p><b>Dresser unit for microwave above raised dishwasher</b> Height 85.8 cm 1 flap door 32.1 cm 1 panel 1 appliance aperture 35 - 45 cm 1 vapour protector</p>	<b>AN</b>	<b>60</b>	<b>85</b>	<b>55</b>	<b>2</b>	▲	318	330	360	437	470	502	547	602	-
		<b>AN</b>	<b>60</b>	<b>85</b>	<b>55</b>	<b>2A</b>	▲	318	330	360	437	470	502	547	602	-
		Not available for: ALU TEC RP, MIAMI, VIVA														
776	<p><b>Base unit door, 77.6 cm</b> 59.6 cm wide As front panel for fully integrated dishwashers 86 cm high and pull-out fridges and freezers 59.6 cm wide with 60 cm</p>															
		Always order article DL 60 6 if a high-volume dishwasher has not been included in planning!														
	<p><b>Spacer strips for fully integrated dishwasher</b> Appliance height 82 cm 2 spacer strips Colour: Art Pepper 6 cm high</p>	<b>DL</b>	<b>60</b>	<b>6</b>			32									
451	<p><b>Base for raised dishwasher (86 cm high)</b> with top shelf, 35.0 cm high 1 pull-out 45.1 cm, 45.5 cm deep angled at top 1 collection tray (available only in 60 cm width)</p>	<b>UGS</b>	<b>60</b>	<b>12</b>	<b>55</b>	<b>87</b>	▲	295	306	337	401	431	459	500	550	-
		Width 60 Not available for: ALU TEC RP														
		Important! Plan free-standing with 25 mm panels														
451	<p><b>Base for raised dishwasher (86 cm high)</b> only for dishwashers with <b>VARIO HINGE</b> with top shelf, 35.0 cm high 1 pull-out panel 45.1 cm, 45.5 cm deep not angled 1 collection tray (available only in 60 cm width)</p>	<b>UGV</b>	<b>60</b>	<b>12</b>	<b>55</b>	<b>87</b>	▲	295	306	337	401	431	459	500	550	-
		Width 60 Not available for: ALU TEC RP														
		Important! Plan free-standing with 25 mm panels														
	<p><b>Vapour protector for raised dishwashers</b> Finish: metal to protect the fronts above</p>	<b>WSB-45</b>					11									
		<b>WSB-60</b>					12									

# 6.7

## Tall units 220.8 cm

Tall units 220.8 cm high	XL 6.7.4-XL 6.7.9
Tall units 220.8 cm high with glass fronts	XL 6.7.10
Additional equipment	XL 6.7.10
Tall units 220.8 cm high with roller shutter	XL 6.7.10-XL 6.7.11
Appliance unit 220.8 cm high for microwave / oven	XL 6.7.11-XL 6.7.14
Appliance unit 220.8 cm high for microwave / oven Double aperture	XL 6.7.14-XL 6.7.17
Appliance unit 220.8 cm high for microwave / oven Lifting door / aperture	XL 6.7.17-XL 6.7.18
Appliance unit 220.8 cm high for microwave / oven 30 inches wide (76.2 cm)	XL 6.7.18-XL 6.7.19
Appliance unit 220.8 cm high for refrigerator/freezer	XL 6.7.19-XL 6.7.22
Appliance unit 220.8 cm high for refrigerator/freezer Double aperture	XL 6.7.23
Tall units 220.8 cm high Widths: 75 cm	XL 6.7.23
Fronts for Side by Side refrigerators/freezers 220.8 cm high	XL 6.7.24
spacefitter frame 220.8 cm high	XL 6.7.24-XL 6.7.25
Passage door elements	XL 6.7.25-XL 6.7.26
Front filler 220.8 cm high	XL 6.7.27
Back cladding 220.8 cm high with screw-fitted fronts	XL 6.7.27
Back cladding 220.8 cm high	XL 6.7.27
Visible sides / increased side depth 220.8 cm high	XL 6.7.28
Shelf units 220.8 cm high	XL 6.7.28
Raised dishwashers For carcass height 220.8 cm, carcass depth 55.5 cm	XL 6.7.29
Raised dishwashers For carcass height 220.8 cm, carcass depth 55.5 cm	XL 6.7.30
Raised dishwashers For carcass height 220.8 cm, carcass depth 55.5 cm	XL 6.7.31
Raised dishwashers For carcass height 220.8 cm, carcass depth 55.5 cm	XL 6.7.32

### Legend:



Available with grip ledge N...



Not available with grip ledge N...



This symbol indicates which models are available



This symbol indicates which models are not available



wall-mounted units



available depths for wall-mounted units



Planning advice



This symbol illustrates which appliance units are delivered with integrated ventilation



Not available with „push-to-open“ fitting



Aperture height specifications



Available carcass depths 34/45.5/55.5/61.0 cm

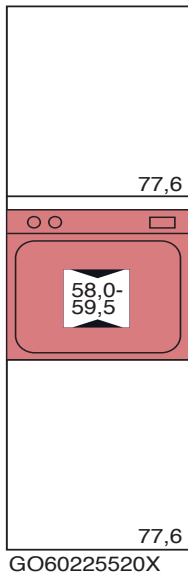


Available carcass depths 45.5/55.5/61.0 cm



Available carcass depths 55.5/61.0 cm

## Planning advice for appliance shelves with compensation panels or compensation door



Door

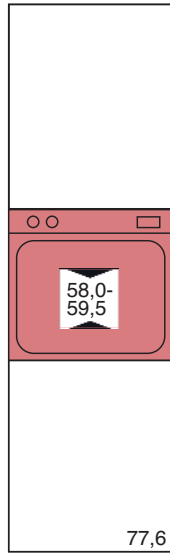
Compensation panel

77,6

58,0-  
59,5

77,6

GO60225520X



Compensation door  
77,6 cm + compensation panel

By changing the order number, the compensation panels above the appliance apertures can be replaced by a special-size door or lifting door.

Advantages:

- Full use can be made of the storage space above the appliance aperture
- Reduction of horizontal joints



**Not available for models:  
MIAMI, VIVA**

GO602220XA

Height  
220,8 cm

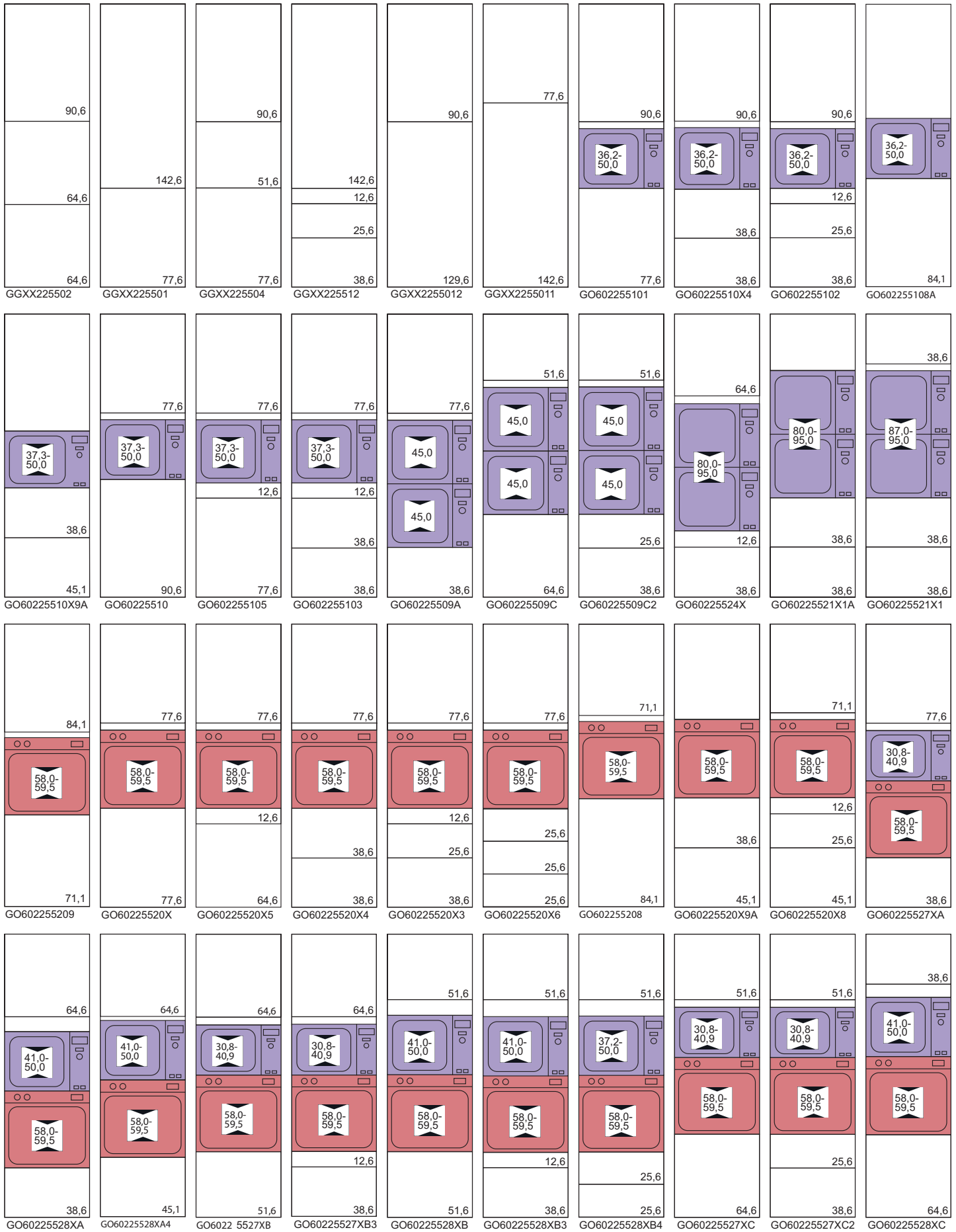


# The most important tall unit types 220.8 cm high

Page XL 6.7.4	Page XL 6.7.4	Page XL 6.7.4	Page XL 6.7.4	Page XL 6.7.4	Page XL 6.7.4	Page XL 6.7.4	Page XL 6.7.4	Page XL 6.7.4
<b>GGs..225502</b> Unit widths: 25	<b>GGs..225501</b> Unit widths: 25	<b>GGs..225504</b> Unit widths: 25	<b>GVSTP..225502</b> Unit widths: 25	<b>GVSTP..225501</b> Unit widths: 25	<b>GV..225502</b> Unit widths: 30/45	<b>GV..225501</b> Unit widths: 30/45	<b>GV..225504</b> Unit widths: 30/45	<b>GV..225570</b> Unit widths: 30/45
Page XL 6.7.4	Page XL 6.7.5	Page XL 6.7.5	Page XL 6.7.5	Page XL 6.7.5	Page XL 6.7.5	Page XL 6.7.5	Page XL 6.7.5	Page XL 6.7.5
<b>GVP..225502</b> Unit widths: 30/45	<b>GVP..225501</b> Unit widths: 30/45	<b>GVP..225504</b> Unit widths: 30/45	<b>GVP..225570</b> Unit widths: 30/45	<b>GV..225502</b> Unit widths: 50/60	<b>GVP..225501</b> Unit widths: 50/60	<b>GVP..0225501</b> Unit widths: 100	<b>GV..225501</b> Unit widths: 50/60	<b>GV..225504</b> Unit widths: 50/60
Page XL 6.7.5	Page XL 6.7.5	Page XL 6.7.6	Page XL 6.7.6	Page XL 6.7.6	Page XL 6.7.6	Page XL 6.7.6	Page XL 6.7.6	Page XL 6.7.6
<b>GVPS..2255</b> Unit widths: 60	<b>GVPT..225501</b> Unit widths: 50/60	<b>GVT..225501</b> Unit widths: 50/60	<b>GG..225502</b> Unit widths: 30/40/45/50/60	<b>GG..225507</b> Unit widths: 30/40/45/50/60	<b>GG..225501</b> Unit widths: 30/40/45/50/60	<b>GG..225501</b> Unit widths: 80/90	<b>GG..225504</b> Unit widths: 30/40/45/50/60	<b>GGA..225508</b> Unit widths: 30/40/45/50/60
Page XL 6.7.6	Page XL 6.7.6	Page XL 6.7.7	Page XL 6.7.7	Page XL 6.7.7	Page XL 6.7.7	Page XL 6.7.7	Page XL 6.7.7	Page XL 6.7.7
<b>GGA..225502</b> Unit widths: 30/40/45/50/60	<b>GGA..225503</b> Unit widths: 90	<b>GGA..225501</b> Unit widths: 30/40/45/50/60	<b>GG..225573</b> Unit widths: 30/40/45/50/60	<b>GG..225512</b> Unit widths: 30/40/45/50/60	<b>GGA..225502</b> Unit widths: 90/100	<b>GG..225505</b> Unit widths: 30/40/45/50/60	<b>GGA..2255081</b> Unit widths: 30/40/45/50/60	<b>GGA..225506</b> Unit widths: 30/40/45/50/60
Page XL 6.7.7	Page XL 6.7.7	Page XL 6.7.8	Page XL 6.7.8	Page XL 6.7.8	Page XL 6.7.8	Page XL 6.7.8	Page XL 6.7.8	Page XL 6.7.8
<b>GG..2255011</b> Unit widths: 30/40/45/50/60	<b>GG..2255012</b> Unit widths: 30/40/45/50/60	<b>GG..225570</b> Unit widths: 30/40/45/50/60	<b>GGA..225571</b> Unit widths: 30/40/45/50/60	<b>GGA..225572</b> Unit widths: 30/40/45/50/60	<b>GB..225502</b> Unit widths: 30/40/45/50/60	<b>GB..225501</b> Unit widths: 30/40/45/50/60	<b>GB..225504</b> Unit widths: 30/40/45/50/60	<b>GB..225570</b> Unit widths: 30/40/45/50/60
Page XL 6.7.9	Page XL 6.7.9	Page XL 6.7.9	Page XL 6.7.9	Page XL 6.7.9	Page XL 6.7.9	Page XL 6.7.9	Page XL 6.7.11	Page XL 6.7.24
<b>GB..225512</b> Unit widths: 40/45/50/60	<b>GB..225511</b> Unit widths: 40/45/50/60	<b>GB..225514</b> Unit widths: 40/45/50/60	<b>GB..2255011</b> Unit widths: 40/45/50/60	<b>GB..225571</b> Unit widths: 40/45/50/60	<b>GK..226170</b> Unit widths: 45/50/60	<b>GK..226170</b> Unit widths: 90/100	<b>TAB-AZ..55</b> Unit widths: 45/50/60/80/90	<b>GPR..221001</b> Unit widths: 30/45/50/60



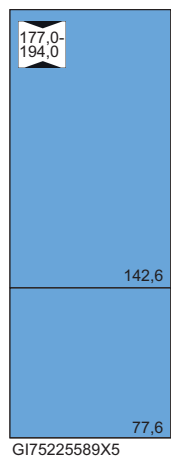
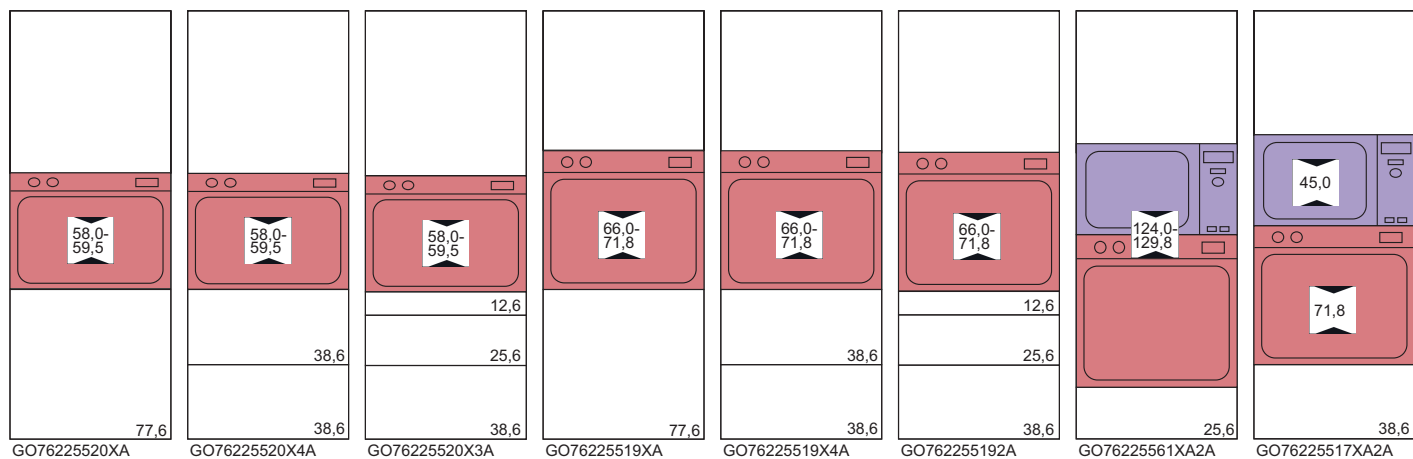
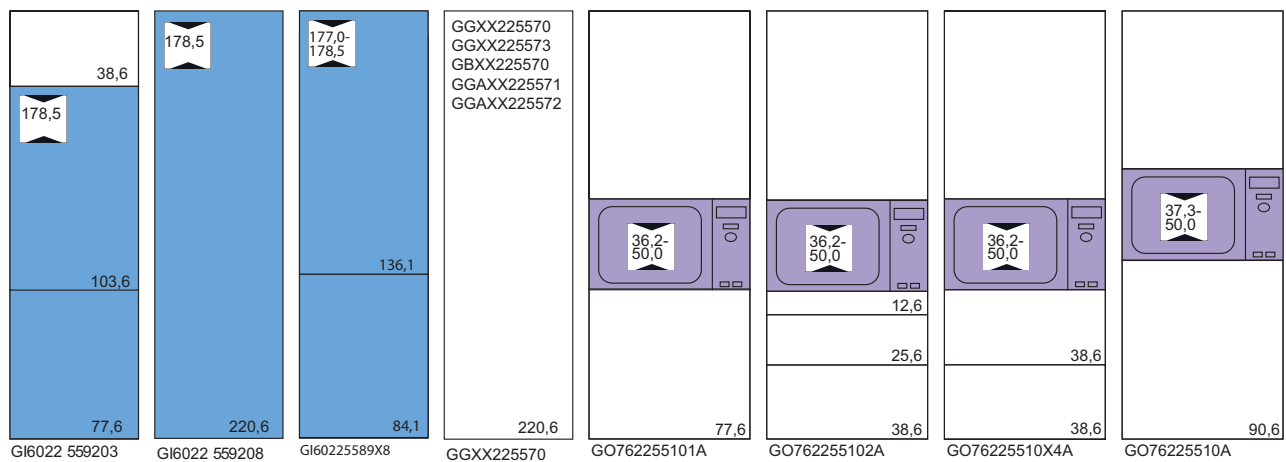
# Recess overview Tall units 220.8 cm



# Recess overview Tall units 220.8 cm



# Recess overview Tall units 220.8 cm



# Tall units 220.8 cm high

Carcase depth 55.5 cm (standard)

- = Models also available in 34/45.5/61 cm carcass depth (Order no.: ... replace ... 55 ... with 34/45/61)
- = Models also available in 45.5/61 cm carcass depth (order no.: replace ... 55 ... with 45/61)
- ▲ = Types also available with 61 cm carcass depth (order no. ... replace ... 55 ... with 61)

Order no.  
W H D

Hinge side:	Carcass depth	Price groups								
		1	2	3	4	5	6	7	8	9
R/L	■	599	615	668	806	862	893	957	1053	-
R/L	■	577	589	643	783	843	867	932	1025	-
R/L	■	599	615	668	806	862	893	957	1053	-
R/L	▲	1363	1379	1427	1541	1597	1622	1684	1852	-
R/L	▲	1339	1355	1402	1519	1572	1602	1662	1828	-
R/L	▲	1363	1379	1427	1541	1597	1622	1684	1852	-
	▲	958	983	1004	1187	1237	1282	1370	1507	-
	▲	975	1004	1061	1244	1313	1353	1453	1598	-
	▲	932	964	979	1163	1217	1260	1347	1482	-
	▲	975	1004	1061	1244	1313	1353	1453	1598	-
	▲	958	983	1004	1187	1237	1282	1370	1507	-
	▲	975	1004	1061	1244	1313	1353	1453	1598	-
	▲	1014	1043	1062	1244	1296	1342	1430	1573	-
	▲	1057	1084	1141	1325	1394	1435	1534	1687	-
Width 30, 45 Not available for: ALUELEMENTS, ATLANTA-B, ATLANTA-S, BERGEN, CASTELLO, CHALET-B, CHALET-S, CHICAGO, FRAME, GARDA, LUGANO, LUX-B, MIAMI, MODENA, MUNICH, NEVADA, NOBEL-B, NOBEL-S, ORLANDO-B, ORLANDO-S, OSLO 15, PADUA, SOFIE-B, SOFIE-S, TESSIN 15, TIM 15, TREND, VINO, VIVA, YORK-B, YORK-S										
	▲	1207	1233	1253	1432	1482	1526	1615	1777	-
	▲	1213	1239	1295	1473	1544	1584	1684	1852	-

**Crockery cupboard angled 37.2°**  
 1 door 90.6 cm connected to 1 door 64.6 cm  
 1 door 64.6 cm  
 1 fixed shelf  
 6 adjustable shelves  
 For adjacent fitting left or right

Ill. left

**Crockery cupboard angled 37.2°**  
 1 door 142.6 cm  
 1 door 77.6 cm  
 1 fixed shelf  
 6 adjustable shelves  
 For adjacent fitting left or right

Ill. left

**Crockery cupboard angled 37.2°**  
 1 door 90.6 cm connected to 1 door 51.6 cm  
 1 door 77.6 cm  
 1 fixed shelf  
 6 adjustable shelves  
 For adjacent fitting left or right

Ill. left

**Larder unit angled 37.2°**  
 1 door 90.6 cm with 1 door 64.6 cm connected to 1 door 64.6 cm  
 1 pull-out element  
 6 adjustable wooden shelves with chrome-plated square rail  
 For adjacent fitting left or right

Ill. left

**Larder unit angled 37.2°**  
 1 door 142.6 cm connected to 1 door 77.6 cm  
 1 pull-out element  
 6 adjustable wooden shelves with chrome-plated square rail  
 For adjacent fitting left or right

Ill. left

**Larder unit angled 37.2°**  
 1 door 90.6 cm with 1 door 51.6 cm connected to 1 door 77.6 cm  
 1 pull-out element  
 6 adjustable wooden shelves with chrome-plated square rail  
 For adjacent fitting left or right

Ill. left

**Larder unit**  
 1 pull-out  
 1 door 90.6 cm with 1 door 64.6 cm connected to 1 door 64.6 cm  
 on telescopic rails, full height can be pulled out  
 With 6 adjustable wire baskets (chrome-plated)  
 Open top compartment 11.0 cm

Ill. left

**Larder unit**  
 1 pull-out  
 1 door 142.6 cm connected to 1 door 77.6 cm on telescopic rails Full height can be pulled out  
 With 6 adjustable wire baskets (chrome-plated)  
 Open top compartment 11.0 cm

Ill. left

**Larder unit**  
 1 pull-out  
 1 door 90.6 cm with 1 door 51.6 cm connected to 1 door 77.6 cm  
 on telescopic rails, full height can be pulled out  
 With 6 adjustable wire baskets (chrome-plated)  
 Open top compartment 11.0 cm

Ill. left

**Larder unit**  
 1 pull-out 220.6 cm  
 on telescopic rails, full height can be pulled out  
 With 6 adjustable wire baskets (chrome-plated)  
 Open top compartment 11.0 cm

Ill. left

**Larder unit**  
 1 pull-out  
 1 door 90.6 cm with 1 door 64.6 cm connected to 1 door 64.6 cm  
 on telescopic rails, full height can be pulled out  
 With 6 adjustable wooden shelves with chrome-plated, square rail  
 Open top compartment 11.0 cm

Ill. left

# Tall units 220.8 cm high

Carcase depth 55.5 cm (standard)

■ = Models also available in 34/45.5/61 cm carcass depth (Order no.: ... replace ... 55 ... with 34/45/61)  
 □ = Models also available in 45.5/61 cm carcass depth (order no.: replace ... 55 ... with 45/61)  
 ▲ = Types also available with 61 cm carcass depth (order no.: ... replace ... 55 ... with 61)

Order no.  
W H D

Hinge side: Carcass depth	Price groups												
	1	2	3	4	5	6	7	8	9				
78	<b>Larder unit</b> 1 pull-out 1 door 142.6 cm connected to 1 door 77.6 cm on telescopic rails, full height can be pulled out With 6 adjustable wooden shelves with chrome-plated, square rail Open top compartment 11.0 cm		GVP 30 22 55 01 GVP 45 22 55 01	▲	1184	1212	1230	1406	1460	1504	1592	1751	-
				▲	1213	1239	1295	1473	1543	1584	1684	1852	-
78	<b>Larder unit</b> 1 pull-out 1 door 90.6 cm with 1 door 51.6 cm connected to 1 door 77.6 cm on telescopic rails, full height can be pulled out With 6 adjustable wooden shelves with chrome-plated, square rail Open top compartment 11.0 cm		GVP 30 22 55 04 GVP 45 22 55 04	▲	1207	1233	1253	1432	1482	1526	1615	1777	-
				▲	1213	1239	1295	1473	1543	1584	1684	1852	-
N.L.	<b>Larder unit</b> 1 pull-out 220.6 cm on telescopic rails, full height can be pulled out With 6 adjustable wooden shelves with chrome-plated, square rail Open top compartment 11.0 cm		GVP 30 22 55 70 GVP 45 22 55 70	▲	1266	1292	1312	1487	1541	1584	1673	1840	-
				▲	1293	1321	1379	1555	1624	1667	1765	1942	-
Width 30, 45 Not available for: ALUELEMENTS, ATLANTA-B, ATLANTA-S, BERGEN, CASTELLO, CHALET-B, CHALET-S, CHICAGO, FRAME, GARDA, LUGANO, LUX-B, MIAMI, MODENA, MUNICH, NEVADA, NOBEL-B, NOBEL-S, ORLANDO-B, ORLANDO-S, OSLO 15, PADUA, SOFIE-B, SOFIE-S, TESSIN 15, TIM 15, TREND, VINO, VIVA, YORK-B, YORK-S													
R/L	<b>Larder unit</b> 1 door 90.6 cm with 1 door 64.6 cm connected to 1 door 64.6 cm 1 swivel and pull-out element 1 fixed shelf 6 adjustable and 6 removable wire baskets (chrome-plated) Open top compartment 29.1 cm		GV 50 22 55 02 GV 60 22 55 02	▲	1619	1632	1684	1784	1830	1858	1920	2112	-
				▲	1700	1714	1773	1928	1984	2020	2092	2301	-
78	<b>Larder unit</b> 1 door 142.6 cm connected to 1 door 77.6 cm 1 fixed shelf 1 swivel and pull-out element 6 adjustable and 6 adjustable wooden shelves with chrome-plated square rail Open top compartment 29.1 cm		GVP 50 22 55 01 GVP 60 22 55 01	R/L ▲	1973	1986	2037	2131	2175	2204	2266	2493	-
				R/L ▲	2103	2117	2175	2321	2377	2412	2484	2732	-
78	<b>Larder unit</b> 2 doors 142.6 cm connected with 2 doors 77.6 cm 2 swivel and pull-out elements each 6 adjustable and each connected with 6 adjustable wooden shelves with chrome-plated square rail 1 fixed shelf Open top compartment 29.1 cm		GVP 100 22 55 01	▲	3933	3961	4065	4247	4339	4397	4519	4971	-
R/L	<b>Larder unit</b> 1 door 142.6 cm connected to 1 door 77.6 cm 1 swivel and pull-out element 1 fixed shelf 6 adjustable and 6 removable wire baskets (chrome-plated) Open top compartment 29.1 cm		GV 50 22 55 01 GV 60 22 55 01	▲	1595	1609	1660	1761	1806	1835	1895	2085	-
				▲	1700	1714	1773	1928	1984	2020	2092	2301	-
R/L	<b>Larder unit</b> 1 door 90.6 cm with 1 door 51.6 cm connected to 1 door 77.6 cm 1 swivel and pull-out element 1 fixed shelf 6 adjustable and 6 removable wire baskets (chrome-plated) Open top compartment 29.1 cm		GV 50 22 55 04 GV 60 22 55 04	▲	1619	1632	1684	1784	1830	1858	1920	2112	-
				▲	1700	1714	1773	1928	1984	2020	2092	2301	-
R/L	<b>Larder unit</b> 1 door 142.6 cm connected to 1 door 77.6 cm 1 fixed shelf 1 pull-out element 6 adjustable wooden shelves with chrome-plated square rail Open top compartment 29.1 cm		GVPS 60 22 55	▲	1559	1579	1641	1877	1936	1974	2053	2258	-
R/L	<b>Larder unit</b> 1 door 142.6 cm connected to 1 door 77.6 cm 6 wooden shelves with chrome-plated square rail Adjustable in height 7 adjustable shelves reduced in depth		GVPT 50 22 55 01 GVPT 60 22 55 01	▲	958	971	1027	1220	1270	1299	1364	1500	-
				▲	1024	1037	1098	1347	1406	1441	1518	1670	-
⚡ The adjustable shelves will be delivered as a separate package.													





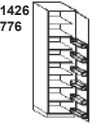
# Tall units 220.8 cm high

Carcase depth 55.5 cm (standard)

■ = Models also available in 34/45.5/61 cm carcass depth (Order no.: ... replace ... 55 ... with 34/45/61)  
 □ = Models also available in 45.5/61 cm carcass depth (order no.: replace ... 55 ... with 45/61)  
 ▲ = Types also available with 61 cm carcass depth (order no. ... replace ... 55 ... with 61)

Order no.  
W H D

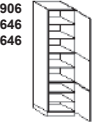
Hinge side:	Carcass depth	Price groups														
		1	2	3	4	5	6	7	8	9						
R/L ▲	77.6	78	GVT	50	22	55	01	906	919	975	1168	1218	1249	1313	1444	-
								973	986	1047	1296	1355	1391	1466	1613	-
 The adjustable shelves will be delivered as a separate package.																
R/L ■	64.6	78	GG	30	22	55	02	412	424	483	630	694	721	790	869	-
								412	424	483	630	694	721	790	869	-
								412	424	483	630	694	721	790	869	-
								412	424	483	690	737	772	838	922	-
								451	473	532	792	855	893	971	1068	-
R/L ■	71.1	71,5	GG	30	22	55	07	385	407	460	610	669	701	769	846	-
								385	407	460	610	669	701	769	846	-
								385	407	460	610	669	701	769	846	-
								385	407	460	665	716	746	814	895	-
								427	447	508	772	831	867	949	1044	-
 Width 30, 40, 45, 50, 60 Not available for: MIAMI, VIVA																
R/L ■	77.6	78	GG	30	22	55	01	385	407	460	610	669	701	769	846	-
								385	407	460	610	669	701	769	846	-
								385	407	460	610	669	701	769	846	-
								385	407	460	665	716	746	814	895	-
								427	447	508	772	831	867	949	1044	-
■	77.6	78	GG	80	22	55	01	875	909	1006	1165	1229	1287	1393	1532	-
								875	909	1006	1165	1229	1287	1393	1532	-
R/L ■	51.6	78	GG	30	22	55	04	412	424	483	630	694	721	790	869	-
								412	424	483	630	694	721	790	869	-
								412	424	483	630	694	721	790	869	-
								412	424	483	690	737	772	838	922	-
								451	473	532	792	855	893	971	1068	-
R/L ■	77.6	78	GGA	30	22	55	08	768	780	839	986	1050	1077	1146	1261	-
								768	780	839	986	1050	1077	1146	1261	-
								768	780	839	986	1050	1077	1146	1261	-
								768	780	839	1046	1093	1128	1194	1313	-
								807	829	888	1148	1211	1249	1327	1460	-
Planning advice: Doors with wide angle hinges may not be planned alongside units or panels if the protrusion to the front of the adjoining article is greater than 3 cm (hinge side). Doors with wide angle hinges protrude over the carcass side.																
R/L ■	77.6	78	GGA	30	22	55	02	1035	1055	1108	1243	1303	1336	1402	1542	-
								1074	1092	1145	1280	1342	1373	1439	1583	-
								1074	1092	1145	1280	1342	1373	1439	1583	-
								1089	1109	1160	1350	1401	1433	1501	1651	-
								1151	1174	1233	1478	1540	1576	1657	1823	-
Planning advice: Doors with wide angle hinges may not be planned alongside units or panels if the protrusion to the front of the adjoining article is greater than 3 cm (hinge side). Doors with wide angle hinges protrude over the carcass side.																
■	77.6	78	GGA	90	22	55	03	1709	1750	1853	2134	2256	2317	2453	2698	-
								1709	1750	1853	2134	2256	2317	2453	2698	-



**Larder unit**  
 1 door 142.6 cm connected to 1 door 77.6 cm  
 6 chrome-plated wire baskets  
 Adjustable in height  
 7 adjustable shelves reduced in depth

78

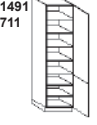
GVT 50 22 55 01  
 GVT 60 22 55 01



**Crockery cupboard**  
 1 door 90.6 cm connected to 1 door 64.6 cm  
 1 door 64.6 cm  
 1 fixed shelf  
 6 adjustable shelves

78

GG 30 22 55 02  
 GG 40 22 55 02  
 GG 45 22 55 02  
 GG 50 22 55 02  
 GG 60 22 55 02

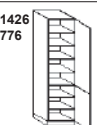


**Crockery cupboard**  
 1 door 149.1 cm  
 1 door 71.1 cm  
 1 fixed shelf  
 6 adjustable shelves

71,5

NEW

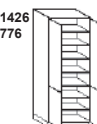
GG 30 22 55 07  
 GG 40 22 55 07  
 GG 45 22 55 07  
 GG 50 22 55 07  
 GG 60 22 55 07



**Crockery cupboard**  
 1 door 142.6 cm  
 1 door 77.6 cm  
 1 fixed shelf  
 6 adjustable shelves

78

GG 30 22 55 01  
 GG 40 22 55 01  
 GG 45 22 55 01  
 GG 50 22 55 01  
 GG 60 22 55 01



**Crockery cupboard**  
 2 doors 142.6 cm  
 2 doors 77.6 cm  
 1 fixed shelf  
 6 adjustable shelves

78

GG 80 22 55 01  
 GG 90 22 55 01



**Crockery cupboard**  
 1 door 90.6 cm connected to 1 door 51.6 cm  
 1 door 77.6 cm  
 1 fixed shelf  
 6 adjustable shelves

78

GG 30 22 55 04  
 GG 40 22 55 04  
 GG 45 22 55 04  
 GG 50 22 55 04  
 GG 60 22 55 04



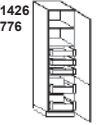
**Crockery cupboard**  
 1 door 142.6 cm  
 4 adjustable shelves  
 1 fixed shelf  
 1 door 77.6 cm with wide angle hinges  
 2 internal pull-outs

78

NEW

GGA 30 22 55 08  
 GGA 40 22 55 08  
 GGA 45 22 55 08  
 GGA 50 22 55 08  
 GGA 60 22 55 08

Planning advice:  
 Doors with wide angle hinges may not be planned alongside units or panels if the protrusion to the front of the adjoining article is greater than 3 cm (hinge side).  
 Doors with wide angle hinges protrude over the carcass side.

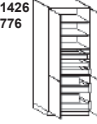


**Larder unit**  
 1 door 142.6 cm with wide angle hinges  
 2 adjustable shelves  
 3 internal drawers  
 1 fixed shelf  
 1 door 77.6 cm with wide angle hinges  
 2 internal pull-outs

78

GGA 30 22 55 02  
 GGA 40 22 55 02  
 GGA 45 22 55 02  
 GGA 50 22 55 02  
 GGA 60 22 55 02

Planning advice:  
 Doors with wide angle hinges may not be planned alongside units or panels if the protrusion to the front of the adjoining article is greater than 3 cm (hinge side).  
 Doors with wide angle hinges protrude over the carcass side.



**Crockery cupboard**  
 2 doors 142.6 cm  
 2 doors 77.6 cm with wide angle hinges  
 2 adjustable shelves  
 3 internal drawers  
 1 fixed shelf,  
 2 internal pull-outs

78

GGA 90 22 55 03

Planning advice:  
 Take account of opening angle

Planning advice:  
 Take account of opening angle

# Tall units 220.8 cm high

Carcase depth 55.5 cm (standard)

- = Models also available in 34/45.5/61 cm carcass depth (Order no.: ... replace ... 55 ... with 34/45/61)
- = Models also available in 45.5/61 cm carcass depth (order no.: replace ... 55 ... with 45/61)
- ▲ = Types also available with 61 cm carcass depth (order no.: ... replace ... 55 ... with 61)

Order no.  
W H D

Hinge side:	Carcass depth	Price groups																						
		1	2	3	4	5	6	7	8	9														
R/L	■	78	GGA 30 22 55 01	1026	1045	1097	1233	1294	1325	1394	1533	-												
				R/L	■	78	GGA 40 22 55 01	1067	1085	1138	1274	1336	1364	1433	1576	-								
								R/L	■	78	GGA 45 22 55 01	1067	1085	1138	1274	1336	1364	1433	1576	-				
												R/L	■	78	GGA 50 22 55 01	1082	1100	1152	1344	1394	1427	1495	1645	-
																R/L	■	78	GGA 60 22 55 01	1143	1165	1224	1470	1530
<b>Planning advice:</b> Doors with wide angle hinges may not be planned alongside units or panels if the protrusion to the front of the adjoining article is greater than 3 cm (hinge side). Doors with wide angle hinges protrude over the carcass side.																								
R/L	■	78	GG 30 22 55 73	731	749	803	955	1015	1045	1113	1224	-												
				R/L	■	78	GG 40 22 55 73	731	749	803	955	1015	1045	1113	1224	-								
								R/L	■	78	GG 45 22 55 73	731	749	803	955	1015	1045	1113	1224	-				
												R/L	■	78	GG 50 22 55 73	731	749	803	1011	1061	1091	1159	1275	-
																R/L	■	78	GG 60 22 55 73	773	793	854	1116	1177
R/L	■	78	GG 30 22 55 12	861	881	933	1085	1145	1177	1244	1368	-												
				R/L	■	78	GG 40 22 55 12	861	881	933	1085	1145	1177	1244	1368	-								
								R/L	■	78	GG 45 22 55 12	861	881	933	1085	1145	1177	1244	1368	-				
												R/L	■	78	GG 50 22 55 12	861	881	933	1141	1190	1222	1290	1419	-
																R/L	■	78	GG 60 22 55 12	904	924	985	1249	1307
■	78	GGA 90 22 55 02	1464	1513	1698	1948	2030	2137	2344	2578	-													
			■	78	GGA 100 22 55 02	1464	1513	1698	1948	2030	2137	2344	2578	-										
R/L	■	84,5	GG 30 22 55 05	385	407	460	610	669	701	769	846	-												
				R/L	■	84,5	GG 40 22 55 05	385	407	460	610	669	701	769	846	-								
								R/L	■	84,5	GG 45 22 55 05	385	407	460	610	669	701	769	846	-				
												R/L	■	84,5	GG 50 22 55 05	385	407	460	665	716	746	814	895	-
																R/L	■	84,5	GG 60 22 55 05	427	447	508	772	831
<b>Width 30, 40, 45, 50, 60 Not available for: MIAMI, VIVA</b>																								
R/L	■	84,5	GGA 30 22 55 081	768	780	839	986	1050	1077	1146	1261	-												
				R/L	■	84,5	GGA 40 22 55 081	768	780	839	986	1050	1077	1146	1261	-								
								R/L	■	84,5	GGA 45 22 55 081	768	780	839	986	1050	1077	1146	1261	-				
												R/L	■	84,5	GGA 50 22 55 081	768	780	839	1046	1093	1128	1194	1313	-
																R/L	■	84,5	GGA 60 22 55 081	807	829	888	1148	1211
<b>Width 30, 40, 45, 50, 60 Not available for: MIAMI, VIVA</b> <b>Planning advice:</b> Doors with wide angle hinges may not be planned alongside units or panels if the protrusion to the front of the adjoining article is greater than 3 cm (hinge side). Doors with wide angle hinges protrude over the carcass side.																								
R/L	■	84,5	GGA 30 22 55 06	1026	1045	1097	1233	1294	1325	1394	1533	-												
				R/L	■	84,5	GGA 40 22 55 06	1067	1085	1138	1274	1336	1364	1433	1576	-								
								R/L	■	84,5	GGA 45 22 55 06	1067	1085	1138	1274	1336	1364	1433	1576	-				
												R/L	■	84,5	GGA 50 22 55 06	1082	1100	1152	1344	1394	1427	1495	1645	-
																R/L	■	84,5	GGA 60 22 55 06	1143	1165	1224	1470	1530
<b>Width 30, 40, 45, 50, 60 Not available for: MIAMI, VIVA</b> <b>Planning advice:</b> Doors with wide angle hinges may not be planned alongside units or panels if the protrusion to the front of the adjoining article is greater than 3 cm (hinge side). Doors with wide angle hinges protrude over the carcass side.																								
R/L	■	78	GG 30 22 55 011	385	407	460	610	669	701	769	846	-												
				R/L	■	78	GG 40 22 55 011	385	407	460	610	669	701	769	846	-								
								R/L	■	78	GG 45 22 55 011	385	407	460	610	669	701	769	846	-				
												R/L	■	78	GG 50 22 55 011	385	407	460	665	716	746	814	895	-
																R/L	■	78	GG 60 22 55 011	427	447	508	772	831
R/L	■	78	GG 30 22 55 012	385	407	460	610	669	701	769	846	-												
				R/L	■	78	GG 40 22 55 012	385	407	460	610	669	701	769	846	-								
								R/L	■	78	GG 45 22 55 012	385	407	460	610	669	701	769	846	-				
												R/L	■	78	GG 50 22 55 012	385	407	460	665	716	746	814	895	-
																R/L	■	78	GG 60 22 55 012	427	447	508	772	831

# Tall units 220.8 cm high

Carcase depth 55.5 cm (standard)

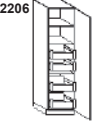
■ = Models also available in 34/45.5/61 cm carcass depth (Order no.: ... replace ... 55 ... with 34/45/61)  
 □ = Models also available in 45.5/61 cm carcass depth (order no.: replace ... 55 ... with 45/61)  
 ▲ = Types also available with 61 cm carcass depth (order no. ... replace ... 55 ... with 61)

Order no.  
W H D

Hinge side:	Carcass depth	Price groups									
		1	2	3	4	5	6	7	8	9	
R/L ■	■	<b>GG 30 22 55 70</b>	467	487	540	691	750	782	850	935	-
		<b>GG 40 22 55 70</b>	467	487	540	691	750	782	850	935	-
		<b>GG 45 22 55 70</b>	467	487	540	691	750	782	850	935	-
		<b>GG 50 22 55 70</b>	467	487	540	746	796	828	897	987	-
		<b>GG 60 22 55 70</b>	508	531	589	853	912	950	1029	1132	-
<b>Width 30, 40, 45, 50, 60 Not available for:</b> ALUELEMENTS, ATLANTA-B, ATLANTA-S, BERGEN, CASTELLO, CHALET-B, CHALET-S, CHICAGO, FRAME, GARDA, LUGANO, LUX-B, MIAMI, MODENA, MUNICH, NEVADA, NOBEL-B, NOBEL-S, ORLANDO-B, ORLANDO-S, OSLO 15, PADUA, SOFIE-B, SOFIE-S, TESSIN 15, TIM 15, TREND, VINO, VIVA, YORK-B, YORK-S Each front has a tightening fitting Ranges without fitting: SMARTGLAS, NOBEL, SOFIE, YORK, LUGANO, TALEA, RIVA, GARDA, ATLANTA, ORLANDO, CHICAGO without tightening fitting											
R/L ■	■	<b>GGA 30 22 55 71</b>	1108	1128	1179	1315	1378	1406	1474	1621	-
		<b>GGA 40 22 55 71</b>	1108	1128	1179	1315	1378	1406	1474	1621	-
		<b>GGA 45 22 55 71</b>	1148	1167	1220	1355	1415	1445	1513	1664	-
		<b>GGA 50 22 55 71</b>	1163	1182	1233	1427	1474	1506	1574	1731	-
		<b>GGA 60 22 55 71</b>	1224	1247	1306	1552	1612	1647	1730	1903	-
<b>Width 30, 40, 45, 50, 60 Not available for:</b> ALUELEMENTS, ATLANTA-B, ATLANTA-S, BERGEN, CASTELLO, CHALET-B, CHALET-S, CHICAGO, FRAME, GARDA, LUGANO, LUX-B, MIAMI, MODENA, MUNICH, NEVADA, NOBEL-B, NOBEL-S, ORLANDO-B, ORLANDO-S, OSLO 15, PADUA, SOFIE-B, SOFIE-S, TESSIN 15, TIM 15, TREND, VINO, VIVA, YORK-B, YORK-S Each front has a tightening fitting Ranges without fitting: SMARTGLAS, NOBEL, SOFIE, YORK, LUGANO, TALEA, RIVA, GARDA, ATLANTA, ORLANDO, CHICAGO without tightening fitting Planning advice: Doors with wide angle hinges may not be planned alongside units or panels if the protrusion to the front of the adjoining article is greater than 3 cm (hinge side). Doors with wide angle hinges protrude over the carcass side.											
R/L ■	■	<b>GGA 30 22 55 72</b>	1115	1135	1188	1324	1385	1415	1484	1632	-
		<b>GGA 40 22 55 72</b>	1115	1135	1188	1324	1385	1415	1484	1632	-
		<b>GGA 45 22 55 72</b>	1154	1174	1226	1361	1423	1454	1521	1673	-
		<b>GGA 50 22 55 72</b>	1171	1189	1242	1433	1482	1513	1580	1738	-
		<b>GGA 60 22 55 72</b>	1232	1255	1315	1559	1621	1659	1738	1912	-
<b>Width 30, 40, 45, 50, 60 Not available for:</b> ALUELEMENTS, ATLANTA-B, ATLANTA-S, BERGEN, CASTELLO, CHALET-B, CHALET-S, CHICAGO, FRAME, GARDA, LUGANO, LUX-B, MIAMI, MODENA, MUNICH, NEVADA, NOBEL-B, NOBEL-S, ORLANDO-B, ORLANDO-S, OSLO 15, PADUA, SOFIE-B, SOFIE-S, TESSIN 15, TIM 15, TREND, VINO, VIVA, YORK-B, YORK-S Each front has a tightening fitting Ranges without fitting: SMARTGLAS, NOBEL, SOFIE, YORK, LUGANO, TALEA, RIVA, GARDA, ATLANTA, ORLANDO, CHICAGO without tightening fitting Planning advice: Doors with wide angle hinges may not be planned alongside units or panels if the protrusion to the front of the adjoining article is greater than 3 cm (hinge side). Doors with wide angle hinges protrude over the carcass side.											
R/L □	□	<b>GB 30 22 55 02</b>	412	424	483	630	694	721	790	869	-
		<b>GB 40 22 55 02</b>	412	424	483	630	694	721	790	869	-
		<b>GB 45 22 55 02</b>	412	424	483	630	694	721	790	869	-
		<b>GB 50 22 55 02</b>	412	424	483	690	737	772	838	922	-
		<b>GB 60 22 55 02</b>	451	473	532	792	855	893	971	1068	-
R/L □	□	<b>GB 30 22 55 01</b>	385	407	460	610	669	701	769	846	-
		<b>GB 40 22 55 01</b>	385	407	460	610	669	701	769	846	-
		<b>GB 45 22 55 01</b>	385	407	460	610	669	701	769	846	-
		<b>GB 50 22 55 01</b>	385	407	460	665	716	746	814	895	-
		<b>GB 60 22 55 01</b>	427	447	508	772	831	867	949	1044	-
R/L □	□	<b>GB 30 22 55 04</b>	412	424	483	630	694	721	790	869	-
		<b>GB 40 22 55 04</b>	412	424	483	630	694	721	790	869	-
		<b>GB 45 22 55 04</b>	412	424	483	630	694	721	790	869	-
		<b>GB 50 22 55 04</b>	412	424	483	690	737	772	838	922	-
		<b>GB 60 22 55 04</b>	451	473	532	792	855	893	971	1068	-
R/L □	□	<b>GB 30 22 55 70</b>	467	487	540	691	750	782	850	935	-
		<b>GB 40 22 55 70</b>	467	487	540	691	750	782	850	935	-
		<b>GB 45 22 55 70</b>	467	487	540	691	750	782	850	935	-
		<b>GB 50 22 55 70</b>	467	487	540	746	796	828	897	987	-
		<b>GB 60 22 55 70</b>	508	531	589	853	912	950	1029	1132	-
<b>Width 30, 40, 45, 50, 60 Not available for:</b> ALUELEMENTS, ATLANTA-B, ATLANTA-S, BERGEN, CASTELLO, CHALET-B, CHALET-S, CHICAGO, FRAME, GARDA, LUGANO, LUX-B, MIAMI, MODENA, MUNICH, NEVADA, NOBEL-B, NOBEL-S, ORLANDO-B, ORLANDO-S, OSLO 15, PADUA, SOFIE-B, SOFIE-S, TESSIN 15, TIM 15, TREND, VINO, VIVA, YORK-B, YORK-S Each front has a tightening fitting Ranges without fitting: SMARTGLAS, NOBEL, SOFIE, YORK, LUGANO, TALEA, RIVA, GARDA, ATLANTA, ORLANDO, CHICAGO without tightening fitting											

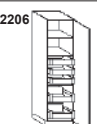


**Crockery cupboard**  
 1 door 220.6 cm  
 1 fixed shelf  
 6 adjustable shelves



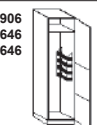
**Larder unit**  
 1 door 220.6 cm with wide angle hinges  
 2 adjustable shelves  
 2 internal pull-outs  
 1 fixed shelf  
 2 internal pull-outs

**Planning advice:**  
 Take account of opening angle

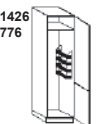


**Larder unit**  
 1 door 220.6 cm with wide angle hinges  
 2 adjustable shelves  
 3 internal drawers  
 1 fixed shelf  
 2 internal pull-outs

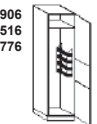
**Planning advice:**  
 Take account of opening angle



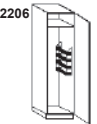
**Broom cupboard**  
 1 door 90.6 cm with 1 door 64.6 cm connected to 1 door 64.6 cm  
 1 fixed shelf  
 1 storage basket  
 1 hook rail



**Broom cupboard**  
 1 door 142.6 cm connected to 1 door 77.6 cm  
 1 fixed shelf  
 1 storage basket  
 1 hook rail



**Broom cupboard**  
 1 door 90.6 cm with 1 door 51.6 cm connected to 1 door 77.6 cm  
 1 fixed shelf  
 1 storage basket  
 1 hook rail



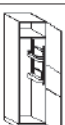



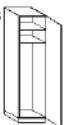

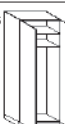



**Broom cupboard**  
 1 door 220.6 cm  
 1 fixed shelf  
 1 hook rail  
 1 storage basket

# Tall units 220.8 cm high

Carcase depth 55.5 cm (standard)

- = Models also available in 34/45.5/61 cm carcass depth (Order no.: ... replace ... 55 ... with 34/45/61)
- = Models also available in 45.5/61 cm carcass depth (order no.: replace ... 55 ... with 45/61)
- ▲ = Types also available with 61 cm carcass depth (order no.: ... replace ... 55 ... with 61)

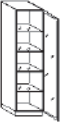
						Price groups											
		Order no.		Hinge side:	Carcass depth	1	2	3	4	5	6	7	8	9			
		W	H	D													
906 646 646 	<b>Broom cupboard</b> 1 door 90.6 cm with 1 door 64.6 cm connected to 1 door 64.6 cm 1 fixed shelf 1 hook rail with 5 hooks, anthracite Modular interior partitioning system, consisting of: 1 set of attachment rails, anthracite 1 large 3-side tray with rail, anthracite 1 carrier box for cleaning materials with carrier rails, anthracite 1 hook rail with 5 hooks, anthracite																
		GB	40	22	55	12	R/L ▲	599	611	670	816	881	907	976	1074	-	
		GB	45	22	55	12	R/L ▲	599	611	670	816	881	907	976	1074	-	
		GB	50	22	55	12	R/L ▲	599	611	670	877	923	958	1025	1128	-	
		GB	60	22	55	12	R/L ▲	638	660	719	978	1042	1079	1158	1274	-	
						Optional accessories HW HS Holder for vacuum cleaner hose or PET storage pocket (for screwing on), anthracite HW UTB Utensils box, e.g. for storing towels, cleaning cloths, etc. (for screwing on), anthracite											
1426 776 	<b>Broom cupboard</b> 1 door 142.6 cm connected to 1 door 77.6 cm 1 fixed shelf 1 hook rail with 5 hooks, anthracite Modular interior partitioning system, consisting of: 1 set of attachment rails, anthracite 1 large 3-side tray with rail, anthracite 1 carrier box for cleaning materials with carrier rails, anthracite 1 hook rail with 5 hooks, anthracite	78															
		GB	40	22	55	11	R/L ▲	571	594	647	796	855	887	955	1051	-	
		GB	45	22	55	11	R/L ▲	571	594	647	796	855	887	955	1051	-	
		GB	50	22	55	11	R/L ▲	571	594	647	851	902	933	1001	1101	-	
		GB	60	22	55	11	R/L ▲	615	634	694	958	1018	1055	1135	1249	-	
						Optional accessories HW HS Holder for vacuum cleaner hose or PET storage pocket (for screwing on), anthracite HW UTB Utensils box, e.g. for storing towels, cleaning cloths, etc. (for screwing on), anthracite											
906 516 776 	<b>Broom cupboard</b> 1 door 90.6 cm with 1 door 51.6 cm connected to 1 door 77.6 cm 1 fixed shelf 1 hook rail with 5 hooks, anthracite Modular interior partitioning system, consisting of: 1 set of attachment rails, anthracite 1 large 3-side tray with rail, anthracite 1 carrier box for cleaning materials with carrier rails, anthracite 1 hook rail with 5 hooks, anthracite	78															
		GB	40	22	55	14	R/L □	599	611	670	816	881	907	976	1074	-	
		GB	45	22	55	14	R/L □	599	611	670	816	881	907	976	1074	-	
		GB	50	22	55	14	R/L □	599	611	670	877	923	958	1025	1128	-	
		GB	60	22	55	14	R/L □	638	660	719	978	1042	1079	1158	1274	-	
						Optional accessories HW HS Holder for vacuum cleaner hose or PET storage pocket (for screwing on), anthracite HW UTB Utensils box, e.g. for storing towels, cleaning cloths, etc. (for screwing on), anthracite											
776 1426 	<b>Broom cupboard</b> 1 door 77.6 cm connected to 1 door 142.6 cm 1 fixed shelf 1 hook rail with 5 hooks, anthracite Modular interior partitioning system, consisting of: 1 set of attachment rails, anthracite 1 large 3-side tray with rail, anthracite 1 carrier box for cleaning materials with carrier rails, anthracite 1 hook rail with 5 hooks, anthracite																
		GB	40	22	55	011	R/L ▲	571	594	647	796	855	887	955	1051	-	
		GB	45	22	55	011	R/L ▲	571	594	647	796	855	887	955	1051	-	
		GB	50	22	55	011	R/L ▲	571	594	647	851	902	933	1001	1101	-	
		GB	60	22	55	011	R/L ▲	615	634	694	958	1018	1055	1135	1249	-	
						Optional accessories HW HS Holder for vacuum cleaner hose or PET storage pocket (for screwing on), anthracite HW UTB Utensils box, e.g. for storing towels, cleaning cloths, etc. (for screwing on), anthracite											
2206 	<b>Broom cupboard</b> 1 door 220.6 cm 1 fixed shelf 1 hook rail with 5 hooks, anthracite Modular interior partitioning system, consisting of: 1 set of attachment rails, anthracite 1 large 3-side tray with rail, anthracite 1 carrier box for cleaning materials with carrier rails, anthracite 1 hook rail with 5 hooks, anthracite																
		GB	40	22	55	71	R/L ▲	654	673	726	878	938	969	1037	1141	-	
		GB	45	22	55	71	R/L ▲	654	673	726	878	938	969	1037	1141	-	
		GB	50	22	55	71	R/L ▲	654	673	726	933	983	1014	1083	1191	-	
		GB	60	22	55	71	R/L ▲	694	718	777	1040	1098	1136	1217	1339	-	
						Width 40, 45, 50, 60 Not available for: ALUELEMENTS, ATLANTA-B, ATLANTA-S, BERGEN, CASTELLO, CHALET-B, CHALET-S, CHICAGO, FRAME, GARDA, LUGANO, LUX-B, MIAMI, MODENA, MUNICH, NEVADA, NOBEL-B, NOBEL-S, ORLANDO-B, ORLANDO-S, OSLO 15, PADUA, SOFIE-B, SOFIE-S, TESSIN 15, TIM 15, TREND, VINO, VIVA, YORK-B, YORK-S Optional accessories HW HS Holder for vacuum cleaner hose or PET storage pocket (for screwing on), anthracite HW UTB Utensils box, e.g. for storing towels, cleaning cloths, etc. (for screwing on), anthracite Each front has a tightening fitting Ranges without fitting: SMARTGLAS, NOBEL, SOFIE, YORK, LUGANO, TALEA, RIVA, GARDA, ATLANTA, ORLANDO, CHICAGO without tightening fitting											
2206 	<b>Hall cupboard / coat stand</b> 1 door 220.6 cm 1 fixed shelf 1 garment rail at a height of 156 cm plus plinth height 1 adjustable shelf																
		GK	45	22	61	70	R/L	784	809	830	956	1049	1101	1174	1289	-	
		GK	50	22	61	70	R/L	795	819	842	969	1061	1112	1185	1301	-	
		GK	60	22	61	70	R/L	806	831	854	980	1071	1124	1198	1316	-	
								Width 45, 50, 60 Not available for: ALUELEMENTS, ATLANTA-B, ATLANTA-S, BERGEN, CASTELLO, CHALET-B, CHALET-S, CHICAGO, FRAME, GARDA, LUGANO, LUX-B, MIAMI, MODENA, MUNICH, NEVADA, NOBEL-B, NOBEL-S, ORLANDO-B, ORLANDO-S, OSLO 15, PADUA, SOFIE-B, SOFIE-S, TESSIN 15, TIM 15, TREND, VINO, VIVA, YORK-B, YORK-S Each front has a tightening fitting Ranges without fitting: SMARTGLAS, NOBEL, SOFIE, YORK, LUGANO, TALEA, RIVA, GARDA, ATLANTA, ORLANDO, CHICAGO without tightening fitting									
2206 	<b>Hall cupboard / coat stand</b> 2 doors 220.6 cm 1 fixed shelf 1 garment rail at a height of 156 cm plus plinth height 1 adjustable shelf																
		GK	90	22	61	70		1550	1600	1645	1898	2081	2185	2333	2564	-	
		GK	100	22	61	70		1574	1623	1667	1920	2104	2207	2355	2588	-	
								Width 90, 100 Not available for: ALUELEMENTS, ATLANTA-B, ATLANTA-S, BERGEN, CASTELLO, CHALET-B, CHALET-S, CHICAGO, FRAME, GARDA, LUGANO, LUX-B, MIAMI, MODENA, MUNICH, NEVADA, NOBEL-B, NOBEL-S, ORLANDO-B, ORLANDO-S, OSLO 15, PADUA, SOFIE-B, SOFIE-S, TESSIN 15, TIM 15, TREND, VINO, VIVA, YORK-B, YORK-S Each front has a tightening fitting Ranges without fitting: SMARTGLAS, NOBEL, SOFIE, YORK, LUGANO, TALEA, RIVA, GARDA, ATLANTA, ORLANDO, CHICAGO without tightening fitting									



## Tall units 220.8 cm high with glass fronts

Carcase depth 55.5 cm (standard)

■ = Models also available in 34/45.5/61 cm carcase depth (Order no.: ... replace ... 55 ... with 34/45/61)




2206 	Crockery cupboard with glass front -neutral- 1 glass door 220.6 cm 4 adjustable glass shelves and 1 additional adjustable glass shelf for individual positioning	34,0 45,5 55,5 61,0	Order no.			Hinge side: R/L	Carcase depth	Glass groups						
			W	H	D			G1	G2	G2S	G5S	G6		
			GGGD 45	22	55	70	R/L	■	-	-	1135	1328	1519	
			GGGD 50	22	55	70	R/L	■	-	-	1160	1358	1544	
			GGGD 60	22	55	70	R/L	■	-	-	1184	1385	1568	
G 1		G 2					G 2S							
G1 AKTIVglass frame 991 Matt glass 992 Translucent black glass	G2 Design front 925 Frame White Agate/Matt glass 935 Premium W. Frame/Matt Glass 940 Macaron Col. Frame/Matt Glass 95 Light grey frame/matt glass 96 Silver Col. Frame/Matt Glass 960 Snow White Frame/Matt Glass 97 Black frame/black glass	G2S aluminium, framed glass door 988 aluminium black, Linea glass 994 Aluminium frame/clear glass 995 aluminium frame/black glass												
G 5		G 5S					G 6							
G5 aluminium, door with mullion 996 Alum.frame/clear gl./cross bar		G6 NEW SALON 986 aluminium black, black glass 987 aluminium black, clear glass 989 aluminium matt, bronze-coloured black glass 990 aluminium matt, bronze-coloured clear glass												

## Additional equipment

	Order no.	W	H	D	Hinge side: R/L	Carcase depth	Decor groups								
							M10	M20	M30	M40	M50	M60	M70	M80	M90
Surcharge for tall cabinets with glass fronts inside and exterior in the same design available in decor groups: S/B/H/MP/F/Z	IDF-G						-	-	-	-	1646	-	1646	1646	-
M 10	M 20	M 30	M 40	M 50											
K M10 laminate				B M50 Velvet lacquer S M50 microstructure lacquer											
M 60	M 70	M 80	M 90												
F M70 veneer / oak / walnut Z M70 Veneer / Bavaria		H M80 high gloss-Lacquer MP M80 laqué mat Premium													

## Tall units 220.8 cm high with roller shutter

The useable inside depth (bare dimension) for the following carcase depths is  
36.1 cm – bare dimension 26.5 cm / 47.7 cm – bare dimension 38.1 cm 57.7 cm – bare dimension 48.1 cm / 63.2 cm – bare dimension 53.6 cm ▲ = Types also available with 63.2 cm carcase depth (order no. ... replace ... 58 ... with 63)

	Tall unit with roller shutter 220,8 cm high Roller shutter stainless steel decor 6 adjustable shelves 1 structural shelf 3 sockets	GJG 60 22 58 77	▲	1801	-	-	-	4242	-	5024	-	-
	as above, but Tall unit with roller shutter 220,8 cm high 47,7 cm deep	GJG 60 22 48 77		1757	-	-	-	3921	-	4597	-	-
	Tall unit with roller shutter 220,8 cm high Roller shutters black laminate 6 adjustable shelves 1 structural shelf 3 sockets	GJG 60 22 58 78	▲	1930	-	-	-	4370	-	5153	-	-
	as above, but Tall unit with roller shutter 220,8 cm high 47,7 cm deep	GJG 60 22 48 78		1886	-	-	-	4049	-	4725	-	-
	Tall unit SMARTGLAS roller shutters 220,8 cm high 57,7 cm deep 6 adjustable shelves 1 structural shelf 3 sockets	GJSGG60 22 58	▲	3670	-	-	-	6110	-	6892	-	-
	as above, but Tall unit SMARTGLAS roller shutters 220,8 cm high 47,7 cm deep	GJSGG60 22 48		3625	-	-	-	5789	-	6465	-	-
M 10	M 20	M 30	M 40	M 50								
K M10 laminate				B M50 Velvet Lacquer S Microstructur lacquer								
M 60	M 70	M 80	M 90									
F M70 veneer / oak / walnut Z M70 Veneer / Bavaria												

# Tall units 220.8 cm high with roller shutter

The useable inside depth (bare dimension) for the following carcass depths is  
 36.1 cm – bare dimension 26.5 cm / 47.7 cm – bare dimension 38.1 cm  
 57.7 cm – bare dimension 48.1 cm / 63.2 cm – bare dimension 53.6 cm  
 ▲ = Types also available with 63.2 cm carcass depth (order no. ... replace ... 58 ... with 63)

Order no.  
W H D

Hinge side:	Carcass depth	Decor groups								
		M10	M20	M30	M40	M50	M60	M70	M80	M90



### Pull-out shelf with guide rails

With locking function, full pull-out „push to open“, shelf from decor group K  
 For carcass width 45 cm, 50 cm, 60 cm  
 For carcass width 80 cm, 90 cm  
 for carcass depths 45.5 cm and 55.5 cm

- Load-bearing capacity depth 55.5 cm: 35 kg
- Load-bearing capacity depth 45.5 cm: 35 kg
- Load-bearing capacity depth 55.5 cm: 35 kg
- Load-bearing capacity depth 45.5 cm: 35 kg
- Load-bearing capacity depth 55.5 cm: 35 kg
- Load-bearing capacity depth 45.5 cm: 35 kg
- Load-bearing capacity depth 55.5 cm: 30 kg
- Load-bearing capacity depth 45.5 cm: 30 kg
- Load-bearing capacity depth 55.5 cm: 30 kg
- Load-bearing capacity depth 45.5 cm: 30 kg



**Important:**  
 When installing in units with hinged doors always take wide angle hinges SA-90155E3 into consideration.

TAB-AZ45 55	220	-	-	-	-	-	-	-	-	-
TAB-AZ45 45	220	-	-	-	-	-	-	-	-	-
TAB-AZ50 55	225	-	-	-	-	-	-	-	-	-
TAB-AZ50 45	225	-	-	-	-	-	-	-	-	-
TAB-AZ60 55	234	-	-	-	-	-	-	-	-	-
TAB-AZ60 45	234	-	-	-	-	-	-	-	-	-
TAB-AZ80 55	282	-	-	-	-	-	-	-	-	-
TAB-AZ80 45	282	-	-	-	-	-	-	-	-	-
TAB-AZ90 55	298	-	-	-	-	-	-	-	-	-
TAB-AZ90 45	298	-	-	-	-	-	-	-	-	-

## Appliance unit 220.8 cm high for microwave / oven

Carcass depth 55.5 cm (standard)

▲ = Types also available with 61 cm carcass depth (order no. ... replace ... 55 ... with 61)

Order no.  
W H D

Hinge side:	Carcass depth	Price groups								
		1	2	3	4	5	6	7	8	9

906 776

**Appliance unit**  
 1 door 90.6 cm  
 3 adjustable shelves  
 1 panel  
 1 appliance aperture 36.2 - 50 cm  
 1 door 77.6 cm  
 2 adjustable shelves

36.2-50.0  
78

GO 60 22 55 10 1	R/L ▲	464	484	538	629	666	700	761	837	-
GO 60 22 55 10 1A	R/L ▲	464	484	538	629	666	700	761	837	-

906 776

**Appliance unit**  
 1 door 90.6 cm  
 3 adjustable shelves  
 1 panel  
 1 appliance aperture 36.2 - 50 cm  
 1 door 77.6 cm with wide angle hinges  
 3 internal drawers

36.2-50.0  
78

**Planning advice:**  
 Take account of opening angle

**Appliance unit with compensation door above appliance aperture**

GO 60 22 55 10 4	R/L ▲	847	866	921	1011	1047	1082	1143	1257	-
GO 60 22 55 10 4A	R/L ▲	847	866	921	1011	1047	1082	1143	1257	-

906 126 256 386

**Appliance unit**  
 1 door 90.6 cm  
 3 adjustable shelves  
 1 panel  
 1 appliance aperture 36.2 - 50 cm  
 1 drawer 12.6 cm  
 1 pull-out 25.6 cm  
 1 pull-out 38.6 cm

36.2-50.0  
78

**Appliance unit with compensation door above appliance aperture**

GO 60 22 55 10 2	R/L ▲	939	961	1014	1105	1142	1176	1235	1359	-
GO 60 22 55 10 2A	R/L ▲	939	961	1014	1105	1142	1176	1235	1359	-

906 386 386

**Appliance unit**  
 1 door 90.6 cm  
 3 adjustable shelves  
 1 panel  
 1 appliance aperture 36.2 - 50 cm  
 2 pull-outs 38.6 cm

36.2-50.0  
78

**Appliance unit with compensation door above appliance aperture**

GO 60 22 55 10 X4	R/L ▲	852	875	928	1018	1055	1089	1148	1263	-
GO 60 22 55 10 X4A	R/L ▲	852	875	928	1018	1055	1089	1148	1263	-

841

**Appliance unit with compensation door above appliance aperture**  
 1 appliance aperture 36.2 - 50 cm  
 1 door 84.1 cm  
 5 adjustable shelves

36.2-50.0  
84,5  
NEW

GO 60 22 55 10 8A	R/L ▲	464	484	538	629	666	700	761	837	-
-------------------	-------	-----	-----	-----	-----	-----	-----	-----	-----	---

386 451





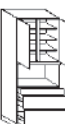



**Appliance unit**  
 1 appliance aperture 37.3 - 50 cm  
 1 pull-out 38.6 cm  
 1 pull-out 45.1 cm  
 3 adjustable shelves

37,3-50,0  
84,5

GO 60 22 55 10 X9A	R/L ▲	794	815	869	962	997	1031	1091	1200	-
--------------------	-------	-----	-----	-----	-----	-----	------	------	------	---

# Appliance unit 220.8 cm high for microwave / oven

Carcase depth 55.5 cm (standard)

















		Order no.				Hinge side:	Carcase depth	Price groups												
		W	H	D				1	2	3	4	5	6	7	8	9				
776 906		<b>Appliance unit</b>	37,3-50,0	GO	60	22	55	10	R/L	▲	464	484	538	629	666	700	761	837	-	
		1 door 77.6 cm 1 panel 1 appliance aperture 37.3 - 50 cm 1 door 90.6 cm 5 adjustable shelves																		
		<b>Appliance unit with compensation door above appliance aperture</b>		GO	60	22	55	10	A	R/L	▲	464	484	538	629	666	700	761	837	-
776 126 776		<b>Appliance unit</b>	37,3-50,0 78	GO	60	22	55	10	5	R/L	▲	607	628	684	773	810	844	904	994	-
		1 door 77.6 cm 1 panel 1 appliance aperture 37.3 - 50 cm 1 drawer 12.6 cm 1 door 77.6 cm 4 adjustable shelves																		
		<b>Appliance unit with compensation door above appliance aperture</b>		GO	60	22	55	10	5A	R/L	▲	607	628	684	773	810	844	904	994	-
776 126 386 386		<b>Appliance unit</b>	37,3-50,0 78	GO	60	22	55	10	3	R/L	▲	939	961	1014	1106	1142	1176	1235	1359	-
		1 door 77.6 cm 2 adjustable shelves 1 panel 1 appliance aperture 37.3 - 50 cm 1 drawer 12.6 cm 2 pull-outs 38.6 cm																		
		<b>Appliance unit with compensation door above appliance aperture</b>		GO	60	22	55	10	3A	R/L	▲	939	961	1014	1106	1142	1176	1235	1359	-
906 776		<b>Appliance unit</b>	46,0-48,0 78	GO	90	22	55	10			▲	813	847	943	1102	1168	1224	1332	1465	-
		2 doors 90.6 cm 3 adjustable shelves 1 panel 1 appliance aperture 46.0 - 48.0 cm 2 doors 77.6 cm 2 adjustable shelves																		
		<b>Appliance unit with compensation door above appliance aperture</b>		GO	90	22	55	10	A		▲	813	847	943	1102	1168	1224	1332	1465	-
906 126 256 386		<b>Appliance unit</b>	46,0-48,0 78	GO	90	22	55	10	12		▲	1423	1470	1654	1905	1986	2096	2303	2533	-
		2 doors 90.6 cm 3 adjustable shelves 1 panel 1 appliance aperture 46.0 - 48.0 cm 1 drawer 12.6 cm 1 pull-out 25.6 cm 1 pull-out 38.6 cm																		
		<b>Appliance unit with compensation door above appliance aperture</b>		GO	90	22	55	10	12A		▲	1423	1470	1654	1905	1986	2096	2303	2533	-
841 711		<b>Appliance unit</b>	58,0-59,5 71,5	GO	60	22	55	20	9	R/L	▲	464	484	538	629	666	700	761	837	-
		1 door 84.1 cm 1 panel 1 appliance aperture 58.0 - 59.5 cm 1 door 71.1 cm 4 adjustable shelves																		
		<b>Appliance unit with compensation door above appliance aperture</b>	NEW	GO	60	22	55	20	9A	R/L	▲	464	484	538	629	666	700	761	837	-
776 776		<b>Appliance unit</b>	58,0-59,5 78	GO	60	22	55	20	X	R/L	▲	464	484	538	629	666	700	761	837	-
		1 door 77.6 cm 1 panel 1 appliance aperture 58.0 - 59.5 cm 1 door 77.6 cm 4 adjustable shelves																		
		<b>Appliance unit with compensation door above appliance aperture</b>		GO	60	22	55	20	XA	R/L	▲	464	484	538	629	666	700	761	837	-
776 776		<b>Appliance unit</b>	58,0-59,5 78	GO	60	22	55	20	X10	R/L	▲	820	840	894	985	1022	1056	1117	1229	-
		1 door 77.6 cm 2 adjustable shelves 1 panel 1 appliance aperture 58.0 - 59.5 cm 1 door 77.6 cm 2 internal pull-outs																		
		<b>Appliance unit with compensation door above appliance aperture</b>	NEW	GO	60	22	55	20	X10A	R/L	▲	820	840	894	985	1022	1056	1117	1229	-





# Appliance unit 220.8 cm high for microwave / oven

Carcase depth 55.5 cm (standard)




Order no.	W	H	D	Hinge side:	Carcase depth	Price groups								
						1	2	3	4	5	6	7	8	9
776 776 	<b>Appliance unit</b> 1 door 77.6 cm 2 adjustable shelves 1 panel 1 appliance aperture 58.0 - 59.5 cm 1 door 77.6 cm 1 internal drawer 2 internal pull-outs	58,0-59,5  <b>NEW</b>	<b>GO 60 22 55 20 X11</b>	R/L ▲	▲	938	958	1012	1103	1140	1174	1235	1359	-
						<b>Appliance unit with compensation door above appliance aperture</b>								
776 776 	<b>Appliance unit</b> 1 door 77.6 cm 2 adjustable shelves 1 panel 1 appliance aperture 58.0 - 59.5 cm 1 door 77.6 cm with wide angle hinges 3 internal drawers	58,0-59,5  <b>NEW</b>	<b>GO 60 22 55 20 X7</b>	R/L ▲	▲	847	866	921	1011	1047	1082	1143	1257	-
						<b>Appliance unit with compensation door above appliance aperture</b>								
776 126 646 	<b>Appliance unit</b> 1 door 77.6 cm 1 panel 1 appliance aperture 58.0 - 59.5 cm 1 drawer 12.6 cm 1 door 64.6 cm 4 adjustable shelves	58,0-59,5  <b>NEW</b>	<b>GO 60 22 55 20 X5</b>	R/L ▲	▲	551	571	625	716	754	787	848	933	-
						<b>Appliance unit with compensation door above appliance aperture</b>								
776 386 386 	<b>Appliance unit</b> 1 door 77.6 cm 2 adjustable shelves 1 panel 1 appliance aperture 58.0 - 59.5 cm 2 pull-outs 38.6 cm	58,0-59,5  <b>NEW</b>	<b>GO 60 22 55 20 X4</b>	R/L ▲	▲	794	815	869	962	997	1031	1091	1200	-
						<b>Appliance unit with compensation door above appliance aperture</b>								
776 256 256 256 	<b>Appliance unit</b> 1 door 77.6 cm 1 panel 1 appliance aperture 58.0 - 59.5 cm 3 pull-outs 25.6 cm 2 adjustable shelves	58,0-59,5  <b>NEW</b>	<b>GO 60 22 55 20 X6</b>	R/L ▲	▲	983	1003	1060	1137	1174	1208	1270	1397	-
						<b>Appliance unit with compensation door above appliance aperture</b>								
776 126 256 386 	<b>Appliance unit</b> 1 door 77.6 cm 1 panel 1 appliance aperture 58.0 - 59.5 cm 1 drawer 12.6 cm 1 pull-out 25.6 cm 1 pull-out 38.6 cm 2 adjustable shelves	58,0-59,5  <b>NEW</b>	<b>GO 60 22 55 20 X3</b>	R/L ▲	▲	940	958	1015	1094	1131	1165	1225	1348	-
						<b>Appliance unit with compensation door above appliance aperture</b>								
711 841 	<b>Appliance unit</b> 1 door 71.1 cm 1 panel 1 appliance aperture 58.0 - 59.5 cm 1 door 84.1 cm 4 adjustable shelves	58,0-59,5  <b>NEW</b>	<b>GO 60 22 55 20 8</b>	R/L ▲	▲	464	484	538	629	666	700	761	837	-
						<b>Appliance unit with compensation door above appliance aperture</b>								
711 841 	<b>Appliance unit</b> 1 door 71.1 cm 2 adjustable shelves 1 panel 1 appliance aperture 58.0 - 59.5 cm 1 door 84.1 cm 2 internal pull-outs	58,0-59,5  <b>NEW</b>	<b>GO 60 22 55 20 X12</b>	R/L ▲	▲	820	840	894	985	1022	1056	1117	1193	-
						<b>Appliance unit with compensation door above appliance aperture</b>								



Models not available with compensation door: MIAMI, VIVA

# Appliance unit 220.8 cm high for microwave / oven






Carcase depth 55.5 cm (standard)

		Order no.			Hinge side:	Carcase depth	Price groups								
		W	H	D			1	2	3	4	5	6	7	8	9
711 841		<b>Appliance unit</b> 1 door 71.1 cm 2 adjustable shelves 1 panel 1 appliance aperture 58.0 - 59.5 cm 1 door 84.1 cm 1 internal drawer 2 internal pull-outs	58,0-59,5	GO 60 22 55 20 X13	R/L	▲	938	958	1012	1103	1140	1174	1235	1311	-
		<b>Appliance unit with compensation door above appliance aperture</b>	58,0-59,5	GO 60 22 55 20 X13A	R/L	▲	938	958	1012	1103	1140	1174	1235	1311	-
711 126 256 451		<b>Appliance unit</b> 1 door 71.1 cm 1 panel 1 appliance aperture 58.0 - 59.5 cm 1 drawer 12.6 cm 1 pull-out 25.6 cm 1 pull-out 45.1 cm 2 adjustable shelves	58,0-59,5	GO 60 22 55 20 X8	R/L	▲	940	958	1015	1094	1131	1165	1225	1348	-
		<b>Appliance unit with compensation door above appliance aperture</b>	58,0-59,5	GO 60 22 55 20 X8A	R/L	▲	940	958	1015	1094	1131	1165	1225	1348	-
386 451		<b>Appliance unit</b> 1 appliance aperture 58.0 - 59.5 cm 1 pull-out 38.6 cm 1 pull-out 45.1 cm 2 adjustable shelves	58,0-59,5	GO 60 22 55 20 X9A	R/L	▲	794	815	869	962	997	1031	1091	1200	-
		<b>Appliance unit with compensation door above appliance aperture</b>	58,0-59,5	GO 60 22 55 20 X9A	R/L	▲	794	815	869	962	997	1031	1091	1200	-

# Appliance unit 220.8 cm high for microwave / oven Double aperture

Carcase depth 55.5 cm (standard)


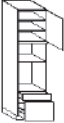
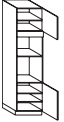





▲ = Types also available with 61 cm carcase depth (order no. ... replace ... 55 ... with 61)

776 386		<b>Appliance unit</b> 1 door 77.6 cm 1 panel 1 appliance aperture 45.0 cm 1 appliance aperture 45.0 cm 1 door 38.6 cm 2 adjustable shelves	45,0	GO 60 22 55 09 A	R/L	▲	491	508	565	655	693	726	787	866	-
		<b>Appliance unit with compensation door above appliance aperture</b>	45,0	GO 60 22 55 09 AA	R/L	▲	491	508	565	655	693	726	787	866	-
516 646		<b>Appliance unit</b> 1 door 51.6 cm 1 panel 1 appliance aperture 45.0 cm 1 appliance aperture 45.0 cm 1 door 64.6 cm 3 adjustable shelves	45,0	GO 60 22 55 09 C	R/L	▲	491	508	565	655	693	726	787	866	-
		<b>Appliance unit with compensation door above appliance aperture</b>	45,0	GO 60 22 55 09 CA	R/L	▲	491	508	565	655	693	726	787	866	-
516 256 386		<b>Appliance unit</b> 1 door 51.6 cm 1 panel 1 appliance aperture 45.0 cm 1 appliance aperture 45.0 cm 1 pull-out 25.6 cm 1 pull-out 38.6 cm 1 adjustable shelf	45,0	GO 60 22 55 09 C2	R/L	▲	797	815	870	955	992	1025	1087	1196	-
		<b>Appliance unit with compensation door above appliance aperture</b>	45,0	GO 60 22 55 09 C2A	R/L	▲	797	815	870	955	992	1025	1087	1196	-
776 386		<b>Appliance unit</b> 1 door 77.6 cm 1 panel 1 appliance aperture 30.8 - 40.9 cm 1 appliance aperture 58.0 - 59.5 cm 1 door 38.6 cm 2 adjustable shelves	30,8-40,9	GO 60 22 55 27 XA	R/L	▲	464	484	538	629	666	700	761	837	-
		<b>Appliance unit with compensation door above appliance aperture</b>	58,0-59,5	GO 60 22 55 27 XAA	R/L	▲	464	484	538	629	666	700	761	837	-
776 386		<b>Appliance unit</b> 1 door 77.6 cm 2 adjustable shelves 1 panel 1 appliance aperture 30.8 - 40.9 cm 1 appliance aperture 58.0 - 59.5 cm 1 pull-out 38.6 cm	30,8-40,9	GO 60 22 55 27 XA2	R/L	▲	612	633	688	778	815	849	908	999	-
		<b>Appliance unit with compensation door above appliance aperture</b>	58,0-59,5	GO 60 22 55 27 XA2A	R/L	▲	612	633	688	778	815	849	908	999	-



Models not available with compensation door: MIAMI, VIVA

**Appliance unit 220.8 cm high for microwave / oven Double aperture**  
 Carcase depth 55.5 cm (standard)

			Price groups																	
			Order no.			Hinge side:	Carcase depth	1	2	3	4	5	6	7	8	9				
			W	H	D															
646 516		<b>Appliance unit</b> 1 door 64.6 cm 1 panel 1 appliance aperture 30.8 - 40.9 cm 1 appliance aperture 58.0 - 59.5 cm 1 door 51.6 cm 3 adjustable shelves	30,8-40,9	GO	60	22	55	27	XB	R/L	▲	464	484	538	629	666	700	761	837	-
		<b>Appliance unit with compensation door above appliance aperture</b>	GO	60	22	55	27	XBA	R/L	▲	464	484	538	629	666	700	761	837	-	
646 126 386		<b>Appliance unit</b> 1 door 64.6 cm 2 adjustable shelves 1 panel 1 appliance aperture 30.8 - 40.9 cm 1 appliance aperture 58.0 - 59.5 cm 1 drawer 12.6 cm 1 pull-out 38.6 cm	30,8-40,9	GO	60	22	55	27	XB3	R/L	▲	759	778	832	923	962	992	1055	1161	-
		<b>Appliance unit with compensation door above appliance aperture</b>	GO	60	22	55	27	XB3A	R/L	▲	759	778	832	923	962	992	1055	1161	-	
516 646		<b>Appliance unit</b> 1 door 51.6 cm 1 panel 1 appliance aperture 30.8 - 40.9 cm 1 appliance aperture 58.0 - 59.5 cm 1 door 64.6 cm 3 adjustable shelves	30,8-40,9	GO	60	22	55	27	XC	R/L	▲	464	484	538	629	666	700	761	837	-
		<b>Appliance unit with compensation door above appliance aperture</b>	GO	60	22	55	27	XCA	R/L	▲	464	484	538	629	666	700	761	837	-	
516 256 386		<b>Appliance unit</b> 1 door 51.6 cm 1 panel 1 appliance aperture 30.8 - 40.9 cm 1 appliance aperture 58.0 - 59.5 cm 1 pull-out 25.6 cm 1 pull-out 38.6 cm 1 adjustable shelf	30,8-40,9	GO	60	22	55	27	XC2	R/L	▲	797	815	870	955	992	1025	1087	1196	-
		<b>Appliance unit with compensation door above appliance aperture</b>	GO	60	22	55	27	XC2A	R/L	▲	797	815	870	955	992	1025	1087	1196	-	
516 256 256		<b>Appliance unit</b> 1 door 51.6 cm 1 panel 1 appliance aperture 37.2 - 50 cm 1 appliance aperture 58.0 - 59.5 cm 2 pull-outs 25.6 cm 1 adjustable shelf	37,2-50,0	GO	60	22	55	28	XB4	R/L	▲	794	815	869	962	997	1031	1091	1200	-
		<b>Appliance unit with compensation door above appliance aperture</b>	GO	60	22	55	28	XB4A	R/L	▲	794	815	869	962	997	1031	1091	1200	-	
646 386		<b>Appliance unit</b> 1 door 64.6 cm 1 panel 1 appliance aperture 41 - 50 cm 1 appliance aperture 58.0 - 59.5 cm 1 door 38.6 cm 2 adjustable shelves	41,0-50,0	GO	60	22	55	28	XA	R/L	▲	464	484	538	629	666	700	761	837	-
		<b>Appliance unit with compensation door above appliance aperture</b>	GO	60	22	55	28	XAA	R/L	▲	464	484	538	629	666	700	761	837	-	
646 386		<b>Appliance unit</b> 1 door 64.6 cm 2 adjustable shelves 1 panel 1 appliance aperture 41 - 50 cm 1 appliance aperture 58.0 - 59.5 cm 1 pull-out 38.6 cm	41,0-50,0	GO	60	22	55	28	XA2	R/L	▲	612	633	688	778	815	849	908	999	-
		<b>Appliance unit with compensation door above appliance aperture</b>	GO	60	22	55	28	XA2A	R/L	▲	612	633	688	778	815	849	908	999	-	
646 451		<b>Appliance unit</b> 1 door 64.6 cm 2 adjustable shelves 1 panel 1 appliance aperture 41 - 50 cm 1 appliance aperture 58.0 - 59.5 cm 1 pull-out 45.1 cm 2 adjustable shelves	41,0-50,0	GO	60	22	55	28	XA4	R/L	▲	612	633	688	778	815	849	908	999	-
		<b>Appliance unit with compensation door above appliance aperture</b>	GO	60	22	55	28	XA4A	R/L	▲	612	633	688	778	815	849	908	999	-	


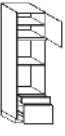
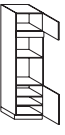
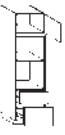
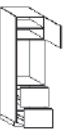

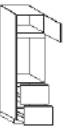



Models not available with compensation door: MIAMI, VIVA

# Appliance unit 220.8 cm high for microwave / oven Double aperture

Carcase depth 55.5 cm (standard)

▲ = Types also available with 61 cm carcass depth (order no. ... replace ... 55 ... with 61)

				Order no.				Price groups								
				W H D		Hinge side:	Carcass depth	1	2	3	4	5	6	7	8	9
516 516		<b>Appliance unit</b> 1 door 51.6 cm 1 panel 1 appliance aperture 41 - 50 cm 1 appliance aperture 58.0 - 59.5 cm 1 door 51.6 cm 2 adjustable shelves	41,0-50,0	<b>GO 60 22 55 28 XB</b>	R/L	▲	464	484	538	629	666	700	761	837	-	
			58,0-59,5													
		<b>Appliance unit with compensation door above appliance aperture</b>		<b>GO 60 22 55 28 XBA</b>	R/L	▲	464	484	538	629	666	700	761	837	-	
516 126 386		<b>Appliance unit</b> 1 door 51.6 cm 1 adjustable shelf 1 panel 1 appliance aperture 41 - 50 cm 1 appliance aperture 58.0 - 59.5 cm 1 drawer 12.6 cm 1 pull-out 38.6 cm	41,0-50,0	<b>GO 60 22 55 28 XB3</b>	R/L	▲	759	778	832	923	962	992	1055	1161	-	
			58,0-59,5													
		<b>Appliance unit with compensation door above appliance aperture</b>		<b>GO 60 22 55 28 XB3A</b>	R/L	▲	759	778	832	923	962	992	1055	1161	-	
386 646		<b>Appliance unit</b> 1 door 38.6 cm 1 panel 1 appliance aperture 41 - 50 cm 1 appliance aperture 58.0 - 59.5 cm 1 door 64.6 cm 2 adjustable shelves	41,0-50,0	<b>GO 60 22 55 28 XC</b>	R/L	▲	464	484	538	629	666	700	761	837	-	
			58,0-59,5													
		<b>Appliance unit with compensation door above appliance aperture</b>		<b>GO 60 22 55 28 XCA</b>	R/L	▲	464	484	538	629	666	700	761	837	-	
386 256 386		<b>Appliance unit</b> 1 door 38.6 cm 1 panel 1 appliance aperture 41 - 50 cm 1 appliance aperture 58.0 - 59.5 cm 1 pull-out 25.6 cm 1 pull-out 38.6 cm	41,0-50,0	<b>GO 60 22 55 28 XC2</b>	R/L	▲	797	815	870	955	992	1025	1087	1196	-	
			58,0-59,5													
		<b>Appliance unit with compensation door above appliance aperture</b>		<b>GO 60 22 55 28 XC2A</b>	R/L	▲	797	815	870	955	992	1025	1087	1196	-	
386 386		<b>Appliance unit with compensation door above appliance aperture</b> 1 compensation door 1 adjustable shelf 1 appliance aperture 80 - 95 cm 2 pull-outs 38.6 cm	80,0-95,0	<b>GO 60 22 55 21 X1A</b>	R/L	▲	794	815	869	962	997	1031	1091	1200	-	
			78													
		<b>optional accessories: Appliance support bracket set including fixing materials</b>		<b>GAW-SET</b>			29.80									
646 126 386		<b>Appliance unit</b> 1 door 64.6 cm 2 adjustable shelves 1 panel 1 appliance aperture 80 - 95 cm 1 drawer 12.6 cm 1 pull-out 38.6 cm	80,0-95,0	<b>GO 60 22 55 24 X</b>	R/L	▲	759	778	832	923	962	992	1055	1161	-	
		<b>Appliance unit with compensation door above appliance aperture</b>		<b>GO 60 22 55 24 XA</b>	R/L	▲	759	778	832	923	962	992	1055	1161	-	
		<b>optional accessories: Appliance support bracket set including fixing materials</b>		<b>GAW-SET</b>			29.80									
386 386 386		<b>Appliance unit</b> 1 door 38.6 cm 1 panel 1 appliance aperture 87 - 95 cm 2 pull-outs 38.6 cm	87,0-95,0	<b>GO 60 22 55 21 X1</b>	R/L	▲	794	815	869	962	997	1031	1091	1200	-	
			78													
		<b>optional accessories: Appliance support bracket set including fixing materials</b>		<b>GAW-SET</b>			29.80									
516 126 386		<b>Appliance unit</b> 1 door 51.6 cm 1 adjustable shelf 1 panel 1 appliance aperture 100-116,8 cm 1 drawer 12.6 cm 1 pull-out 38.6 cm 1 appliance aperture 100-116,8 cm	100-116,8	<b>GO 60 22 55 25 X</b>	R/L	▲	759	778	832	923	962	992	1055	1161	-	
		<b>Appliance unit with compensation door above appliance aperture</b>		<b>GO 60 22 55 25 XA</b>	R/L	▲	759	778	832	923	962	992	1055	1161	-	
				<b>For the following built-in components:</b> Oven, metal base/metal bracket, compact appliance												



# Appliance unit 220.8 cm high for microwave / oven Double aperture

Carcase depth 55.5 cm (standard)

		Order no. W H D		Hinge side:	Carcase depth	Price groups								
						1	2	3	4	5	6	7	8	9
<b>optional accessories:</b> <b>Appliance support bracket set including fixing materials</b>		<b>GAW-SET</b>				29,80								
516 126 386 	<b>Appliance unit</b> 1 door 51.6 cm 1 panel 1 appliance aperture 100-116,8 cm 1 door 51.6 cm 2 adjustable shelves <b>Appliance unit with compensation door above appliance aperture</b>	100-116,8 	<b>GO 60 22 55 32 XB</b>	R/L	▲	464	484	538	629	666	700	761	837	-
	For the following built-in components: Oven, metal base/metal bracket, compact appliance													
<b>optional accessories:</b> <b>Appliance support bracket set including fixing materials</b>		<b>GAW-SET</b>				29,80								

# Appliance unit 220.8 cm high for microwave / oven Lifting door / aperture

Carcase depth 55.5 cm (standard)

▲= Types also available with 61 cm carcage depth(order no. ... replace ... 55 ... with 61)

646 516 386 	<b>Appliance unit</b> 1 door 64.6 cm 1 lifting door with front 51.6 cm 1 panel 1 appliance aperture 58.0 - 59.5 cm 1 pull-out 38.6 cm 2 adjustable shelves <b>Appliance unit with compensation door above appliance aperture</b>	58,0-59,5 	<b>GO 60 22 55 36 X5</b>	R/L	▲	745	765	823	907	946	976	1038	1142	-
	For the following built-in components: Oven, metal base/metal bracket, compact appliance													
<b>optional accessories:</b> <b>Appliance support bracket set including fixing materials</b>		<b>GAW-SET</b>				29,80								
646 516 126 256 	<b>Appliance unit</b> 1 door 64.6 cm 1 lifting door with front 51.6 cm 1 panel 1 appliance aperture 58.0 - 59.5 cm 1 drawer 12.6 cm 1 pull-out 25.6 cm 2 adjustable shelves <b>Appliance unit with compensation door above appliance aperture</b>	58,0-59,5 	<b>GO 60 22 55 36 X6</b>	R/L	▲	893	909	968	1054	1090	1121	1184	1302	-
	For the following built-in components: Oven, metal base/metal bracket, compact appliance													
<b>optional accessories:</b> <b>Appliance support bracket set including fixing materials</b>		<b>GAW-SET</b>				29,80								
646 386 516 	<b>Appliance unit</b> 1 door 64.6 cm 1 lifting door with front 38.6 cm 1 panel 1 appliance aperture 58.0 - 59.5 cm 1 door 51.6 cm 3 adjustable shelves <b>Appliance unit with compensation door above appliance aperture</b>	58,0-59,5 	<b>GO 60 22 55 29 X</b>	R/L	▲	597	616	674	760	796	828	890	979	-
	For the following built-in components: Oven, metal base/metal bracket, compact appliance													
<b>optional accessories:</b> <b>Appliance support bracket set including fixing materials</b>		<b>GAW-SET</b>				29,80								
646 386 126 386 	<b>Appliance unit</b> 1 door 64.6 cm 2 adjustable shelves 1 lifting door with front 38.6 cm 1 panel 1 appliance aperture 58.0 - 59.5 cm 1 drawer 12.6 cm 1 pull-out 38.6 cm <b>Appliance unit with compensation door above appliance aperture</b>	58,0-59,5 	<b>GO 60 22 55 29 X2</b>	R/L	▲	893	909	968	1054	1090	1121	1184	1302	-
	For the following built-in components: Oven, metal base/metal bracket, compact appliance													
<b>optional accessories:</b> <b>Appliance support bracket set including fixing materials</b>		<b>GAW-SET</b>				29,80								
516 516 256 256 	<b>Appliance unit</b> 1 door 51.6 cm 1 lifting door with front 51.6 cm 1 panel 1 appliance aperture 58.0 - 59.5 cm 2 pull-outs 25.6 cm 1 adjustable shelf <b>Appliance unit with compensation door above appliance aperture</b>	58,0-59,5 	<b>GO 60 22 55 36 X2</b>	R/L	▲	928	948	1005	1090	1129	1159	1221	1343	-
	For the following built-in components: Oven, metal base/metal bracket, compact appliance													
<b>optional accessories:</b> <b>Appliance support bracket set including fixing materials</b>		<b>GAW-SET</b>				29,80								
516 516 126 386 	<b>Appliance unit</b> 1 door 51.6 cm 1 lifting door with front 51.6 cm 1 panel 1 appliance aperture 58.0 - 59.5 cm 1 drawer 12.6 cm 1 pull-out 38.6 cm 1 adjustable shelf <b>Appliance unit with compensation door above appliance aperture</b>	58,0-59,5 	<b>GO 60 22 55 36 X4</b>	R/L	▲	893	909	968	1054	1090	1121	1184	1302	-
	For the following built-in components: Oven, metal base/metal bracket, compact appliance													
<b>optional accessories:</b> <b>Appliance support bracket set including fixing materials</b>		<b>GAW-SET</b>				29,80								

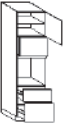





# Appliance unit 220.8 cm high for microwave / oven Lifting door / aperture

Carcase depth 55.5 cm (standard)

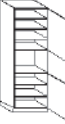
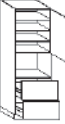
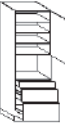



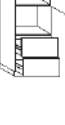

▲ = Types also available with 61 cm carcase depth (order no. ... replace ... 55 ... with 61)

	Order no. W H D	Hinge side: Carcase depth	Price groups								
			1	2	3	4	5	6	7	8	9
 <p><b>Appliance unit</b> 1 door 51.6 cm 1 adjustable shelf 1 lifting door with front 38.6 cm 1 panel 1 appliance aperture 58.0 - 59.5 cm 1 pull-out 25.6 cm 1 pull-out 38.6 cm</p> <p> <b>Appliance unit with compensation door above appliance aperture</b></p>	58,0-59,5	R/L ▲	928	948	1005	1090	1129	1159	1221	1343	-
	GO 60 22 55 29 X3	R/L ▲	928	948	1005	1090	1129	1159	1221	1343	-

# Appliance unit 220.8 cm high for microwave / oven 30 inches wide (76.2 cm)

Carcase depth 55.5 cm (standard)

▲ = Types also available with 61 cm carcase depth (order no. ... replace ... 55 ... with 61)

	Order no. W H D	Hinge side: Carcase depth	Price groups								
			1	2	3	4	5	6	7	8	9
 <p><b>Appliance unit</b> 1 compensation door 3 adjustable shelves 1 appliance aperture 36.2 - 50 cm 1 door 77.6 cm 2 adjustable shelves</p>	76,2	R/L	589	615	683	799	846	889	966	1063	-
	GO 76 22 61 10 1A	R/L ▲	589	615	683	799	846	889	966	1063	-
 <p><b>Appliance unit</b> 1 compensation door 3 adjustable shelves 1 appliance aperture 36.2 - 50 cm 1 door 77.6 cm 2 adjustable shelves</p>	36,2-50,0		Not available for: ALUELEMENTS, FRAME, INTARSIA, MIAMI, STRIP ELEMENTS, VIVA								
	78										
 <p><b>Appliance unit</b> 1 compensation door 3 adjustable shelves 1 appliance aperture 36.2 - 50 cm 2 pull-outs 38.6 cm</p>	76,2	R/L ▲	1082	1111	1179	1293	1340	1383	1458	1604	-
	36,2-50,0		Not available for: ALUELEMENTS, FRAME, INTARSIA, MIAMI, STRIP ELEMENTS, VIVA								
 <p><b>Appliance unit</b> 1 compensation door 3 adjustable shelves 1 appliance aperture 36.2 - 50 cm 1 drawer 12.6 cm 1 pull-out 25.6 cm 1 pull-out 38.6 cm</p>	76,2	R/L ▲	1193	1220	1288	1403	1450	1494	1568	1725	-
	36,2-50,0		Not available for: ALUELEMENTS, FRAME, INTARSIA, MIAMI, STRIP ELEMENTS, VIVA								
 <p><b>Appliance unit</b> 1 compensation door 3 adjustable shelves 1 appliance aperture 37.3 - 50 cm 1 door 90.6 cm 3 adjustable shelves</p>	76,2	R/L ▲	589	615	683	799	846	889	966	1063	-
	37,3-50,0		Not available for: ALUELEMENTS, FRAME, INTARSIA, MIAMI, STRIP ELEMENTS, VIVA								
 <p><b>Appliance unit</b> 1 compensation door 3 adjustable shelves 1 appliance aperture 58.0 - 59.5 cm 1 door 77.6 cm 2 adjustable shelves</p>	76,2	R/L ▲	589	615	683	799	846	889	966	1063	-
	58,0-59,5		Not available for: ALUELEMENTS, FRAME, INTARSIA, MIAMI, STRIP ELEMENTS, VIVA								
 <p><b>Appliance unit</b> 1 compensation door 3 adjustable shelves 1 appliance aperture 58.0 - 59.5 cm 1 drawer 12.6 cm 1 pull-out 25.6 cm 1 pull-out 38.6 cm</p>	76,2	R/L ▲	1194	1217	1289	1389	1436	1480	1556	1712	-
	58,0-59,5		Not available for: ALUELEMENTS, FRAME, INTARSIA, MIAMI, STRIP ELEMENTS, VIVA								
 <p><b>Appliance unit</b> 1 compensation door 3 adjustable shelves 1 appliance aperture 58.0 - 59.5 cm 2 pull-outs 38.6 cm</p>	76,2	R/L ▲	1008	1035	1104	1222	1266	1309	1386	1525	-
	58,0-59,5		Not available for: ALUELEMENTS, FRAME, INTARSIA, MIAMI, STRIP ELEMENTS, VIVA								

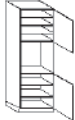
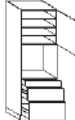
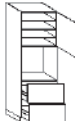
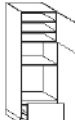
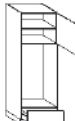


## Appliance unit 220.8 cm high for microwave / oven 30 inches wide (76.2 cm)

Carcase depth 55.5 cm (standard)

		Price groups								
		1	2	3	4	5	6	7	8	9
Order no. W H D										
Hinge side: Carcase depth										

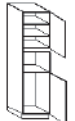



▲ = Types also available with 61 cm carcase depth (order no. ... replace ... 55 ... with 61)

776 	<b>Appliance unit</b> 1 compensation door 3 adjustable shelves 1 appliance aperture 66.0 - 71.8 cm 1 door 77.6 cm 2 adjustable shelves	76,2 66,0-71,8 78	GO 76 22 55 19 XA	R/L ▲	589	615	683	799	846	889	966	1063	-
	⚡ <b>Note:</b> Not available for: ALUELEMENTS, FRAME, INTARSIA, MIAMI, STRIP ELEMENTS, VIVA												
126 256 386 	<b>Appliance unit</b> 1 compensation door 3 adjustable shelves 1 appliance aperture 66.0 - 71.8 cm 1 drawer 12.6 cm 1 pull-out 25.6 cm 1 pull-out 38.6 cm	76,2 66,0-71,8 78	GO 76 22 55 19 2A	R/L ▲	1194	1217	1289	1389	1436	1480	1556	1712	-
	⚡ <b>Note:</b> Not available for: ALUELEMENTS, FRAME, INTARSIA, MIAMI, STRIP ELEMENTS, VIVA												
386 386 	<b>Appliance unit</b> 1 compensation door 3 adjustable shelves 1 appliance aperture 66.0 - 71.8 cm 2 pull-outs 38.6 cm	76,2 66,0-71,8 78	GO 76 22 55 19 X4A	R/L ▲	1008	1035	1104	1222	1266	1309	1386	1525	-
	⚡ <b>Note:</b> Not available for: ALUELEMENTS, FRAME, INTARSIA, MIAMI, STRIP ELEMENTS, VIVA												
256 	<b>Appliance unit</b> 1 compensation door 2 adjustable shelves 1 appliance aperture 45.0 cm 1 appliance aperture 71.8 cm 1 pull-out 25.6 cm	76,2 45,0 71,8	GO 76 22 55 17 XA2A	R/L ▲	777	804	874	988	1035	1078	1153	1268	-
	⚡ <b>Note:</b> Not available for: ALUELEMENTS, FRAME, INTARSIA, MIAMI, STRIP ELEMENTS, VIVA												
256 	<b>Appliance unit</b> 1 compensation door 2 adjustable shelves 1 appliance aperture 124.0 - 129.8 cm 1 pull-out 25.6 cm	76,2 124,0-129,8	GO 76 22 55 61 XA2A	R/L ▲	777	804	874	988	1035	1078	1153	1268	-
	⚡ <b>Note:</b> Not available for: ALUELEMENTS, FRAME, INTARSIA, MIAMI, STRIP ELEMENTS, VIVA												

## Appliance unit 220.8 cm high for refrigerator/freezer

Carcase depth 55.5 cm (standard)

▲ = Types also available with 61 cm carcase depth (order no. ... replace ... 55 ... with 61) Integrated ventilation not possible with appliances with motor in the plinth (Cool Concept)

776 906 	<b>Appliance unit</b> 1 door 77.6 cm 1 panel 1 appliance aperture 37.3 - 50 cm 1 integrated appliance aperture 72 - 88 cm 1 door 90.6 cm 2 adjustable shelves <b>Appliance unit with compensation door above appliance aperture</b>	37,3-50,0 72,0-88,0	GOI 60 22 55 11 X	R/L ▲	464	484	538	629	666	700	761	837	-
	💡 <b>Note:</b> Structural metal shelf at bottom Important: Observe the appliance manufacturers' permitted front weights for fixed door assembly. See overview of models for front weights.												
646 1036 	<b>Appliance unit</b> 1 door 64.6 cm 1 panel 1 appliance aperture 37.3 - 45 cm 1 integrated appliance aperture 102.3 cm 1 door 103.6 cm 2 adjustable shelves <b>Appliance unit with compensation door above appliance aperture</b>	37,3-45,0 102,3	GOI 60 22 55 12 X1	R/L ▲	535	557	611	700	737	770	830	913	-
	💡 <b>Note:</b> Structural metal shelf at bottom Important: Observe the appliance manufacturers' permitted front weights for fixed door assembly. See overview of models for front weights.												
516 1036 	<b>Appliance unit</b> 1 door 51.6 cm 1 panel 1 appliance aperture 58.0 - 59.5 cm 1 integrated appliance aperture 102.3 cm 1 door 103.6 cm 1 adjustable shelf <b>Appliance unit with compensation door above appliance aperture</b>	58,0-59,5 102,3	GOI 60 22 55 12 X2	R/L ▲	535	557	611	700	737	770	830	913	-
	💡 <b>Note:</b> Structural metal shelf at bottom Important: Observe the appliance manufacturers' permitted front weights for fixed door assembly. See overview of models for front weights.												
1063 	<b>Appliance unit</b> 2 adjustable shelves 1 appliance aperture 36.0 - 45 cm 1 integrated appliance aperture 102.5 cm 1 door 106.3 cm	36,0-45,0 102,5	GOI 60 22 55 12 X4A	R/L ▲	481	500	555	647	684	717	777	855	-
	💡 <b>Note:</b> Important: Observe the appliance manufacturers' permitted front weights for fixed door assembly. See overview of models for front weights.												



Models not available with compensation door: MIAMI, VIVA












# Appliance unit 220.8 cm high for refrigerator/freezer

Carcase depth 55.5 cm (standard)

▲ = Types also available with 61 cm carcass depth (order no. ... replace ... 55 ... with 61)  
Integrated ventilation not possible with appliances with motor in the plinth (Cool Concept)

Order no.  
W H D

Hinge side:	Carcass depth	Price groups									
		1	2	3	4	5	6	7	8	9	
R/L ▲	30,8-37,2	<b>GOI 60 22 55 02 X</b>	464	484	538	629	666	700	761	837	-
	88,0-103,0	 Important: Observe the appliance manufacturers' permitted front weights for fixed door assembly. See overview of models for front weights.									
R/L ▲		<b>GOI 60 22 55 02 XA</b>	464	484	538	629	666	700	761	837	-
R/L ▲	30,8-37,2	<b>GOIB 60 22 55 02 X</b>	481	500	555	647	684	717	777	855	-
	88,0-103,0	 Important: Observe the appliance manufacturers' permitted front weights for fixed door assembly. See overview of models for front weights.									
R/L ▲		<b>GOIB 60 22 55 02 XA</b>	481	500	555	647	684	717	777	855	-
R/L ▲	37,3-50,0	<b>GOI 60 22 55 12 X</b>	464	484	538	629	666	700	761	837	-
	88,0-103,0	 Important: Observe the appliance manufacturers' permitted front weights for fixed door assembly. See overview of models for front weights.									
R/L ▲		<b>GOI 60 22 55 12 XA</b>	464	484	538	629	666	700	761	837	-
R/L ▲	37,3-50,0	<b>GOIB 60 22 55 12 X</b>	481	500	555	647	684	717	777	855	-
	88,0-103,0	 Important: Observe the appliance manufacturers' permitted front weights for fixed door assembly. See overview of models for front weights.									
R/L ▲		<b>GOIB 60 22 55 12 XA</b>	481	500	555	647	684	717	777	855	-
R/L ▲	37,3-50,0	<b>GOI 60 22 55 13 X</b>	464	484	538	629	666	700	761	837	-
	122,5	 Important: Observe the appliance manufacturers' permitted front weights for fixed door assembly. See overview of models for front weights.									
R/L ▲		<b>GOI 60 22 55 13 XA</b>	464	484	538	629	666	700	761	837	-
R/L ▲	58,0-59,5	<b>GOI 60 22 55 21 X</b>	464	484	538	629	666	700	761	837	-
	88,0	 Note: Structural metal shelf at bottom  Important: Observe the appliance manufacturers' permitted front weights for fixed door assembly. See overview of models for front weights.									
R/L ▲		<b>GOI 60 22 55 21 XA</b>	464	484	538	629	666	700	761	837	-
R/L ▲	88,0	<b>GI 60 22 55 35 X</b>	597	616	674	760	796	828	890	979	-
		 Important: Observe the appliance manufacturers' permitted front weights for fixed door assembly. See overview of models for front weights.									
R/L ▲		<b>GI 60 22 55 30 X</b>	487	501	578	719	810	856	933	1026	-
R/L ▲	88,0	<b>GI 60 22 55 30 X2</b>	819	835	909	1044	1135	1182	1258	1384	-
		 Important: Observe the appliance manufacturers' permitted front weights for fixed door assembly. See overview of models for front weights.									
R/L ▲		<b>GIB 60 22 55 30 X2</b>	836	852	926	1061	1152	1199	1275	1403	-



# Appliance unit 220.8 cm high for refrigerator/freezer

Carcase depth 55.5 cm (standard)

▲ = Types also available with 61 cm carcass depth (order no. ... replace ... 55 ... with 61)  
 Integrated ventilation not possible with appliances with motor in the plinth (Cool Concept)

Order no.  
 W H D

Hinge side: Carcass depth	Price groups														
	1	2	3	4	5	6	7	8	9						
R/L ▲	GI	60	22	55	40	X	487	501	578	719	810	856	933	1026	-
	Important: Observe the appliance manufacturers' permitted front weights for fixed door assembly. See overview of models for front weights.														
R/L ▲	GIB	60	22	55	40	X	504	517	595	736	827	873	950	1045	-
R/L ▲	GI	60	22	55	40	X2	819	835	909	1044	1135	1182	1258	1384	-
	Important: Observe the appliance manufacturers' permitted front weights for fixed door assembly. See overview of models for front weights.														
R/L ▲	GIB	60	22	55	40	X2	836	852	926	1061	1152	1199	1275	1403	-
R/L ▲	GI	60	22	55	55	01	509	530	603	743	834	880	961	1057	-
	Important: Observe the appliance manufacturers' permitted front weights for fixed door assembly. See overview of models for front weights.														
R/L ▲	GIB	60	22	55	55	01	503	517	594	735	826	872	949	1044	-
R/L ▲	GI	60	22	55	50	X	487	501	578	719	810	856	933	1026	-
	Important: Observe the appliance manufacturers' permitted front weights for fixed door assembly. See overview of models for front weights.														
R/L ▲	GIB	60	22	55	50	X	503	517	594	735	826	872	949	1044	-
R/L ▲	GI	60	22	55	50	X1	637	652	727	864	957	1003	1082	1190	-
	Important: Observe the appliance manufacturers' permitted front weights for fixed door assembly. See overview of models for front weights.														
R/L ▲	GIB	60	22	55	50	X1	653	669	744	881	974	1020	1098	1208	-
R/L ▲	GI	60	22	55	50	X4	673	688	763	900	993	1039	1118	1230	-
	Important: Observe the appliance manufacturers' permitted front weights for fixed door assembly. See overview of models for front weights.														
R/L ▲	GIB	60	22	55	50	X4	689	704	779	916	1009	1055	1134	1247	-
R/L ▲	GI	60	22	55	62	011	487	501	578	719	810	856	933	1026	-
	Important: Observe the appliance manufacturers' permitted front weights for fixed door assembly. See overview of models for front weights.														
R/L ▲	GIB	60	22	55	62	011	487	501	578	719	810	856	933	1026	-
R/L ▲	GI	60	22	55	62	012	637	652	727	864	957	1003	1082	1190	-
	Important: Observe the appliance manufacturers' permitted front weights for fixed door assembly. See overview of models for front weights.														
R/L ▲	GIB	60	22	55	62	012	637	652	727	864	957	1003	1082	1190	-
R/L ▲	GI	60	22	55	62	013	637	652	727	864	957	1003	1082	1190	-
	Important: Observe the appliance manufacturers' permitted front weights for fixed door assembly. See overview of models for front weights.														
R/L ▲	GIB	60	22	55	62	013	637	652	727	864	957	1003	1082	1190	-
R/L ▲	GI	60	22	55	68	X3	487	501	578	719	810	856	933	1026	-
	Important: Observe the appliance manufacturers' permitted front weights for fixed door assembly. See overview of models for front weights.														
R/L ▲	GIB	60	22	55	68	X3	487	501	578	719	810	856	933	1026	-
R/L ▲	GI	60	22	55	68	X2	487	501	578	719	810	856	933	1026	-
	Important: Observe the appliance manufacturers' permitted front weights for fixed door assembly. See overview of models for front weights.														
R/L ▲	GIB	60	22	55	68	X2	487	501	578	719	810	856	933	1026	-



78

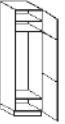




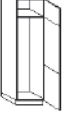






Models not available with compensation door: MIAMI, VIVA

# Appliance unit 220.8 cm high for refrigerator/freezer

Carcase depth 55.5 cm (standard)

▲ = Types also available with 61 cm carcass depth (order no. ... replace ... 55 ... with 61)  
Integrated ventilation not possible with appliances with motor in the plinth (Cool Concept)

		Order no.		Hinge side:		Price groups									
		W H D		Carcass depth		1	2	3	4	5	6	7	8	9	
451 906 841		<b>Appliance unit</b> 1 door 45.1 cm 1 integrated appliance aperture 144.6 cm 1 door 90.6 cm attached to 1 door 84.1 cm		144,6	GI 60 22 55 68 X8	R/L ▲	487	501	578	719	810	856	933	1026	-
				84,5	Important: Observe the appliance manufacturers' permitted front weights for fixed door assembly. See overview of models for front weights.										
1426 776		<b>Appliance unit</b> 1 integrated appliance aperture 177.0 - 194.0 cm 1 door 142.6 cm 1 door 77.6 cm		177,0-194,0	GI 60 22 55 89 X5	R/L ▲	487	501	578	719	810	856	933	1026	-
		<b>Appliance unit with integrated ventilation</b>		78	GIB 60 22 55 89 X5	R/L ▲	504	517	595	736	827	873	950	1045	-
516 906 776		<b>Appliance unit</b> 1 door 51.6 cm 1 integrated appliance aperture 158 cm 1 door 90.6 cm 1 door 77.6 cm 1 adjustable shelf		158,0	GI 60 22 55 79 02A	R/L ▲	487	501	578	719	810	856	933	1026	-
				78	Important: Observe the appliance manufacturers' permitted front weights for fixed door assembly. See overview of models for front weights.										
256 1166 776		<b>Appliance unit</b> 1 flap door 25.6 cm 1 integrated appliance aperture 178 cm 1 door 116.6 cm 1 door 77.6 cm, supplied separately		178,0	GI 60 22 55 92 41	R/L ▲	487	501	578	719	810	856	933	1026	-
		<b>Appliance unit with integrated ventilation</b>		78	GIB 60 22 55 92 41	R/L ▲	503	517	594	735	826	872	949	1044	-
256 1166 776		<b>Appliance unit</b> 1 flap door 25.6 cm 1 integrated appliance aperture 177.0 - 178.5 cm 1 door 116.6 cm 1 door 77.6 cm		177,0-178,5	GI 60 22 55 89 X2	R/L ▲	487	501	578	719	810	856	933	1026	-
				78	Important: Observe the appliance manufacturers' permitted front weights for fixed door assembly. See overview of models for front weights.										
386 1036 776		<b>Appliance unit</b> 1 door 38.6 cm 1 integrated appliance aperture 177.0 - 178.5 cm 1 door 103.6 cm connected to 1 door 77.6 cm		177,0-178,5	GI 60 22 55 92 03	R/L ▲	487	501	578	719	810	856	933	1026	-
				78	Important: Observe the appliance manufacturers' permitted front weights for fixed door assembly. See overview of models for front weights.										
2206		<b>Appliance unit</b> 1 door 220.6 cm 1 integrated appliance aperture 177.0 - 178.5 cm		177,0-178,5	GI 60 22 55 92 08	R/L ▲	568	583	657	800	894	936	1015	1117	-
		<b>Appliance unit with integrated ventilation</b>			Width 60 Not available for: ALUELEMENTS, ATLANTA-B, ATLANTA-S, BERGEN, CASTELLO, CHALET-B, CHALET-S, CHICAGO, FRAME, GARDA, LUGANO, LUX-B, MODENA, MUNICH, NEVADA, NOBEL-B, NOBEL-S, ORLANDO-B, ORLANDO-S, OSLO 15, PADUA, SOFIE-B, SOFIE-S, TESSIN 15, TIM 15, TREND, VINO, YORK-B, YORK-S										
					The tightening fitting will be replaced with carrying-door technology on appliance units. Important: Observe the appliance manufacturers' permitted front weights for fixed door assembly. See overview of models for front weights.										
					GIB 60 22 55 92 08	R/L ▲	584	601	675	816	908	954	1032	1135	-
1361 841		<b>Appliance unit</b> 1 integrated appliance aperture 177.0 - 178.5 cm 1 door 136.1 cm 1 door 84.1 cm		177,0-178,5	GI 60 22 55 89 X8	R/L ▲	487	501	578	719	810	856	933	1026	-
				84,5	Important: Observe the appliance manufacturers' permitted front weights for fixed door assembly. See overview of models for front weights.										
				NEW											
1361 841		<b>Appliance unit with integrated ventilation</b> 1 integrated appliance aperture 177.0 - 178.5 cm 1 door 136.1 cm connected to 1 door 84.1 cm		177,0-178,5	GIB 60 22 55 89 X8V	R/L ▲	502	518	595	735	828	872	950	1045	-
				84,5	Important: Observe the appliance manufacturers' permitted front weights for fixed door assembly. See overview of models for front weights.										
				NEW											
256 1296 646		<b>Appliance unit</b> 1 flap door 25.6 cm 1 integrated appliance aperture 177.0 - 178.5 cm 1 door 129.6 cm 1 door 64.6 cm		177,0-178,5	GI 60 22 55 89 X4	R/L ▲	487	501	578	719	810	856	933	1026	-
					Important: Observe the appliance manufacturers' permitted front weights for fixed door assembly. See overview of models for front weights.										
					GIB 60 22 55 89 X4	R/L ▲	503	517	594	735	826	872	949	1044	-



# Appliance unit 220.8 cm high for refrigerator/freezer Double aperture


Carcase depth 55.5 cm (standard)

▲ = Types also available with 61 cm carcass depth (order no. ... replace ... 55 ... with 61)  
 Integrated ventilation not possible with appliances with motor in the plinth (Cool Concept)

Order no.  
 W H D

Hinge side: Carcass depth	Price groups								
	1	2	3	4	5	6	7	8	9
R/L ▲	487	501	578	719	810	856	933	1026	-
R/L ▲	503	517	594	735	826	872	949	1042	-
R/L ▲	503	517	594	735	826	872	949	1044	-
R/L ▲	487	501	578	719	810	856	933	1026	-

516  
906  
776




**Appliance unit**  
 1 door 51.6 cm  
 1 integrated appliance aperture 88 cm  
 1 door 90.6 cm  
 1 integrated appliance aperture 58 - 72 cm  
 1 door 77.6 cm  
 1 adjustable shelf

88,0  
 58,0-72,0  
 78

**GI 60 22 55 32 X** R/L ▲

Important: Observe the appliance manufacturers' permitted front weights for fixed door assembly. See overview of models for front weights.

1361  
841




**Appliance unit with integrated ventilation**  
 1 integrated appliance aperture 122.5 cm  
 1 door 136.1 cm  
 1 integrated appliance aperture 72 cm  
 1 door 84.1 cm

122,5  
 72,0  
 84,5  
 NEW

**GIB 60 22 55 52 X8** R/L ▲

Important: Observe the appliance manufacturers' permitted front weights for fixed door assembly. See overview of models for front weights.

1361  
841




**Appliance unit with integrated ventilation**  
 1 integrated appliance aperture 103 cm  
 1 door 136.1 cm  
 1 integrated appliance aperture 72 cm  
 1 door 84.1 cm

103,0  
 72,0  
 84,5  
 NEW

**GIB 60 22 55 42 X8** R/L ▲

Important: Observe the appliance manufacturers' permitted front weights for fixed door assembly. See overview of models for front weights.

386  
906  
906



**Appliance unit**  
 1 door 38.6 cm  
 1 integrated appliance aperture 88 cm  
 1 door 90.6 cm  
 1 integrated appliance aperture 72 - 88 cm  
 1 door 90.6 cm

88,0  
 72,0-88,0


**GI 60 22 55 33 X** R/L ▲

Important: Observe the appliance manufacturers' permitted front weights for fixed door assembly. See overview of models for front weights.

## Tall units 220.8 cm high Widths: 75 cm

Carcass depth 55.5 cm (standard) Widths: 75 cm  
 Integrated ventilation not possible with appliances with motor in the plinth (Cool Concept)  
 ■ = Models also available in 34/45.5/61 cm carcass depth (Order no.: ... replace ... 55 ... with 34/45/61) ▲ = Types also available with 61 cm carcass depth (order no. ... replace ... 55 ... with 61)

1426  
776



**Crockery cupboard**  
 1 door 142.6 cm  
 1 door 77.6 cm  
 1 fixed shelf  
 6 adjustable shelves

75  
 78

**GG 75 22 55 01** R/L ■

Width 75 Not available for: ALUELEMENTS, FRAME, MIAMI, STRIP ELEMENTS, VIVA

The adjustable shelves will be delivered as a separate package.

2206



**Crockery cupboard**  
 1 door 220.6 cm  
 1 fixed shelf  
 6 adjustable shelves


75

**GG 75 22 55 70** R/L ■

Width 75 Not available for: ALUELEMENTS, ATLANTA-B, ATLANTA-S, BERGEN, CASTELLO, CHALET-B, CHALET-S, CHICAGO, FRAME, GARDA, LUGANO, LUX-B, MIAMI, MODENA, MUNICH, NEVADA, NOBEL-B, NOBEL-S, ORLANDO-B, ORLANDO-S, OSLO 15, PADUA, SOFIE-B, SOFIE-S, TESSIN 15, TIM 15, TREND, VINO, VIVA, YORK-B, YORK-S

Each front has a tightening fitting  
 Ranges without fitting: SMARTGLAS, NOBEL, SOFIE, YORK, LUGANO, TALEA, RIVA, GARDA, ATLANTA, ORLANDO, CHICAGO without tightening fitting  
 The adjustable shelves will be delivered as a separate package.

1426  
776



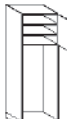
**Appliance unit**  
 1 integrated appliance aperture 177.0 - 194.0 cm  
 1 door 142.6 cm  
 1 door 77.6 cm

177,0-194,0  
 75  
 78

**GI 75 22 55 89 X5** R/L ▲

Width 75 Not available for: ALUELEMENTS, FRAME, MIAMI, STRIP ELEMENTS, VIVA

Important: Observe the appliance manufacturers' permitted front weights for fixed door assembly. See overview of models for front weights.



**Appliance unit**  
 1 compensation door  
 2 adjustable shelves  
 1 appliance aperture 154.0 - 166.7 cm

76,2  
 154,0-166,7  
 NEW

**GO 76 22 55 73 A** R/L ▲

Width 76 Not available for: ALUELEMENTS, FRAME, INTARSIA, MIAMI, STRIP ELEMENTS, VIVA



























Models not available with compensation door: MIAMI, VIVA




# Fronts for Side by Side refrigerators/freezers 220.8 cm high

Carcase depth 55.5 cm (standard)

		Order no.		Hinge side:		Price groups								
		W H D		Carcase depth		1	2	3	4	5	6	7	8	9
2206	 <p><b>Front for Side by Side integrated freezer</b> Suitable for carcase height 220.8 cm Dimensions: Height: 220.6 cm Width: 45.1 cm without handle drill holes</p>	GT	SBS 45 22			161	291	474	760	789	812	1099	1209	-
		 <p><b>Width 45 Available for:</b> ALU TEC RP, ARTE-B, ARTE-S, BAVARIA, CASA-B, EDITION, FENIX INOX, FLORENZ, GENT, HPL PRO, MALMÖ, MONTANA, MPX, NEW OPAL-M, OPAL-H, PALAZZO, PALERMO-B, PALERMO-S, PRIMEWOOD TOP, PUR, RESOPAL, RESOPAL PRO, RESOPAL PRO EDGE, RIVA, ROMA-B, ROMA-S, RUSTY OAK, SHERWOOD, SIGNUM-B, SMART, SMART MIRROR, SMART-M, TALEA, TIM, TOP, VILLAGE 15-B, VILLAGE 15-S</p>		 <p>Note: When planning, the minimum base height is 10 cm Important: The front is designed for installation between two tall units. Grip ledges not possible</p>										
2206	 <p><b>Front for Side by Side integrated fridge and freezer</b> Suitable for carcase height 220.8 cm Dimensions: Height: 220.6 cm Width: 60.3 cm without handle drill holes</p>	GT	SBS 60 22			215	388	633	1016	1055	1085	1470	1617	-
		 <p><b>Width 60 Available for:</b> ALU TEC RP, ARTE-B, ARTE-S, BAVARIA, CASA-B, EDITION, FENIX INOX, FLORENZ, GENT, HPL PRO, MALMÖ, MONTANA, MPX, NEW OPAL-M, OPAL-H, PALAZZO, PALERMO-B, PALERMO-S, PRIMEWOOD TOP, PUR, RESOPAL, RESOPAL PRO, RESOPAL PRO EDGE, RIVA, ROMA-B, ROMA-S, RUSTY OAK, SHERWOOD, SIGNUM-B, SMART, SMART MIRROR, SMART-M, TALEA, TIM, TOP, VILLAGE 15-B, VILLAGE 15-S</p>		 <p>Note: When planning, the minimum base height is 10 cm Important: The front is designed for installation between two tall units. Grip ledges not possible</p>										
2206	 <p><b>Front for Side by Side integrated fridge and freezer</b> Suitable for carcase height 220.8 cm Dimensions: Height: 220.6 cm Width: 75.6 cm without handle drill holes</p>	GT	SBS 76 22			270	487	794	1274	1323	1361	1843	2027	-
		 <p><b>Width 75 Available for:</b> ALU TEC RP, ARTE-B, ARTE-S, BAVARIA, CASA-B, EDITION, FENIX INOX, FLORENZ, GENT, HPL PRO, MALMÖ, MONTANA, MPX, NEW OPAL-M, OPAL-H, PALAZZO, PALERMO-B, PALERMO-S, PRIMEWOOD TOP, PUR, RESOPAL, RESOPAL PRO, RESOPAL PRO EDGE, RIVA, ROMA-B, ROMA-S, RUSTY OAK, SHERWOOD, SIGNUM-B, SMART, SMART MIRROR, SMART-M, TALEA, TIM, TOP, VILLAGE 15-B, VILLAGE 15-S</p>		 <p>Note: When planning, the minimum base height is 10 cm Important: The front is designed for installation between two tall units. Grip ledges not possible</p>										
2206	 <p><b>Front for Side by Side integrated fridge and freezer</b> Suitable for carcase height 220.8 cm Dimensions: Height: 220.6 cm Width: 90.8 cm without handle drill holes</p>	GT	SBS 91 22			324	585	953	1530	1588	1634	2213	2434	-
		 <p><b>Width 90 Available for:</b> ALU TEC RP, ARTE-B, ARTE-S, BAVARIA, CASA-B, EDITION, FENIX INOX, FLORENZ, GENT, HPL PRO, MALMÖ, MONTANA, MPX, NEW OPAL-M, OPAL-H, PALAZZO, PALERMO-B, PALERMO-S, PRIMEWOOD TOP, PUR, RESOPAL, RESOPAL PRO, RESOPAL PRO EDGE, RIVA, ROMA-B, ROMA-S, RUSTY OAK, SHERWOOD, SIGNUM-B, SMART, SMART MIRROR, SMART-M, TALEA, TIM, TOP, VILLAGE 15-B, VILLAGE 15-S</p>		 <p>Note: When planning, the minimum base height is 10 cm Important: The front is designed for installation between two tall units. Grip ledges not possible</p>										
2206	 <p><b>Front for Side by Side integrated fridge and freezer</b> Suitable for carcase height 220.8 cm Dimensions: Front 1: height 72.4 cm, width 90.8 cm Front 2: height 147.9 cm, width 90.8 cm without handle drill holes</p>	GT2	SBS 91 22			324	584	952	1528	1586	1632	2210	2431	-
		 <p><b>Width 90 Available for:</b> ALU TEC RP, ARTE-B, ARTE-S, BAVARIA, CASA-B, EDITION, FENIX INOX, FLORENZ, GENT, HPL PRO, MALMÖ, MONTANA, MPX, NEW OPAL-M, OPAL-H, PALAZZO, PALERMO-B, PALERMO-S, PRIMEWOOD TOP, PUR, RESOPAL, RESOPAL PRO, RESOPAL PRO EDGE, RIVA, ROMA-B, ROMA-S, RUSTY OAK, SHERWOOD, SIGNUM-B, SMART, SMART MIRROR, SMART-M, TALEA, TIM, TOP, VILLAGE 15-B, VILLAGE 15-S</p>		 <p>Note: When planning, the minimum base height is 10 cm Important: The front is designed for installation between two tall units. Grip ledges not possible</p>										
2206	 <p><b>Front for Side by Side integrated fridge and freezer</b> Suitable for carcase height 220.8 cm Dimensions: Front 1: height 72.4 cm, width 90.8 cm Front 2: height 147.9 cm, width 45.2 cm Front 3: height 147.9 cm, width 45.2 cm without handle drill holes</p>	GT3	SBS 91 22			323	582	949	1524	1582	1627	2204	2424	-
		 <p><b>Width 90 Available for:</b> ALU TEC RP, ARTE-B, ARTE-S, BAVARIA, CASA-B, EDITION, FENIX INOX, FLORENZ, GENT, HPL PRO, MALMÖ, MONTANA, MPX, NEW OPAL-M, OPAL-H, PALAZZO, PALERMO-B, PALERMO-S, PRIMEWOOD TOP, PUR, RESOPAL, RESOPAL PRO, RESOPAL PRO EDGE, RIVA, ROMA-B, ROMA-S, RUSTY OAK, SHERWOOD, SIGNUM-B, SMART, SMART MIRROR, SMART-M, TALEA, TIM, TOP, VILLAGE 15-B, VILLAGE 15-S</p>		 <p>Note: When planning, the minimum base height is 10 cm Important: The front is designed for installation between two tall units. Grip ledges not possible</p>										
2206	 <p><b>Front for Side by Side integrated wine chiller with glass door</b> Framed front, 1 piece Suitable for carcase height 220.8 cm Dimensions: Height: 220.6 cm Width: 45.1 cm without handle drill holes please order the handles separately Suitable for Gaggenau and Liebherr</p>	GT	SBS WK 45 22			-	-	624	910	969	992	1279	1407	-
		 <p><b>Width 45 Available for:</b> ARTE-B, ARTE-S, ATLANTA-B, ATLANTA-S, CASA-B, NEW OPAL-M, OPAL-H, PALAZZO, PALERMO-B, PALERMO-S, ROMA-B, ROMA-S, SIGNUM-B, VILLAGE 15-B, VILLAGE 15-S</p>		 <p>Note: When planning, the minimum base height is 10 cm Important: The front is designed for installation between two tall units. Grip ledges not possible</p>										
2206	 <p><b>Front for Side by Side integrated wine chiller with glass door</b> Framed front, 1 piece Suitable for carcase height 220.8 cm Dimensions: Height: 220.6 cm Width: 60.3 cm without handle drill holes please order the handles separately Suitable for Miele, Gaggenau and Liebherr</p>	GT	SBS WK 60 22			-	-	783	1166	1235	1265	1650	1815	-
		 <p><b>Width 60 Available for:</b> ARTE-B, ARTE-S, ATLANTA-B, ATLANTA-S, CASA-B, NEW OPAL-M, OPAL-H, PALAZZO, PALERMO-B, PALERMO-S, ROMA-B, ROMA-S, SIGNUM-B, VILLAGE 15-B, VILLAGE 15-S</p>		 <p>Note: When planning, the minimum base height is 10 cm Important: The front is designed for installation between two tall units. Grip ledges not possible</p>										

## spacefitter frame 220.8 cm high

1426 776	 <p><b>Tall unit spacefitter frame</b> 1 door 142.6 cm connected to 1 door 77.6 cm Carcase depth 10 cm For recess cladding</p>	78	GPR 30 22 10 01	R/L	255	263	302	392	409	430	478	526	-
			GPR 45 22 10 01	R/L	255	263	302	392	409	430	478	526	-
			GPR 50 22 10 01	R/L	255	263	302	423	439	465	508	559	-
			GPR 60 22 10 01	R/L	282	298	339	494	523	550	603	663	-

# spacefitter frame 220.8 cm high

Hinge side:	Carcase depth	Price groups								
		1	2	3	4	5	6	7	8	9

1426  
776

**Tall unit spacefitter frame with swivelling plinth**  
1 door 142.6 cm connected to 1 door 77.6 cm  
Carcase depth 10 cm  
Without bottom shelf  
With swivelling plinth

Order no. W H D

78

GPRS 60 22 10 01	R/L	337	353	393	549	577	605	656	722	-
GPRS 70 22 10 01	R/L	522	566	647	866	901	934	1048	1153	-
GPRS 80 22 10 01	R/L	557	631	752	1036	1075	1114	1293	1422	-

Width 60  
Width 70, 80 Not available for: ALUELEMENTS, CASTELLO, FRAME, MIAMI, STRIP ELEMENTS, VIVA

💡 Planning advice: only for planning between tall units

1361  
841

**Tall unit spacefitter frame with swivelling plinth**  
1 door 136.1 cm connected to 1 door 84.1 cm  
Carcase depth 10 cm  
Without bottom shelf  
With swivelling plinth

84,5

GPRS 60 22 10 05	R/L	337	353	393	549	577	605	656	722	-
GPRS 70 22 10 05	R/L	522	566	647	866	901	934	1048	1153	-
GPRS 80 22 10 05	R/L	557	631	752	1036	1075	1114	1293	1422	-

Width 60 Not available for: MIAMI, VIVA  
Width 70, 80 Not available for: ALUELEMENTS, CASTELLO, FRAME, MIAMI, STRIP ELEMENTS, VIVA

💡 Planning advice: only for planning between tall units

## Passage door elements Carcase depth 55.5 cm (standard)

1426  
776

**Passage door element**  
1 door 142.6 cm connected to 1 door 77.6 cm  
Without bottom shelf  
With swivelling plinth

Planning advice:  
only for planning  
between  
tall units.

78

GDT 60 22 55 01	R/L ▲	427	447	508	772	831	867	949	1044	-
GDT 70 22 55 01	R/L ▲	612	661	761	1090	1155	1197	1341	1475	-
GDT 80 22 55 01	R/L ▲	648	725	866	1258	1329	1376	1585	1744	-

Width 60  
Width 70, 80 Not available for: ALUELEMENTS, CASTELLO, FRAME, MIAMI, STRIP ELEMENTS, VIVA

💡 The article comprises several packages and is supplied dismantled.  
Planning advice: only for planning between tall units  
Width 80 cm = grip strip N775 not available

1426  
776

**Passage door element**  
2 doors 142.6 cm connected with 2 doors 77.6 cm  
Without bottom shelf  
With swivelling plinth

78

GDT 90 22 55 01	▲	875	909	1006	1165	1229	1287	1393	1532	-
GDT 100 22 55 01	▲	962	1001	1108	1282	1352	1415	1532	1685	-
GDT 120 22 55 01	▲	1048	1092	1207	1398	1474	1544	1672	1839	-

💡 The article comprises several packages and is supplied dismantled.  
Planning advice: only for planning between tall units

1361  
841

**Passage door element**  
1 door 136.1 cm connected to 1 door 84.1 cm  
Without bottom shelf  
With swivelling plinth

84,5

GDT 60 22 55 05	R/L ▲	427	447	508	772	831	867	949	1044	-
GDT 70 22 55 05	R/L ▲	612	661	761	1090	1155	1197	1341	1475	-
GDT 80 22 55 05	R/L ▲	648	725	866	1258	1329	1376	1585	1744	-

Width 60 Not available for: MIAMI, VIVA  
Width 70, 80 Not available for: ALUELEMENTS, CASTELLO, FRAME, MIAMI, STRIP ELEMENTS, VIVA

💡 The article comprises several packages and is supplied dismantled.  
Planning advice: only for planning between tall units  
Width 80 cm = grip strip N775 not available

2206

**Passage door element**  
1 door 220.6 cm  
Without bottom shelf  
With swivelling plinth

Planning advice:  
only for planning  
between  
tall units.

GDT 60 22 55 70	R/L ▲	508	530	588	852	911	949	1029	1132	-
GDT 70 22 55 70	R/L ▲	728	780	879	1206	1272	1314	1459	1605	-
GDT 80 22 55 70	R/L ▲	764	844	985	1375	1446	1495	1703	1873	-

Width 60, 70, 80 Not available for: ALUELEMENTS, ATLANTA-B, ATLANTA-S, BERGEN, CASTELLO, CHALET-B, CHALET-S, CHICAGO, FRAME, GARDA, LUGANO, LUX-B, MIAMI, MODENA, MUNICH, NEVADA, NOBEL-B, NOBEL-S, ORLANDO-B, ORLANDO-S, OSLO 15, PADUA, SOFIE-B, SOFIE-S, TESSIN 15, TIM 15, TREND, VINO, VIVA, YORK-B, YORK-S

💡 The article comprises several packages and is supplied dismantled.  
Each front has a tightening fitting  
Ranges without fitting: SMARTGLAS, NOBEL, SOFIE, YORK, LUGANO, TALEA, RIVA, GARDA, ATLANTA, ORLANDO, CHICAGO without tightening fitting  
Planning advice: only for planning between tall units

2206

**Passage door element**  
2 doors 220.6 cm  
Without bottom shelf  
With swivelling plinth

GDT 90 22 55 70	▲	1037	1071	1167	1326	1391	1449	1554	1709	-
GDT 100 22 55 70	▲	1140	1178	1284	1459	1530	1593	1710	1881	-
GDT 120 22 55 70	▲	1244	1286	1401	1592	1668	1738	1866	2053	-

Width 90, 100, 120 Not available for: ALUELEMENTS, ATLANTA-B, ATLANTA-S, BERGEN, CASTELLO, CHALET-B, CHALET-S, CHICAGO, FRAME, GARDA, LUGANO, LUX-B, MIAMI, MODENA, MUNICH, NEVADA, NOBEL-B, NOBEL-S, ORLANDO-B, ORLANDO-S, OSLO 15, PADUA, SOFIE-B, SOFIE-S, TESSIN 15, TIM 15, TREND, VINO, VIVA, YORK-B, YORK-S

💡 Each front has a tightening fitting  
Ranges without fitting: SMARTGLAS, NOBEL, SOFIE, YORK, LUGANO, TALEA, RIVA, GARDA, ATLANTA, ORLANDO, CHICAGO without tightening fitting  
The article comprises several packages and is supplied dismantled.  
Planning advice: only for planning between tall units

2076

**Passage door element**  
1 door 220.6 cm  
Without bottom shelf  
with front extension downwards  
(depending on the plinth height - max. 20 cm)

GDTV 60 22 55 70	R/L ▲	643	666	729	1020	1110	1162	1256	1382	-
GDTV 70 22 55 70	R/L ▲	917	967	1053	1382	1464	1516	1545	1700	-
GDTV 80 22 55 70	R/L ▲	970	1061	1208	1629	1734	1794	1894	2083	-

Width 60, 70, 80 Not available for: ALUELEMENTS, ATLANTA-B, ATLANTA-S, BERGEN, CASTELLO, CHALET-B, CHALET-S, CHICAGO, FRAME, GARDA, LUGANO, LUX-B, MIAMI, MODENA, MUNICH, NEVADA, NOBEL-B, NOBEL-S, ORLANDO-B, ORLANDO-S, OSLO 15, PADUA, SOFIE-B, SOFIE-S, TESSIN 15, TIM 15, TREND, VINO, VIVA, YORK-B, YORK-S

💡 The article comprises several packages and is supplied dismantled.  
Each front has a tightening fitting  
Ranges without fitting: SMARTGLAS, NOBEL, SOFIE, YORK, LUGANO, TALEA, RIVA, GARDA, ATLANTA, ORLANDO, CHICAGO without tightening fitting  
Planning advice: only for planning between tall units

# Passage door elements

Carcase depth 55.5 cm (standard)

Order no.  
W H D

Hinge side:	Carcase depth	Price groups								
		1	2	3	4	5	6	7	8	9

**Through-door with pivot door fitting Version:**

The through-door with pivot door fitting is planned as an intermediate construction variant at the top with a fixed panel (front and rear). The door is a doubled front with integrated fittings.

**Planning dimensions:**

Planning widths: 80 cm (variable from 70.1 cm to 80 cm)

Planning depth: 55.5 cm = carcase depth

Planning heights: 207.8 cm and 220.8 cm + plinth height

Note: The front heights match units with a height of 207.8 cm or 220.8 cm with a front extension with a clearance of 1.5 cm from the floor.

The maximum plinth height is 10 cm.

**Important:**

The door turns inward beyond the cabinet depth of 55.5 cm!

The pivot range must be taken into account in accordance with the floor plan drawing (see below).

If the door cannot swing inwards freely, the row of units must be pulled forward and increased side depths must be taken into account for the adjacent units!

**Planning notes:**

Only through-doors are available.

The passage door with pivot door fitting can only be planned between tall cabinets or between tall cabinets and a wall.

Directly connected fillers are not possible!

The set does not contain panels.

Further planning is only possible with a cabinet height of 207.8 cm or 220.8 cm. Offset!

The maximum plinth height is 10 cm. Here, any front extensions are to be taken into consideration.

**Further information:**

The lower fitting must not be affixed to the base shelf. The lower door guide is connected to the unit side of the tall unit planned next to it or to a wall using a mounting bracket.

**Very important note:**

Due to the inward turning function, the vertical joint dimensions of the swing door deviate from the standard dimensions.

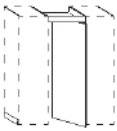
For technical reasons, a larger gap dimension is necessary here. Due to the hardware technology used and the resulting kinematics, an exactly flush alignment of the element cannot be guaranteed in every case.

**Material design**

Front:	front colour / model
front doubling inside:	carcase colour
intermediate installation:	carcase colour
panels:	front colour / model

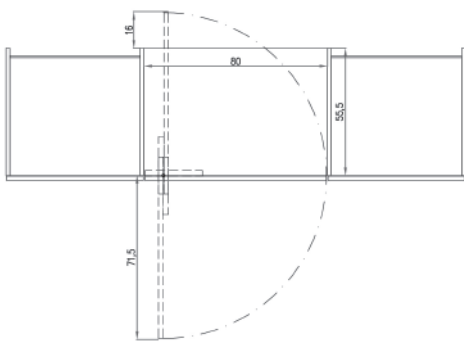
The maximum plinth height is 10 cm

2206



**Through-door with pivot fitting for tall unit rows**

consisting of:  
 1 continuous door opening inwards, extended by plinth height and with a 1.5 cm distance to the floor incl. front doubling on the inside  
 Door width 70.1 - 80 cm  
 - please specify exact width  
 Depending on model the door will be equipped with 1 tightening fitting  
 1 fitting set incl. mounting bracket  
 1 intermediate installation element with panel 12.6 cm above the through-door

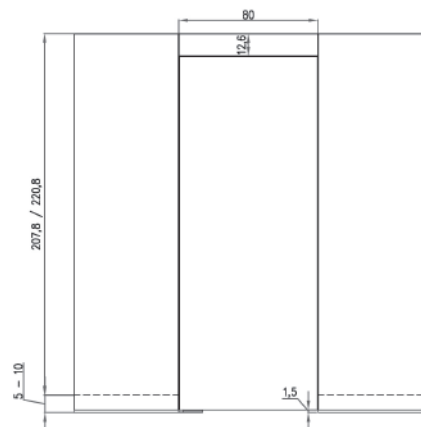


**GDTVP80 22 55**

R/L	1725	1964	2036	2941	3065	3131	3679	4047	-
-----	------	------	------	------	------	------	------	------	---

**Not available for:**  
 ALU TEC RP, ALUELEMENTS, ATLANTA-B, ATLANTA-S, BERGEN, CASTELLO, CHALET-B, CHALET-S, CHICAGO, FRAME, GARDA, INTARSIA, LUGANO, LUX-B, MIAMI, MODENA, MUNICH, NEVADA, NOBEL-B, NOBEL-S, ORLANDO-B, ORLANDO-S, OSLO 15, PADUA, SOFIE-B, SOFIE-S, TESSIN 15, TIM 15, TREND, VIÑO, VIVA, YORK-B, YORK-S




**The article comprises several packages and is supplied dismantled.**  
 Each front has a tightening fitting  
 Ranges without fitting: SMARTGLAS, NOBEL, SOFIE, YORK, LUGANO, TALEA, RIVA, GARDA, ATLANTA, ORLANDO, CHICAGO without tightening fitting  
**Planning advice:** only for planning between tall units







# Front filler 220.8 cm high



Carcase depth 55.5 cm (standard)

		Price groups													
		Order no.			Hinge side:	Carcase depth	1	2	3	4	5	6	7	8	9
		W	H	D											
 <p><b>Tall unit front filler</b> 220.8 cm high</p> <p>3.5 - 10 cm 10.1 - 20 cm</p>		<p><b>Note:</b> Models with horizontally running graining can only be supplied with 2-part front trim panel: Upper dimension: 142.6 cm Lower dimension: 77.6 cm</p>													
		<p><b>GP 10 22</b></p> <p><b>GP 20 22</b></p>													
 <p><b>Tall unit corner filler 90°</b> 220.8 cm high As corner connection between 2 tall units Without shelf, 9.5 x 9.5 cm</p>		<p><b>Note:</b> Models with horizontally running graining can only be supplied with 2-part front trim panel: Upper dimension: 142.6 cm Lower dimension: 77.6 cm</p>													
		<p><b>GPW 90 22</b></p>													
 <p><b>Tall unit corner filler 135°</b> 220.8 cm high For cladding blind corners Planning dimensions 25.9 x 25.9 cm</p>		<p><b>Not available for:</b> ALU TEC RP</p> <p><b>Note:</b> Models with horizontally running graining can only be supplied with 2-part front trim panel: Upper dimension: 142.6 cm Lower dimension: 77.6 cm</p>													
		<p><b>GPW 135 22</b></p>													



## Back cladding 220.8 cm high with screw-fitted fronts

 <p><b>Back cladding</b> For tall units, 220.8 cm high Carcase material with screw-fitted fronts, 142.6 cm and 77.6 cm Only available in grid sizes</p>		per 10 cm Width										
		<p><b>GVF 22 01</b></p> <p><b>Important!</b> Plinth panel is supplied loose.</p>										
 <p><b>Back cladding</b> For tall units, 220.8 cm high Carcase material with screw-fitted fronts 1 front 129.6 cm attached to 1 front 90.6 cm Only available in grid sizes</p>		per 10 cm Width										
		<p><b>GVF 22 03</b></p> <p><b>Important!</b> Plinth panel is supplied loose.</p>										

## Back cladding 220.8 cm high

		Order no.			Hinge side:	Carcase depth	Decor groups								
		W	H	D			M10	M20	M30	M40	M50	M60	M70	M80	M90
 <p><b>Back cladding</b> For tall units, 220.8 cm high 16 mm thick</p>		per 10 cm Width													
		<p><b>GVK 22</b></p>													
 <p><b>Tall unit background filler</b> Width: 20 cm For fitting flush with carcass 220.8 cm high</p>		Unit price													
		<p><b>GPSL 00 22</b></p>													
<b>M 10</b>	<b>M 20</b>	<b>M 30</b>			<b>M 40</b>			<b>M 50</b>							
K M10 laminate	D M20 Laminate decor	I M30 RESOPAL PRO super matt IH M30 HPL PRO PW M30 PRIMEWOOD/Basic Veneer			A M40 DIRECTLACK matt L M40 DIRECTLACK high-gloss			B M50 Velvet lacquer S M50 microstructure lacquer							
<b>M 60</b>	<b>M 70</b>	<b>M 80</b>			<b>M 90</b>										
QH M60 SMARTGLAS high-gloss QM M60 SMARTGLAS satin-finish	F M70 veneer / oak / walnut Z M70 Veneer / Bavaria	C1 M80 FENIX stainless-steel look H M80 high gloss-Lacquer MP M80 laqué mat Premium													




# Visible sides / increased side depth 220.8 cm high

		Decor groups										
		M10 M20 M30 M40 M50 M60 M70 M80 M90										
		Order no. W H D										
 <p><b>Tall unit visible side</b></p> <p>55.5 cm side depth Fixed dimension, not variable</p> <p>57.5 cm side depth Fixed dimension, not variable</p> <p>60.5 cm side depth Fixed dimension, not variable</p> <p>61 cm side depth Fixed dimension, not variable</p>	<p><b>Important!</b> Installation instead of a normal unit side. Only available in the listed side depths. For other dimensions, use GSVT...</p>	<b>GSV 22</b>	R/L	0	0	154	154	205	205	277	338	-
		<b>GSV 22 5</b>	R/L	0	0	154	154	205	205	277	338	-
		<b>GSV 22 6</b>	R/L	0	0	154	154	205	205	277	338	-
		<b>GSV 22 6 1</b>	R/L	0	0	154	154	205	205	277	338	-
 <p><b>Tall unit increased side depth</b></p> <p>from 61.1 cm up to 90 cm side depth</p> <p>Up to 60.9 cm side depth</p>	<p><b>Important!</b> Installation instead of a normal unit side.</p>	<b>GSVT 22</b>	R/L	92	123	334	334	445	445	604	666	-
		<b>GSVT 22 6</b>	R/L	46	58	225	225	299	299	403	492	-
<b>M 10</b>	<b>M 20</b>	<b>M 30</b>	<b>M 40</b>	<b>M 50</b>								
K M10 laminate	D M20 Laminate decor	I M30 RESOPAL PRO super matt IH M30 HPL PRO PW M30 PRIMEWOOD/Basic Veneer	A M40 DIRECTLACK matt L M40 DIRECTLACK high-gloss	B M50 Velvet lacquer P M50 Soft lacquer RH M50 Velvet lacquer wood texture RW M50 Velvet lacquer spackle effect S M50 microstructure lacquer								
<b>M 60</b>	<b>M 70</b>	<b>M 80</b>	<b>M 90</b>									
QH M60 SMARTGLAS high-gloss QM M60 SMARTGLAS satin-finish	F M70 veneer / oak / walnut V M70 Velvet lacquer textured Z M70 Veneer / Bavaria	C1 M80 FENIX stainless-steel look H M80 high gloss-Lacquer MP M80 laqué mat Premium O M80 Veneered										

# Shelf units 220.8 cm high

Carcase depth 57.7 cm, flush with front

■ = Models also available in 36.1/47.7/63.2 cm carcass depth  
(Order no.: replace ... 58 ... with 36/48/63)

		Decor groups											
		M10 M20 M30 M40 M50 M60 M70 M80 M90											
		Order no. W H D											
 <p><b>Tall shelf unit</b></p> <p>1 fixed shelf 4 adjustable shelves</p> <p>wide in cm: 13-30</p> <p>wide in cm: 30,1-40</p> <p>wide in cm: 40,1-45</p> <p>wide in cm: 45,1-50</p> <p>wide in cm: 50,1-60</p>		<b>GR 30 22 58</b>	■	402	-	-	-	1556	-	1556	1556	-	
		<b>GR 40 22 58</b>	■	402	-	-	-	1556	-	1556	1556	-	
		<b>GR 45 22 58</b>	■	402	-	-	-	1556	-	1556	1556	-	
		<b>GR 50 22 58</b>	■	402	-	-	-	1556	-	1556	1556	-	
		<b>GR 60 22 58</b>	■	402	-	-	-	1556	-	1556	1556	-	
 <p><b>Tall shelf end unit</b></p> <p>25 x 57.7 cm 5 fixed shelves For adjacent fitting left or right</p> <p>Ill. left</p>		<b>GRA 25 22 58</b>	R/L	■	453	-	-	-	1260	-	1260	1260	-
		<p><b>Important!</b> Only available in 25 cm width.</p>											
 <p><b>Tall shelf end unit</b></p> <p>34 x 57.7 cm 5 fixed shelves For adjacent fitting left or right</p> <p>Ill. left</p>		<b>GRA 34 22 58</b>	R/L	■	465	-	-	-	1472	-	1472	1472	-
<b>M 10</b>	<b>M 20</b>	<b>M 30</b>	<b>M 40</b>	<b>M 50</b>									
K M10 laminate				B M50 Velvet lacquer S M50 microstructure lacquer									
<b>M 60</b>	<b>M 70</b>	<b>M 80</b>	<b>M 90</b>										
	F M70 veneer / oak / walnut Z M70 Veneer / Bavaria	H M80 high gloss-Lacquer MP M80 laqué mat Premium											

# Raised dishwashers

For carcass height 220.8 cm, carcass depth 55.5 cm

Pull-out panel at bottom 25.6 cm high

**Note:**

Do not plan at the end of a row. Only plan between tall units.

Always follow the assembly instructions from the appliance manufacturers.

▲ = Types also available with 61 cm carcass depth (order no. ... replace ... 55 ... with 61)



Order no. W H D		Hinge side: R/L	Carcass depth	Price groups									
				1	2	3	4	5	6	7	8	9	
1166	<b>Dresser unit above raised dishwasher</b> Height 118.3 cm 1 door 116.6 cm 3 adjustable shelves 1 vapour protector	A	60 12 55	R/L ▲	352	369	396	494	561	597	655	721	-
646 516	<b>Dresser unit with lifting door for microwave above raised dishwasher</b> Height 118.3 cm 1 door 64.6 cm 1 lifting door with front 51.6 cm 2 adjustable shelves 1 vapour protector	ALT	60 12 55	R/L ▲	510	511	550	647	707	735	828	911	-
646	<b>Dresser unit for microwave above raised dishwasher</b> Height 118.3 cm 1 door 64.6 cm 1 panel 1 appliance aperture 35 - 45 cm 2 adjustable shelves 1 vapour protector		35,0-45,0										
				Not available for: ALU TEC RP, MIAMI, VIVA									
		AN	60 12 55 2	R/L ▲	352	369	396	494	561	597	655	721	-
		AN	60 12 55 2A	R/L ▲	352	369	396	494	561	597	655	721	-
776	<b>Base unit door, 77.6 cm</b> 59.6 cm wide As front panel for fully integrated dishwashers 86 cm high and pull-out fridges and freezers 59.6 cm wide with 60 cm				Always order article DL 60 6 if a high-volume dishwasher has not been included in planning!								
		UT	60 78 1		122	126	138	146	232	253	294	323	-
	<b>Spacer strips for fully integrated dishwasher</b> Appliance height 82 cm 2 spacer strips Colour: Art Pepper 6 cm high	DL	60 6		32								
256	<b>Base for raised dishwasher (86 cm high)</b> with top shelf, 15.5 cm high 1 drawer with pull-out panel 25.6 cm, 45.5 cm deep angled at top 1 collection tray (available only in 60 cm width)	UGS	60 10 55 87	▲	276	290	320	378	412	439	480	528	-
				Width 60 Not available for: ALU TEC RP									
				Important! Plan free-standing with 25 mm panels									
256	<b>Base for raised dishwasher (86 cm high)</b> only for dishwashers with VARIO HINGE with top shelf, 15.5 cm high 1 drawer with pull-out panel 25.6 cm not angled 45.5 cm deep 1 collection tray (available only in 60 cm width)	UGV	60 10 55 87	▲	276	290	320	378	412	439	480	528	-
				Important! Plan free-standing with 25 mm panels									

# Raised dishwashers

For carcass height 220.8 cm, carcass depth 55.5 cm

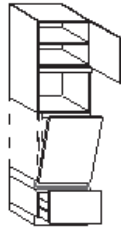
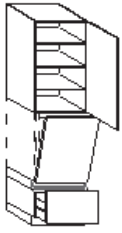
Pull-out panel at bottom 38.6 cm high

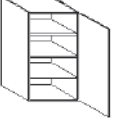
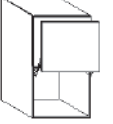
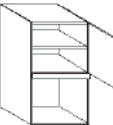
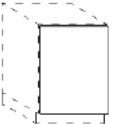

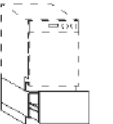
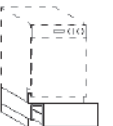

**Note:**

Do not plan at the end of a row. Only plan between tall units.

Always follow the assembly instructions from the appliance manufacturers.

▲ = Types also available with 61 cm carcass depth (order no. ... replace ... 55 ... with 61)



		Order no.			Hinge side:	Carcass depth	Price groups										
		W	H	D			1	2	3	4	5	6	7	8	9		
1036	 <p><b>Dresser unit above raised dishwasher</b> Height 105.3 cm 1 door 103.6 cm 3 adjustable shelves 1 vapour protector</p>	A	60	10	55	R/L ▲	317	331	354	441	502	532	586	645	-		
516	 <p><b>Dresser unit with lifting door for microwave above raised dishwasher</b> Height 105.3 cm 1 door 51.6 cm 1 lifting door with front 51.6 cm 1 adjustable shelf 1 vapour protector</p>	ALT	60	10	55	R/L ▲	471	498	510	596	646	672	759	835	-		
516	 <p><b>Dresser unit for microwave above raised dishwasher</b> Height 105.3 cm 1 door 51.6 cm 1 panel 1 appliance aperture 35 - 45 cm 1 adjustable shelf 1 vapour protector</p>	35,0-45,0															
<p>Not available for: ALU TEC RP, MIAMI, VIVA</p>																	
		AN	60	10	55	2	R/L ▲	317	331	354	441	502	532	586	645	-	
		AN	60	10	55	2A	R/L ▲	317	331	354	441	502	532	586	645	-	
776	 <p><b>Base unit door, 77.6 cm</b> 59.6 cm wide As front panel for fully integrated dishwashers 86 cm high and pull-out fridges and freezers 59.6 cm wide with 60 cm</p>						<p>Always order article DL 60 6 if a high-volume dishwasher has not been included in planning!</p>										
		UT	60	78	1			122	126	138	146	232	253	294	323	-	
	 <p><b>Spacer strips for fully integrated dishwasher</b> Appliance height 82 cm 2 spacer strips Colour: Art Pepper 6 cm high</p>	DL	60	6				32									
386	 <p><b>Base for raised dishwasher (86 cm high)</b> with top shelf, 28.5 cm high 1 pull-out 38.6 cm, 45.5 cm deep angled at top 1 collection tray (available only in 60 cm width)</p>	UGS	60	11	55	87	▲	285	298	326	389	419	445	485	534	-	
<p>Not available for: ALU TEC RP</p>																	
<p>Important! Plan free-standing with 25 mm panels</p>																	
386	 <p><b>Base for raised dishwasher (86 cm high)</b> only for dishwashers with <b>VARIO HINGE</b> with top shelf, 28.5 cm high 1 pull-out panel 38.6 cm, 45.5 cm deep not angled 1 collection tray (available only in 60 cm width)</p>	UGV	60	11	55	87	▲	285	298	326	389	419	445	485	534	-	
<p>Important! Plan free-standing with 25 mm panels</p>																	
	 <p><b>Vapour protector for raised dishwashers</b> Finish: metal to protect the fronts above</p>	WSB-45						11									
		WSB-60						12									

# Raised dishwashers

For carcass height 220.8 cm, carcass depth 55.5 cm

Pull-out panel at bottom 32.1 cm high

**Note:**

Do not plan at the end of a row. Only plan between tall units.

Always follow the assembly instructions from the appliance manufacturers.

▲ = Types also available with 61 cm carcass depth (order no. ... replace ... 55 ... with 61)



Order no. W H D		Hinge side: Carcase depth	Price groups										
			1	2	3	4	5	6	7	8	9		
581 516	<b>Dresser unit above raised dishwasher</b> Height 111.8 cm 1 door 58.1 cm 1 door 51.6 cm 2 adjustable shelves 1 vapour protector	A 60 11 55	R/L ▲	335	349	374	466	528	565	623	685	-	
			Not available for: MIAMI, VIVA										
581 516	<b>Dresser unit with lifting door for microwave above raised dishwasher</b> Height 111.8 cm 1 door 58.1 cm 1 lifting door with front 51.6 cm 1 adjustable shelf 1 vapour protector	ALT 60 11 55	R/L ▲	491	506	528	623	675	704	793	872	-	
			Not available for: MIAMI, VIVA										
581	<b>Dresser unit for microwave above raised dishwasher</b> Height 111.8 cm 1 door 58.1 cm 1 panel 1 appliance aperture 35 - 45 cm 1 adjustable shelf 1 vapour protector	35.0-45.0	Not available for: ALU TEC RP, MIAMI, VIVA										
			AN 60 11 55 2	R/L ▲	335	349	374	466	528	565	623	685	-
			AN 60 11 55 2A	R/L ▲	335	349	374	466	528	565	623	685	-
776	<b>Base unit door, 77.6 cm</b> 59.6 cm wide As front panel for fully integrated dishwashers 86 cm high and pull-out fridges and freezers 59.6 cm wide with 60 cm	Always order article DL 60 6 if a high-volume dishwasher has not been included in planning!											
		UT 60 78 1		122	126	138	146	232	253	294	323	-	
	<b>Spacer strips for fully integrated dishwasher</b> Appliance height 82 cm 2 spacer strips Colour: Art Pepper 6 cm high	DL 60 6		32									
321	<b>Base for raised dishwasher</b> with top shelf, 22.0 cm high 1 drawer with pull-out panel 32.1 cm, 45.5 cm deep, angled at top 1 collection tray (available only in 60 cm width)	UGS 60 15 55 871	▲	276	290	320	378	412	439	480	528	-	
			Not available for: ALU TEC RP, MIAMI, VIVA Important! Plan free-standing with 25 mm panels										
	<b>Base for raised dishwasher</b> only for dishwashers with VARIO HINGE with top shelf, 22.0 cm high 1 drawer with pull-out panel 32.1 cm, 45.5 cm deep, not chamfered 1 collection tray (available only in 60 cm width)	UGV 60 15 55 871	▲	276	290	320	378	412	439	480	528	-	
			Not available for: MIAMI, VIVA Important! Plan free-standing with 25 mm panels										

# Raised dishwashers

For carcass height 220.8 cm, carcass depth 55.5 cm

Pull-out panel at bottom 45.1 cm high

**Note:**

Do not plan at the end of a row. Only plan between tall units.

Always follow the assembly instructions from the appliance manufacturers.

▲ = Types also available with 61 cm carcass depth (order no. ... replace ... 55 ... with 61)



		Order no.	W	H	D	Hinge side:	Carcass depth	Price groups									
								1	2	3	4	5	6	7	8	9	
321 646	<p><b>Dresser unit above raised dishwasher</b>                      Height 98.8 cm                      1 flap door 32.1 cm                      1 door 64.6 cm                      2 adjustable shelves                      1 vapour protector</p>	<b>A</b>	<b>60</b>	<b>98</b>	<b>55</b>	R/L	▲	331	342	377	454	493	522	570	627	-	
581 386	<p><b>Dresser unit with lifting door for microwave above raised dishwasher</b>                      Height 98.8 cm                      1 door 58.1 cm                      1 lifting door with front 38.6 cm                      1 adjustable shelf                      1 vapour protector</p>	<b>ALT</b>	<b>60</b>	<b>98</b>	<b>55</b>	R/L	▲	479	506	524	601	626	647	731	804	-	
776	<p><b>Base unit door, 77.6 cm</b>                      59.6 cm wide                      As front panel for fully integrated dishwashers 86 cm high and pull-out fridges and freezers                      59.6 cm wide with 60 cm</p>							<i>Always order article DL 60 6 if a high-volume dishwasher has not been included in planning!</i>									
	<p><b>Spacer strips for fully integrated dishwasher</b>                      Appliance height 82 cm                      2 spacer strips                      Colour: Art Pepper 6 cm high</p>	<b>DL</b>	<b>60</b>	<b>6</b>				32									
451	<p><b>Base for raised dishwasher (86 cm high)</b>                      with top shelf, 35.0 cm high                      1 pull-out 45.1 cm, 45.5 cm deep angled at top                      1 collection tray (available only in 60 cm width)</p>		<b>UGS</b>	<b>60</b>	<b>12</b>	<b>55</b>	<b>87</b>	▲	295	306	337	401	431	459	500	550	-
								<b>Not available for:</b> ALU TEC RP									
								<b>Important!</b> Plan free-standing with 25 mm panels									
451	<p><b>Base for raised dishwasher (86 cm high)</b>                      only for dishwashers with <b>VARIO HINGE</b>                      with top shelf, 35.0 cm high                      1 pull-out panel 45.1 cm, 45.5 cm deep not angled                      1 collection tray (available only in 60 cm width)</p>		<b>UGV</b>	<b>60</b>	<b>12</b>	<b>55</b>	<b>87</b>	▲	295	306	337	401	431	459	500	550	-
								<b>Not available for:</b> ALU TEC RP									
								<b>Important!</b> Plan free-standing with 25 mm panels									

# 6.8

## Tall units 233.8 / 246.8 / 259.8 cm

Tall units 233.8 cm high	XL 6.8.2
Appliance unit 233.8 cm high for microwave / oven	XL 6.8.2-XL 6.8.4
Appliance unit 233.8 cm high for refrigerator/freezer	XL 6.8.4
Hochschränke 246,8 cm hoch	XL 6.8.6
Geräteschränke 246,8 cm hoch für Backofen/Mikrowelle	XL 6.8.6-XL 6.8.8
Geräteschränke 246,8 cm hoch für Kühl-/Gefrierschrank	XL 6.8.8
Hochschränke 259,8 cm hoch	XL 6.8.10
Geräteschränke 259,8 cm hoch für Backofen/Mikrowelle	XL 6.8.10-XL 6.8.12
Geräteschränke 259,8 cm hoch für Kühl-/Gefrierschrank	XL 6.8.12

### Legend:



Available with grip ledge N...



Not available with grip ledge N...



This symbol indicates which models are available



This symbol indicates which models are not available



wall-mounted units



available depths for wall-mounted units



Planning advice



This symbol illustrates which appliance units are delivered with integrated ventilation



Not available with „push-to-open“ fitting



Aperture height specifications



Available carcass depths 34/45.5/55.5/61.0 cm



Available carcass depths 45.5/55.5/61.0 cm

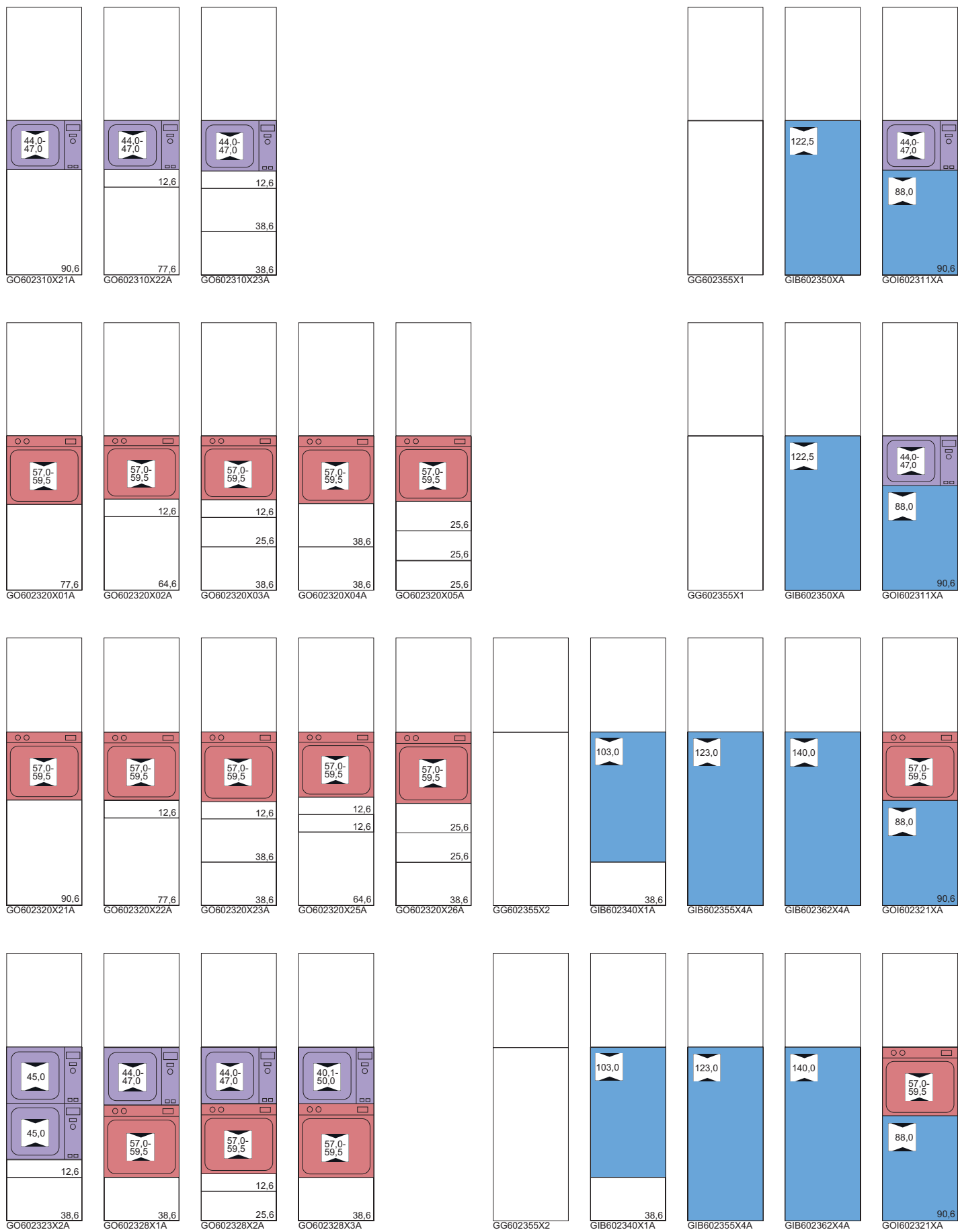


Available carcass depths 55.5/61.0 cm



Height  
233.8 / 246.8 /  
259.8 cm







# Recess overview Tall units 233.8 cm high



## Tall units 233.8 cm high

Carcase depth 55.5 cm (standard)






















▲ = Types also available with 61 cm carcass depth (order no. ... replace ... 55 ... with 61)

	Order no. W H D	Hinge side: R/L ▲	Carcass depth	Price groups								
				1	2	3	4	5	6	7	8	9
 <p><b>Crockery cupboard variable</b> 1 compensation door 1 variable door 136.0 - 141.1 cm 7 adjustable shelves 1 fixed shelf Article consists of Base and dresser unit, which means there will be joins on the side</p>	<b>GG 30 23 55 X1</b>	R/L ▲	703	741	838	952	1035	1082	1179	1297	-	
	<b>GG 40 23 55 X1</b>	R/L ▲	703	741	838	952	1035	1082	1179	1297	-	
	<b>GG 45 23 55 X1</b>	R/L ▲	703	741	838	952	1035	1082	1179	1297	-	
	<b>GG 50 23 55 X1</b>	R/L ▲	703	741	838	1001	1076	1127	1221	1343	-	
	<b>GG 60 23 55 X1</b>	R/L ▲	742	780	886	1096	1184	1236	1343	1477	-	
 <b>Width 30, 40, 45, 50, 60 Not available for: MIAMI, VIVA</b>												
 <i>If including side panels in the design, we recommend the front lines</i>												
 <p><b>Crockery cupboard variable</b> 1 compensation door 1 variable door 141.5 - 153.9 cm 7 adjustable shelves 1 fixed shelf Article consists of Base and dresser unit, which means there will be joins on the side</p>	<b>GG 30 23 55 X2</b>	R/L ▲	703	741	838	952	1035	1082	1179	1297	-	
	<b>GG 40 23 55 X2</b>	R/L ▲	703	741	838	952	1035	1082	1179	1297	-	
	<b>GG 45 23 55 X2</b>	R/L ▲	703	741	838	952	1035	1082	1179	1297	-	
	<b>GG 50 23 55 X2</b>	R/L ▲	703	741	838	1001	1076	1127	1221	1343	-	
	<b>GG 60 23 55 X2</b>	R/L ▲	742	780	886	1096	1184	1236	1343	1477	-	
 <b>Width 30, 40, 45, 50, 60 Not available for: CASTELLO, FRAME, MIAMI, MUNICH, NEVADA, VINO, VIVA</b>												
 <i>If including side panels in the design, we recommend the front lines</i>												

## Appliance unit 233.8 cm high for microwave / oven










Carcass depth 55.5 cm (standard)

▲ = Types also available with 61 cm carcass depth (order no. ... replace ... 55 ... with 61)

<p>906</p>  <p><b>Appliance unit</b> 1 compensation door 1 appliance aperture 44.0 - 47.0 cm 1 door 90.6 cm 6 adjustable shelves Article consists of Base and dresser unit, which means there will be joins on the side</p>	<p>44,0-47,0</p> <p>78</p>	<p><b>GO 60 23 55 10 X21A</b></p> <p> <b>Not available for: MIAMI, VIVA</b></p> <p> <i>If including side panels in the design, we recommend the front lines</i></p>	R/L ▲	782	820	928	1045	1115	1165	1262	1388	-
<p>126 776</p>  <p><b>Appliance unit</b> 1 compensation door 1 appliance aperture 44.0 - 47.0 cm 1 drawer 12.6 cm 1 door 77.6 cm 5 adjustable shelves Article consists of Base and dresser unit, which means there will be joins on the side</p>	<p>44,0-47,0</p> <p>78</p>	<p><b>GO 60 23 55 10 X22A</b></p> <p> <b>Not available for: MIAMI, VIVA</b></p> <p> <i>If including side panels in the design, we recommend the front lines</i></p>	R/L ▲	824	863	950	1043	1117	1176	1269	1396	-
<p>126 386 386</p>  <p><b>Appliance unit</b> 1 compensation door 3 adjustable shelves 1 appliance aperture 44.0 - 47.0 cm 1 drawer 12.6 cm 2 pull-outs 38.6 cm Article consists of Base and dresser unit, which means there will be joins on the side</p>	<p>44,0-47,0</p> <p>78</p>	<p><b>GO 60 23 55 10 X23A</b></p> <p> <b>Not available for: MIAMI, VIVA</b></p> <p> <i>If including side panels in the design, we recommend the front lines</i></p>	R/L ▲	1259	1300	1405	1522	1593	1641	1741	1915	-
<p>126 126 646</p>  <p><b>Appliance unit</b> 1 compensation door 1 appliance aperture 57.0 - 59.5 cm 2 drawers 12.6 cm 1 door 64.6 cm 5 adjustable shelves Article consists of Base and dresser unit, which means there will be joins on the side</p>	<p>57,0-59,5</p> <p>78</p>	<p><b>GO 60 23 55 20 X25A</b></p> <p> <b>Not available for: MIAMI, VIVA</b></p> <p> <i>If including side panels in the design, we recommend the front lines</i></p>	R/L ▲	872	897	956	1085	1171	1238	1335	1469	-
<p>256 256 386</p>  <p><b>Appliance unit</b> 1 compensation door 3 adjustable shelves 1 appliance aperture 57.0 - 59.5 cm 2 pull-outs 25.6 cm 1 pull-out 38.6 cm Article consists of Base and dresser unit, which means there will be joins on the side</p>	<p>57,0-59,5</p> <p>78</p>	<p><b>GO 60 23 55 20 X26A</b></p> <p> <b>Not available for: MIAMI, VIVA</b></p> <p> <i>If including side panels in the design, we recommend the front lines</i></p>	R/L ▲	1215	1242	1301	1418	1502	1571	1667	1834	-
<p>126 386 386</p>  <p><b>Appliance unit</b> 1 compensation door 3 adjustable shelves 1 appliance aperture 57.0 - 59.5 cm 1 drawer 12.6 cm 2 pull-outs 38.6 cm Article consists of Base and dresser unit, which means there will be joins on the side</p>	<p>57,0-59,5</p> <p>78</p>	<p><b>GO 60 23 55 20 X23A</b></p> <p> <b>Not available for: MIAMI, VIVA</b></p> <p> <i>If including side panels in the design, we recommend the front lines</i></p>	R/L ▲	1177	1201	1262	1390	1476	1543	1639	1803	-
<p>386 386</p>  <p><b>Appliance unit</b> 1 compensation door 3 adjustable shelves 1 appliance aperture 57.0 - 59.5 cm 2 pull-outs 38.6 cm Article consists of Base and dresser unit, which means there will be joins on the side</p>	<p>57,0-59,5</p> <p>78</p>	<p><b>GO 60 23 55 20 X04A</b></p> <p> <b>Not available for: MIAMI, VIVA</b></p> <p> <i>If including side panels in the design, we recommend the front lines</i></p>	R/L ▲	1068	1108	1194	1287	1361	1423	1514	1665	-

# Appliance unit 233.8 cm high for microwave / oven

Carcase depth 55.5 cm (standard)

		Price groups																	
		Hinge side:			Carcase depth														
		R/L			1	2	3	4	5	6	7	8	9						
<p>▲ = Types also available with 61 cm carcase depth (order no. ... replace ... 55 ... with 61)</p>		Order no.																	
		W H D																	
126 776	 <p><b>Appliance unit</b> 1 compensation door 1 appliance aperture 57.0 - 59.5 cm 1 drawer 12.6 cm 1 door 77.6 cm 5 adjustable shelves Article consists of Base and dresser unit, which means there will be joins on the side</p>	57,0- 59,5	GO	60	23	55	20	X22A	R/L	▲	784	810	870	1000	1084	1151	1249	1374	-
		78			<p>Not available for: MIAMI, VIVA</p> <p>If including side panels in the design, we recommend the front lines</p>														
256 256	 <p><b>Appliance unit</b> 1 compensation door 3 adjustable shelves 1 appliance aperture 57.0 - 59.5 cm 3 pull-outs 25.6 cm Article consists of Base and dresser unit, which means there will be joins on the side</p>	57,0- 59,5	GO	60	23	55	20	X05A	R/L	▲	1254	1294	1378	1471	1545	1606	1698	1868	-
		78			<p>Not available for: MIAMI, VIVA</p> <p>If including side panels in the design, we recommend the front lines</p>														
126 646	 <p><b>Appliance unit</b> 1 compensation door 1 appliance aperture 57.0 - 59.5 cm 1 drawer 12.6 cm 1 door 64.6 cm 5 adjustable shelves Article consists of Base and dresser unit, which means there will be joins on the side</p>	57,0- 59,5	GO	60	23	55	20	X02A	R/L	▲	824	863	950	1043	1117	1176	1269	1396	-
		78			<p>Not available for: MIAMI, VIVA</p> <p>If including side panels in the design, we recommend the front lines</p>														
776	 <p><b>Appliance unit</b> 1 compensation door 1 appliance aperture 57.0 - 59.5 cm 1 door 77.6 cm 5 adjustable shelves Article consists of Base and dresser unit, which means there will be joins on the side</p>	57,0- 59,5	GO	60	23	55	20	X01A	R/L	▲	738	775	863	956	1030	1089	1182	1300	-
		78			<p>Not available for: MIAMI, VIVA</p> <p>If including side panels in the design, we recommend the front lines</p>														
126 256 386	 <p><b>Appliance unit</b> 1 compensation door 2 adjustable shelves 1 appliance aperture 57.0 - 59.5 cm 1 drawer 12.6 cm 1 pull-out 25.6 cm 1 pull-out 38.6 cm Article consists of Base and dresser unit, which means there will be joins on the side</p>	57,0- 59,5	GO	60	23	55	20	X03A	R/L	▲	1214	1252	1340	1431	1504	1565	1657	1823	-
		78			<p>Not available for: MIAMI, VIVA</p> <p>If including side panels in the design, we recommend the front lines</p>														
906	 <p><b>Appliance unit</b> 1 compensation door 1 appliance aperture 57.0 - 59.5 cm 1 door 90.6 cm 6 adjustable shelves Article consists of Base and dresser unit, which means there will be joins on the side</p>	57,0- 59,5	GO	60	23	55	20	X21A	R/L	▲	699	722	783	913	997	1064	1162	1278	-
		78			<p>Not available for: MIAMI, VIVA</p> <p>If including side panels in the design, we recommend the front lines</p>														
386	 <p><b>Appliance unit</b> 1 compensation door 3 adjustable shelves 1 appliance aperture 44.0 - 47.0 cm 1 appliance aperture 57.0 - 59.5 cm 1 door 38.6 cm Article consists of Base and dresser unit, which means there will be joins on the side</p>	44,0- 47,0 57,0- 59,5	GO	60	23	55	28	X1A	R/L	▲	685	714	774	902	982	1052	1144	1258	-
		78			<p>Not available for: MIAMI, VIVA</p> <p>If including side panels in the design, we recommend the front lines</p>														
126 386	 <p><b>Appliance unit</b> 1 compensation door 3 adjustable shelves 1 appliance aperture 45.0 cm 1 appliance aperture 45.0 cm 1 drawer 12.6 cm 1 pull-out 38.6 cm Article consists of Base and dresser unit, which means there will be joins on the side</p>	45,0 45,0	GO	60	23	55	23	X2A	R/L	▲	976	1004	1065	1183	1267	1337	1427	1570	-
		78			<p>Not available for: MIAMI, VIVA</p> <p>If including side panels in the design, we recommend the front lines</p>														
126 256	 <p><b>Appliance unit</b> 1 compensation door 3 adjustable shelves 1 appliance aperture 44.0 - 47.0 cm 1 appliance aperture 57.0 - 59.5 cm 1 drawer 12.6 cm 1 pull-out 25.6 cm Article consists of Base and dresser unit, which means there will be joins on the side</p>	44,0- 47,0 57,0- 59,5	GO	60	23	55	28	X2A	R/L	▲	979	1008	1066	1196	1277	1347	1438	1582	-
		78			<p>Not available for: MIAMI, VIVA</p> <p>If including side panels in the design, we recommend the front lines</p>														




Models not available with compensation door: MIAMI, VIVA

# Appliance unit 233.8 cm high for microwave / oven

Carcase depth 55.5 cm (standard)







▲ = Types also available with 61 cm carcase depth (order no. ... replace ... 55 ... with 61)

	Order no. W H D	Hinge side: Carcase depth	Price groups								
			1	2	3	4	5	6	7	8	9
 <p><b>Appliance unit</b> 1 compensation door 3 adjustable shelves 1 appliance aperture 40.1 - 50,0 cm 1 integrated appliance aperture 58.0 - 59.5 cm 1 pull-out 38.6 cm Article consists of Base and dresser unit, which means there will be joins on the side</p>	<p>40,1-50,0</p> <p>58,0-59,5</p>	<p>GO 60 23 55 28 X3A R/L ▲</p> <p>Not available for: MIAMI, VIVA</p> <p>If including side panels in the design, we recommend the front lines</p>	832	864	922	1046	1129	1197	1287	1416	-

# Appliance unit 233.8 cm high for refrigerator/freezer

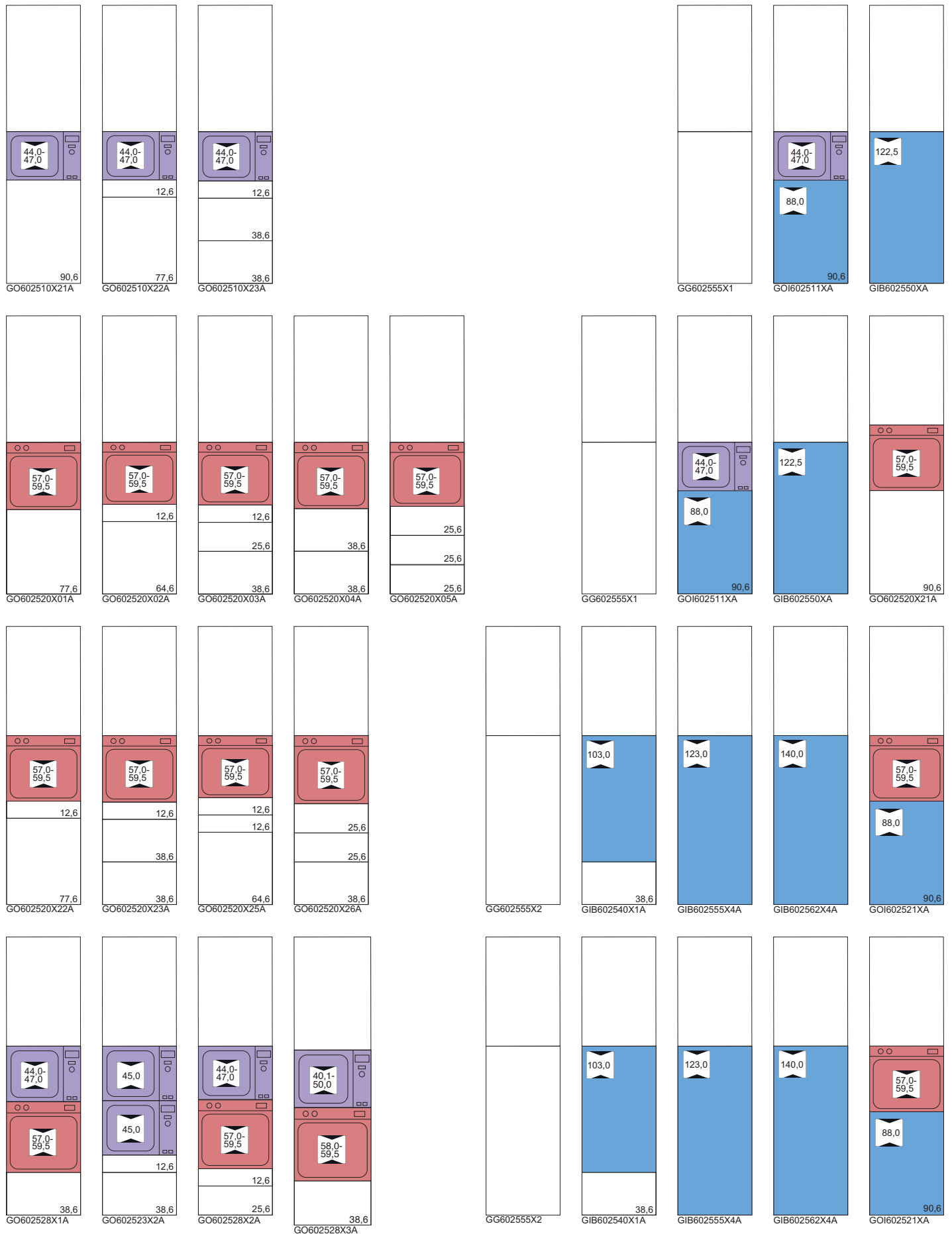
Carcase depth 55.5 cm (standard)

▲ = Types also available with 61 cm carcase depth (order no. ... replace ... 55 ... with 61) Integrated ventilation not possible with appliances with motor in the plinth (Cool Concept)

 <p><b>Appliance unit</b> 1 compensation door 3 adjustable shelves 1 appliance aperture 44.0 - 47.0 cm 1 integrated appliance aperture 88 cm 1 door 90.6 cm Article consists of Base and dresser unit, which means there will be joins on the side</p>	<p>44,0-47,0</p> <p>88,0</p>	<p>GOI 60 23 55 11 XA R/L ▲</p> <p>Not available for: MIAMI, VIVA</p> <p>If including side panels in the design, we recommend the front lines Important: Observe the appliance manufacturers' permitted front weights for fixed door assembly. See overview of models for front weights.</p>	782	820	928	1045	1115	1165	1262	1388	-
 <p><b>Appliance unit</b> 1 compensation door 3 adjustable shelves 1 appliance aperture 57.0 - 59.5 cm 1 integrated appliance aperture 88 cm 1 door 90.6 cm Article consists of Base and dresser unit, which means there will be joins on the side</p>	<p>57,0-59,5</p> <p>88,0</p>	<p>GOI 60 23 55 21 XA R/L ▲</p> <p>Not available for: MIAMI, VIVA</p> <p>If including side panels in the design, we recommend the front lines Important: Observe the appliance manufacturers' permitted front weights for fixed door assembly. See overview of models for front weights.</p>	699	722	783	913	997	1064	1162	1278	-
 <p><b>Appliance unit with integrated ventilation</b> 1 compensation door 3 adjustable shelves 1 integrated appliance aperture 103 cm 1 variable door 105.3 - 116.6 cm 1 pull-out 38.6 cm Article consists of Base and dresser unit, which means there will be joins on the side</p>	<p>103,0</p>	<p>GIB 60 23 55 40 X1A R/L ▲</p> <p>Not available for: MIAMI, VIVA</p> <p>If including side panels in the design, we recommend the front lines Important: Observe the appliance manufacturers' permitted front weights for fixed door assembly. See overview of models for front weights.</p>	919	947	1024	1182	1264	1322	1424	1566	-
 <p><b>Appliance unit with integrated ventilation</b> 1 compensation door 3 adjustable shelves 1 integrated appliance aperture 122.5 cm 1 variable door 131.9 - 142.6 cm Article consists of Base and dresser unit, which means there will be joins on the side</p>	<p>122,5</p>	<p>GIB 60 23 55 50 XA R/L ▲</p> <p>Not available for: MIAMI, VIVA</p> <p>If including side panels in the design, we recommend the front lines Important: Observe the appliance manufacturers' permitted front weights for fixed door assembly. See overview of models for front weights.</p>	815	862	983	1152	1275	1339	1453	1598	-
 <p><b>Appliance unit with integrated ventilation</b> 1 compensation door 3 adjustable shelves 1 integrated appliance aperture 140.0 cm 1 variable door 149.4 - 155.6 cm Article consists of Base and dresser unit, which means there will be joins on the side</p>	<p>140,0</p>	<p>GIB 60 23 55 62 X4A R/L ▲</p> <p>Not available for: CASTELLO, FRAME, MIAMI, MUNICH, NEVADA, VINO, VIVA</p> <p>If including side panels in the design, we recommend the front lines Important: Observe the appliance manufacturers' permitted front weights for fixed door assembly. See overview of models for front weights.</p>	849	880	956	1117	1197	1260	1360	1496	-
 <p><b>Appliance unit with integrated ventilation</b> 1 compensation door 3 adjustable shelves 1 integrated appliance aperture 123 cm 1 variable door 142.7 - 155.6 cm Article consists of Base and dresser unit, which means there will be joins on the side</p>	<p>123,0</p>	<p>GIB 60 23 55 55 X4A R/L ▲</p> <p>Not available for: CASTELLO, FRAME, MIAMI, MUNICH, NEVADA, VINO, VIVA</p> <p>If including side panels in the design, we recommend the front lines Important: Observe the appliance manufacturers' permitted front weights for fixed door assembly. See overview of models for front weights.</p>	770	796	875	1037	1117	1178	1277	1405	-









# Recess overview Tall units 246.8 cm high



# Tall units 246.8 cm high

Carcase depth 55.5 cm (standard)



















▲ = Types also available with 61 cm carcass depth (order no. ... replace ... 55 ... with 61)

	Order no. W H D	Hinge side: Carcass depth	Price groups								
			1	2	3	4	5	6	7	8	9
 <p><b>Crockery cupboard variable</b> 1 compensation door 1 variable door 136.0 - 141.1 cm 7 adjustable shelves 1 fixed shelf Article consists of Base and dresser unit, which means there will be joins on the side</p>	<b>GG 30 25 55 X1</b>	R/L ▲	772	819	936	1046	1133	1188	1286	1415	-
	<b>GG 40 25 55 X1</b>	R/L ▲	772	819	936	1046	1133	1188	1286	1415	-
	<b>GG 45 25 55 X1</b>	R/L ▲	772	819	936	1046	1133	1188	1286	1415	-
	<b>GG 50 25 55 X1</b>	R/L ▲	772	819	936	1095	1174	1233	1328	1461	-
	<b>GG 60 25 55 X1</b>	R/L ▲	811	859	984	1190	1283	1342	1450	1595	-
 <p>Width 30, 40, 45, 50, 60 Not available for: MIAMI, VIVA</p>											
 <p>If including side panels in the design, we recommend the front lines</p>											
 <p><b>Crockery cupboard variable</b> 1 compensation door 1 variable door 141.5 - 153.9 cm 7 adjustable shelves 1 fixed shelf Article consists of Base and dresser unit, which means there will be joins on the side</p>	<b>GG 30 25 55 X2</b>	R/L ▲	772	819	936	1046	1133	1188	1286	1415	-
	<b>GG 40 25 55 X2</b>	R/L ▲	772	819	936	1046	1133	1188	1286	1415	-
	<b>GG 45 25 55 X2</b>	R/L ▲	772	819	936	1046	1133	1188	1286	1415	-
	<b>GG 50 25 55 X2</b>	R/L ▲	772	819	936	1095	1174	1233	1328	1461	-
	<b>GG 60 25 55 X2</b>	R/L ▲	811	859	984	1190	1283	1342	1450	1595	-
 <p>Width 30, 40, 45, 50, 60 Not available for: CASTELLO, FRAME, MIAMI, MUNICH, NEVADA, VINO, VIVA</p>											
 <p>If including side panels in the design, we recommend the front lines</p>											

## Appliance unit 246.8 cm high for microwave / oven

Carcass depth 55.5 cm (standard)



















▲ = Types also available with 61 cm carcass depth (order no. ... replace ... 55 ... with 61)

<p>906</p>  <p><b>Appliance unit</b> 1 compensation door 1 appliance aperture 44.0 - 47.0 cm 1 door 90.6 cm 6 adjustable shelves Article consists of Base and dresser unit, which means there will be joins on the side</p>	<p>44,0-47,0</p> <p><b>GO 60 25 55 10 X21A</b></p> <p>R/L ▲</p> <p>851 899 1025 1140 1214 1271 1370 1507 -</p> <p> Not available for: MIAMI, VIVA</p> <p> If including side panels in the design, we recommend the front lines</p>
<p>126 776</p>  <p><b>Appliance unit</b> 1 compensation door 1 appliance aperture 44.0 - 47.0 cm 1 drawer 12.6 cm 1 door 77.6 cm 5 adjustable shelves Article consists of Base and dresser unit, which means there will be joins on the side</p>	<p>44,0-47,0</p> <p><b>GO 60 25 55 10 X22A</b></p> <p>R/L ▲</p> <p>893 941 1047 1137 1216 1282 1376 1514 -</p> <p><b>78</b></p> <p> Not available for: MIAMI, VIVA</p> <p> If including side panels in the design, we recommend the front lines</p>
<p>126 386 386</p>  <p><b>Appliance unit</b> 1 compensation door 3 adjustable shelves 1 appliance aperture 44.0 - 47.0 cm 1 drawer 12.6 cm 2 pull-outs 38.6 cm Article consists of Base and dresser unit, which means there will be joins on the side</p>	<p>44,0-47,0</p> <p><b>GO 60 25 55 10 X23A</b></p> <p>R/L ▲</p> <p>1328 1378 1502 1617 1692 1747 1848 2033 -</p> <p><b>78</b></p> <p> Not available for: MIAMI, VIVA</p> <p> If including side panels in the design, we recommend the front lines</p>
<p>126 126 646</p>  <p><b>Appliance unit</b> 1 compensation door 1 appliance aperture 57.0 - 59.5 cm 2 drawers 12.6 cm 1 door 64.6 cm 5 adjustable shelves Article consists of Base and dresser unit, which means there will be joins on the side</p>	<p>57,0-59,5</p> <p><b>GO 60 25 55 20 X25A</b></p> <p>R/L ▲</p> <p>912 950 1036 1129 1204 1262 1355 1491 -</p> <p><b>78</b></p> <p> Not available for: MIAMI, VIVA</p> <p> If including side panels in the design, we recommend the front lines</p>
<p>126 776</p>  <p><b>Appliance unit</b> 1 compensation door 1 appliance aperture 57.0 - 59.5 cm 1 drawer 12.6 cm 1 door 77.6 cm 5 adjustable shelves Article consists of Base and dresser unit, which means there will be joins on the side</p>	<p>57,0-59,5</p> <p><b>GO 60 25 55 20 X22A</b></p> <p>R/L ▲</p> <p>824 863 950 1043 1117 1176 1269 1396 -</p> <p><b>78</b></p> <p> Not available for: MIAMI, VIVA</p> <p> If including side panels in the design, we recommend the front lines</p>
<p>126 386 386</p>  <p><b>Appliance unit</b> 1 compensation door 3 adjustable shelves 1 appliance aperture 57.0 - 59.5 cm 1 drawer 12.6 cm 2 pull-outs 38.6 cm Article consists of Base and dresser unit, which means there will be joins on the side</p>	<p>57,0-59,5</p> <p><b>GO 60 25 55 20 X23A</b></p> <p>R/L ▲</p> <p>1216 1254 1342 1433 1508 1568 1659 1825 -</p> <p><b>78</b></p> <p> Not available for: MIAMI, VIVA</p> <p> If including side panels in the design, we recommend the front lines</p>



# Appliance unit 246.8 cm high for microwave / oven

Carcase depth 55.5 cm (standard)

						Price groups								
		Order no.		Hinge side:	Carcase depth	1	2	3	4	5	6	7	8	9
		W H D												
906		<b>Appliance unit</b> 1 compensation door 1 appliance aperture 57.0 - 59.5 cm 1 door 90.6 cm 6 adjustable shelves Article consists of Base and dresser unit, which means there will be joins on the side	57,0-59,5	<b>GO 60 25 55 20 X21A</b>	R/L ▲	738	775	863	956	1030	1089	1182	1300	-
				<b>Not available for:</b> MIAMI, VIVA										
				 If including side panels in the design, we recommend the front lines										
256 256 386		<b>Appliance unit</b> 1 compensation door 3 adjustable shelves 1 appliance aperture 57.0 - 59.5 cm 2 pull-outs 25.6 cm 1 pull-out 38.6 cm Article consists of Base and dresser unit, which means there will be joins on the side	57,0-59,5	<b>GO 60 25 55 20 X26A</b>	R/L ▲	1254	1295	1380	1462	1535	1595	1688	1857	-
				<b>Not available for:</b> MIAMI, VIVA										
				 If including side panels in the design, we recommend the front lines										
126 646		<b>Appliance unit</b> 1 compensation door 1 appliance aperture 57.0 - 59.5 cm 1 drawer 12.6 cm 1 door 64.6 cm 5 adjustable shelves Article consists of Base and dresser unit, which means there will be joins on the side	57,0-59,5 <b>78</b>	<b>GO 60 25 55 20 X02A</b>	R/L ▲	893	941	1047	1137	1216	1282	1376	1514	-
				<b>Not available for:</b> MIAMI, VIVA										
				 If including side panels in the design, we recommend the front lines										
256 256 256		<b>Appliance unit</b> 1 compensation door 3 adjustable shelves 1 appliance aperture 57.0 - 59.5 cm 3 pull-outs 25.6 cm Article consists of Base and dresser unit, which means there will be joins on the side	57,0-59,5 <b>78</b>	<b>GO 60 25 55 20 X05A</b>	R/L ▲	1323	1373	1476	1566	1644	1712	1805	1986	-
				<b>Not available for:</b> MIAMI, VIVA										
				 If including side panels in the design, we recommend the front lines										
776		<b>Appliance unit</b> 1 compensation door 1 appliance aperture 57.0 - 59.5 cm 1 door 77.6 cm 5 adjustable shelves Article consists of Base and dresser unit, which means there will be joins on the side	57,0-59,5 <b>78</b>	<b>GO 60 25 55 20 X01A</b>	R/L ▲	807	853	960	1050	1129	1195	1289	1418	-
				<b>Not available for:</b> MIAMI, VIVA										
				 If including side panels in the design, we recommend the front lines										
126 256 386		<b>Appliance unit</b> 1 compensation door 3 adjustable shelves 1 appliance aperture 57.0 - 59.5 cm 1 drawer 12.6 cm 1 pull-out 25.6 cm 1 pull-out 38.6 cm Article consists of Base and dresser unit, which means there will be joins on the side	57,0-59,5 <b>78</b>	<b>GO 60 25 55 20 X03A</b>	R/L ▲	1283	1330	1437	1525	1603	1671	1764	1940	-
				<b>Not available for:</b> MIAMI, VIVA										
				 If including side panels in the design, we recommend the front lines										
386 386		<b>Appliance unit</b> 1 compensation door 3 adjustable shelves 1 appliance aperture 57.0 - 59.5 cm 2 pull-outs 38.6 cm Article consists of Base and dresser unit, which means there will be joins on the side	57,0-59,5 <b>78</b>	<b>GO 60 25 55 20 X04A</b>	R/L ▲	1137	1186	1291	1381	1460	1529	1621	1783	-
				<b>Not available for:</b> MIAMI, VIVA										
				 If including side panels in the design, we recommend the front lines										
386		<b>Appliance unit</b> 1 compensation door 3 adjustable shelves 1 appliance aperture 40.1 - 50,0 cm 1 appliance aperture 58.0 - 59.5 cm 1 pull-out 38.6 cm Article consists of Base and dresser unit, which means there will be joins on the side	40,1-50,0 58,0-59,5	<b>GO 60 25 55 28 X3A</b>	R/L ▲	871	917	1002	1090	1162	1221	1307	1438	-
				<b>Not available for:</b> MIAMI, VIVA										
				 If including side panels in the design, we recommend the front lines										
386		<b>Appliance unit</b> 1 compensation door 3 adjustable shelves 1 appliance aperture 44.0 - 47.0 cm 1 appliance aperture 57.0 - 59.5 cm 1 door 38.6 cm Article consists of Base and dresser unit, which means there will be joins on the side	44,0-47,0 57,0-59,5	<b>GO 60 25 55 28 X1A</b>	R/L ▲	724	767	853	946	1014	1076	1164	1280	-
				<b>Not available for:</b> MIAMI, VIVA										
				 If including side panels in the design, we recommend the front lines										

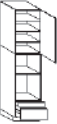



Models not available with compensation door: MIAMI, VIVA

# Appliance unit 246.8 cm high for microwave / oven

Carcase depth 55.5 cm (standard)



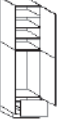



▲ = Types also available with 61 cm carcase depth (order no. ... replace ... 55 ... with 61)

		Order no.		Hinge side:		Price groups									
		W H D		Carcase depth		1	2	3	4	5	6	7	8	9	
126 256		<b>Appliance unit</b>		44,0-47,0	R/L ▲	GO 60 25 55 28 X2A	1019	1061	1146	1239	1310	1372	1459	1605	-
		1 compensation door 3 adjustable shelves 1 appliance aperture 44.0 - 47.0 cm 1 appliance aperture 57.0 - 59.5 cm 1 drawer 12.6 cm 1 pull-out 25.6 cm Article consists of Base and dresser unit, which means there will be joins on the side				Not available for: MIAMI, VIVA If including side panels in the design, we recommend the front lines									
126 386		<b>Appliance unit</b>		45,0	R/L ▲	GO 60 25 55 23 X2A	1015	1057	1145	1226	1300	1361	1447	1592	-
		1 compensation door 3 adjustable shelves 1 appliance aperture 45.0 cm 1 appliance aperture 45.0 cm 1 drawer 12.6 cm 1 pull-out 38.6 cm Article consists of Base and dresser unit, which means there will be joins on the side				Not available for: MIAMI, VIVA If including side panels in the design, we recommend the front lines									

# Appliance unit 246.8 cm high for refrigerator/freezer

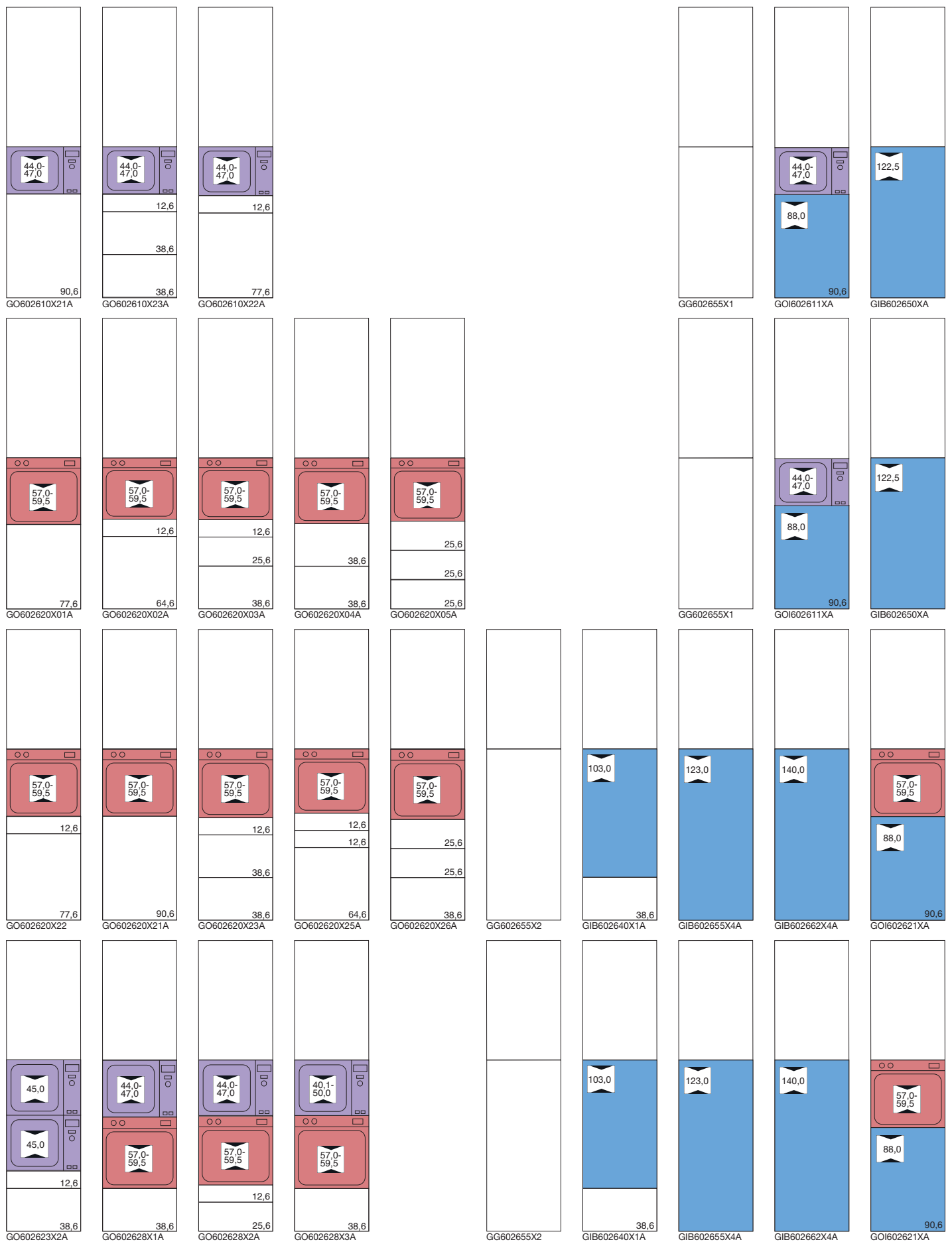
Carcase depth 55.5 cm (standard)

▲ = Types also available with 61 cm carcase depth (order no. ... replace ... 55 ... with 61) Integrated ventilation not possible with appliances with motor in the plinth (Cool Concept)

906		<b>Appliance unit</b>		44,0-47,0	R/L ▲	GOI 60 25 55 11 XA	851	899	1025	1140	1214	1271	1370	1507	-
		1 compensation door 3 adjustable shelves 1 appliance aperture 44.0 - 47.0 cm 1 integrated appliance aperture 88 cm 1 door 90.6 cm Article consists of Base and dresser unit, which means there will be joins on the side				Not available for: MIAMI, VIVA If including side panels in the design, we recommend the front lines Important: Observe the appliance manufacturers' permitted front weights for fixed door assembly. See overview of models for front weights.									
906		<b>Appliance unit</b>		57,0-59,5	R/L ▲	GOI 60 25 55 21 XA	738	775	863	956	1030	1089	1182	1300	-
		1 compensation door 3 adjustable shelves 1 appliance aperture 57.0 - 59.5 cm 1 integrated appliance aperture 88 cm 1 door 90.6 cm Article consists of Base and dresser unit, which means there will be joins on the side				Not available for: MIAMI, VIVA If including side panels in the design, we recommend the front lines Important: Observe the appliance manufacturers' permitted front weights for fixed door assembly. See overview of models for front weights.									
386		<b>Appliance unit with integrated ventilation</b>		103,0	R/L ▲	GIB 60 25 55 40 X1A	958	1000	1103	1225	1296	1346	1444	1588	-
		1 compensation door 3 adjustable shelves 1 integrated appliance aperture 103 cm 1 variable door 105.3 - 116.6 cm 1 pull-out 38.6 cm Article consists of Base and dresser unit, which means there will be joins on the side				Not available for: MIAMI, VIVA If including side panels in the design, we recommend the front lines Important: Observe the appliance manufacturers' permitted front weights for fixed door assembly. See overview of models for front weights.									
		<b>Appliance unit with integrated ventilation</b>		122,5	R/L ▲	GIB 60 25 55 50 XA	884	940	1080	1247	1374	1445	1560	1716	-
		1 compensation door 3 adjustable shelves 1 integrated appliance aperture 122.5 cm 1 variable door 131.9 - 142.6 cm Article consists of Base and dresser unit, which means there will be joins on the side				Not available for: MIAMI, VIVA If including side panels in the design, we recommend the front lines Important: Observe the appliance manufacturers' permitted front weights for fixed door assembly. See overview of models for front weights.									
		<b>Appliance unit with integrated ventilation</b>		140,0	R/L ▲	GIB 60 25 55 62 X4A	888	933	1036	1161	1230	1285	1380	1518	-
		1 compensation door 3 adjustable shelves 1 integrated appliance aperture 140.0 cm 1 variable door 149.4 - 155.6 cm Article consists of Base and dresser unit, which means there will be joins on the side				Not available for: CASTELLO, FRAME, MIAMI, MUNICH, NEVADA, VINO, VIVA If including side panels in the design, we recommend the front lines Important: Observe the appliance manufacturers' permitted front weights for fixed door assembly. See overview of models for front weights.									
		<b>Appliance unit with integrated ventilation</b>		123,0	R/L ▲	GIB 60 25 55 55 X4A	809	849	954	1080	1150	1202	1297	1427	-
		1 compensation door 3 adjustable shelves 1 integrated appliance aperture 123 cm 1 variable door 142.7 - 155.6 cm Article consists of Base and dresser unit, which means there will be joins on the side				Not available for: CASTELLO, FRAME, MIAMI, MUNICH, NEVADA, VINO, VIVA If including side panels in the design, we recommend the front lines Important: Observe the appliance manufacturers' permitted front weights for fixed door assembly. See overview of models for front weights.									









# Recess overview Tall units 259.8 cm high



## Tall units 259.8 cm high

Carcase depth 55.5 cm (standard)



















▲ = Types also available with 61 cm carcass depth (order no. ... replace ... 55 ... with 61)

	Order no. W H D	Hinge side: Carcass depth	Price groups								
			1	2	3	4	5	6	7	8	9
 <p><b>Crockery cupboard variable</b> 1 compensation door 1 variable door 136.0 - 141.1 cm 8 adjustable shelves 1 fixed shelf Article consists of Base and dresser unit, which means there will be joins on the side</p>	<b>GG 30 26 55 X1</b>	R/L ▲	777	836	957	1070	1160	1216	1314	1445	-
	<b>GG 40 26 55 X1</b>	R/L ▲	777	836	957	1070	1160	1216	1314	1445	-
	<b>GG 45 26 55 X1</b>	R/L ▲	777	836	957	1070	1160	1216	1314	1445	-
	<b>GG 50 26 55 X1</b>	R/L ▲	777	836	957	1118	1201	1260	1357	1493	-
	<b>GG 60 26 55 X1</b>	R/L ▲	816	876	1005	1214	1309	1370	1479	1627	-
 <b>Width 30, 40, 45, 50, 60 Not available for: MIAMI, VIVA</b>											
 <i>If including side panels in the design, we recommend the front lines</i>											
 <p><b>Crockery cupboard variable</b> 1 compensation door 1 variable door 141.5 - 153.9 cm 7 adjustable shelves 1 fixed shelf Article consists of Base and dresser unit, which means there will be joins on the side</p>	<b>GG 30 26 55 X2</b>	R/L ▲	777	836	957	1070	1160	1216	1314	1445	-
	<b>GG 40 26 55 X2</b>	R/L ▲	777	836	957	1070	1160	1216	1314	1445	-
	<b>GG 45 26 55 X2</b>	R/L ▲	777	836	957	1070	1160	1216	1314	1445	-
	<b>GG 50 26 55 X2</b>	R/L ▲	777	836	957	1118	1201	1260	1357	1493	-
	<b>GG 60 26 55 X2</b>	R/L ▲	816	876	1005	1214	1309	1370	1479	1627	-
 <b>Width 30, 40, 45, 50, 60 Not available for: CASTELLO, FRAME, MIAMI, MUNICH, NEVADA, VINO, VIVA</b>											
 <i>If including side panels in the design, we recommend the front lines</i>											

## Appliance unit 259.8 cm high for microwave / oven










Carcass depth 55.5 cm (standard)

▲ = Types also available with 61 cm carcass depth (order no. ... replace ... 55 ... with 61)

	Order no. W H D	Hinge side: Carcass depth	Price groups									
			1	2	3	4	5	6	7	8	9	
 <p><b>Appliance unit</b> 1 compensation door 1 appliance aperture 44.0 - 47.0 cm 1 door 90.6 cm 7 adjustable shelves Article consists of Base and dresser unit, which means there will be joins on the side</p>	<b>44,0-47,0</b>	R/L ▲	<b>GO 60 26 55 10 X21A</b>	856	916	1046	1163	1240	1299	1398	1538	-
	 <b>Not available for: MIAMI, VIVA</b>											
 <i>If including side panels in the design, we recommend the front lines</i>												
 <p><b>Appliance unit</b> 1 compensation door 1 appliance aperture 44.0 - 47.0 cm 1 drawer 12.6 cm 1 door 77.6 cm 6 adjustable shelves Article consists of Base and dresser unit, which means there will be joins on the side</p>	<b>44,0-47,0</b>	R/L ▲	<b>GO 60 26 55 10 X22A</b>	898	958	1068	1161	1242	1309	1405	1546	-
	<b>78</b>		 <b>Not available for: MIAMI, VIVA</b>									
 <i>If including side panels in the design, we recommend the front lines</i>												
 <p><b>Appliance unit</b> 1 compensation door 4 adjustable shelves 1 appliance aperture 44.0 - 47.0 cm 1 drawer 12.6 cm 2 pull-outs 38.6 cm Article consists of Base and dresser unit, which means there will be joins on the side</p>	<b>44,0-47,0</b>	R/L ▲	<b>GO 60 26 55 10 X23A</b>	1333	1395	1523	1640	1718	1774	1876	2064	-
	<b>78</b>		 <b>Not available for: MIAMI, VIVA</b>									
 <i>If including side panels in the design, we recommend the front lines</i>												
 <p><b>Appliance unit</b> 1 compensation door 3 adjustable shelves 1 appliance aperture 45.0 cm 1 appliance aperture 45.0 cm 1 drawer 12.6 cm 1 pull-out 38.6 cm Article consists of Base and dresser unit, which means there will be joins on the side</p>	<b>45,0</b>	R/L ▲	<b>GO 60 26 55 23 X2A</b>	1084	1135	1242	1321	1398	1467	1554	1709	-
	<b>45,0</b>		 <b>Not available for: MIAMI, VIVA</b>									
 <i>If including side panels in the design, we recommend the front lines</i>												
 <p><b>Appliance unit</b> 1 compensation door 3 adjustable shelves 1 appliance aperture 44.0 - 47.0 cm 1 appliance aperture 57.0 - 59.5 cm 1 door 38.6 cm Article consists of Base and dresser unit, which means there will be joins on the side</p>	<b>44,0-47,0</b>	R/L ▲	<b>GO 60 26 55 28 X1A</b>	793	846	951	1040	1113	1182	1271	1398	-
	<b>57,0-59,5</b>		 <b>Not available for: MIAMI, VIVA</b>									
 <i>If including side panels in the design, we recommend the front lines</i>												
 <p><b>Appliance unit</b> 1 compensation door 3 adjustable shelves 1 appliance aperture 44.0 - 47.0 cm 1 appliance aperture 57.0 - 59.5 cm 1 drawer 12.6 cm 1 pull-out 25.6 cm Article consists of Base and dresser unit, which means there will be joins on the side</p>	<b>44,0-47,0</b>	R/L ▲	<b>GO 60 26 55 28 X2A</b>	1088	1140	1243	1333	1409	1478	1566	1723	-
	<b>57,0-59,5</b>		 <b>Not available for: MIAMI, VIVA</b>									
 <i>If including side panels in the design, we recommend the front lines</i>												

# Appliance unit 259.8 cm high for microwave / oven

Carcase depth 55.5 cm (standard)

						Price groups									
		Order no.		Hinge side:	Carcase depth	1	2	3	4	5	6	7	8	9	
		W H D													
126 776		<b>Appliance unit</b> 1 compensation door 1 appliance aperture 57.0 - 59.5 cm 1 drawer 12.6 cm 1 door 77.6 cm 5 adjustable shelves Article consists of Base and dresser unit, which means there will be joins on the side	57.0- 59.5	<b>GO 60 26 55 20 X22A</b>	R/L ▲	893	941	1047	1137	1216	1282	1376	1514	-	
				78	Not available for: MIAMI, VIVA If including side panels in the design, we recommend the front lines										
256 256 386		<b>Appliance unit</b> 1 compensation door 3 adjustable shelves 1 appliance aperture 57.0 - 59.5 cm 2 pull-outs 25.6 cm 1 pull-out 38.6 cm Article consists of Base and dresser unit, which means there will be joins on the side	57.0- 59.5	<b>GO 60 26 55 20 X26A</b>	R/L ▲	1323	1374	1478	1556	1633	1701	1795	1975	-	
				78	Not available for: MIAMI, VIVA If including side panels in the design, we recommend the front lines										
906		<b>Appliance unit</b> 1 compensation door 1 appliance aperture 57.0 - 59.5 cm 1 door 90.6 cm 6 adjustable shelves Article consists of Base and dresser unit, which means there will be joins on the side	57.0- 59.5	<b>GO 60 26 55 20 X21A</b>	R/L ▲	807	853	960	1050	1129	1195	1289	1418	-	
				78	Not available for: MIAMI, VIVA If including side panels in the design, we recommend the front lines										
776		<b>Appliance unit</b> 1 compensation door 1 appliance aperture 57.0 - 59.5 cm 1 door 77.6 cm 6 adjustable shelves Article consists of Base and dresser unit, which means there will be joins on the side	57.0- 59.5	<b>GO 60 26 55 20 X01A</b>	R/L ▲	812	870	982	1074	1155	1222	1318	1450	-	
				78	Not available for: MIAMI, VIVA If including side panels in the design, we recommend the front lines										
256 256 256		<b>Appliance unit</b> 1 compensation door 4 adjustable shelves 1 appliance aperture 57.0 - 59.5 cm 3 pull-outs 25.6 cm Article consists of Base and dresser unit, which means there will be joins on the side	57.0- 59.5	<b>GO 60 26 55 20 X05A</b>	R/L ▲	1328	1390	1497	1589	1671	1739	1834	2017	-	
				78	Not available for: MIAMI, VIVA If including side panels in the design, we recommend the front lines										
386 386		<b>Appliance unit</b> 1 compensation door 4 adjustable shelves 1 appliance aperture 57.0 - 59.5 cm 2 pull-outs 38.6 cm Article consists of Base and dresser unit, which means there will be joins on the side	57.0- 59.5	<b>GO 60 26 55 20 X04A</b>	R/L ▲	1143	1203	1312	1405	1486	1556	1649	1814	-	
				78	Not available for: MIAMI, VIVA If including side panels in the design, we recommend the front lines										
126 646		<b>Appliance unit</b> 1 compensation door 1 appliance aperture 57.0 - 59.5 cm 1 drawer 12.6 cm 1 door 64.6 cm 5 adjustable shelves Article consists of Base and dresser unit, which means there will be joins on the side	57.0- 59.5	<b>GO 60 26 55 20 X02A</b>	R/L ▲	898	958	1068	1161	1242	1309	1405	1546	-	
				78	Not available for: MIAMI, VIVA If including side panels in the design, we recommend the front lines										
126 126 646		<b>Appliance unit</b> 1 compensation door 1 appliance aperture 57.0 - 59.5 cm 2 drawers 12.6 cm 1 door 64.6 cm 5 adjustable shelves Article consists of Base and dresser unit, which means there will be joins on the side	57.0- 59.5	<b>GO 60 26 55 20 X25A</b>	R/L ▲	981	1028	1133	1223	1303	1368	1462	1608	-	
				78	Not available for: MIAMI, VIVA If including side panels in the design, we recommend the front lines										
126 256 386		<b>Appliance unit</b> 1 compensation door 3 adjustable shelves 1 appliance aperture 57.0 - 59.5 cm 1 drawer 12.6 cm 1 pull-out 25.6 cm 1 pull-out 38.6 cm Article consists of Base and dresser unit, which means there will be joins on the side	57.0- 59.5	<b>GO 60 26 55 20 X03A</b>	R/L ▲	1288	1347	1459	1549	1629	1698	1792	1971	-	
				78	Not available for: MIAMI, VIVA If including side panels in the design, we recommend the front lines										




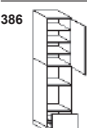
Models not available with compensation door: MIAMI, VIVA



# Appliance unit 259.8 cm high for microwave / oven

Carcase depth 55.5 cm (standard)



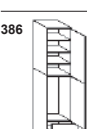

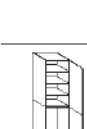

▲ = Types also available with 61 cm carcass depth (order no. ... replace ... 55 ... with 61)

		Order no.		Hinge side:	Carcass depth	Price groups													
		W	H	D			1	2	3	4	5	6	7	8	9				
	<b>Appliance unit</b> 1 compensation door 3 adjustable shelves 1 appliance aperture 57.0 - 59.5 cm 1 drawer 12.6 cm 2 pull-outs 38.6 cm Article consists of Base and dresser unit, which means there will be joins on the side	57,0-59,5	GO	60	26	55	20	X23A	R/L	▲	1285	1332	1439	1527	1607	1674	1766	1943	-
		78	Not available for: MIAMI, VIVA If including side panels in the design, we recommend the front lines																
	<b>Appliance unit</b> 1 compensation door 3 adjustable shelves 1 appliance aperture 40.1 - 50,0 cm 1 appliance aperture 58.0 - 59.5 cm 1 pull-out 38.6 cm Article consists of Base and dresser unit, which means there will be joins on the side	40,1-50,0	GO	60	26	55	28	X3A	R/L	▲	940	995	1099	1184	1260	1327	1414	1555	-
		58,0-59,5	Not available for: MIAMI, VIVA If including side panels in the design, we recommend the front lines																

# Appliance unit 259.8 cm high for refrigerator/freezer

Carcass depth 55.5 cm (standard)

▲ = Types also available with 61 cm carcass depth (order no. ... replace ... 55 ... with 61) Integrated ventilation not possible with appliances with motor in the plinth (Cool Concept)

	<b>Appliance unit</b> 1 compensation door 4 adjustable shelves 1 appliance aperture 44.0 - 47.0 cm 1 integrated appliance aperture 88 cm 1 door 90.6 cm Article consists of Base and dresser unit, which means there will be joins on the side	44,0-47,0	GOI	60	26	55	11	XA	R/L	▲	856	916	1046	1163	1240	1299	1398	1538	-
		88,0	Not available for: MIAMI, VIVA If including side panels in the design, we recommend the front lines Important: Observe the appliance manufacturers' permitted front weights for fixed door assembly. See overview of models for front weights.																
	<b>Appliance unit</b> 1 compensation door 3 adjustable shelves 1 appliance aperture 57.0 - 59.5 cm 1 integrated appliance aperture 88 cm 1 door 90.6 cm Article consists of Base and dresser unit, which means there will be joins on the side	57,0-59,5	GOI	60	26	55	21	XA	R/L	▲	807	853	960	1050	1129	1195	1289	1418	-
		88,0	Not available for: MIAMI, VIVA If including side panels in the design, we recommend the front lines Important: Observe the appliance manufacturers' permitted front weights for fixed door assembly. See overview of models for front weights.																
	<b>Appliance unit with integrated ventilation</b> 1 compensation door 3 adjustable shelves 1 integrated appliance aperture 103 cm 1 variable door 105.3 - 116.6 cm 1 pull-out 38.6 cm Article consists of Base and dresser unit, which means there will be joins on the side	103,0	GIB	60	26	55	40	X1A	R/L	▲	1027	1078	1201	1320	1395	1452	1551	1706	-
		Not available for: MIAMI, VIVA If including side panels in the design, we recommend the front lines																	
	<b>Appliance unit with integrated ventilation</b> 1 compensation door 4 adjustable shelves 1 integrated appliance aperture 122.5 cm 1 variable door 131.9 - 142.6 cm Article consists of Base and dresser unit, which means there will be joins on the side	122,5	GIB	60	26	55	50	XA	R/L	▲	889	957	1101	1270	1400	1472	1589	1748	-
		Not available for: MIAMI, VIVA If including side panels in the design, we recommend the front lines Important: Observe the appliance manufacturers' permitted front weights for fixed door assembly. See overview of models for front weights.																	
	<b>Appliance unit with integrated ventilation</b> 1 compensation door 3 adjustable shelves 1 integrated appliance aperture 123 cm 1 variable door 142.7 - 155.6 cm Article consists of Base and dresser unit, which means there will be joins on the side	123,0	GIB	60	26	55	55	X4A	R/L	▲	878	928	1052	1174	1249	1308	1405	1546	-
		Not available for: CASTELLO, FRAME, MIAMI, MUNICH, NEVADA, VINO, VIVA If including side panels in the design, we recommend the front lines Important: Observe the appliance manufacturers' permitted front weights for fixed door assembly. See overview of models for front weights.																	
	<b>Appliance unit with integrated ventilation</b> 1 compensation door 3 adjustable shelves 1 integrated appliance aperture 140.0 cm 1 variable door 149.4 - 155.6 cm Article consists of Base and dresser unit, which means there will be joins on the side	140,0	GIB	60	26	55	62	X4A	R/L	▲	957	1011	1133	1255	1328	1391	1487	1636	-
		Not available for: CASTELLO, FRAME, MIAMI, MUNICH, NEVADA, VINO, VIVA If including side panels in the design, we recommend the front lines Important: Observe the appliance manufacturers' permitted front weights for fixed door assembly. See overview of models for front weights.																	



# 6.9

## Dresser units for Tall units

Dresser units XL 6.9.1-XL 6.9.2  
Dresser units with glass fronts XL 6.9.2

### Legend:



Available with grip ledge N...



Not available with grip ledge N...



This symbol indicates which models are available



This symbol indicates which models are not available



wall-mounted units



available depths for wall-mounted units



Planning advice



This symbol illustrates which appliance units are delivered with integrated ventilation



Not available with „push-to-open“ fitting



Aperture height specifications



Available carcass depths 34/45.5/55.5/61.0 cm



Available carcass depths 45.5/55.5/61.0 cm




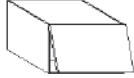
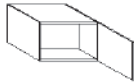



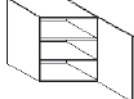
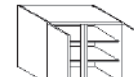


Available carcass depths 55.5/61.0 cm



Dresser units  
for tall units

# Dresser units

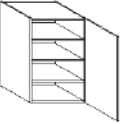

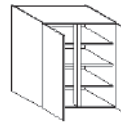

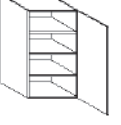

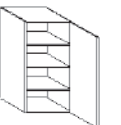

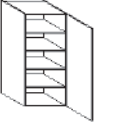



☐ = Models also available in 45.5/61 cm carcass depth (order no.: replace ... 55 ... with 45/61)

	Order no.	W	H	D	Hinge side:	Carcass depth	Price groups									
							1	2	3	4	5	6	7	8	9	
 <p><b>Dresser unit</b> 1 flap door 25.6 cm</p>	A	30	26	55	78		☐	214	218	234	261	280	290	298	328	-
	A	40	26	55	78		☐	214	218	234	261	280	290	298	328	-
	A	45	26	55	78		☐	214	218	234	261	280	290	298	328	-
	A	50	26	55	78		☐	214	218	234	261	280	290	298	328	-
	A	60	26	55	78		☐	218	227	242	281	298	310	332	365	-
	A	80	26	55	78		☐	233	239	262	316	365	383	418	460	-
	A	90	26	55	78		☐	233	239	262	316	365	383	418	460	-
	A	100	26	55	78		☐	242	261	277	328	378	396	434	477	-
 <p><b>Dresser unit</b> 1 flap door 38.6 cm</p>	A	30	39	55	78		☐	220	227	242	275	288	300	310	341	-
	A	40	39	55	78		☐	220	227	242	275	288	300	310	341	-
	A	45	39	55	78		☐	220	227	242	275	288	300	310	341	-
	A	50	39	55	78		☐	220	227	242	275	288	300	310	341	-
	A	60	39	55	78		☐	227	236	251	290	310	323	349	384	-
	A	70	39	55	78		☐	273	284	303	351	373	388	435	479	-
	A	75	39	55	78		☐	273	284	303	351	373	388	435	479	-
	A	80	39	55	78		☐	273	284	303	351	373	388	435	479	-
	A	90	39	55	78		☐	273	284	303	351	373	388	435	479	-
A	100	39	55	78		☐	280	292	311	361	383	398	447	492	-	
 <p><b>Dresser unit</b> 1 door 38.6 cm</p>	A	30	39	55	70	R/L	☐	143	147	162	193	211	223	232	255	-
	A	40	39	55	70	R/L	☐	143	147	162	193	211	223	232	255	-
	A	45	39	55	70	R/L	☐	143	147	162	193	211	223	232	255	-
	A	50	39	55	70	R/L	☐	143	147	162	193	211	223	246	271	-
	A	60	39	55	70	R/L	☐	147	156	171	213	232	246	269	296	-
 <p><b>Dresser unit</b> 2 doors 38.6 cm</p>	A	80	39	55	70		☐	187	195	217	320	361	377	411	452	-
	A	90	39	55	70		☐	187	195	217	320	368	390	423	465	-
	A	100	39	55	70		☐	194	202	226	328	378	395	432	475	-
 <p><b>Dresser unit</b> 1 door 51.6 cm 1 adjustable shelf</p>	A	30	52	55	70	R/L	☐	269	278	301	352	369	383	413	454	-
	A	40	52	55	70	R/L	☐	269	278	301	356	369	390	417	459	-
	A	45	52	55	70	R/L	☐	269	278	301	356	369	390	417	459	-
	A	50	52	55	70	R/L	☐	269	278	301	356	390	412	446	491	-
	A	60	52	55	70	R/L	☐	301	312	328	392	437	462	500	550	-
	A	70	52	55	70	R/L	☐	376	390	410	490	546	578	625	688	-
	A	75	52	55	70	R/L	☐	376	390	410	490	546	578	625	688	-
 <p><b>Dresser unit</b> 2 doors 51.6 cm 1 adjustable shelf</p>	A	80	52	55	70		☐	325	338	364	487	570	608	671	738	-
	A	90	52	55	70		☐	325	338	364	487	570	608	671	738	-
	A	100	52	55	70		☐	334	346	377	501	565	604	671	738	-
 <p><b>Dresser unit</b> 1 door 64.6 cm 2 adjustable shelves</p>	A	30	65	55	70	R/L	☐	279	287	311	361	377	393	422	464	-
	A	40	65	55	70	R/L	☐	279	287	311	366	377	400	425	468	-
	A	45	65	55	70	R/L	☐	279	287	311	366	377	400	425	468	-
	A	50	65	55	70	R/L	☐	279	287	311	366	400	421	458	504	-
	A	60	65	55	70	R/L	☐	312	323	340	403	446	473	512	563	-
	A	70	65	55	70	R/L	☐	390	404	425	504	558	591	640	704	-
	A	75	65	55	70	R/L	☐	390	404	425	504	558	591	640	704	-
 <p><b>Dresser unit</b> 2 doors 64.6 cm 2 adjustable shelves</p>	A	80	65	55	70		☐	339	351	374	498	582	621	685	754	-
	A	90	65	55	70		☐	339	351	374	498	582	621	685	754	-
	A	100	65	55	70		☐	352	364	398	519	582	621	689	758	-
 <p><b>Dresser unit</b> 1 door 77.6 cm 2 adjustable shelves</p>	A	30	78	55	70	R/L	☐	294	303	324	374	419	443	484	532	-
	A	40	78	55	70	R/L	☐	294	303	324	374	419	443	484	532	-
	A	45	78	55	70	R/L	☐	294	303	324	374	419	443	484	532	-
	A	50	78	55	70	R/L	☐	294	303	324	374	419	443	484	532	-
	A	60	78	55	70	R/L	☐	317	328	348	412	455	482	522	574	-
	A	70	78	55	70	R/L	☐	396	410	435	515	569	603	653	718	-
	A	75	78	55	70	R/L	☐	396	410	435	515	569	603	653	718	-
 <p><b>Dresser unit</b> 2 doors 77.6 cm 2 adjustable shelves</p>	A	80	78	55	70		☐	359	367	401	541	631	676	744	818	-
	A	90	78	55	70		☐	359	367	401	541	631	676	744	818	-
	A	100	78	55	70		☐	359	367	401	541	631	676	744	818	-

☐ = extra charge for wall-mounted units, item: **MP-WST2**  
 ☐ = extra charge for wall-mounted units, item: **MP-WST**



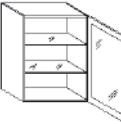
## Dresser units

☐ = Models also available in 45.5/61 cm carcass depth (order no.: replace ... 55 ... with 45/61)

	Order no. W H D	Hinge side: R/L	Carcass depth	Price groups										
				1	2	3	4	5	6	7	8	9		
 <p><b>Dresser unit</b> 1 door 90.6 cm 3 adjustable shelves</p>	MP-WST2	A	30 91 55 70	R/L	☐	356	381	427	456	488	507	542	596	-
		A	40 91 55 70	R/L	☐	356	381	427	456	488	507	542	596	-
		A	45 91 55 70	R/L	☐	356	381	427	456	488	507	542	596	-
		A	50 91 55 70	R/L	☐	356	381	427	456	488	507	542	596	-
		A	60 91 55 70	R/L	☐	356	381	427	456	488	507	542	596	-
				 Item MP-WST2 is necessary for wall-hanging units										
 <p><b>Dresser unit</b> 2 doors 90.6 cm 3 adjustable shelves</p>	MP-WST2	A	80 91 55 70		☐	593	648	739	793	858	898	968	1065	-
		A	90 91 55 70		☐	593	648	739	793	858	898	968	1065	-
		A	100 91 55 70		☐	593	648	739	793	858	898	968	1065	-
						 Item MP-WST2 is necessary for wall-hanging units								
 <p><b>Dresser unit</b> 1 door 103.6 cm 3 adjustable shelves</p>	MP-WST2	A	30 10 55 70	R/L	☐	417	441	504	526	560	585	621	683	-
		A	40 10 55 70	R/L	☐	417	441	504	526	560	585	621	683	-
		A	45 10 55 70	R/L	☐	417	441	504	526	560	585	621	683	-
		A	50 10 55 70	R/L	☐	417	441	504	526	560	585	621	683	-
		A	60 10 55 70	R/L	☐	417	441	504	526	560	585	621	683	-
				 Item MP-WST2 is necessary for wall-hanging units										
 <p><b>Dresser unit</b> 1 door 116.6 cm 3 adjustable shelves</p>	MP-WST2	A	30 11 55 70	R/L	☐	425	459	525	550	586	613	649	714	-
		A	40 11 55 70	R/L	☐	425	459	525	550	586	613	649	714	-
		A	45 11 55 70	R/L	☐	425	459	525	550	586	613	649	714	-
		A	50 11 55 70	R/L	☐	425	459	525	550	586	613	649	714	-
		A	60 11 55 70	R/L	☐	425	459	525	550	586	613	649	714	-
				 Item MP-WST2 is necessary for wall-hanging units										
 <p><b>Dresser unit</b> 1 door 129.6 cm 4 adjustable shelves</p>	MP-WST2	A	30 13 55 70	R/L	☐	430	476	546	573	613	640	677	745	-
		A	40 13 55 70	R/L	☐	430	476	546	573	613	640	677	745	-
		A	45 13 55 70	R/L	☐	430	476	546	573	613	640	677	745	-
		A	50 13 55 70	R/L	☐	430	476	546	573	613	640	677	745	-
		A	60 13 55 70	R/L	☐	430	476	546	573	613	640	677	745	-
				 Item MP-WST2 is necessary for wall-hanging units										
	<b>Extra charge for heavy-duty fittings wall-mounted units</b>		MP-WST			105								
	<b>Extra charge for heavy-duty fittings wall-mounted units</b>		MP-WST2			228								

## Dresser units with glass fronts

☐ = Models also available in 45.5/61 cm carcass depth (order no.: replace ... 55 ... with 45/61)

	Order no. W H D	Hinge side: R/L	Carcass depth	Glass groups					
				G1	G2	G2S	G5S	G6	
 <p><b>Dresser unit with glass front</b> -neutral- 1 glass door 64.6 cm 1 adjustable glass shelf</p>	AGD	45 65 55	R/L	☐	-	519	519	569	903
			R/L	☐	-	541	541	599	925
			R/L	☐	-	581	581	640	965
 <p><b>Dresser unit with glass front</b> -neutral- 1 glass door 77.6 cm 2 adjustable glass shelves</p>	AGD	45 78 55	R/L	☐	-	542	542	623	926
			R/L	☐	-	558	558	643	942
			R/L	☐	-	596	596	675	980
 <p><b>Dresser unit with glass front</b> -neutral- 1 glass door 90.6 cm 3 adjustable glass shelves</p>	AGD	45 91 55	R/L	☐	-	560	560	643	944
			R/L	☐	-	580	580	668	964
			R/L	☐	-	615	615	695	999
<b>G 1</b>		<b>G 2</b>		<b>G 2S</b>					
G1 AKTIV/glass frame		G2 Design front		G2S aluminium, framed glass door					
<b>G 5</b>		<b>G 5S</b>		<b>G 6</b>					
		G5S aluminium, door with mullion		G6 NEW SALON					

# Sliding door solutions for tall units

# 6.10

Inspirations	XL 6.10.2-XL 6.10.3
Pocketsystem	XL 6.10.4-XL 6.10.5
Housing set for retractable doors	XL 6.10.1
Tall units behind retractable doors Carcase height 192.9 cm	XL 6.10.1
Sliding door system SlideLine M	XL 6.10.6
Sliding doors / tall units SlideLine M	XL 6.10.7
Sliding doors / tall units SlideLine M	XL 6.10.7-XL 6.10.9

## Legend:



Available with grip ledge N...



Not available with grip ledge N...



This symbol indicates which models are available



This symbol indicates which models are not available



wall-mounted units



available depths for wall-mounted units



Planning advice



This symbol illustrates which appliance units are delivered with integrated ventilation



Not available with „push-to-open“ fitting



Aperture height specifications



Available carcase depths 34/45.5/55.5/61.0 cm



Available carcase depths 45.5/55.5/61.0 cm



Available carcase depths 55.5/61.0 cm

Sliding door solutions  
for tall units



# Pocketsystem

## Pocket system

carcase height 230.8 cm  
Pocket depth 71.6 cm / total depth approx. 73.8 cm

### New perspectives - design in motion

The new „Pocketdoor system“ product category opens up completely new perspectives. This system is the perfect solution for multi-functional room utilisation: it is a unique retractable door system with fully integrated technology. Both in the single and double-door version, the full overlay fronts disappear into their own narrow carcass, the pocket.

The retractable doors upgrade the practical value and design of furniture: wall, tall and base units in kitchen planning can thus be set cleverly into the background. The flush-mounted retractable doors fascinate due to their purist appearance. The retractable doors, delivered in one piece in height, have an impressive appearance and are equipped with high-quality TIP-ON door opening fitting.

### Your ideas make the difference

With a sliding movement, the flush-fitting sliding doors open to the side and open up onto a large functional space. The accessible interior space that is now available is not only practical, but also enables the convenient storage of kitchen utensils and electrical appliances. All electrical appliances such as refrigerators, ovens, steamers, warming drawers, dishwashers, hobs and downdraft fans as well as washing machines and tumble dryers can be planned and installed in the pocket element (applies only to EU countries).

Important note: gas hobs cannot be installed. Heat-generating devices may only be connected via the SafetyBox. When planning, the number and performance of the devices must be taken into account.

Sockets and work sockets installed on site must also be protected by the automatic switch-off. A maximum of 3 automatic switch-offs can be connected per Pocketdoor element. They may only be planned above the Pocketdoor element.

### Which units can be planned in the interior?

- General unit elements from the XL series
- Tall units with an overall height of 207.8 cm and 10 cm plinth height
- Base units and wall units
- Further planning with tall units with a carcass height of 220.8 cm and 10 cm plinth (please take front extension into consideration)

### Planning advice:

When planning, please take into consideration that height, depth and width reductions are not possible. The Pocketdoor element is only available with continuous fronts and only without handles, because TIP-ON technology is used as standard. Unit models with wide angle hinges may not be planned directly adjacent to the Pocketdoor element.

There is a risk of collision due to the front overhang of the pocket element compared to the connected units.

Particular attention should be paid here to the design and position of the handles, as well as to the unit equipment (e.g. with internal pull-outs).

Planning free-standing electrical appliance directly adjacent to the Pocketdoor element is not possible.

Directly next to the Pocket area, appliances may only be used in the carcass or carcass substructure. The appliance depth from the front edge of the carcass to the front edge of the appliance handle must not be more than 100 mm.

Caution: Observe the installation instructions of the appliance manufacturer

The elements must not be planned to be free-standing. It is mandatory to use a wall mount. The Pocketdoor system cannot be used as passage elements.

Warming appliances may only be planned with an automatic switch-off - the automatic switch-off must be ordered separately.

Contact switches / distributors for the automatic switch-off are generally installed on the Pocket.

The automatic door opening function must be switched off in dishwashers after the end of the program.

Planning external panels on the Pocket element is NOT possible!

Pocket external sides can be planned as a visible side design.

### Colour version:

Pocket external side	carcase colour
Pocket interior side	carcase colour
Intermediate shelf	carcase colour
panel	carcase colour





# Pocketsystem

Bare inside width	Bare inside height	Bare inside depth	Planning width	Planning depth	Planning height	Article no.	Version	Door height (incl. front extension)	Legend
60 cm	217.8 cm (207.8 cm + 10 cm plinth)	max. for carcase depth 55.5 cm	71.6 cm	71.6 cm	230.8 cm	PD 1T 60 22 70	L	229.1 cm	single door with end modular panel 1.6 mm
60 cm	217.8 cm (207.8 cm + 10 cm plinth)	max. for carcase depth 55.5 cm	71.6 cm	71.6 cm	230.8 cm	PD 1T 60 22 70	R	229.1 cm	single door with end modular panel 1.6 mm
120 cm	217.8 cm (207.8 cm + 10 cm plinth)	max. for carcase depth 55.5 cm	140 cm	71.6 cm	230.8 cm	PD 2T 120 22 70		229.1 cm	2 single doors
120 cm	217.8 cm (207.8 cm + 10 cm plinth)	max. for carcase depth 55.5 cm	136.6 cm	71.6 cm	230.8 cm	PD FT 120 22 70	L	229.1 cm	1 folding door with end modular panel 1.6 mm
120 cm	217.8 cm (207.8 cm + 10 cm plinth)	max. for carcase depth 55.5 cm	136.6 cm	71.6 cm	230.8 cm	PD FT 120 22 70	R	229.1 cm	1 folding door with end modular panel 1.6 mm
180 cm	217.8 cm (207.8 cm + 10 cm plinth)	max. for carcase depth 55.5 cm	205 cm	71.6 cm	230.8 cm	PD TFT 180 22 70	L	229.1 cm	1 single door left, 1 folding door right
180 cm	217.8 cm (207.8 cm + 10 cm plinth)	max. for carcase depth 55.5 cm	205 cm	71.6 cm	230.8 cm	PD TFT 180 22 70	R	229.1 cm	1 single door right, 1 folding door left
240 cm	217.8 cm (207.8 cm + 10 cm plinth)	max. for carcase depth 55.5 cm	270 cm	71.6 cm	230.8 cm	PD 2FT 240 22 70		229.1 cm	2 folding doors

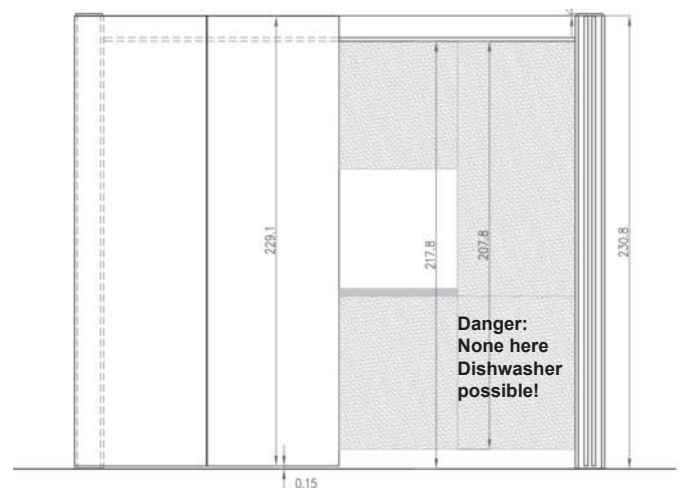
Enclosures and superstructures in connection with the pocket door elements are possible with a distance of 1.5 cm to the top edge of the pocket (pocket door top edge = planning height).

Which electrical devices need an automatic switch-off?

Built-in oven	x	chip pan	x
built-in cooker	x	extractor fan	x
compact oven	x	dishwasher	
microwave	x	cooker hood	
steamer	x	Maturing unit (dry ager)	
pressure cooker	x	TV appliance	
coffee machine	x	washing machine	
all refrigerating devices		tumble dryer	x
hob	x	vacuum drawer	
multi-hob	x	warming drawer	x
Tepan Yaki	x	work sockets	x
wok	x	LED lighting	

Planning advice:

Directly next to the Pocket area, appliances may only be used in the carcase or carcase substructure. The appliance depth from the front edge of the carcase to the front edge of the appliance handle must not be more than 100 mm. Important: Follow the assembly instructions from the appliance manufacturers.



Price groups

Order no.  
W H D

Hinge side: Carcase depth	Price groups								
	1	2	3	4	5	6	7	8	9

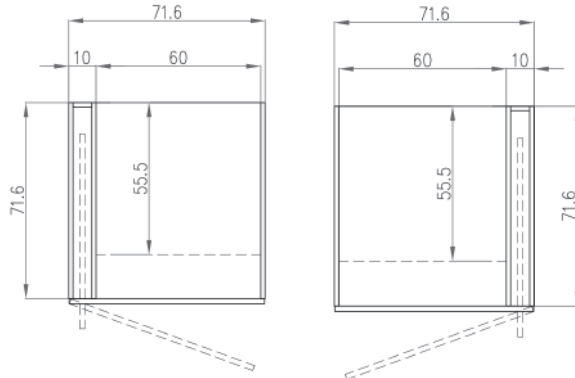
2206



**Pocketdoor element**  
**1x single-door slide-in door**  
 consisting of:  
 1 top shelf in carcase decor  
 1 panel in carcase decor  
 1 pocket element with slide-in door fitting in carcase decor  
 1 slide-in door with TIP-ON door opening fitting  
 bare width: 60 cm wide  
 External dimensions:  
 WxHxD 71.6 x 230.8 x 71.6 cm



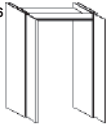
PD	1T	60	22	70	R/L	3575	3783	3826	4535	4581	4618	5079	5587	-
<p><b>Available for:</b>                      ARTE-B, ARTE-S, BAVARIA, CASA-B, EDITION, FENIX INOX, FLORENZ, GENT, HPL PRO, MALMÖ, MONTANA, MPX, NEW OPAL-M, OPAL-H, PALAZZO, PALERMO-B, PALERMO-S, PRIMEWOOD TOP, PUR, RESOPAL, RESOPAL PRO, RESOPAL PRO EDGE, RIVA, RUSTY OAK, SHERWOOD, SIGNUM-B, SMART, SMART MIRROR, SMART-M, TALEA, TIM, TOP</p> <p><b>Planning advice:</b>                      height, depth or width reductions are not possible.                      Only continuous fronts are possible.                      Always plan without handle on the slide-in doors (fitted with TIP-ON as standard)</p>														



Ill. left

Ill. right

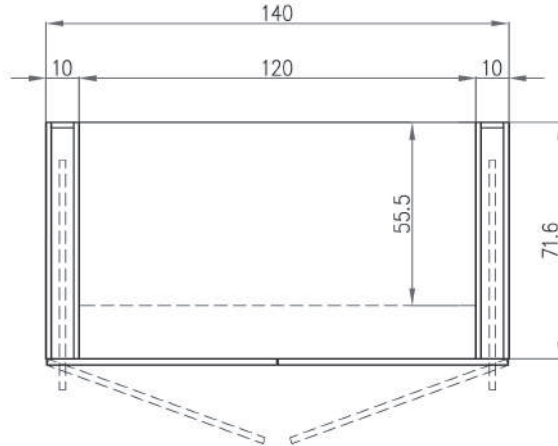
2206



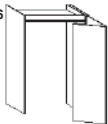
**Pocketdoor element**  
**2x single-door slide-in door**  
 consisting of:  
 1 top shelf in carcase decor  
 1 panel in carcase decor  
 2 pocket elements with slide-in door fitting in carcase decor  
 2 slide-in doors with TIP-ON door opening fitting  
 bare width: 120 cm wide  
 External dimensions:  
 WxHxD 140 x 230.8 x 71.6 cm



PD	2T	120	22	70	R/L	6573	6987	7073	8493	8585	8658	9580	10538	-
<p><b>Available for:</b>                      ARTE-B, ARTE-S, BAVARIA, CASA-B, EDITION, FENIX INOX, FLORENZ, GENT, HPL PRO, MALMÖ, MONTANA, MPX, NEW OPAL-M, OPAL-H, PALAZZO, PALERMO-B, PALERMO-S, PRIMEWOOD TOP, PUR, RESOPAL, RESOPAL PRO, RESOPAL PRO EDGE, RIVA, RUSTY OAK, SHERWOOD, SIGNUM-B, SMART, SMART MIRROR, SMART-M, TALEA, TIM, TOP</p> <p><b>Planning advice:</b>                      height, depth or width reductions are not possible.                      Only continuous fronts are possible.                      Always plan without handle on the slide-in doors (fitted with TIP-ON as standard)</p>														



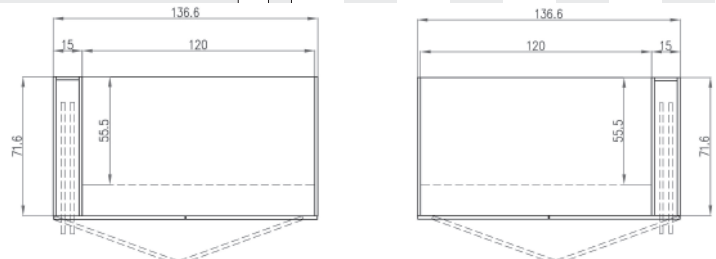
2206



**Pocket door element**  
**1x double-door folding slide-in door**  
 consisting of:  
 1 top shelf in carcase decor  
 1 panel in carcase decor  
 1 pocket element with slide-in door fitting in carcase decor  
 1 single-door folding slide-in door with TIP-ON door opening fitting  
 1 panel 1.6 cm, exterior in carcase colour  
 bare width: 120 cm wide  
 External dimensions:  
 WxHxD 136.6 x 230.8 x 71.6 cm



PD	FT	120	22	70	R/L	6138	6542	6627	8011	8101	8173	9072	9979	-
<p><b>Available for:</b>                      ARTE-B, ARTE-S, BAVARIA, CASA-B, EDITION, FENIX INOX, FLORENZ, GENT, HPL PRO, MALMÖ, MONTANA, MPX, NEW OPAL-M, OPAL-H, PALAZZO, PALERMO-B, PALERMO-S, PRIMEWOOD TOP, PUR, RESOPAL, RESOPAL PRO, RESOPAL PRO EDGE, RIVA, RUSTY OAK, SHERWOOD, SIGNUM-B, SMART, SMART MIRROR, SMART-M, TALEA, TIM, TOP</p> <p><b>Planning advice:</b>                      height, depth or width reductions are not possible.                      Only continuous fronts are possible.                      Always plan without handle on the slide-in doors (fitted with TIP-ON as standard)</p>														

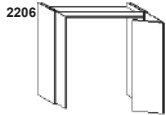


Ill. left

Ill. right

Order no.  
W H D

Hinge side: Carcase depth	1	2	3	4	5	6	7	8	9
	9541	10163	10292	12421	12559	12669	14052	15457	-



**Pocketdoor element**  
**1x double-door folding slide-door**  
**and 1x single-door slide-in door**  
 consisting of:  
 1 top shelf in carcase decor  
 1 panel in carcase decor  
 2 pocket elements with slide-in door fitting in carcase decor  
 1 single-door folding slide-in door with TIP-ON door opening fitting  
 1 slide-in door with TIP-ON door opening fitting  
 bare width: 180 cm wide  
 External dimensions:  
 WxHxD 205 x 230.8 x 71.6 cm

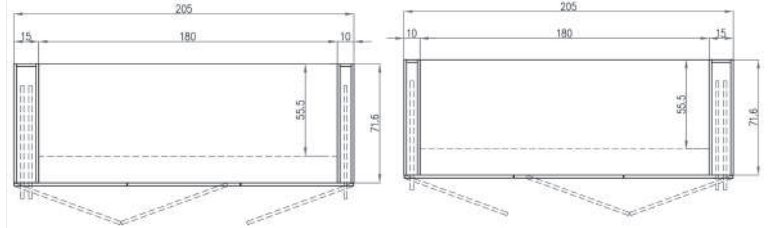


<b>PD</b>	<b>TFT</b>	<b>180</b>	<b>22</b>	<b>70</b>	R/L	9541	10163	10292	12421	12559	12669	14052	15457	-
-----------	------------	------------	-----------	-----------	-----	------	-------	-------	-------	-------	-------	-------	-------	---

**Available for:**  
 ARTE-B, ARTE-S, BAVARIA, CASA-B, EDITION, FENIX INOX, FLORENZ, GENT, HPL PRO, MALMÖ, MONTANA, MPX, NEW OPAL-M, OPAL-H, PALAZZO, PALERMO-B, PALERMO-S, PRIMEWOOD TOP, PUR, RESOPAL, RESOPAL PRO, RESOPAL PRO EDGE, RIVA, RUSTY OAK, SHERWOOD, SIGNUM-B, SMART, SMART MIRROR, SMART-M, TALEA, TIM, TOP

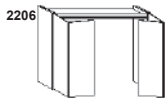


**Planning advice:**  
 height, depth or width reductions are not possible.  
 Only continuous fronts are possible.  
 Always plan without handle on the slide-in doors (fitted with TIP-ON as standard)



III. right

III. left



**Pocket door element**  
**2x double-door folding slide-in doors**  
 consisting of:  
 1 top shelf in carcase decor  
 1 panel in carcase decor  
 2 pocket elements with slide-in door fitting in carcase decor  
 2 double-door folding slide-in doors with TIP-ON door opening fitting  
 bare width: 240 cm wide  
 External dimensions:  
 WxHxD 270 x 230.8 x 71.6 cm

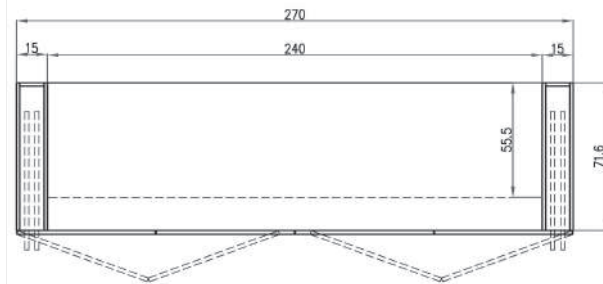


<b>PD</b>	<b>TFT</b>	<b>240</b>	<b>22</b>	<b>70</b>	R/L	11522	12322	12488	15224	15402	15544	17321	19053	-
-----------	------------	------------	-----------	-----------	-----	-------	-------	-------	-------	-------	-------	-------	-------	---

**Available for:**  
 ARTE-B, ARTE-S, BAVARIA, CASA-B, EDITION, FENIX INOX, FLORENZ, GENT, HPL PRO, MALMÖ, MONTANA, MPX, NEW OPAL-M, OPAL-H, PALAZZO, PALERMO-B, PALERMO-S, PRIMEWOOD TOP, PUR, RESOPAL, RESOPAL PRO, RESOPAL PRO EDGE, RIVA, RUSTY OAK, SHERWOOD, SIGNUM-B, SMART, SMART MIRROR, SMART-M, TALEA, TIM, TOP



**Planning advice:**  
 height, depth or width reductions are not possible.  
 Only continuous fronts are possible.  
 Always plan without handle on the slide-in doors (fitted with TIP-ON as standard)



**SafetyBox**  
**SafetyBox for 3 phase connection**  
 Automatic switch-off for electronic appliances in kitchen furniture  
 For safety reasons, the SafetyBox SBOX-P3 is required for the connection of heat-generating appliances such as ovens, steam cookers etc. for each half of a tall unit sliding door system (prevention of overheating and damage to appliance). To prevent overheating, the appliance (e.g. oven) will be switched off when the sliding door is closed.  
 The appliance will not be switched off if it is not in use so programme settings and times are retained.  
 consisting of:  
 1 reed contact switch for the controller  
 Connection:  
 a) Input  
 5-core mains cable, 2.5 m long  
 Connection to 3 phases  
 On-site fuse protection max. 16 A per phase  
 b) Output  
 3 connection couplings with earthed plug  
 Appliances for mains power 230-240 V AC, 50-60 Hz  
 Max. appliance power 3.6 kW per appliance

**SBOX-P3**

706



Note: The SafetyBox must be installed by a professional

**As above, version for Switzerland**  
 With 250 cm long 5-core mains cable

**SBOX-P3CH**

771

# Sliding door system SlideLine M



## Design in motion

SlideLine M upgrades the practical value and design of furniture:

wall, tall and base units in kitchen planning, and living room units made from the panel and shelf unit system.

### It's your ideas that decide.

With SlideLine M simple shelf units become appealing

functional furniture with looks that can be changed again and again.

Sliding the doors to different positions creates ever-changing constellations of open and closed elements. This gets things moving in your furniture design and never fails to please.

It's your ideas that decide.

Discover the wealth of applications for SlideLine M.

## Note:

Always use sliding door systems in isolation, because the fitting with front-flush shelves adds 33 mm, thus protruding beyond standard units.

## Base units:

Carcase widths:

45 cm, 50 cm, 60 cm, 80 cm, 90 cm

Carcase depths: 57.5 cm, 47.5 cm, 36.1 cm

Door widths: 45 cm, 50 cm, 60 cm, 80 cm, 90 cm

Door heights: 39 cm, 52 cm, 65 cm, 71.5 cm, 78 cm

## Wall units:

Carcase widths:

45 cm, 50 cm, 60 cm, 80 cm, 90 cm

Carcase depth: 36.1 cm

Door widths: 45 cm, 50 cm, 60 cm, 80 cm, 90 cm

Door heights: 39 cm, 52 cm, 65 cm, 78 cm, 91 cm

## Tall units:

Carcase widths:

30 cm, 40 cm, 45 cm, 50 cm, 60 cm

Carcase depths: 57.5 cm, 47.5 cm, 36.1 cm

Door widths: 90 cm

Door heights: 143 cm, 156 cm, 168.8 cm, 181.8 cm,

194.8 cm, 207.8 cm, 220.8 cm

**Important:** Because of fixed front width of 90 cm, the following carcass width combinations are possible (45/45 cm, 40/50 cm, 60/30 cm)

## Why SlideLine M?

Simple shelf units become appealing functional furniture with looks that can be changed again and again.

SlideLine M facilitates the playful interchange between open and closed sections.

The SlideLine M sliding door system ensures that no open doors are ever in the way, so do not create an obstruction in tight passages.

The smooth running action adds to the comfort, as does the cushioned closing of even heavy doors.

High-quality function and smart design, since the Silent System cushioning is integrated, out of sight,

on the inside of the front.

Even with several doors in one profile, they can still be cushioned to ensure blissful piece and quiet.

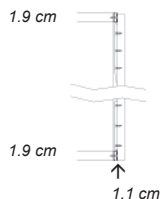
And because the end position of the doors can be chosen to suit,

the end customer has a high level of design freedom.

# Sliding doors / tall units SlideLine M

The shelf elements UR..., HR... and GR... are also available for planning. These items are to be found in the sections Base units, Wall units and Tall units.

■ = Models also available in 34/45.5/61 cm carcass depth (Order no.: ... replace ... 55 ... with 34/45/61)



Design suggestion in conjunction with tall units comprising

- 1x SLG 60 22 55 13
- 1x GR 30 22 58
- 1x SLG 30 22 55 13
- 1x SLG 60 22 55 32
- 1x SLGF 90 221
- 1x SL-SET 19

Order no. W H D		Hinge side: Carcass depth	Price groups								
			1	2	3	4	5	6	7	8	9
1426	<b>Sliding door for tall unit height 143 cm</b> 142.6 cm high incl. 2 tightening fittings complete with fittings	<b>SLGF 90 143</b> Not available for: ALU TEC RP, ALUELEMENTS, ATLANTA-B, ATLANTA-S, BERGEN, CASTELLO, CHALET-B, CHALET-S, CHICAGO, FRAME, INTARSIA, LUGANO, LUX-B, MIAMI, NOBEL-B, NOBEL-S, ORLANDO-B, ORLANDO-S, OSLO 15, PALERMO-B, PALERMO-S, ROMA-B, ROMA-S, SOFIE-B, SOFIE-S, STRIP ELEMENTS, TALEA, TESSIN 15, TIM 15, VILLAGE 15-B, VILLAGE 15-S, VINO, VIVA, YORK-B, YORK-S	713	823	1034	1180	1532	1561	1812	1993	-
		<b>SLG 30 14 55 13</b> ■ 898 <b>SLG 40 14 55 13</b> ■ 913 <b>SLG 45 14 55 13</b> ■ 919 <b>SLG 50 14 55 13</b> ■ 920 <b>SLG 60 14 55 13</b> ■ 926 Not available for: ALU TEC RP									
	<b>Tall unit height 143 cm</b> without front 1 adjustable shelf 1 fixed shelf 1 internal drawer 3 internal pull-outs	<b>SLG 30 14 55 32</b> ■ 956 <b>SLG 40 14 55 32</b> ■ 975 <b>SLG 45 14 55 32</b> ■ 979 <b>SLG 50 14 55 32</b> ■ 985 <b>SLG 60 14 55 32</b> ■ 995 Not available for: ALU TEC RP									
		<b>SLG 30 15 55 13</b> ■ 920 <b>SLG 40 15 55 13</b> ■ 943 <b>SLG 45 15 55 13</b> ■ 951 <b>SLG 50 15 55 13</b> ■ 958 <b>SLG 60 15 55 13</b> ■ 973 Not available for: ALU TEC RP									
	<b>Tall unit height 143 cm</b> without front 1 adjustable shelf 1 fixed shelf 3 internal drawers 2 internal pull-outs	<b>SLG 30 15 55 32</b> ■ 977 <b>SLG 40 15 55 32</b> ■ 1005 <b>SLG 45 15 55 32</b> ■ 1014 <b>SLG 50 15 55 32</b> ■ 1024 <b>SLG 60 15 55 32</b> ■ 1042 Not available for: ALU TEC RP									
		<b>SLG 30 15 55 32</b> ■ 977 <b>SLG 40 15 55 32</b> ■ 1005 <b>SLG 45 15 55 32</b> ■ 1014 <b>SLG 50 15 55 32</b> ■ 1024 <b>SLG 60 15 55 32</b> ■ 1042 Not available for: ALU TEC RP									
1556	<b>Sliding door for tall unit height 156 cm</b> 155.6 cm high incl. 2 tightening fittings complete with fittings	<b>SLGF 90 156</b> Not available for: ALU TEC RP, ALUELEMENTS, ATLANTA-B, ATLANTA-S, BERGEN, CASTELLO, CHALET-B, CHALET-S, CHICAGO, FRAME, INTARSIA, LUGANO, LUX-B, MIAMI, NOBEL-B, NOBEL-S, ORLANDO-B, ORLANDO-S, OSLO 15, PALERMO-B, PALERMO-S, ROMA-B, ROMA-S, SOFIE-B, SOFIE-S, STRIP ELEMENTS, TALEA, TESSIN 15, TIM 15, VILLAGE 15-B, VILLAGE 15-S, VINO, VIVA, YORK-B, YORK-S	731	849	1079	1242	1625	1659	1928	2121	-
		<b>SLG 30 15 55 13</b> ■ 920 <b>SLG 40 15 55 13</b> ■ 943 <b>SLG 45 15 55 13</b> ■ 951 <b>SLG 50 15 55 13</b> ■ 958 <b>SLG 60 15 55 13</b> ■ 973 Not available for: ALU TEC RP									
	<b>Tall unit height 156 cm</b> without front 2 adjustable shelves 1 fixed shelf 1 internal drawer 3 internal pull-outs	<b>SLG 30 15 55 32</b> ■ 977 <b>SLG 40 15 55 32</b> ■ 1005 <b>SLG 45 15 55 32</b> ■ 1014 <b>SLG 50 15 55 32</b> ■ 1024 <b>SLG 60 15 55 32</b> ■ 1042 Not available for: ALU TEC RP									
		<b>SLG 30 15 55 32</b> ■ 977 <b>SLG 40 15 55 32</b> ■ 1005 <b>SLG 45 15 55 32</b> ■ 1014 <b>SLG 50 15 55 32</b> ■ 1024 <b>SLG 60 15 55 32</b> ■ 1042 Not available for: ALU TEC RP									

# Sliding doors / tall units SlideLine M

The shelf elements UR..., HR... and GR... are also available for planning. These items are to be found in the sections Base units, Wall units and Tall units.

■ = Models also available in 34/45.5/61 cm carcass depth (Order no.: ... replace ... 55 ... with 34/45/61)










1686	<b>Sliding door for tall unit height 168.8 cm</b> 168.8 cm high incl. 2 tightening fittings complete with fittings	<b>SLGF 90 169</b> Not available for: ALU TEC RP, ALUELEMENTS, ATLANTA-B, ATLANTA-S, BERGEN, CASTELLO, CHALET-B, CHALET-S, CHICAGO, FRAME, INTARSIA, LUGANO, LUX-B, MIAMI, NOBEL-B, NOBEL-S, ORLANDO-B, ORLANDO-S, OSLO 15, PALERMO-B, PALERMO-S, ROMA-B, ROMA-S, SOFIE-B, SOFIE-S, STRIP ELEMENTS, TALEA, TESSIN 15, TIM 15, VILLAGE 15-B, VILLAGE 15-S, VINO, VIVA, YORK-B, YORK-S	749	873	1128	1302	1717	1754	2047	2252	-
		Not available for: ALU TEC RP, ALUELEMENTS, ATLANTA-B, ATLANTA-S, BERGEN, CASTELLO, CHALET-B, CHALET-S, CHICAGO, FRAME, INTARSIA, LUGANO, LUX-B, MIAMI, NOBEL-B, NOBEL-S, ORLANDO-B, ORLANDO-S, OSLO 15, PALERMO-B, PALERMO-S, ROMA-B, ROMA-S, SOFIE-B, SOFIE-S, STRIP ELEMENTS, TALEA, TESSIN 15, TIM 15, VILLAGE 15-B, VILLAGE 15-S, VINO, VIVA, YORK-B, YORK-S									



# Sliding doors / tall units SlideLine M

The shelf elements UR..., HR... and GR... are also available for planning. These items are to be found in the sections Base units, Wall units and Tall units.

■ = Models also available in 34/45.5/61 cm carcass depth (Order no.: ... replace ... 55 ... with 34/45/61)

		Order no.	W H D				Hinge side:	Carcass depth	Price groups								
								1	2	3	4	5	6	7	8	9	
	<b>Tall unit height 168.8 cm</b> without front 2 adjustable shelves 1 fixed shelf 1 internal drawer 3 internal pull-outs	SLG 30 16 55 13				■	920										
		SLG 40 16 55 13				■	943										
		SLG 45 16 55 13					■	951									
		SLG 50 16 55 13					■	958									
		SLG 60 16 55 13					■	973									
		Not available for: ALU TEC RP															
	<b>Tall unit height 168.8 cm</b> without front 2 adjustable shelves 1 fixed shelf 3 internal drawers 2 internal pull-outs	SLG 30 16 55 32				■	977										
		SLG 40 16 55 32				■	1005										
		SLG 45 16 55 32					■	1014									
		SLG 50 16 55 32					■	1024									
		SLG 60 16 55 32					■	1042									
		Not available for: ALU TEC RP															
	<b>Sliding door for tall unit height 181.8 cm</b> 181.6 cm high incl. 2 tightening fittings complete with fittings	SLGF 90 182						767	902	1173	1361	1812	1849	2167	2384	-	
		Not available for: ALU TEC RP, ALUELEMENTS, ATLANTA-B, ATLANTA-S, BERGEN, CASTELLO, CHALET-B, CHALET-S, CHICAGO, FRAME, INTARSIA, LUGANO, LUX-B, MIAMI, NOBEL-B, NOBEL-S, ORLANDO-B, ORLANDO-S, OSLO 15, PALERMO-B, PALERMO-S, ROMA-B, ROMA-S, SOFIE-B, SOFIE-S, STRIP ELEMENTS, TALEA, TESSIN 15, TIM 15, VILLAGE 15-B, VILLAGE 15-S, VINO, VIVA, YORK-B, YORK-S															
	<b>Tall unit height 181.8 cm</b> without front 3 adjustable shelves 1 fixed shelf 1 internal drawer 3 internal pull-outs	SLG 30 18 55 13				■	920										
		SLG 40 18 55 13				■	943										
		SLG 45 18 55 13					■	951									
		SLG 50 18 55 13					■	958									
		SLG 60 18 55 13					■	973									
		Not available for: ALU TEC RP															
	<b>Tall unit height 181.8 cm</b> without front 3 adjustable shelves 1 fixed shelf 3 internal drawers 2 internal pull-outs	SLG 30 18 55 32				■	977										
		SLG 40 18 55 32				■	1005										
		SLG 45 18 55 32					■	1014									
		SLG 50 18 55 32					■	1024									
		SLG 60 18 55 32					■	1042									
		Not available for: ALU TEC RP															
	<b>Sliding door for tall unit height 194.8 cm</b> 194.6 cm high incl. 2 tightening fittings complete with fittings	SLGF 90 195						784	929	1220	1425	1903	1945	2283	2511	-	
		Not available for: ALU TEC RP, ALUELEMENTS, ATLANTA-B, ATLANTA-S, BERGEN, CASTELLO, CHALET-B, CHALET-S, CHICAGO, FRAME, INTARSIA, LUGANO, LUX-B, MIAMI, NOBEL-B, NOBEL-S, ORLANDO-B, ORLANDO-S, OSLO 15, PALERMO-B, PALERMO-S, ROMA-B, ROMA-S, SOFIE-B, SOFIE-S, STRIP ELEMENTS, TALEA, TESSIN 15, TIM 15, VILLAGE 15-B, VILLAGE 15-S, VINO, VIVA, YORK-B, YORK-S															
	<b>Tall unit height 194.8 cm</b> without front 3 adjustable shelves 1 fixed shelf 1 internal drawer 3 internal pull-outs	SLG 30 19 55 13				■	929										
		SLG 40 19 55 13				■	953										
		SLG 45 19 55 13					■	964									
		SLG 50 19 55 13					■	969									
		SLG 60 19 55 13					■	982									
		Not available for: ALU TEC RP															
	<b>Tall unit height 194.8 cm</b> without front 3 adjustable shelves 1 fixed shelf 3 internal drawers 2 internal pull-outs	SLG 30 19 55 32				■	987										
		SLG 40 19 55 32				■	1015										
		SLG 45 19 55 32					■	1024									
		SLG 50 19 55 32					■	1034									
		SLG 60 19 55 32					■	1052									
		Not available for: ALU TEC RP															
	<b>Sliding door for tall unit height 207.8 cm</b> 207.6 cm high incl. 2 tightening fittings complete with fittings	SLGF 90 208						802	957	1267	1485	1996	2041	2403	2643	-	
		Not available for: ALU TEC RP, ATLANTA-B, ATLANTA-S, BERGEN, CHALET-B, CHALET-S, CHICAGO, FRAME, GENT, LUX-B, MIAMI, MODENA, MUNICH, NEVADA, NOBEL-B, NOBEL-S, ORLANDO-B, ORLANDO-S, OSLO 15, PADUA, PALERMO-B, PALERMO-S, ROMA-B, ROMA-S, SOFIE-B, SOFIE-S, TIM, TIM 15, VILLAGE 15-B, VILLAGE 15-S, VINO, VIVA, YORK-B, YORK-S															

# Sliding doors / tall units SlideLine M

The shelf elements UR..., HR... and GR... are also available for planning. These items are to be found in the sections Base units, Wall units and Tall units.

■ = Models also available in 34/45.5/61 cm carcass depth (Order no.: ... replace ... 55 ... with 34/45/61)

Order no.  
W H D

Hinge side:	Carcass depth	Price groups								
		1	2	3	4	5	6	7	8	9
■	946	SLG 30 20 55 13								
		SLG 40 20 55 13								
		SLG 45 20 55 13								
		SLG 50 20 55 13								
		SLG 60 20 55 13								
		Not available for: ALU TEC RP								
■	1004	SLG 30 20 55 32								
		SLG 40 20 55 32								
		SLG 45 20 55 32								
		SLG 50 20 55 32								
		SLG 60 20 55 32								
		Not available for: ALU TEC RP								
2206	819 983 1311 1547 2090 2135 2522 2774 -	SLGF 90 221								
Not available for: ALU TEC RP, ATLANTA-B, ATLANTA-S, BERGEN, CHALET-B, CHALET-S, CHICAGO, FRAME, GENT, LUX-B, MIAMI, MODENA, MUNICH, NEVADA, NOBEL-B, NOBEL-S, ORLANDO-B, ORLANDO-S, OSLO 15, PADUA, PALERMO-B, PALERMO-S, ROMA-B, ROMA-S, SOFIE-B, SOFIE-S, TIM, TIM 15, VILLAGE 15-B, VILLAGE 15-S, VINO, VIVA, YORK-B, YORK-S										
■	966	SLG 30 22 55 13								
		SLG 40 22 55 13								
		SLG 45 22 55 13								
		SLG 50 22 55 13								
		SLG 60 22 55 13								
		Not available for: ALU TEC RP								
■	1022	SLG 30 22 55 32								
		SLG 40 22 55 32								
		SLG 45 22 55 32								
		SLG 50 22 55 32								
		SLG 60 22 55 32								
		Not available for: ALU TEC RP								
■	181	SL-SET19								
Fittings for sliding doors profile set For shelf thickness 19 mm Complete with top and bottom runner profile (aluminium anodised) and ABS decor profile to be glued 300 cm long, to be shortened on-site Incl. end caps and assembly clips Fixing screws										





## Living room furniture, special elements

Living elements

Comfort kitchen

System

MULTIROOM

ALUELEMENTS

FREEWORLD

System dressing room  
Dressing Room



## 7.1

## Living elements

Homestory	XL 7.1.1-XL 7.1.2
Base units 26 cm high	XL 7.1.3
Base shelf units 26 cm high	XL 7.1.3
Base units 39 cm high	XL 7.1.4
Base shelf units 39 cm high	XL 7.1.4
Base units 78 cm high	XL 7.1.5
Base units with glass fronts	XL 7.1.6
Base units Back cladding	XL 7.1.7
Base units Visible sides / increased side depth	XL 7.1.7
Wall units Carcase height 39 cm, 52 cm and 65 cm	XL 7.1.8
Wall units with glass fronts Carcase height 39 cm, 52 cm and 65 cm	XL 7.1.9-XL 7.1.10
Wall shelf unit Smart Cube	XL 7.1.11
Wall shelf unit Smartframe	XL 7.1.11
Crockery cupboards	XL 7.1.12
Crockery cupboards with glass fronts	XL 7.1.12
Tall units Back cladding	XL 7.1.13
Tall units Visible sides / increased side depth	XL 7.1.13
Panel brackets	XL 7.1.14
Panel back walls	XL 7.1.14
Push-fit shelves 50 mm	XL 7.1.15
Push-fit shelves 25 mm	XL 7.1.15
Panel shelves 16 mm	XL 7.1.16
Panel shelves 25 mm	XL 7.1.16
Plinth bases	XL 7.1.16
Living room furniture, special elements	XL 7.1.17
Hall cupboards and coat stands	XL 7.1.18

## Legend:



Available with grip ledge N...



Not available with grip ledge N...



This symbol indicates which models are available



This symbol indicates which models are not available



Planning advice



Merchandise net



Body depth 61 cm



Available carcass depths 34/45.5/55.5/61.0 cm



Available carcass depths 45.5/55.5/61.0 cm

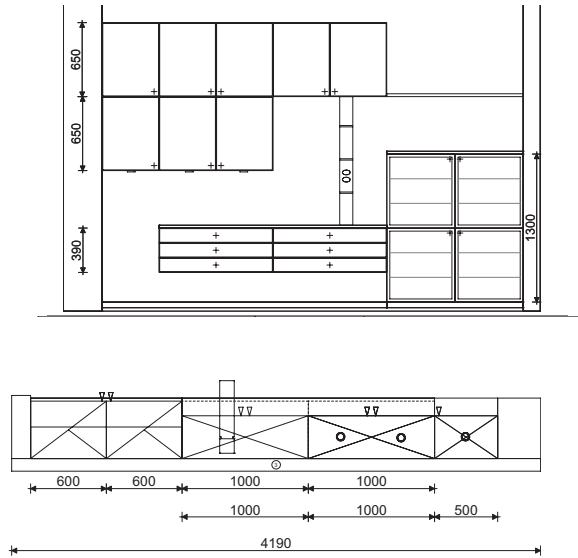


Available carcass depths 55.5/61.0 cm

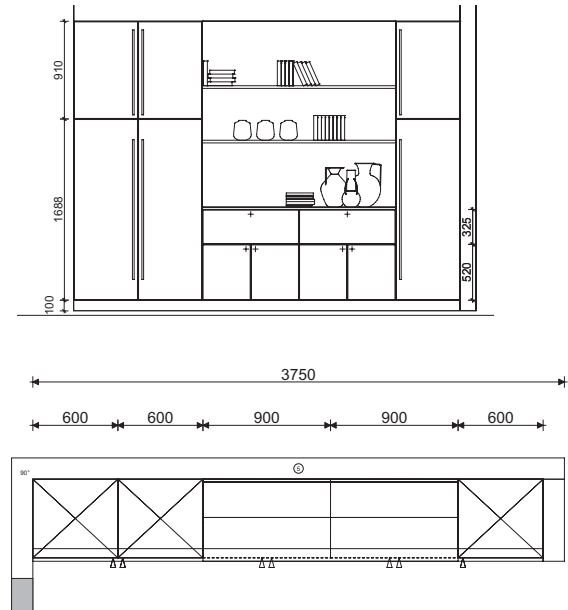


# Homestory

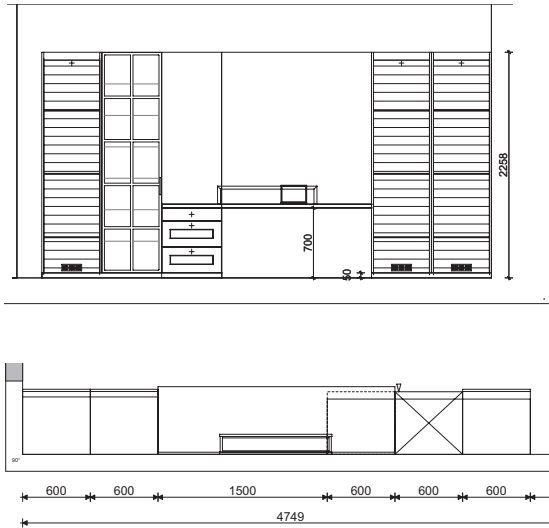
HISTORY H-1001



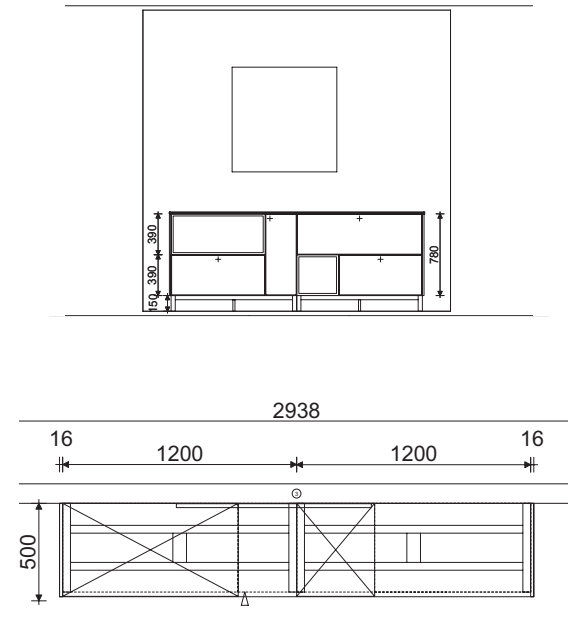
HISTORY H-1002



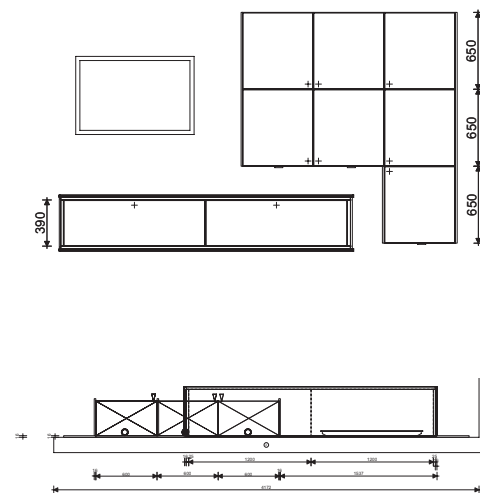
HISTORY H-1003



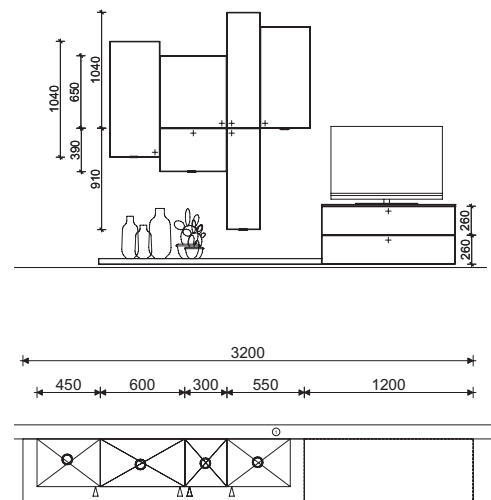
HISTORY H-1004



Hstory H-1005

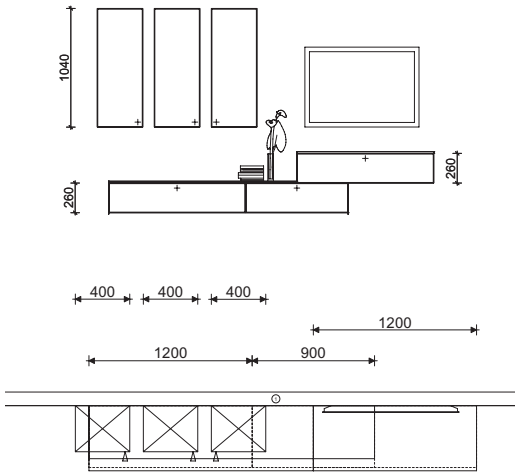


HISTORY H-1006

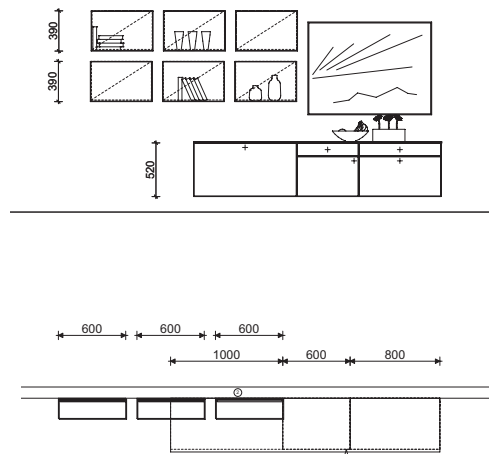


# Homestory

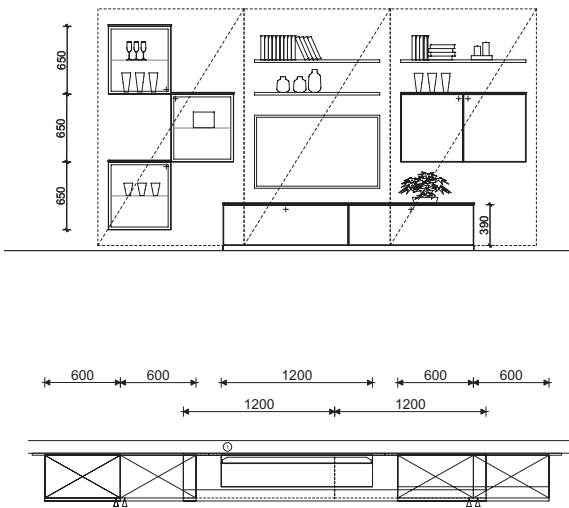
HISTORY H-1007



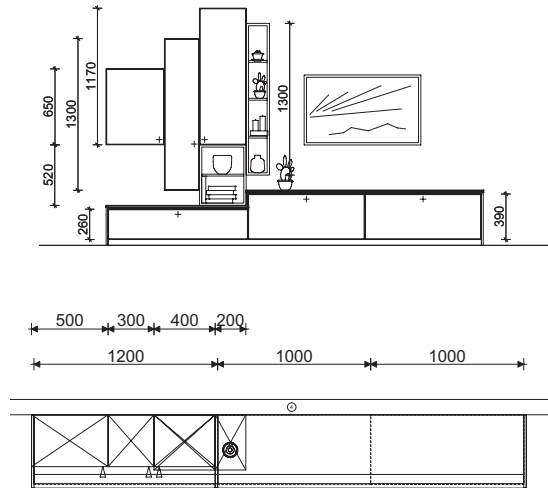
HISTORY H-1008



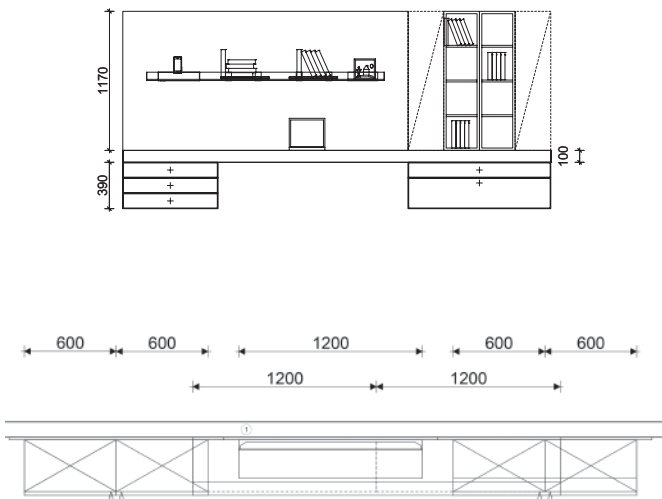
HISTORY H-1009



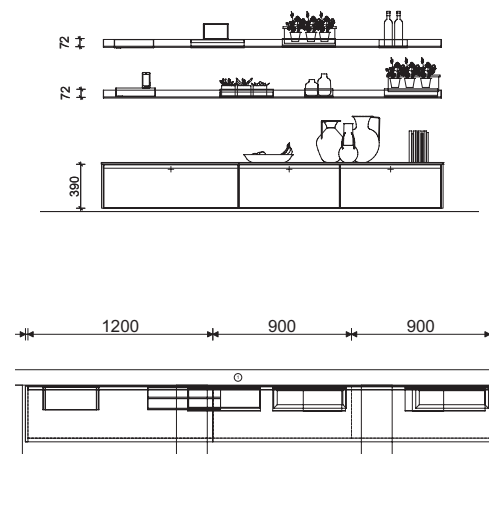
HISTORY H-1010



HISTORY H-1011



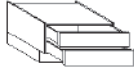

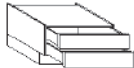



HISTORY H-1012







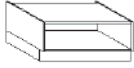

## Base units 26 cm high

Carcase depth 55.5 cm (standard)

						Price groups										
		Order no.		W H D		Hinge side:	Carcase depth	1	2	3	4	5	6	7	8	9
126  Base unit With top shelf 2 drawers 12.6 cm		U	30	26	55	20	■	244	250	267	307	307	315	346	381	-
		U	40	26	55	20	■	244	250	267	307	307	315	346	381	-
		U	45	26	55	20	■	244	250	267	307	307	315	346	381	-
		U	50	26	55	20	■	244	250	267	307	307	315	346	381	-
		U	60	26	55	20	■	260	263	279	325	325	340	371	408	-
		U	80	26	55	20	■	393	401	438	479	484	507	554	609	-
		U	90	26	55	20	■	393	401	438	479	484	507	554	609	-
		U	100	26	55	20	■	413	423	465	506	515	541	588	647	-
126  Base unit With top shelf 2 drawers 12.6 cm Carcase depth 70.5 cm		U	30	26	70	20		381	385	403	440	440	445	477	525	-
		U	40	26	70	20		381	385	403	440	440	445	477	525	-
		U	45	26	70	20		381	385	403	440	440	445	477	525	-
		U	50	26	70	20		381	385	403	440	440	445	477	525	-
		U	60	26	70	20		395	401	417	456	456	472	500	550	-
256  Base unit With top shelf 1 pull-out 25.6 cm		U	30	26	55	01	■	252	255	280	314	314	325	357	393	-
		U	40	26	55	01	■	252	255	280	314	314	325	357	393	-
		U	45	26	55	01	■	252	255	280	314	314	325	357	393	-
		U	50	26	55	01	■	252	255	280	314	314	325	357	393	-
		U	60	26	55	01	■	269	275	302	341	341	360	391	430	-
		U	80	26	55	01	■	431	440	488	540	547	576	633	696	-
		U	90	26	55	01	■	431	440	488	540	547	576	633	696	-
		U	100	26	55	01	■	441	448	500	552	560	594	651	716	-
		U	120	26	55	01	■	448	462	516	566	576	610	668	735	-
Extra charge Plinth blocks screwed per unit		MP-SKV					18,40									
		 <b>Recommendation:</b> For wall-hanging base units: Take into account the extra charge for screw-on plinth blocks <b>MP-SKV</b> We also recommend the screw-on plinth block for plans with panel brackets or plinth bases.														

## Base shelf units 26 cm high

Carcase depth 57.7 cm, flush with front

						Decor groups										
		Order no.		W H D		Hinge side:	Carcase depth	M10	M20	M30	M40	M50	M60	M70	M80	M90
 Base shelf unit wide in cm: 13-30 wide in cm: 30,1-40 wide in cm: 40,1-45 wide in cm: 45,1-50 wide in cm: 50,1-60		UR	30	26	58	■	154	-	-	-	532	-	532	532	-	
		UR	40	26	58	■	154	-	-	-	532	-	532	532	-	
		UR	45	26	58	■	154	-	-	-	532	-	532	532	-	
		UR	50	26	58	■	154	-	-	-	532	-	532	532	-	
		UR	60	26	58	■	154	-	-	-	532	-	532	532	-	
		 Base shelf unit wide in cm: 60,1-80 wide in cm: 80,1-90		UR	80	26	58	■	171	-	-	-	602	-	602	777
UR	90			26	58	■	171	-	-	-	602	-	602	777	-	

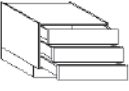
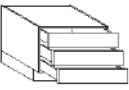
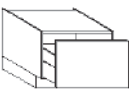
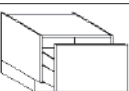

M 10	M 20	M 30	M 40	M 50
K M10 laminate				B M50 Velvet lacquer S M50 microstructure lacquer
M 60	M 70	M 80	M 90	
	F M70 veneer / oak / walnut Z M70 Veneer / Bavaria	H M80 high gloss-Lacquer MP M80 laqué mat Premium		

**Recommendation:** For wall-hanging base units:  
 Take into account the extra charge for screw-on plinth blocks **MP-SKV**  
 We also recommend the screw-on plinth block for plans with panel brackets or plinth bases.

## Base units 39 cm high

Carcase depth 55.5 cm (standard)

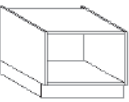
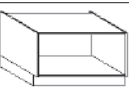
■ = Models also available in 34/45.5/61 cm carcass depth (Order no.: ... replace ... 55 ... with 34/45/61)

	Order no. W H D	Hinge side: Carcass depth	Price groups								
			1	2	3	4	5	6	7	8	9
 <p><b>Base unit</b> With top shelf 3 drawers 12.6 cm</p>	U 30 39 55 30	■	360	367	393	453	453	467	508	559	-
	U 40 39 55 30	■	360	367	393	453	453	467	508	559	-
	U 45 39 55 30	■	360	367	393	453	453	467	508	559	-
	U 50 39 55 30	■	360	367	393	453	453	467	508	559	-
	U 60 39 55 30	■	381	390	414	481	481	498	549	604	-
	U 70 39 55 30	■	578	588	647	703	713	746	815	897	-
	U 80 39 55 30	■	578	588	647	703	713	746	815	897	-
	U 90 39 55 30	■	578	588	647	703	713	746	815	897	-
	U 100 39 55 30	■	610	624	688	746	758	794	867	954	-
	U 120 39 55 30	■	639	657	728	790	800	846	923	1015	-
Width 30, 40, 45, 50, 60, 80, 90, 100, 120 Width 70 Not available for: ALUELEMENTS, MIAMI, STRIP ELEMENTS, VIVA											
 <p><b>Base unit</b> With top shelf 3 drawers 12.6 cm Carcass depth 70.5 cm</p>	U 30 39 70 30	■	563	569	594	649	649	658	700	770	-
	U 40 39 70 30	■	563	569	594	649	649	658	700	770	-
	U 45 39 70 30	■	563	569	594	649	649	658	700	770	-
	U 50 39 70 30	■	563	569	594	649	649	658	700	770	-
	U 60 39 70 30	■	580	588	615	675	675	693	739	813	-
 <p><b>Base unit</b> With top shelf 1 pull-out 38.6 cm</p>	U 30 39 55 01	■	252	255	280	314	314	325	357	393	-
	U 40 39 55 01	■	252	255	280	314	314	325	357	393	-
	U 45 39 55 01	■	252	255	280	314	314	325	357	393	-
	U 50 39 55 01	■	252	255	280	314	314	325	357	393	-
	U 60 39 55 01	■	269	275	302	341	341	360	391	430	-
	U 70 39 55 01	■	431	440	488	540	547	576	633	696	-
	U 80 39 55 01	■	431	440	488	540	547	576	633	696	-
	U 90 39 55 01	■	431	440	488	540	547	576	633	696	-
	U 100 39 55 01	■	441	448	500	552	560	594	651	716	-
	U 120 39 55 01	■	448	462	516	566	576	610	668	735	-
Width 30, 40, 45, 50, 60, 80, 90, 100, 120 Width 70 Not available for: ALUELEMENTS, MIAMI, STRIP ELEMENTS, VIVA											
 <p><b>Base unit</b> With top shelf 1 pull-out 38.6 cm Carcass depth 70.5 cm</p>	U 30 39 70 01	■	354	357	385	412	412	423	451	496	-
	U 40 39 70 01	■	354	357	385	412	412	423	451	496	-
	U 45 39 70 01	■	354	357	385	412	412	423	451	496	-
	U 50 39 70 01	■	354	357	385	412	412	423	451	496	-
	U 60 39 70 01	■	370	374	403	440	440	456	488	537	-
	U 70 39 70 01	■	528	536	583	630	640	667	723	795	-
	U 80 39 70 01	■	528	536	583	630	640	667	723	795	-
	U 90 39 70 01	■	528	536	583	630	640	667	723	795	-
	U 100 39 70 01	■	536	549	598	646	653	686	740	814	-
	U 120 39 70 01	■	547	561	610	658	667	700	760	836	-
Width 30, 40, 45, 50, 60, 80, 90, 100, 120 Width 70 Not available for: ALUELEMENTS, MIAMI, STRIP ELEMENTS, VIVA											
<b>Extra charge Plinth blocks screwed per unit</b>		MP-SKV	18,40								
		 <b>Recommendation:</b> For wall-hanging base units: Take into account the extra charge for screw-on plinth blocks MP-SKV We also recommend the screw-on plinth block for plans with panel brackets or plinth bases.									

## Base shelf units 39 cm high

Carcass depth 57.7 cm, flush with front

■ = Models also available in 36.1/47.7/63.2 cm carcass depth (Order no.: replace ... 58 ... with 36/48/63)

 <p>wide in cm: 13-30 wide in cm: 30,1-40 wide in cm: 40,1-45 wide in cm: 45,1-50 wide in cm: 50,1-60</p>	UR 30 39 58	■	154	-	-	-	532	-	532	532	-
	UR 40 39 58	■	154	-	-	-	532	-	532	532	-
	UR 45 39 58	■	154	-	-	-	532	-	532	532	-
	UR 50 39 58	■	154	-	-	-	532	-	532	532	-
	UR 60 39 58	■	154	-	-	-	532	-	532	532	-
 <p>wide in cm: 60,1-80 wide in cm: 80,1-90</p>	UR 80 39 58	■	171	-	-	-	602	-	602	777	-
	UR 90 39 58	■	171	-	-	-	602	-	602	777	-
<b>M 10</b>	<b>M 20</b>	<b>M 30</b>	<b>M 40</b>	<b>M 50</b>							
K M10 laminate				B M50 Velvet lacquer S M50 microstructure lacquer							
<b>M 60</b>	<b>M 70</b>	<b>M 80</b>	<b>M 90</b>								
	F M70 veneer / oak / walnut Z M70 Veneer / Bavaria	H M80 high gloss-Lacquer MP M80 laqué mat Premium									

# Base units 78 cm high

Carcase depth 55.5 cm (standard)

								Price groups												
				Order no.		Hinge side:	Carcase depth													
				W	H			D	1	2	3	4	5	6	7	8	9			
776		<b>Base unit</b> 1 door 77.6 cm 2 adjustable shelves	34,0 45,5 55,5 61,0	U	20	78	55	70	R/L	■	182	191	214	264	284	299	329	362	-	
				U	25	78	55	70	R/L	■	182	191	214	264	284	299	329	362	-	
				U	30	78	55	70	R/L	■	182	191	214	264	284	299	329	362	-	
				U	40	78	55	70	R/L	■	182	191	214	271	284	303	332	365	-	
				U	45	78	55	70	R/L	■	182	191	214	271	284	303	332	365	-	
				U	50	78	55	70	R/L	■	182	191	214	271	303	325	364	400	-	
				U	60	78	55	70	R/L	■	215	227	245	308	354	377	419	461	-	
width 20 cm: <i>FRAME, VILLAGE 15-S, VILLAGE 15-B, CHALET-S, CHALET-B, OSLO 15, TESSIN 15, BERGEN, LUGANO, CASTELLO, VIVA, TIM 15</i> are supplied with smooth fronts. width 25 cm: <i>FRAME</i> are supplied with smooth fronts.																				
776		<b>Base unit</b> 2 doors 77.6 cm 2 adjustable shelves	34,0 45,5 55,5 61,0	U	80	78	55	70			■	244	253	282	407	490	532	598	658	-
				U	90	78	55	70			■	244	253	282	407	490	532	599	659	-
				U	100	78	55	70			■	255	267	300	430	490	532	601	661	-
				U	120	78	55	70			■	295	312	359	508	581	628	708	779	-
126 126 126 126 126		<b>Base unit</b> 6 drawers 12.6 cm	34,0 45,5 55,5 61,0	U	30	78	55	50			■	643	652	692	783	783	800	863	949	-
				U	40	78	55	50			■	643	652	692	783	783	800	863	949	-
				U	45	78	55	50			■	643	652	692	783	783	800	863	949	-
				U	50	78	55	50			■	643	652	692	783	783	800	863	949	-
				U	60	78	55	50			■	677	687	722	823	823	853	923	1015	-
				U	70	78	55	50			■	991	1005	1092	1173	1188	1239	1341	1475	-
				U	80	78	55	50			■	991	1005	1092	1173	1188	1239	1341	1475	-
				U	90	78	55	50			■	991	1005	1092	1173	1188	1239	1341	1475	-
				U	100	78	55	50			■	1044	1070	1165	1251	1267	1324	1434	1577	-
				Width 30, 40, 45, 50, 60, 80, 90, 100 Width 70 Not available for: <i>ALUELEMENTS, MIAMI, STRIP ELEMENTS, VIVA</i>																
256 256 256		<b>Base unit</b> 3 pull-outs 25.6 cm	34,0 45,5 55,5 61,0	U	30	78	55	03			■	515	523	570	621	621	644	695	765	-
				U	40	78	55	03			■	515	523	570	621	621	644	695	765	-
				U	45	78	55	03			■	515	523	570	621	621	644	695	765	-
				U	50	78	55	03			■	515	523	570	621	621	644	695	765	-
				U	60	78	55	03			■	546	555	599	667	667	700	756	832	-
				U	70	78	55	03			■	826	841	925	1011	1025	1077	1176	1294	-
				U	80	78	55	03			■	826	841	925	1011	1025	1077	1176	1294	-
				U	90	78	55	03			■	826	841	925	1011	1025	1077	1176	1294	-
				U	100	78	55	03			■	851	869	962	1047	1063	1117	1222	1344	-
				U	120	78	55	03			■	879	900	995	1085	1098	1160	1269	1396	-
Width 30, 40, 45, 50, 60, 80, 90, 100, 120 Width 70 Not available for: <i>ALUELEMENTS, MIAMI, STRIP ELEMENTS, VIVA</i>																				
256 256 256		<b>Base unit</b> 3 pull-outs 25.6 cm Carcase depth 70.5 cm	34,0 45,5 55,5 61,0	U	30	78	70	03				700	710	758	800	800	823	869	956	-
				U	40	78	70	03				700	710	758	800	800	823	869	956	-
				U	45	78	70	03				700	710	758	800	800	823	869	956	-
				U	50	78	70	03				700	710	758	800	800	823	869	956	-
				U	60	78	70	03				731	738	788	849	849	873	929	1022	-
				U	70	78	70	03				1002	1017	1096	1173	1188	1239	1335	1469	-
				U	80	78	70	03				1002	1017	1096	1173	1188	1239	1335	1469	-
				U	90	78	70	03				1002	1017	1096	1173	1188	1239	1335	1469	-
				U	100	78	70	03				1026	1046	1131	1212	1226	1280	1382	1520	-
				U	120	78	70	03				1050	1078	1165	1250	1264	1323	1427	1570	-
Width 30, 40, 45, 50, 60, 80, 90, 100, 120 Width 70 Not available for: <i>ALUELEMENTS, MIAMI, STRIP ELEMENTS, VIVA</i>																				

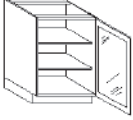
# Base units with glass fronts

Carcase depth 55.5 cm (standard)

Order no. W H D

■ = Models also available in 34/45.5/61 cm carcass depth (Order no.: ... replace ... 55 ... with 34/45/61)

776



**Base unit with glass door**  
-neutral-  
1 AktivGlas door 77.6 cm  
with „push to open“ fitting  
2 adjustable glass shelves

34.0  
45.5  
55.5  
61.0

AKTIV  
GLAS

UGDA 45 78 55  
UGDA 50 78 55  
UGDA 60 78 55

Hinge side:  
Carcass depth

Glass groups					
G1	G2	G2S	G5S	G6	
■					

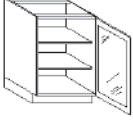
R/L ■  
R/L ■  
R/L ■

446 - - - -  
451 - - - -  
484 - - - -



**Planning advice:**  
Without drill hole for handle, knobs/handles not possible  
with „push to open“ fitting.  
For carcass depth 34 cm with wall mounting.

776



**Base unit with glass front**  
-neutral-  
1 glass door 77.6 cm  
2 adjustable glass shelves

34.0  
45.5  
55.5  
61.0

UGD 45 78 55  
UGD 50 78 55  
UGD 60 78 55

R/L ■  
R/L ■  
R/L ■

- 527 527 604 911  
- 547 547 620 931  
- 596 596 675 980





**Note:**  
For carcass depth 34 cm with wall mounting.

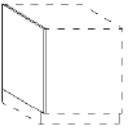

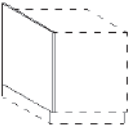

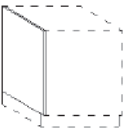

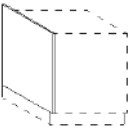

G 1	G 2	G 2S
<b>G1 AKTIVglass frame</b> 991 Matt glass 992 Translucent black glass	<b>G2 Design front</b> 925 Frame White Agate/Matt glass 935 Premium W. Frame/Matt Glass 940 Macaron Col. Frame/Matt Glass 95 Light grey frame/matt glass 96 Silver Col. Frame/Matt Glass 960 Snow White Frame/Matt Glass 97 Black frame/black glass	<b>G2S aluminium, framed glass door</b> 988 aluminium black, Linea glass 994 Aluminium frame/clear glass 995 aluminium frame/black glass

G 5	G 5S	G 6
	<b>G5S aluminium, door with mullion</b> 996 Alum.frame/clear gl./cross bar	<b>G6 NEW SALON</b> 986 aluminium black, black glass 987 aluminium black, clear glass 989 aluminium matt, bronze-coloured black glass 990 aluminium matt, bronze-coloured clear glass

## Base units Back cladding

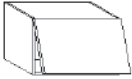
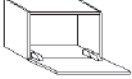



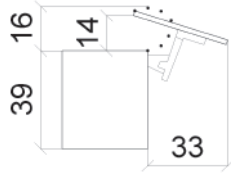
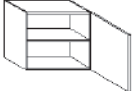
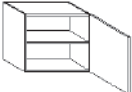
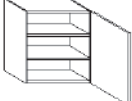
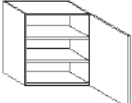
		Order no.		Decor groups										
		W H D		Hinge side:	Carcass depth	M10	M20	M30	M40	M50	M60	M70	M80	M90
	<b>Back cladding</b> With suspension fittings for base units, 26 cm high 16 mm thick	per 10 cm Width												
		<b>UVK 26</b>				8,90	15,50	32	42	42	42	42	42	42
	<b>Back cladding</b> With suspension fittings for base units, 39 cm high 16 mm thick	per 10 cm Width												
		<b>UVK 39</b>				8,90	15,50	32	42	42	42	42	42	42
<b>M 10</b>	<b>M 20</b>	<b>M 30</b>	<b>M 40</b>	<b>M 50</b>										
K M10 laminate	D M20 Laminate decor	I M30 RESOPAL PRO super matt IH M30 HPL PRO PW M30 PRIMEWOOD/Basic Veneer	A M40 DIRECTLACK matt L M40 DIRECTLACK high-gloss	B M50 Velvet lacquer S M50 microstructure lacquer										
<b>M 60</b>	<b>M 70</b>	<b>M 80</b>	<b>M 90</b>											
QH M60 SMARTGLAS high-gloss QM M60 SMARTGLAS satin-finish	F M70 veneer / oak / walnut Z M70 Veneer / Bavaria	C1 M80 FENIX stainless-steel look H M80 high gloss-Lacquer MP M80 laqué mat Premium												

## Base units Visible sides / increased side depth

	<b>Base unit visible side</b>  55.5 cm side depth Fixed dimension, not variable	 <b>Important!</b> Installation instead of a normal unit side. Only available in the listed side depths. For other dimensions, use USVT...											
		<b>USV 26</b>	R/L	0	0	63	63	83	83	94	123	-	
	<b>Base unit increased side depth</b> Up to 90 cm side depth	 <b>Important!</b> Installation instead of a normal unit side.											
		<b>USVT 26</b>	R/L	59	72	135	135	179	179	206	264	-	
	<b>Base unit visible side</b>  55.5 cm side depth Fixed dimension, not variable 57.5 cm side depth Fixed dimension, not variable 60.5 cm side depth Fixed dimension, not variable 61 cm side depth Fixed dimension, not variable 70.5 cm side depth Fixed dimension, not variable	 <b>Important!</b> Installation instead of a normal unit side. Only available in the listed side depths. For other dimensions, use USVT...											
		<b>USV 39</b>	R/L	0	0	63	63	83	83	94	123	-	
		<b>USV 39 5</b>	R/L	0	0	63	63	83	83	94	123	-	
		<b>USV 39 6</b>	R/L	0	0	63	63	83	83	94	123	-	
		<b>USV 39 6 1</b>	R/L	0	0	63	63	83	83	94	123	-	
		<b>USV 39 7</b>	R/L	0	0	63	63	83	83	94	123	-	
	<b>Base unit increased side depth</b>  from 61.1 cm up to 90 cm side depth Up to 60.9 cm side depth	 <b>Important!</b> Installation instead of a normal unit side.											
		<b>USVT 39</b>	R/L	59	72	135	135	179	179	206	264	-	
		<b>USVT 39 6</b>	R/L	32	35	89	89	119	119	138	180	-	
<b>M 10</b>	<b>M 20</b>	<b>M 30</b>	<b>M 40</b>	<b>M 50</b>									
K M10 laminate	D M20 Laminate decor	I M30 RESOPAL PRO super matt IH M30 HPL PRO PW M30 PRIMEWOOD/Basic Veneer	A M40 DIRECTLACK matt L M40 DIRECTLACK high-gloss	B M50 Velvet lacquer P M50 Soft lacquer RH M50 Velvet lacquer wood texture RW M50 Velvet lacquer spackle effect S M50 microstructure lacquer									
<b>M 60</b>	<b>M 70</b>	<b>M 80</b>	<b>M 90</b>										
QH M60 SMARTGLAS high-gloss QM M60 SMARTGLAS satin-finish	F M70 veneer / oak / walnut V M70 Velvet lacquer textured Z M70 Veneer / Bavaria	C1 M80 FENIX stainless-steel look H M80 high gloss-Lacquer MP M80 laqué mat Premium O M80 Veneered											



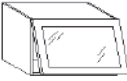



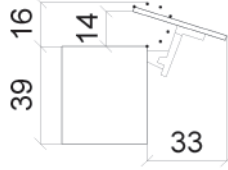


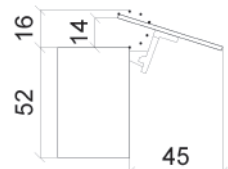


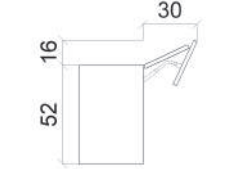
# Wall units Carcase height 39 cm, 52 cm and 65 cm

Carcase depth 34 cm

	Order no.	W	H	D	Hinge side:	Carcase depth	Price groups									
							1	2	3	4	5	6	7	8	9	
 <p><b>Wall unit</b> 1 flap door 38.6 cm</p> <p>Carcase height 39 cm</p>		H	30	39	34	78		236	242	264	301	317	326	334	367	-
		H	40	39	34	78		236	242	264	301	317	326	346	381	-
		H	45	39	34	78		236	242	264	301	317	326	346	381	-
		H	50	39	34	78		237	242	264	301	323	331	355	391	-
		H	60	39	34	78		244	250	271	312	330	341	366	403	-
		H	80	39	34	78		246	251	276	329	349	366	402	442	-
		H	90	39	34	78		246	251	276	329	349	366	402	442	-
		H	100	39	34	78		253	260	288	341	363	377	416	458	-
		H	120	39	34	78		261	270	300	356	373	393	432	475	-
 <p><b>Wall unit with bar flap</b> 1 bar flap 38.6 cm</p> <p>Carcase height 39 cm</p>		HB	45	39	34		391	396	419	448	467	477	494	543	-	
		HB	50	39	34		392	396	419	448	473	481	501	551	-	
		HB	60	39	34		398	402	423	462	479	491	515	567	-	
		HB	80	39	34		467	477	499	546	601	617	652	717	-	
		HB	90	39	34		467	477	499	546	601	617	652	717	-	
		HB	100	39	34		484	491	519	565	620	638	674	741	-	
 <p>Up to a front height of 40 cm, the flap door can be loaded with 20 kg including front weight</p>																
 <p><b>Wall unit</b> 1 front 38.6 cm with lift-up fitting</p> <p>Carcase height 39 cm</p>		HL	45	39	34	78	325	331	355	392	403	419	441	485	-	
		HL	50	39	34	78	325	331	355	392	410	423	444	488	-	
		HL	60	39	34	78	330	338	360	398	414	427	448	493	-	
		HL	80	39	34	78	403	410	435	483	536	554	587	646	-	
		HL	90	39	34	78	403	410	435	483	536	554	587	646	-	
		HL	100	39	34	78	414	420	444	494	550	568	604	664	-	
 <p>Do not plan in conjunction with cornices and top covers! Please observe a minimum distance of 17.5 cm between the top edge of the unit and the ceiling.</p>																
																
 <p><b>Wall unit</b> 1 door 51.6 cm 1 adjustable shelf</p> <p>Carcase height 52 cm</p>		H	30	52	34	70	R/L	125	133	146	182	208	217	236	260	-
		H	40	52	34	70	R/L	125	133	146	182	208	217	236	260	-
		H	45	52	34	70	R/L	125	133	146	182	211	222	245	270	-
		H	50	52	34	70	R/L	125	133	146	182	216	227	251	276	-
		H	60	52	34	70	R/L	141	147	166	220	254	263	294	323	-
		H	70	52	34	70	R/L	172	182	188	319	363	377	416	458	-
 <p><b>Wall unit</b> 1 door 51.6 cm 1 adjustable shelf Drill hole for handle at top</p> <p>Carcase height 52 cm</p>		HU	30	52	34	70	R/L	125	133	146	182	208	217	236	260	-
		HU	40	52	34	70	R/L	125	133	146	182	208	217	236	260	-
		HU	45	52	34	70	R/L	125	133	146	182	211	222	245	270	-
		HU	50	52	34	70	R/L	125	133	146	182	216	227	251	276	-
		HU	60	52	34	70	R/L	141	147	166	220	254	263	294	323	-
 <p><b>Wall unit</b> 1 door 64.6 cm 2 adjustable shelves</p> <p>Carcase height 65 cm</p>		H	30	65	34	70	R/L	128	136	147	186	202	204	218	240	-
		H	40	65	34	70	R/L	145	149	172	211	233	246	268	295	-
		H	45	65	34	70	R/L	145	149	172	211	233	246	268	295	-
		H	50	65	34	70	R/L	156	164	183	226	252	263	293	322	-
		H	60	65	34	70	R/L	175	187	208	262	298	301	332	365	-
		H	70	65	34	70	R/L	191	205	245	343	393	412	451	496	-
 <p><b>Wall unit</b> 1 door 64.6 cm 2 adjustable shelves Drill hole for handle at top</p> <p>Carcase height 65 cm</p>		HU	30	65	34	70	R/L	128	136	147	186	202	204	218	240	-
		HU	40	65	34	70	R/L	145	149	172	211	233	246	268	295	-
		HU	45	65	34	70	R/L	145	149	172	211	233	246	268	295	-
		HU	50	65	34	70	R/L	156	164	183	226	252	263	293	322	-
		HU	60	65	34	70	R/L	175	187	208	262	298	301	332	365	-

# Wall units with glass fronts Carcase height 39 cm, 52 cm and 65 cm


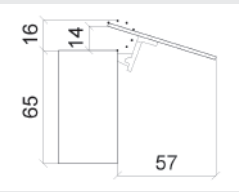
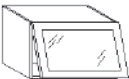
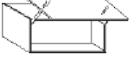
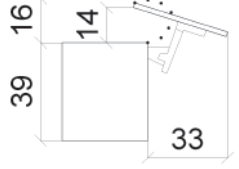
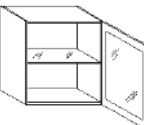
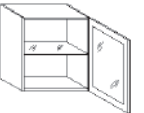
Carcase depth 34 cm

		Glass groups					
		G1	G2	G2S	G5S	G6	
	Order no. W H D						
256  Wall unit with glass front -neutral- 1 flap door with AktivGlas front 25.6 cm	AKTIV GLAS	HGDA 60 26 34 78	423	-	-	-	-
		HGDA 80 26 34 78	461	-	-	-	-
		HGDA 90 26 34 78	474	-	-	-	-
		HGDA100 26 34 78	478	-	-	-	-
		 with grip ledge in bottom shelf Without drill hole for handle, knobs/handles not possible					
386  Wall unit with glass front -neutral- 1 flap door with AktivGlas front 38.6 cm	AKTIV GLAS	HGDA 60 39 34 78	425	-	-	-	-
		HGDA 80 39 34 78	467	-	-	-	-
		HGDA 90 39 34 78	477	-	-	-	-
		HGDA100 39 34 78	499	-	-	-	-
		 Without drill hole for handle, knobs/handles not possible with grip ledge in bottom shelf					
386  Wall unit -neutral- 1 AktivGlas front 38.6 cm with lift-up fitting	AKTIV GLAS	HGLDA60 39 34	519	-	-	-	-
		HGLDA80 39 34	652	-	-	-	-
		HGLDA90 39 34	652	-	-	-	-
		HGLDA100 39 34	675	-	-	-	-
		 Without drill hole for handle, knobs/handles not possible with grip ledge in bottom shelf Do not plan in conjunction with cornices or top covers. Please observe a minimum distance of 17.5 cm between the top edge of the unit and the ceiling.					
							
516  Wall unit -neutral- 1 AktivGlas front 51.6 cm with lift-up fitting 1 adjustable glass shelf	AKTIV GLAS	HGLDA60 52 34	517	-	-	-	-
		HGLDA80 52 34	585	-	-	-	-
		HGLDA90 52 34	585	-	-	-	-
		HGLDA100 52 34	598	-	-	-	-
		 Without drill hole for handle, knobs/handles not possible with grip ledge in bottom shelf Do not plan in conjunction with cornices and top covers! Please observe a minimum distance of 17.5 cm between the top edge of the unit and the ceiling.					
							
256  Wall unit -neutral- 1 folding-lifting door with AktivGlas front 25.6 cm at top and AktiveGlas front 25.6 cm at bottom 1 adjustable glass shelf	AKTIV GLAS	HFLDA60 52 34	581	-	-	-	-
		HFLDA80 52 34	596	-	-	-	-
		HFLDA90 52 34	596	-	-	-	-
		HFLDA100 52 34	628	-	-	-	-
		 Without drill hole for handle, knobs/handles not possible with grip ledge in bottom shelf					
							

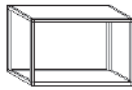
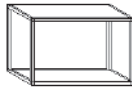
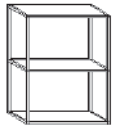

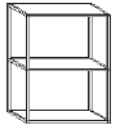



# Wall units with glass fronts Carcase height 39 cm, 52 cm and 65 cm

Carcase depth 34 cm

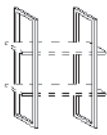

		Order no.		Hinge side:	Carcase depth	Glass groups							
		W	H			D	G1	G2	G2S	G5S	G6		
516	 <p><b>Wall unit</b> 1 AktivGlas front 51.6 cm with lift-up fitting -neutral- 1 adjustable glass shelf</p>	AKTIV GLAS	HGLDA60	65	34		560	-	-	-	-		
			HGLDA80	65	34		585	-	-	-	-		
			HGLDA90	65	34		585	-	-	-	-		
			HGLDA100	65	34		598	-	-	-	-		
			 <p>Without drill hole for handle, knobs/handles not possible with grip ledge in bottom shelf Do not plan in conjunction with cornices or top covers. Please observe a minimum distance of 17.5 cm between the top edge of the unit and the ceiling.</p>										
386	 <p><b>Wall unit with glass front</b> -neutral- 1 flap door 38.6 cm with glass front</p>		HGD	45	39	34	78	-	515	-	-	-	
			HGD	50	39	34	78	-	518	-	-	-	
			HGD	60	39	34	78	-	541	-	-	-	
			HGD	80	39	34	78	-	606	-	-	-	
			HGD	90	39	34	78	-	628	-	-	-	
			HGD	100	39	34	78	-	652	-	-	-	
			HGD	120	39	34	78	-	697	-	-	-	
386	 <p><b>Wall unit</b> -neutral- 1 glass front 38.6 cm with lift-up fitting</p>		HGLD	45	39	34		-	602	-	-	-	
			HGLD	50	39	34		-	605	-	-	-	
			HGLD	60	39	34		-	628	-	-	-	
			HGLD	80	39	34		-	789	-	-	-	
			HGLD	90	39	34		-	797	-	-	-	
			HGLD100	39	34		-	826	-	-	-		
		 <p>Do not plan in conjunction with cornices or top covers. Please observe a minimum distance of 17.5 cm between the top edge of the unit and the ceiling.</p>											
646	 <p><b>Wall unit with glass door</b> -neutral- 1 glass door 64.6 cm 1 adjustable glass shelf</p>		HGD	45	65	34	70	R/L	-	442	442	499	826
			HGD	50	65	34	70	R/L	-	473	473	530	857
			HGD	60	65	34	70	R/L	-	515	515	587	899
646	 <p><b>Wall unit with glass front</b> 1 glass door 64.6 cm 1 adjustable glass shelf Drill hole for handle at top</p>		HGUD	45	65	34		R/L	-	442	-	-	-
			HGUD	50	65	34		R/L	-	473	-	-	-
			HGUD	60	65	34		R/L	-	515	-	-	-
<b>G1</b>		<b>G2</b>		<b>G2S</b>									
<b>G1 AKTIVglass frame</b> 991 Matt glass 992 Translucent black glass		<b>G2 Design front</b> 925 Frame White Agate/Matt glass 935 Premium W. Frame/Matt Glass 940 Macaron Col. Frame/Matt Glass 95 Light grey frame/matt glass 96 Silver Col. Frame/Matt Glass 960 Snow White Frame/Matt Glass 97 Black frame/black glass		<b>G2S aluminium, framed glass door</b> 988 aluminium black, Linea glass 994 Aluminium frame/clear glass 995 aluminium frame/black glass									
<b>G5</b>		<b>G5S</b>		<b>G6</b>									
		<b>G5S aluminium, door with mullion</b> 996 Alum.frame/clear gl./cross bar		<b>G6 NEW SALON</b> 986 aluminium black, black glass 987 aluminium black, clear glass 989 aluminium matt, bronze-coloured black glass 990 aluminium matt, bronze-coloured clear glass									

# Wall shelf unit Smart Cube

			Order no. W H D	Hinge side: Carcase depth	Decor groups								
					M10	M20	M30	M40	M50	M60	M70	M80	M90
 <p><b>Wall shelf unit Smart Cube</b> for hanging Finish: metal stainless steel-coloured Dimensions: height 39 cm, depth 25 cm Incl. 2 shelves 1.6 cm thick</p> <p><i>Carcase height 39 cm</i></p> <p>60 cm wide 90 cm wide 120 cm wide</p>			<b>HRDM 60 39 25</b>		391	410	-	-	498	-	553	-	-
			<b>HRDM 90 39 25</b>		439	466	-	-	599	-	705	-	-
			<b>HRDM120 39 25</b>		474	511	-	-	692	-	805	-	-
 <p><b>Wall shelf unit Smart Cube</b> for hanging Finish: aluminium black Dimensions: height 39 cm, depth 25 cm Incl. 2 shelves 1.6 cm thick</p> <p><i>Carcase height 39 cm</i></p> <p>60 cm wide 90 cm wide 120 cm wide</p>			<b>HRDS 60 39 25</b>		391	410	-	-	498	-	553	-	-
			<b>HRDS 90 39 25</b>		439	466	-	-	599	-	705	-	-
			<b>HRDS120 39 25</b>		474	511	-	-	692	-	805	-	-
 <p><b>Wall shelf unit Smart Cube</b> for hanging Finish: metal stainless steel-coloured consisting of: 4 Smart Cube connecting elements 6 lengthways profile 2 side elements 3 shelves 1.6 cm thick height 78 cm depth 25 cm</p> <p><i>Carcase height 78 cm</i></p> <p>60 cm wide 90 cm wide 120 cm wide</p>			 <b>Planning advice:</b> please do not plan the 78 cm height Smart Cube wall shelf units at the same height as the 39 cm height Smart Cube wall shelf units.										
			<b>HRDM 60 78 25</b>		626	654	-	-	784	-	864	-	-
			<b>HRDM 90 78 25</b>		697	736	-	-	931	-	1054	-	-
 <p><b>Wall shelf unit Smart Cube</b> for hanging Finish: aluminium black consisting of: 4 Smart Cube connecting elements 6 lengthways profile 2 side elements 3 shelves 1.6 cm thick height 78 cm depth 25 cm</p> <p><i>Carcase height 78 cm</i></p> <p>60 cm wide 90 cm wide 120 cm wide</p>			 <b>Planning advice:</b> please do not plan the 78 cm height Smart Cube wall shelf units at the same height as the 39 cm height Smart Cube wall shelf units.										
			<b>HRDS 60 78 25</b>		626	654	-	-	784	-	864	-	-
			<b>HRDS 90 78 25</b>		697	736	-	-	931	-	1054	-	-
		<b>HRDS120 78 25</b>		745	799	-	-	1059	-	1220	-	-	
<b>M 10</b>	<b>M 20</b>	<b>M 30</b>	<b>M 40</b>	<b>M 50</b>									
K M10 laminate	D M20 Laminate decor			B M50 Velvet Lacquer S M50 Microstructure Lacquer									
<b>M 60</b>	<b>M 70</b>	<b>M 80</b>	<b>M 90</b>										
	F M70 veneer / oak / walnut												



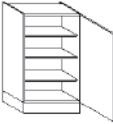
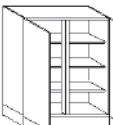



# Wall shelf unit Smartframe

			Order no. W H D	Hinge side: Carcase depth	Decor groups								
					1								
 <p><b>Wall shelf unit Smartframe for hanging</b> Finish: metal, anthracite Mounted for 2 shelves, incl. shelf supports Dimensions: height 78 cm, depth 25 cm 1 set = 2 wall shelf units</p> <p>Finish: stainless steel-coloured Finish: black</p>			 <b>Recommendation:</b> plan one Smartframe wall shelf unit every 60 cm <b>Please order shelves separately</b> <b>Shelf depth: 21.2 cm</b> For shelves, see section: Panels, stiles										
			<b>HRSFM78 25</b>			234							
			<b>HRSF 78 25</b>			234							

## Crockery cupboards



Carcase height 91 cm, 130 cm carcass depth 34 cm,  
Carcase height 130 cm, carcass depth 55.5 cm (standard)

■ = Models also available in 34/45.5/61 cm carcass depth (Order no.: ... replace ... 55 ... with 34/45/61)

		Order no.			Hinge side:	Carcass depth	Price groups								
		W	H	D			1	2	3	4	5	6	7	8	9
 <p><b>Base unit</b> 1 door 90.6 cm 3 adjustable shelves with wall mounting</p>		<b>U 20 91 34 70</b>	R/L		191	199	224	281	299	312	347	382	-		
		<b>U 25 91 34 70</b>	R/L		191	199	224	281	299	312	347	382	-		
		<b>U 30 91 34 70</b>	R/L		191	199	224	281	299	312	347	382	-		
		<b>U 40 91 34 70</b>	R/L		191	199	224	287	299	320	352	387	-		
		<b>U 45 91 34 70</b>	R/L		191	199	224	287	299	320	352	387	-		
		<b>U 50 91 34 70</b>	R/L		191	199	224	287	320	341	377	415	-		
 <p><b>Base unit</b> 2 doors 90.6 cm 3 adjustable shelves with wall mounting</p>		<b>U 80 91 34 70</b>			278	294	312	431	478	506	549	604	-		
		<b>U 90 91 34 70</b>			278	294	312	431	478	506	549	604	-		
		<b>U 100 91 34 70</b>			307	319	340	456	501	534	573	630	-		
 <p><b>Base unit with folding door</b> 1 sliding-folding door, 2-part, 90.6 cm 3 adjustable shelves with wall mounting</p>		<b>UF 60 91 34 75</b>	R/L		308	321	340	407	448	481	524	576	-		
		 <i>Important! Hinge right means drill hole for handle on left-hand side of right door.</i>													
 <p><b>Crockery cupboard</b> 2 doors 64.6 cm 1 fixed shelf 4 adjustable shelves</p>		<b>GG 45 13 55</b>	R/L ■		328	341	392	477	528	557	618	680	-		
		<b>GG 50 13 55</b>	R/L ■		328	341	392	526	569	601	660	726	-		
		<b>GG 60 13 55</b>	R/L ■		367	381	440	621	677	710	782	860	-		


## Crockery cupboards with glass fronts

Carcass height 91 cm, 130 cm carcass depth 34 cm,  
Carcass height 130 cm, carcass depth 55.5 cm (standard)



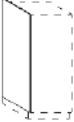

		Order no.			Hinge side:	Carcass depth	Glass groups				
		W	H	D			G1	G2	G2S	G5S	G6
 <p><b>Base unit with glass front</b> -neutral- 1 glass door 90.6 cm 2 adjustable glass shelves with wall mounting</p>		<b>UGD 45 91 34</b>	R/L		-	519	519	603	903		
		<b>UGD 50 91 34</b>	R/L		-	540	540	631	924		
		<b>UGD 60 91 34</b>	R/L		-	594	594	700	978		
 <p><b>Crockery cupboard with glass front</b> 2 glass doors 64.6 cm 1 fixed shelf 4 adjustable shelves</p>		<b>GGGD 45 13 55</b>	R/L ■		-	-	909	1063	1293		
		<b>GGGD 50 13 55</b>	R/L ■		-	-	928	1091	1312		
		<b>GGGD 60 13 55</b>	R/L ■		-	-	1012	1205	1396		

G 1		G 2		G 2S	
<b>G1 AKTIVglass frame</b> 991 Matt glass 992 Translucent black glass		<b>G2 Design front</b> 925 Frame White Agate/Matt glass 935 Premium W. Frame/Matt Glass 940 Macaron Col. Frame/Matt Glass 95 Light grey frame/matt glass 96 Silver Col. Frame/Matt Glass 960 Snow White Frame/Matt Glass 97 Black frame/black glass		<b>G2S aluminium, framed glass door</b> 988 aluminium black, Linea glass 994 Aluminium frame/clear glass 995 aluminium frame/black glass	
G 5		G 5S		G 6	
		<b>G5S aluminium, door with mullion</b> 996 Alum.frame/clear gl./cross bar		<b>G6 NEW SALON</b> 986 aluminium black, black glass 987 aluminium black, clear glass 989 aluminium matt, bronze-coloured black glass 990 aluminium matt, bronze-coloured clear glass	



# Tall units Back cladding

		Order no. W H D		Hinge side:	Carcass depth	Decor groups									
						M10	M20	M30	M40	M50	M60	M70	M80	M90	
 <p><b>Back cladding</b> For tall units, 130 cm high 16 mm thick</p>	per 10 cm Width														
	<b>GVK 13</b> minimum price					26	45	52	69	69	69	69	69	69	-
						-	-	-	-	-	-	-	-	-	-
M 10	M 20	M 30	M 40	M 50											
K M10 laminate	D M20 Laminate decor	I M30 RESOPAL PRO super matt IH M30 HPL PRO PW M30 PRIMEWOOD/Basic Veneer	A M40 DIRECTLACK matt L M40 DIRECTLACK high-gloss	B M50 Velvet lacquer S M50 microstructure lacquer											
M 60	M 70	M 80	M 90												
QH M60 SMARTGLAS high-gloss QM M60 SMARTGLAS satin-finish	F M70 veneer / oak / walnut Z M70 Veneer / Bavaria	C1 M80 FENIX stainless-steel look H M80 high gloss-Lacquer MP M80 laqué mat Premium													


## Tall units Visible sides / increased side depth

 <p><b>Tall unit visible side</b>  55.5 cm side depth Fixed dimension, not variable</p>			<p> <b>Important!</b> Installation instead of a normal unit side. Only available in the listed side depths. For other dimensions, use GSVT...</p>													
	<b>GSV 13</b>		R/L	0	0	109	109	145	145	181	230	-				
 <p><b>Tall unit increased side depth</b>  from 61.1 cm up to 90 cm side depth Up to 60.9 cm side depth</p>			<p> <b>Important!</b> Installation instead of a normal unit side.</p>													
	<b>GSVT 13</b>		R/L	87	116	236	236	316	316	396	500	-				
	<b>GSVT 13 6</b>		R/L	42	55	159	159	211	211	264	335	-				
M 10	M 20	M 30	M 40	M 50												
K M10 laminate	D M20 Laminate decor	I M30 RESOPAL PRO super matt IH M30 HPL PRO PW M30 PRIMEWOOD/Basic Veneer	A M40 DIRECTLACK matt L M40 DIRECTLACK high-gloss	B M50 Velvet lacquer P M50 Soft lacquer RH M50 Velvet lacquer wood texture RW M50 Velvet lacquer spackle effect S M50 microstructure lacquer												
M 60	M 70	M 80	M 90													
QH M60 SMARTGLAS high-gloss QM M60 SMARTGLAS satin-finish	F M70 veneer / oak / walnut V M70 Velvet lacquer textured Z M70 Veneer / Bavaria	C1 M80 FENIX stainless-steel look H M80 high gloss-Lacquer MP M80 laqué mat Premium O M80 Veneered														

## Panel brackets



	Order no. W H D	Unit price	Hinge side:	Carcase depth	Decor groups																				
					M10	M20	M30	M40	M50	M60	M70	M80	M90												
 <b>Panel brackets</b> Shelf of 5 cm panel material suitable for Carcase depth 34 cm		Unit price																							
		<b>PK 50 90 36</b>			109	-	-	-	177	-	237	409	-												
		Unit price																							
		<b>PK 50 100 36</b>			120	-	-	-	195	-	265	451	-												
		Unit price																							
		<b>PK 50 120 36</b>			144	-	-	-	235	-	319	545	-												
		 <b>Important!</b> For fitting to the left or right of a base unit																							
<b>Panel brackets</b> Shelf of 5 cm panel material suitable for Carcase depth 45.5 cm		Unit price																							
		<b>PK 50 90 48</b>			144	-	-	-	235	-	319	545	-												
		Unit price																							
		<b>PK 50 100 48</b>			161	-	-	-	261	-	356	605	-												
		Unit price																							
		<b>PK 50 120 48</b>			193	-	-	-	314	-	424	727	-												
<b>Panel brackets</b> Shelf of 5 cm panel material suitable for Carcase depth 55.5 cm / Carcase depth 61 cm		Unit price																							
		<b>PK 50 90 58</b>			173	-	-	-	285	-	384	657	-												
		Unit price																							
		<b>PK 50 90 63</b>			173	-	-	-	285	-	384	657	-												
		Unit price																							
		<b>PK 50 100 63</b>			194	-	-	-	316	-	429	731	-												
		Unit price																							
		<b>PK 50 100 58</b>			194	-	-	-	316	-	429	731	-												
		Unit price																							
		<b>PK 50 120 58</b>			233	-	-	-	377	-	515	876	-												
		Unit price																							
		<b>PK 50 120 63</b>			233	-	-	-	377	-	515	876	-												
<b>Panel brackets</b> Shelf of 5 cm panel material suitable for Carcase depth 70.5 cm		Unit price																							
		<b>PK 50 90 73</b>			218	-	-	-	357	-	485	828	-												
		Unit price																							
		<b>PK 50 100 73</b>			244	-	-	-	399	-	540	921	-												
		Unit price																							
		<b>PK 50 120 73</b>			295	-	-	-	480	-	647	1105	-												
<b>Panel brackets</b> Shelf of 5 cm panel material		pro m <sup>2</sup> , B x D																							
		<b>PK 50 00</b>			332	-	-	-	546	-	738	1259	-												

## Panel back walls



 <b>Panel back wall</b> Back panel 1.6 cm with wall mounting		per 10 cm Height																		
		<b>PR 90</b>			7,50	-	-	-	39	-	54	64	-							
		<b>minimum price</b>			-	-	-	-	-	-	-	-	-							
		per 10 cm Height																		
		<b>PR 100</b>			8,40	-	-	-	45	-	63	70	-							
		<b>minimum price</b>			-	-	-	-	-	-	-	-	-							
		per 10 cm Height																		
		<b>PR 120</b>			10,10	-	-	-	52	-	73	84	-							
		<b>minimum price</b>			-	-	-	-	-	-	-	-	-							
<b>Panel back wall</b> Back panel 1.6 cm with wall mounting		per m <sup>2</sup> , W x H																		
		<b>PR 00</b>			84	-	-	-	432	-	612	695	-							
		<b>minimum price</b>			46	-	-	-	73	-	119	131	-							

M 10	M 50	M 70	M 80
K50 M10 Laminate K005S Castell Oak K023P Stainless Steel Colour K039G Premium white glossy K039P Premium white K043P Graphite Black K058P Magic-grey K075P Black K076P Macaron K160F Snow White K160G Snow White Gloss K178F White Agate K190S Mammoth oak natural K199S Piemont Oak K216S natural mountain oak K218P Light Pepper K229S Classic Oak K230P Art Pepper K235P Titan Steel K236S Diamond Oak effect K247S Dark Maron effect K248P Light Nude K262S Royal Oak effect K263P Fango K269S Mountain Wood K270S Elegant walnut effect	B50 M50 Velvet lacquer S50 M50 micro structured lacquer	F50 M70 veneer / walnut / oak Z50 M70 Veneer / Bavaria	H50 M80 High gloss-Lacquer MP50 M80 Matt-Lacquer Premium


## Push-fit shelves 50 mm

		Order no. W H D		Hinge side:	Carcass depth	Decor groups								
						M10	M20	M30	M40	M50	M60	M70	M80	M90
	<b>Push-fit shelf</b> 18 mm deep, 50 cm thick With concealed mounting fitting Max. length 230 cm, min. length 23 cm	per 10 cm Width												
		<b>WSB 50 18</b> minimum price				20,60	-	-	-	26	-	35	38	-
						63	-	-	-	99	-	158	173	-
	<b>Push-fit shelf</b> 36.5 mm deep, 50 cm thick With concealed mounting fitting Max. length 230 cm, min. length 23 cm	per 10 cm Width												
		<b>WSB 50 36</b> minimum price				33	-	-	-	40	-	48	66	-
						103	-	-	-	140	-	195	228	-
M 10	M 50	M 70	M 80											
K50 M10 Laminate 50 mm K005S Castell Oak K023P Stainless Steel Colour K039G Premium white glossy K039P Premium white K043P Graphite Black K058P Magic-grey K075P Black K076P Macaron K160F Snow White K160G Snow White Gloss K178F White Agate K190S Mammoth oak natural K199S Piemont Oak K216S natural mountain oak K218P Light Pepper K229S Classic Oak K230P Art Pepper K235P Titan Steel K236S Diamond Oak effect K247S Dark Maron effect K248P Light Nude K262S Royal Oak effect K263P Fango K269S Mountain Wood K270S Elegant walnut effect	B50 M50 Velvet lacquer 50 mm S50 M50 micro structured lacquer	F50 M70 veneer / walnut / oak 50 mm Z50 M70 Veneer / Bavaria 50 mm	H50 M80 High gloss-Lacquer 50 mm MP50 M80 Matt-Lacquer Premium											


## Push-fit shelves 25 mm

	<b>Push-fit shelf</b> 18 mm deep, 25 cm thick With concealed mounting fitting Max. length 260 cm, min. length 23 cm Available in all panel colours	per 10 cm Width												
		<b>WSB 25 18</b> minimum price				9,60	14	-	-	19,20	-	22,80	29,60	-
						52	75	-	-	86	-	139	156	-
	<b>Push-fit shelf</b> 25 mm deep, 25 cm thick With concealed mounting fitting Max. length 260 cm, min. length 23 cm Available in all panel colours	per 10 cm Width												
		<b>WSB 25 25</b> minimum price				13,60	19,60	-	-	26,70	-	32	41	-
						52	75	-	-	86	-	139	156	-
M 10	M 20	M 30	M 40	M 50										
K25 M10 Laminate 25 mm	D25 M20 Accessory decor 25 mm D149W Brown concrete effect D187W Concrete effect opal D188W Concrete effect pearl grey D212W graphite concrete effect			B25 M50 Velvet lacquer 25 mm S25 M50 micro structured lacquer F25 M70 veneer / oak 25 mm										
M 60	M 70	M 80	M 90											
	Z25 M70 veneer / Bavaria 25 mm	H25 M80 High gloss-Lacquer 25 mm MP25 M80 Matt-Lacquer Premium O25 M80 Veneered 25 mm												







## Panel shelves 16 mm

		Order no. W H D	Hinge side: Carcase depth	Decor groups																
				M10	M20	M30	M40	M50	M60	M70	M80	M90								
<b>Panel shelf 16 mm</b> edge on all sides 100XX100mm		pro m <sup>2</sup> , B x D																		
		<b>WBS 16</b>																		
		<b>minimum price</b>																		
		 <b>Important!</b> This material is not suitable for table tops! Maximum dimensions see section 2																		
<b>M 10</b>	<b>M 20</b>	<b>M 30</b>	<b>M 40</b>	<b>M 50</b>																
K M10 laminate	D M20 Laminate decor	I M30 RESOPAL PRO super matt IH M30 HPL PRO PW M30 PRIMEWOOD/Basic Veneer	A M40 DIRECTLACK matt L M40 DIRECTLACK high-gloss	B M50 Velvet lacquer P M50 Soft lacquer RH M50 Velvet lacquer wood texture RW M50 Velvet lacquer spackle effect S M50 microstructure lacquer																
<b>M 60</b>	<b>M 70</b>	<b>M 80</b>	<b>M 90</b>																	
QH M60 SMARTGLAS high-gloss QM M60 SMARTGLAS satin-finish	F M70 veneer / oak / walnut V M70 Velvet lacquer textured Z M70 Veneer / Bavaria	C1 M80 FENIX stainless-steel look H M80 high gloss-Lacquer MP M80 laqué mat Premium O M80 Veneered	A116 M90 Worktop decor																	

## Panel shelves 25 mm

<b>Panel shelf 25 mm</b> edge on all sides 100XX100mm		pro m <sup>2</sup> , B x D																		
		<b>WBS 25</b>																		
		<b>minimum price</b>																		
		 <b>Important!</b> This material is not suitable for table tops! Maximum dimensions see section 2																		
<b>M 10</b>	<b>M 20</b>	<b>M 30</b>	<b>M 40</b>	<b>M 50</b>																
K25 M10 Laminate 25 mm	D25 M20 Accessory decor 25 mm D149W Brown concrete effect D187W Concrete effect opal D188W Concrete effect pearl grey D212W graphite concrete effect			B25 M50 Velvet lacquer 25 mm S25 M50 micro structured lacquer																
<b>M 60</b>	<b>M 70</b>	<b>M 80</b>	<b>M 90</b>																	
	F25 M70 veneer / oak 25 mm Z25 M70 veneer / Bavaria 25 mm	H25 M80 High gloss-Lacquer 25 mm MP25 M80 Matt-Lacquer Premium O25 M80 Veneered 25 mm																		

## Plinth bases

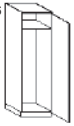



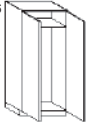











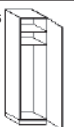



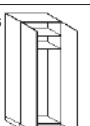



 <p>suitable for carcase depth 34 cm (plinth base 33.5 cm deep)</p> <p>suitable for carcase depth 45.5 cm (plinth base 45 cm deep)</p> <p>suitable for carcase depth 55.5 cm (plinth base 55 cm deep)</p> <p>suitable for carcase depth 55.5 cm (plinth base 55 cm deep)</p> <p>suitable for carcase depth 70.5 cm (plinth base 70 cm deep)</p>	per 10 cm Width																			
	<b>SB 25 34</b>																			
	4,80																			
	per 10 cm Width																			
	<b>SB 25 45</b>																			
	6,30																			
per 10 cm Width																				
<b>SB 25 55</b>																				
7,50																				
per 10 cm Width																				
<b>SB 25 61</b>																				
7,50																				
per 10 cm Width																				
<b>SB 25 70</b>																				
9,60																				
		 <b>Note:</b> The plinth base is supplied set back by 5 mm in relation to the carcase with free-standing sides (front and side).  <b>Decor groups for plinth base</b> K Laminate K023P stainless steel-coloured																		
 <p><b>Sliding nails for plinth base</b>                      For installation under the plinth base                      Material: metal, diameter 21 mm, height 2.5 mm                      Packaging units (10 and 20 items)</p>	<b>GNSB 10</b>																			
	<b>GNSB 20</b>																			
	27,80 54																			
		 <b>Planning advice:</b> We recommend the sliding nails for hard floors (e.g. tiles, laminate, parquet etc.)																		
 <p><b>Adjustment feet for plinth base</b>                      Incl. fixing material                      3 cm high, adjustment range 15 mm,                      stainless steel-coloured, price per item</p>	<b>SFSB</b>																			
	4,60																			
		 <b>Planning advice:</b> Please plan adjustment feet front and rear every 80 cm.																		





# Hall cupboards and coat stands

Carcase depth 61.0 cm

	Order no.	W	H	D	Hinge side:	Carcase depth	Price groups										
							1	2	3	4	5	6	7	8	9		
 <p><b>1946 Hall cupboard / coat stand</b> 1 door 194.6 cm 1 fixed shelf 1 garment rail at a height of 156 cm plus plinth height</p> <p>Carcase depth 61 cm Usable inside depth 58.5 cm</p>	 61,0		GK	45	19	61	70	R/L	688	712	735	862	952	1004	1078	1184	-
			GK	50	19	61	70	R/L	699	724	746	873	964	1015	1089	1196	-
			GK	60	19	61	70	R/L	711	735	758	884	976	1027	1101	1209	-
	<p><b>Not available for:</b> ALUELEMENTS, ATLANTA-B, ATLANTA-S, BERGEN, CASTELLO, CHALET-B, CHALET-S, CHICAGO, FRAME, LUGANO, LUX-B, MIAMI, MODENA, MUNICH, NEVADA, NOBEL-B, NOBEL-S, ORLANDO-B, ORLANDO-S, OSLO 15, PADUA, SOFIE-B, SOFIE-S, TESSIN 15, TIM 15, VINO, VIVA, YORK-B, YORK-S</p> <p> Each front has a tightening fitting Ranges without fitting: SMARTGLAS, NOBEL, SOFIE, YORK, LUGANO, TALEA, RIVA, GARDA, ATLANTA, ORLANDO, CHICAGO without tightening fitting</p>																
 <p><b>1946 Hall cupboard / coat stand</b> 2 doors 194.6 cm 1 fixed shelf 1 garment rail at a height of 156 cm plus plinth height</p> <p>Carcase depth 61 cm Usable inside depth 58.5 cm</p>	 61,0		GK	90	19	61	70		1359	1408	1454	1707	1887	1991	2139	2350	-
			GK	100	19	61	70		1382	1430	1477	1729	1911	2015	2161	2374	-
			<p><b>Not available for:</b> ALUELEMENTS, ATLANTA-B, ATLANTA-S, BERGEN, CASTELLO, CHALET-B, CHALET-S, CHICAGO, FRAME, LUGANO, LUX-B, MIAMI, MODENA, MUNICH, NEVADA, NOBEL-B, NOBEL-S, ORLANDO-B, ORLANDO-S, OSLO 15, PADUA, SOFIE-B, SOFIE-S, TESSIN 15, TIM 15, VINO, VIVA, YORK-B, YORK-S</p> <p> Each front has a tightening fitting Ranges without fitting: SMARTGLAS, NOBEL, SOFIE, YORK, LUGANO, TALEA, RIVA, GARDA, ATLANTA, ORLANDO, CHICAGO without tightening fitting</p>														
	 <p><b>2076 Hall cupboard / coat stand</b> 1 door 207.6 cm 1 fixed shelf 1 garment rail at a height of 156 cm plus plinth height</p> <p>Carcase depth 61 cm Usable inside depth 58.5 cm</p>	 61,0		GK	45	20	61	70	R/L	711	738	759	885	977	1027	1103	1211
GK				50	20	61	70	R/L	723	748	770	897	989	1039	1114	1223	-
GK				60	20	61	70	R/L	734	760	783	909	999	1050	1127	1238	-
<p><b>Not available for:</b> ALUELEMENTS, ATLANTA-B, ATLANTA-S, BERGEN, CASTELLO, CHALET-B, CHALET-S, CHICAGO, FRAME, GARDA, LUGANO, LUX-B, MIAMI, MODENA, MUNICH, NEVADA, NOBEL-B, NOBEL-S, ORLANDO-B, ORLANDO-S, OSLO 15, PADUA, SOFIE-B, SOFIE-S, TESSIN 15, TIM 15, TREND, VINO, VIVA, YORK-B, YORK-S</p> <p> Each front has a tightening fitting Ranges without fitting: SMARTGLAS, NOBEL, SOFIE, YORK, LUGANO, TALEA, RIVA, GARDA, ATLANTA, ORLANDO, CHICAGO without tightening fitting</p>																	
 <p><b>2076 Hall cupboard / coat stand</b> 2 doors 207.6 cm 1 fixed shelf 1 garment rail at a height of 156 cm plus plinth height</p> <p>Carcase depth 61 cm Usable inside depth 58.5 cm</p>	 61,0		GK	90	20	61	70		1406	1458	1501	1755	1937	2037	2189	2405	-
			GK	100	20	61	70		1428	1481	1525	1778	1958	2061	2212	2431	-
			<p><b>Not available for:</b> ALUELEMENTS, ATLANTA-B, ATLANTA-S, BERGEN, CASTELLO, CHALET-B, CHALET-S, CHICAGO, FRAME, GARDA, LUGANO, LUX-B, MIAMI, MODENA, MUNICH, NEVADA, NOBEL-B, NOBEL-S, ORLANDO-B, ORLANDO-S, OSLO 15, PADUA, SOFIE-B, SOFIE-S, TESSIN 15, TIM 15, TREND, VINO, VIVA, YORK-B, YORK-S</p> <p> Each front has a tightening fitting Ranges without fitting: SMARTGLAS, NOBEL, SOFIE, YORK, LUGANO, TALEA, RIVA, GARDA, ATLANTA, ORLANDO, CHICAGO without tightening fitting</p>														
	 <p><b>2206 Hall cupboard / coat stand</b> 1 door 220.6 cm 1 fixed shelf 1 garment rail at a height of 156 cm plus plinth height 1 adjustable shelf</p> <p>Carcase depth 61 cm Usable inside depth 58.5 cm</p>	 61,0		GK	45	22	61	70	R/L	784	809	830	956	1049	1101	1174	1289
GK				50	22	61	70	R/L	795	819	842	969	1061	1112	1185	1301	-
GK				60	22	61	70	R/L	806	831	854	980	1071	1124	1198	1316	-
<p><b>Not available for:</b> ALUELEMENTS, ATLANTA-B, ATLANTA-S, BERGEN, CASTELLO, CHALET-B, CHALET-S, CHICAGO, FRAME, GARDA, LUGANO, LUX-B, MIAMI, MODENA, MUNICH, NEVADA, NOBEL-B, NOBEL-S, ORLANDO-B, ORLANDO-S, OSLO 15, PADUA, SOFIE-B, SOFIE-S, TESSIN 15, TIM 15, TREND, VINO, VIVA, YORK-B, YORK-S</p> <p> Each front has a tightening fitting Ranges without fitting: SMARTGLAS, NOBEL, SOFIE, YORK, LUGANO, TALEA, RIVA, GARDA, ATLANTA, ORLANDO, CHICAGO without tightening fitting</p>																	
 <p><b>2206 Hall cupboard / coat stand</b> 2 doors 220.6 cm 1 fixed shelf 1 garment rail at a height of 156 cm plus plinth height 1 adjustable shelf</p> <p>Carcase depth 61 cm Usable inside depth 58.5 cm</p>	 61,0		GK	90	22	61	70		1550	1600	1645	1898	2081	2185	2333	2564	-
			GK	100	22	61	70		1574	1623	1667	1920	2104	2207	2355	2588	-
			<p><b>Not available for:</b> ALUELEMENTS, ATLANTA-B, ATLANTA-S, BERGEN, CASTELLO, CHALET-B, CHALET-S, CHICAGO, FRAME, GARDA, LUGANO, LUX-B, MIAMI, MODENA, MUNICH, NEVADA, NOBEL-B, NOBEL-S, ORLANDO-B, ORLANDO-S, OSLO 15, PADUA, SOFIE-B, SOFIE-S, TESSIN 15, TIM 15, TREND, VINO, VIVA, YORK-B, YORK-S</p> <p> Each front has a tightening fitting Ranges without fitting: SMARTGLAS, NOBEL, SOFIE, YORK, LUGANO, TALEA, RIVA, GARDA, ATLANTA, ORLANDO, CHICAGO without tightening fitting</p>														



KOMFORT  
KÜCHEN

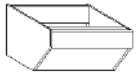



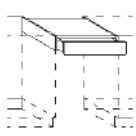


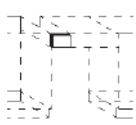
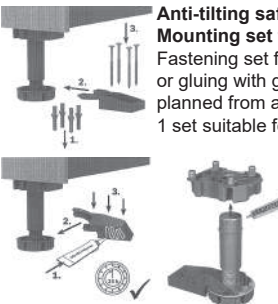

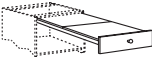





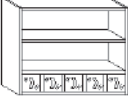
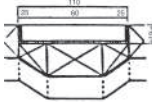
# KOMFORT KÜCHEN



# Comfort-kitchen

		Order no.	W	H	D	Hinge side:	Carcase depth	Price groups								
								1	2	3	4	5	6	7	8	9
 <p><b>Sink carcase angled</b> 1 panel 12.6 cm with angled cut to the rear in carcase material (only decor group K) 34 cm deep at bottom</p>						▲		339	343	359	383	403	414	423	465	-
						▲		339	343	359	383	403	414	423	465	-
						▲		339	343	359	383	403	414	437	481	-
						▲		343	352	368	406	423	437	461	507	-
						▲		379	391	414	509	552	570	602	662	-
						▲		379	391	414	509	552	570	602	662	-
						▲		390	399	421	519	571	585	623	685	-
						▲		438	447	485	579	613	631	674	741	-
		 Only plan in combination with 16 mm top cover and 34 cm deep unit below.														
 <p><b>Liftboy single tray</b> For subsequent installation in wall units 60 or 90 cm wide and 78 or 91 cm high. Only for folding-lifting or swing-door units.</p>																
 <p><b>Liftboy single tray</b> For subsequent installation in wall units 90 cm wide and 78 cm high. Only for folding-lifting or swing-door units</p>																
<p><b>Liftboy double tray</b> for subsequent installation in wall units 60 cm wide and 91 cm high. Only for swing-door units.</p>																
 <p><b>Drawer element</b> With top shelf 1 drawer 12.6 cm for installation under worktops height 13 cm</p>						■	178	181	194	237	237	250	268	295	-	
						■	178	181	194	237	237	250	268	295	-	
						■	178	181	194	237	237	250	268	295	-	
						■	178	181	194	237	237	250	268	295	-	
						■	250	257	277	340	340	357	386	425	-	
						■	250	257	277	340	340	357	386	425	-	
						■	278	288	310	371	371	385	418	460	-	
						■	294	299	322	389	389	403	436	480	-	
		 Width 30, 40, 45, 50, 60, 80, 90, 100, 120  Width 70 Not available for: ALUELEMENTS, MIAMI, STRIP ELEMENTS, VIVA														
 <p><b>Drawer element</b> <b>Front filler</b> 5 - 20 cm</p>								40	40	40	71	71	71	77	85	-
 <p><b>Anti-tilting safety device</b> <b>Mounting set for base units</b> Fastening set for base cabinets for screwing or gluing with glue for floor mounting, can be planned from a plinth height of 10 cm 1 set suitable for 1 base unit</p>								39								
		 <b>Note:</b> Mounting hardware is not included in the scope of delivery and must therefore be obtained by the customer. Base units - whether standing against the wall or used in island form - must also be secured in place to prevent them from toppling over. Attention: Gluing on laminate, PVC and linoleum floors is not permitted! <b>For free-standing base units, KS-U is added automatically.</b>														
 <p><b>Pull-out table (extendable by 81.5 cm)</b> for installation in 50 or 60 cm wide units Pull-out table, stainless steel-coloured (instead of a drawer, without panel) max. load 30 kg</p>								316								
		 <b>Important!</b> Installation above a structural shelf is not possible Only available in combination with carcase depth 55.5 cm														

# Comfort-kitchen Shelf units

		Order no. W H D	Hinge side:	Carcase depth	Decor groups									
					M10	M20	M30	M40	M50	M60	M70	M80	M90	
 <p><b>Aperture shelf unit with containers</b> Shelf unit for aperture 480 mm high 17 cm deep, back panel 16 mm 1 fixed shelf</p> <p>Width 40 cm: 3 glass containers Width 50 cm: 4 glass containers Width 60 cm: 5 glass containers</p>		<b>KNR 40 48 17</b>			667	-	-	-	-	-	-	-	-	-
		<b>KNR 50 48 17</b>			766	-	-	-	-	-	-	-	-	-
		<b>KNR 60 48 17</b>			864	-	-	-	-	-	-	-	-	-
<p><b>Mounting wall</b> for fixing set-forward cooker hoods, wall units and shelf units depth 15 cm</p> <p>52 cm high 65 cm high 78 cm high 91 cm high</p>		<b>MOW 60 52</b>			108									
		<b>MOW 60 65</b>			108									
		<b>MOW 60 78</b>			108									
		<b>MOW 60 91</b>			108									
<p><b>Mounting wall</b> for fixing set-forward cooker hoods, wall units and shelf units depth 15 cm</p> <p>52 cm high 65 cm high 78 cm high 91 cm high</p>		<b>MOW 90 52</b>			108									
		<b>MOW 90 65</b>			108									
		<b>MOW 90 78</b>			108									
		<b>MOW 90 91</b>			108									
 <p><b>Mounting wall</b> For fixing set-forward cooker hoods and wall units or shelf units Width: 110 x 19 cm deep</p> <p>52 cm high 65 cm high 78 cm high 91 cm high 113 cm high 126 cm high 139 cm high</p>		<b>MOW 110 52</b>			108									
		<b>MOW 110 65</b>			108									
		<b>MOW 110 78</b>			108									
		<b>MOW 110 91</b>			108									
		<b>MOW 110 113</b>			128									
		<b>MOW 110 126</b>			128									
		<b>MOW 110 139</b>			128									
<p><b>Mounting wall</b> for fixing set-forward cooker hoods, wall units and shelf units Variable up to 110 cm width depth 15 cm</p> <p>52 cm high 65 cm high 78 cm high 91 cm high</p>		<b>MOW 00 52</b>			136									
		<b>MOW 00 65</b>			136									
		<b>MOW 00 78</b>			136									
		<b>MOW 00 91</b>			136									
<b>M 10</b>	<b>M 20</b>	<b>M 30</b>	<b>M 40</b>	<b>M 50</b>										
Shelves K M10 laminate														
<b>M 60</b>	<b>M 70</b>	<b>M 80</b>	<b>M 90</b>											

# 7.2

## System Home Economics elements

Base units Home Economics	XL 7.2.1
Tall units Home Economics Laundry sorter - tall unit	XL 7.2.1-XL 7.2.2
Larder unit for bottle crates	XL 7.2.2-XL 7.2.3
Tall units Home Economics Shoe cupboard	XL 7.2.3-XL 7.2.6
Tall units Home Economics Tool and recycling tall unit	XL 7.2.6
Washing machine/dryer scenarios Home Economics	XL 7.2.7
Accessories Home Economics	XL 7.2.7-XL 7.2.8

### Legend:



Available with grip ledge N...



Not available with grip ledge N...



This symbol indicates which models are available



This symbol indicates which models are not available



Planning advice



Merchandise net



Not available with „push-to-open“ fitting

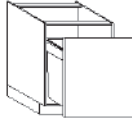

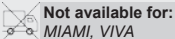
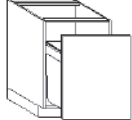

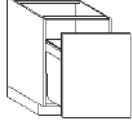

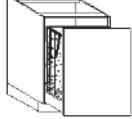

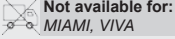
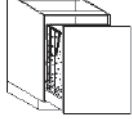



wall-mounted units

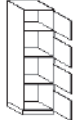

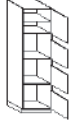

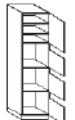













# Base units Home Economics

						Price groups								
		Order no.		Hinge side:	Carcase depth	1	2	3	4	5	6	7	8	9
		W	H	D										
711	 <p><b>Base unit with laundry baskets</b> 1 pull-out with front panel 71.1 cm with frame and 2 laundry baskets (white) for dropping in (Hailo) 2-compartment sorting, 33 litres each</p> <p>Carcase height 71.5 cm</p>		UW 60 72 55 07	▲	639	652	674	738	774	794	837	921	-	
														
776	 <p><b>Base unit with laundry baskets</b> 1 pull-out with front panel 77.6 cm with frame and 2 laundry baskets (white) for dropping in (Hailo) 2-compartment sorting, 33 litres each</p> <p>Carcase height 78 cm</p>		UW 60 78 55 07	▲	644	657	677	743	781	803	844	928	-	
841	 <p><b>Base unit with laundry baskets</b> 1 pull-out with front panel 84.1 cm with frame and 2 laundry baskets (white) for dropping in (Hailo) 2-compartment sorting, 33 litres each</p> <p>Carcase height 84.5 cm</p>		UW 60 85 55 07	▲	663	677	697	765	804	827	869	956	-	
			UW 60 85 61 07		663	677	697	765	804	827	869	956	-	
711	 <p><b>Recyclable material and recycling base unit</b> 1 pull-out 71.1 cm 2 frame element for hanging recyclable material bags or recycling containers complete with cover 2 recycling container made of reinforced plastic materials</p> <p>Carcase height 71.5 cm</p>		UWR 60 72 55 01	▲	719	731	755	815	848	872	913	1004	-	
														
776	 <p><b>Recyclable material and recycling base unit</b> 1 pull-out 77.6 cm 2 frame element for hanging recyclable material bags or recycling containers complete with cover 2 recycling container made of reinforced plastic materials</p> <p>Carcase height 78 cm</p>		UWR 60 78 55 01	▲	722	736	760	824	861	879	924	1016	-	

## Tall units Home Economics Laundry sorter - tall unit

386 386 386 386	 <p><b>Laundry sorter - tall unit</b> 1 door 38.6 cm With „push to open“ fitting 3 compartments 52 cm with 3 doors 38.6 cm without handle 3 openings each of 13 cm 3 fixed shelves</p> <p>Carcase height: 194.8 cm</p>		GGW 60 19 55	R/L ▲	591	607	663	901	957	990	1063	1169	-	
516 386 386 386	 <p><b>Laundry sorter - tall unit</b> 1 door 51.6 cm With „push to open“ fitting 1 adjustable shelf 3 compartments 52 cm with 3 doors 38.6 cm without handle 3 openings each of 13 cm 3 fixed shelves</p> <p>Carcase height: 207.8 cm</p>		GGW 60 20 55	R/L ▲	611	623	687	935	992	1030	1105	1216	-	
646 386 386 386	 <p><b>Laundry sorter - tall unit</b> 1 door 64.6 cm With „push to open“ fitting 2 adjustable shelves 3 compartments 52 cm with 3 doors 38.6 cm without handle 3 openings each of 13 cm 3 fixed shelves</p> <p>Carcase height: 220.8 cm</p>		GGW 60 22 55	R/L ▲	626	650	709	972	1031	1068	1149	1264	-	
	<p><b>Hailo Laundry basket</b> Hailo Laundry Area 60 cm laundry basket Hailo laundry basket as stand-alone module Material: plastic Colour: white Dimensions: 520 x 462 x 304 mm Volume: 41 l</p>		HLA-EWK		74									
			 The laundry basket is sufficient for one washing machine load.											
	<p><b>Utensils container-Set</b> consisting of: 2 x utensils container, white 1 wall-mounting for utensils container, dark gray</p>		HLA-UB		54									

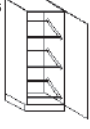




# Tall units Home Economics Laundry sorter - tall unit

	Order no. W H D	Hinge side: R/L ▲	Carcase depth	Price groups								
				1	2	3	4	5	6	7	8	9
 <p><b>Laundry tall unit</b>                      1 door 116.6 cm with wide angle hinges                      1 utensils container set, loose                      (2 x utensils containers, colour white)                      1 Utensils box, loose                      1 adjustable shelf                      1 internal drawer                      1 fixed shelf                      1 pull-out with front panel 77.6 cm                      with frame and 2 laundry baskets                      (white) for dropping in (Hailo)                      2-compartment sorting, 33 litres each</p> <p>Carcase height: 194.8 cm</p>	<b>GWA 60 19 55 01</b>	R/L ▲		1129	1148	1202	1439	1497	1530	1601	1761	-
 <p><b>Laundry tall unit</b>                      1 door 129.6 cm with wide angle hinges                      1 utensils container set, loose                      (2 x utensils containers, colour white)                      1 Utensils box, loose                      2 adjustable shelves                      1 internal drawer                      1 fixed shelf                      1 pull-out with front panel 77.6 cm                      with frame and 2 laundry baskets                      (white) for dropping in (Hailo)                      2-compartment sorting, 33 litres each</p> <p>Carcase height: 207.8 cm</p>	<b>GWA 60 20 55 01</b>	R/L ▲	⚡	Not available with TIP-ON								
 <p><b>Laundry tall unit</b>                      1 door 142.6 cm with wide angle hinges                      1 utensils container set, loose                      (2 x utensils containers, colour white)                      1 Utensils box, loose                      2 adjustable shelves                      1 internal drawer                      1 fixed shelf                      1 pull-out with front panel 77.6 cm                      with frame and 2 laundry baskets                      (white) for dropping in (Hailo)                      2-compartment sorting, 33 litres each</p> <p>Carcase height: 220.8 cm</p>	<b>GWA 60 22 55 01</b>	R/L ▲	⚡	Not available with TIP-ON								

## Larder unit for bottle crates



Carcase height 143 - 220.8 cm

▲ = Types also available with 61 cm carcase depth (order no. ... replace ... 55 ... with 61)




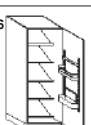
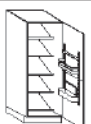
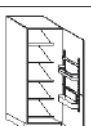
 <p><b>Larder unit for bottle crates</b>                      1 door 142.6 cm                      3 metal holder frames for bottle crates</p> <p>Carcase height: 143 cm</p>	<b>GGK 60 14 55 70</b>	R/L ▲		586	601	660	841	898	930	1002	1102	-
 <p><b>Larder unit for bottle crates</b>                      1 door 155.6 cm                      3 metal holder frames for bottle crates</p> <p>Carcase height: 156 cm</p>	<b>GGK 60 15 55 70</b>	R/L ▲	⚡	Width 60 Not available for: CASTELLO, FRAME, MUNICH, NEVADA, VINO, VIVA								
 <p><b>Larder unit for bottle crates</b>                      1 door 168.6 cm                      1 fixed shelf                      3 metal holder frames for bottle crates</p> <p>Carcase height: 168.8 cm</p>	<b>GGK 60 16 55 70</b>	R/L ▲	⚡	Each front has a tightening fitting Ranges without fitting: SMARTGLAS, NOBEL, SOFIE, YORK, LUGANO, TALEA, RIVA, GARDA, ATLANTA, ORLANDO, CHICAGO without tightening fitting								
 <p><b>Larder unit for bottle crates</b>                      1 door 181.6 cm                      1 fixed shelf                      3 metal holder frames for bottle crates</p> <p>Carcase height: 181.8 cm</p>	<b>GGK 60 18 55 70</b>	R/L ▲	⚡	Width 60 Not available for: ALUELEMENTS, ATLANTA-B, ATLANTA-S, BERGEN, CASTELLO, CHALET-B, CHALET-S, CHICAGO, FRAME, LUGANO, LUX-B, MIAMI, MODENA, MUNICH, NEVADA, NOBEL-B, NOBEL-S, ORLANDO-B, ORLANDO-S, OSLO 15, PADUA, SOFIE-B, SOFIE-S, TESSIN 15, TIM 15, VINO, VIVA, YORK-B, YORK-S								
 <p><b>Larder unit for bottle crates</b>                      1 door 194.6 cm                      1 adjustable shelf                      1 fixed shelf                      3 metal holder frames for bottle crates</p> <p>Carcase height: 194.8 cm</p>	<b>GGK 60 19 55 70</b>	R/L ▲	⚡	Each front has a tightening fitting Ranges without fitting: SMARTGLAS, NOBEL, SOFIE, YORK, LUGANO, TALEA, RIVA, GARDA, ATLANTA, ORLANDO, CHICAGO without tightening fitting								



**Larder unit  
for bottle crates**  
Carcase height 143 - 220.8 cm













		Price groups										
		1	2	3	4	5	6	7	8	9		
Order no.	W H D											
▲ = Types also available with 61 cm carcase depth (order no. ... replace ... 55 ... with 61)												
2076	 <p><b>Larder unit for bottle crates</b> 1 door 207.6 cm 2 adjustable shelves 1 fixed shelf 3 metal holder frames for bottle crates</p> <p>Carcase height: 207.8 cm</p>	GGK 60 20 55 70	R/L ▲	678	691	755	1003	1060	1097	1172	1289	-
		<p><b>Width 60 Not available for:</b> ALUELEMENTS, ATLANTA-B, ATLANTA-S, BERGEN, CASTELLO, CHALET-B, CHALET-S, CHICAGO, FRAME, GARDA, LUGANO, LUX-B, MIAMI, MODENA, MUNICH, NEVADA, NOBEL-B, NOBEL-S, ORLANDO-B, ORLANDO-S, OSLO 15, PADUA, SOFIE-B, SOFIE-S, TESSIN 15, TIM 15, TREND, VINO, VIVA, YORK-B, YORK-S</p> <p>Each front has a tightening fitting</p> <p>Ranges without fitting: SMARTGLAS, NOBEL, SOFIE, YORK, LUGANO, TALEA, RIVA, GARDA, ATLANTA, ORLANDO, CHICAGO without tightening fitting</p>										
2206	 <p><b>Larder unit for bottle crates</b> 1 door 220.6 cm 2 adjustable shelves 1 fixed shelf 3 metal holder frames for bottle crates</p> <p>Carcase height: 220.8 cm</p>	GGK 60 22 55 70	R/L ▲	694	718	777	1040	1098	1136	1217	1339	-
		<p><b>Width 60 Not available for:</b> ALUELEMENTS, ATLANTA-B, ATLANTA-S, BERGEN, CASTELLO, CHALET-B, CHALET-S, CHICAGO, FRAME, GARDA, LUGANO, LUX-B, MIAMI, MODENA, MUNICH, NEVADA, NOBEL-B, NOBEL-S, ORLANDO-B, ORLANDO-S, OSLO 15, PADUA, SOFIE-B, SOFIE-S, TESSIN 15, TIM 15, TREND, VINO, VIVA, YORK-B, YORK-S</p> <p>Each front has a tightening fitting</p> <p>Ranges without fitting: SMARTGLAS, NOBEL, SOFIE, YORK, LUGANO, TALEA, RIVA, GARDA, ATLANTA, ORLANDO, CHICAGO without tightening fitting</p>										

**Tall units Home Economics Shoe cupboard**  
Carcase height 143 - 220.8 cm

1426	 <p><b>Shoe cupboard</b> 1 door 142.6 cm 5 metal shoe racks prepared for angled mounting with integrated ventilation Storage system, consisting of: 1 set of attachment rails, anthracite 1 large 3-side tray with rail, anthracite 1 carrying box for cleaning products, with profile handles, anthracite 1 hook rail with 5 hooks, anthracite</p> <p>Carcase height: 143 cm</p>	GGSH 60 14 55 70	R/L ▲	870	884	943	1125	1181	1213	1286	1415	-
646 776	 <p><b>Shoe cupboard</b> 1 door 64.6 cm connected to 1 door 77.6 cm 5 metal shoe racks prepared for angled mounting with integrated ventilation Storage system, consisting of: 1 set of attachment rails, anthracite 1 large 3-side tray with rail, anthracite 1 carrying box for cleaning products, with profile handles, anthracite 1 hook rail with 5 hooks, anthracite</p> <p>Carcase height: 143 cm</p>	GGSH 60 14 55 11	R/L ▲	870	884	943	1125	1181	1213	1286	1415	-
776 646	 <p><b>Shoe cupboard</b> 1 door 77.6 cm connected to 1 door 64.6 cm 5 metal shoe racks prepared for angled mounting with integrated ventilation Storage system, consisting of: 1 set of attachment rails, anthracite 1 large 3-side tray with rail, anthracite 1 carrying box for cleaning products, with profile handles, anthracite 1 hook rail with 5 hooks, anthracite</p> <p>Carcase height: 156 cm</p>	GGSH 60 14 55 12	R/L ▲	870	884	943	1125	1181	1213	1286	1415	-
1556	 <p><b>Shoe cupboard</b> 1 door 155.6 cm 5 metal shoe racks prepared for angled mounting with integrated ventilation Storage system, consisting of: 1 set of attachment rails, anthracite 1 large 3-side tray with rail, anthracite 1 carrying box for cleaning products, with profile handles, anthracite 1 hook rail with 5 hooks, anthracite</p> <p>Carcase height: 156 cm</p>	GGSH 60 15 55 70	R/L ▲	950	968	1061	1205	1262	1294	1365	1502	-
		<p><b>Width 60 Not available for:</b> CASTELLO, FRAME, MUNICH, NEVADA, VINO, VIVA</p> <p>Each front has a tightening fitting</p> <p>Ranges without fitting: SMARTGLAS, NOBEL, SOFIE, YORK, LUGANO, TALEA, RIVA, GARDA, ATLANTA, ORLANDO, CHICAGO without tightening fitting</p>										
776 776	 <p><b>Shoe cupboard</b> 1 door 77.6 cm connected to 1 door 77.6 cm 5 metal shoe racks prepared for angled mounting with integrated ventilation Storage system, consisting of: 1 set of attachment rails, anthracite 1 large 3-side tray with rail, anthracite 1 carrying box for cleaning products, with profile handles, anthracite 1 hook rail with 5 hooks, anthracite</p> <p>Carcase height: 156 cm</p>	GGSH 60 15 55 11	R/L ▲	870	884	943	1125	1181	1213	1286	1415	-
906 646	 <p><b>Shoe cupboard</b> 1 door 90.6 cm connected to 1 door 64.6 cm 5 metal shoe racks prepared for angled mounting with integrated ventilation Storage system, consisting of: 1 set of attachment rails, anthracite 1 large 3-side tray with rail, anthracite 1 carrying box for cleaning products, with profile handles, anthracite 1 hook rail with 5 hooks, anthracite</p> <p>Carcase height: 156 cm</p>	GGSH 60 15 55 12	R/L ▲	870	884	943	1125	1181	1213	1286	1415	-

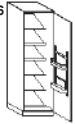












# Tall units Home Economics Shoe cupboard

Carcase height 143 - 220.8 cm

		Price groups									
		1	2	3	4	5	6	7	8	9	
 <p>1686 Carcase height: 168.8 cm</p>	<p><b>Shoe cupboard</b> 1 door 168.6 cm 6 metal shoe racks prepared for angled mounting with integrated ventilation Storage system, consisting of: 1 set of attachment rails, anthracite 1 large 3-side tray with rail, anthracite 1 carrying box for cleaning products, with profile handles, anthracite 1 hook rail with 5 hooks, anthracite</p>	<p>Order no. W H D</p>	Hinge side:	Carcase depth:							
	<p><b>GGSH 60 16 55 70</b></p> <p> <b>Width 60 Not available for:</b> ALUELEMENTS, ATLANTA-B, ATLANTA-S, BERGEN, CASTELLO, CHALET-B, CHALET-S, CHICAGO, FRAME, LUGANO, LUX-B, MIAMI, MODENA, MUNICH, NEVADA, NOBEL-B, NOBEL-S, ORLANDO-B, ORLANDO-S, OSLO 15, PADUA, SOFIE-B, SOFIE-S, TESSIN 15, TIM 15, VINO, VIVA, YORK-B, YORK-S</p> <p> Each front has a tightening fitting Ranges without fitting: SMARTGLAS, NOBEL, SOFIE, YORK, LUGANO, TALEA, RIVA, GARDA, ATLANTA, ORLANDO, CHICAGO without tightening fitting</p>	R/L ▲	▲	994	1012	1106	1250	1306	1339	1410	1551
 <p>906 776 Carcase height: 168.8 cm</p>	<p><b>Shoe cupboard</b> 1 door 90.6 cm connected to 1 door 77.6 cm 6 metal shoe racks prepared for angled mounting with integrated ventilation Storage system, consisting of: 1 set of attachment rails, anthracite 1 large 3-side tray with rail, anthracite 1 carrying box for cleaning products, with profile handles, anthracite 1 hook rail with 5 hooks, anthracite</p>										
	<p><b>GGSH 60 16 55 11</b></p>	R/L ▲	▲	915	929	988	1168	1225	1257	1329	1462
 <p>1036 776 Carcase height: 181.8 cm</p>	<p><b>Shoe cupboard</b> 1 door 103.6 cm connected to 1 door 77.6 cm 6 metal shoe racks prepared for angled mounting with integrated ventilation Storage system, consisting of: 1 set of attachment rails, anthracite 1 large 3-side tray with rail, anthracite 1 carrying box for cleaning products, with profile handles, anthracite 1 hook rail with 5 hooks, anthracite</p>										
	<p><b>GGSH 60 18 55 11</b></p>	R/L ▲	▲	915	929	988	1168	1225	1257	1329	1462
 <p>1166 646 Carcase height: 181.8 cm</p>	<p><b>Shoe cupboard</b> 1 door 116.6 cm connected to 1 door 64.6 cm 6 metal shoe racks prepared for angled mounting with integrated ventilation Storage system, consisting of: 1 set of attachment rails, anthracite 1 large 3-side tray with rail, anthracite 1 carrying box for cleaning products, with profile handles, anthracite 1 hook rail with 5 hooks, anthracite</p>										
	<p><b>GGSH 60 18 55 12</b></p>	R/L ▲	▲	915	929	988	1168	1225	1257	1329	1462
 <p>1816 Carcase height: 181.8 cm</p>	<p><b>Shoe cupboard</b> 1 door 181.6 cm 6 metal shoe racks prepared for angled mounting with integrated ventilation Storage system, consisting of: 1 set of attachment rails, anthracite 1 large 3-side tray with rail, anthracite 1 carrying box for cleaning products, with profile handles, anthracite 1 hook rail with 5 hooks, anthracite</p>	<p></p>									
	<p><b>GGSH 60 18 55 70</b></p> <p> <b>Width 60 Not available for:</b> ALUELEMENTS, ATLANTA-B, ATLANTA-S, BERGEN, CASTELLO, CHALET-B, CHALET-S, CHICAGO, FRAME, LUGANO, LUX-B, MIAMI, MODENA, MUNICH, NEVADA, NOBEL-B, NOBEL-S, ORLANDO-B, ORLANDO-S, OSLO 15, PADUA, SOFIE-B, SOFIE-S, TESSIN 15, TIM 15, VINO, VIVA, YORK-B, YORK-S</p> <p> Each front has a tightening fitting Ranges without fitting: SMARTGLAS, NOBEL, SOFIE, YORK, LUGANO, TALEA, RIVA, GARDA, ATLANTA, ORLANDO, CHICAGO without tightening fitting</p>	R/L ▲	▲	994	1012	1106	1250	1306	1339	1410	1551
 <p>1166 776 Carcase height: 194.8 cm</p>	<p><b>Shoe cupboard</b> 1 door 116.6 cm connected to 1 door 77.6 cm 6 metal shoe racks prepared for angled mounting with integrated ventilation Storage system, consisting of: 1 set of attachment rails, anthracite 1 large 3-side tray with rail, anthracite 1 carrying box for cleaning products, with profile handles, anthracite 1 hook rail with 5 hooks, anthracite</p>										
	<p><b>GGSH 60 19 55 11</b></p>	R/L ▲	▲	938	956	1011	1249	1305	1339	1410	1551
 <p>1296 646 Carcase height: 194.8 cm</p>	<p><b>Shoe cupboard</b> 1 door 129.6 cm connected to 1 door 64.6 cm 6 metal shoe racks prepared for angled mounting with integrated ventilation Storage system, consisting of: 1 set of attachment rails, anthracite 1 large 3-side tray with rail, anthracite 1 carrying box for cleaning products, with profile handles, anthracite 1 hook rail with 5 hooks, anthracite</p>										
	<p><b>GGSH 60 19 55 12</b></p>	R/L ▲	▲	938	956	1011	1249	1305	1339	1410	1551

# Tall units Home Economics Shoe cupboard

Carcase height 143 - 220.8 cm

				Price groups										
		Order no.		Hinge side:	Carcase depth:	1	2	3	4	5	6	7	8	9
		W H D												
1816	 <p>Carcase height: 194.8 cm</p>		<p><b>Shoe cupboard</b> 1 door 194.6 cm 6 metal shoe racks prepared for angled mounting with integrated ventilation Storage system, consisting of: 1 set of attachment rails, anthracite 1 large 3-side tray with rail, anthracite 1 carrying box for cleaning products, with profile handles, anthracite 1 hook rail with 5 hooks, anthracite</p>	<b>GGSH 60 19 55 70</b>	R/L ▲	1020	1037	1091	1329	1386	1418	1491	1640	-
				<p><b>Width 60 Not available for:</b> ALUELEMENTS, ATLANTA-B, ATLANTA-S, BERGEN, CASTELLO, CHALET-B, CHALET-S, CHICAGO, FRAME, LUGANO, LUX-B, MIAMI, MODENA, MUNICH, NEVADA, NOBEL-B, NOBEL-S, ORLANDO-B, ORLANDO-S, OSLO 15, PADUA, SOFIE-B, SOFIE-S, TESSIN 15, TIM 15, VINO, VIVA, YORK-B, YORK-S</p> <p> Each front has a tightening fitting Ranges without fitting: SMARTGLAS, NOBEL, SOFIE, YORK, LUGANO, TALEA, RIVA, GARDA, ATLANTA, ORLANDO, CHICAGO without tightening fitting</p>										
1296 776	 <p>Carcase height: 207.8 cm</p>		<p><b>Shoe cupboard</b> 1 door 129.6 cm connected to 1 door 77.6 cm 7 metal shoe racks prepared for angled mounting with integrated ventilation Storage system, consisting of: 1 set of attachment rails, anthracite 1 large 3-side tray with rail, anthracite 1 carrying box for cleaning products, with profile handles, anthracite 1 hook rail with 5 hooks, anthracite</p>	<b>GGSH 60 20 55 11</b>	R/L ▲	1004	1017	1079	1327	1385	1421	1498	1648	-
1426 646	 <p>Carcase height: 207.8 cm</p>		<p><b>Shoe cupboard</b> 1 door 142.6 cm connected to 1 door 64.6 cm 7 metal shoe racks prepared for angled mounting with integrated ventilation Storage system, consisting of: 1 set of attachment rails, anthracite 1 large 3-side tray with rail, anthracite 1 carrying box for cleaning products, with profile handles, anthracite 1 hook rail with 5 hooks, anthracite</p>	<b>GGSH 60 20 55 12</b>	R/L ▲	1004	1017	1079	1327	1385	1421	1498	1648	-
2076	 <p>Carcase height: 207.8 cm</p>		<p><b>Shoe cupboard</b> 1 door 207.6 cm 7 metal shoe racks prepared for angled mounting with integrated ventilation Storage system, consisting of: 1 set of attachment rails, anthracite 1 large 3-side tray with rail, anthracite 1 carrying box for cleaning products, with profile handles, anthracite 1 hook rail with 5 hooks, anthracite</p>	<b>GGSH 60 20 55 70</b>	R/L ▲	1084	1096	1160	1409	1465	1503	1577	1735	-
				<p><b>Width 60 Not available for:</b> ALUELEMENTS, ATLANTA-B, ATLANTA-S, BERGEN, CASTELLO, CHALET-B, CHALET-S, CHICAGO, FRAME, GARDA, LUGANO, LUX-B, MIAMI, MODENA, MUNICH, NEVADA, NOBEL-B, NOBEL-S, ORLANDO-B, ORLANDO-S, OSLO 15, PADUA, SOFIE-B, SOFIE-S, TESSIN 15, TIM 15, TREND, VINO, VIVA, YORK-B, YORK-S</p> <p> Each front has a tightening fitting Ranges without fitting: SMARTGLAS, NOBEL, SOFIE, YORK, LUGANO, TALEA, RIVA, GARDA, ATLANTA, ORLANDO, CHICAGO without tightening fitting</p>										
906 646 646	 <p>Carcase height: 220.8 cm</p>		<p><b>Shoe cupboard</b> 1 door 90.6 cm with 1 door 64.6 cm connected to 1 door 64.6 cm 7 metal shoe racks prepared for angled mounting with integrated ventilation Storage system, consisting of: 1 set of attachment rails, anthracite 1 large 3-side tray with rail, anthracite 1 carrying box for cleaning products, with profile handles, anthracite 1 hook rail with 5 hooks, anthracite</p>	<b>GGSH 60 22 55 12</b>	R/L ▲	1043	1065	1125	1384	1448	1484	1564	1720	-
1426 776	 <p>Carcase height: 220.8 cm</p>		<p><b>Shoe cupboard</b> 1 door 142.6 cm attached to 1 door 77.6 cm 7 metal shoe racks prepared for angled mounting with integrated ventilation Ventilation grille included uninstalled Storage system, consisting of: 1 set of attachment rails, anthracite 1 large 3-side tray with rail, anthracite 1 carrying box for cleaning products, with profile handles, anthracite 1 hook rail with 5 hooks, anthracite</p>	<b>GGSH 60 22 55 11</b>	R/L ▲	1020	1040	1100	1364	1423	1460	1541	1695	-
2206	 <p>Carcase height: 220.8 cm</p>		<p><b>Shoe cupboard</b> 1 door 220.6 cm 7 metal shoe racks prepared for angled mounting with integrated ventilation Storage system, consisting of: 1 set of attachment rails, anthracite 1 large 3-side tray with rail, anthracite 1 carrying box for cleaning products, with profile handles, anthracite 1 hook rail with 5 hooks, anthracite</p>	<b>GGSH 60 22 55 70</b>	R/L ▲	1100	1124	1182	1445	1504	1542	1622	1784	-
				<p><b>Width 60 Not available for:</b> ALUELEMENTS, ATLANTA-B, ATLANTA-S, BERGEN, CASTELLO, CHALET-B, CHALET-S, CHICAGO, FRAME, GARDA, LUGANO, LUX-B, MIAMI, MODENA, MUNICH, NEVADA, NOBEL-B, NOBEL-S, ORLANDO-B, ORLANDO-S, OSLO 15, PADUA, SOFIE-B, SOFIE-S, TESSIN 15, TIM 15, TREND, VINO, VIVA, YORK-B, YORK-S</p> <p> Each front has a tightening fitting Ranges without fitting: SMARTGLAS, NOBEL, SOFIE, YORK, LUGANO, TALEA, RIVA, GARDA, ATLANTA, ORLANDO, CHICAGO without tightening fitting</p>										

## Tall units Home Economics Shoe cupboard

Carcase height 143 - 220.8 cm

		Price groups															
		1	2	3	4	5	6	7	8	9							
Order no. W H D																	
<b>Shoe cupboard</b> 1 door 77.6 cm connected to 1 door 142.6 cm 7 metal shoe racks prepared for angled mounting with integrated ventilation Storage system, consisting of: 1 set of attachment rails, anthracite 1 large 3-side tray with rail, anthracite 1 carrying box for cleaning products, with profile handles, anthracite 1 hook rail with 5 hooks, anthracite		<b>GGS</b>	<b>60</b>	<b>22</b>	<b>55</b>	<b>021</b>	R/L	▲	1020	1040	1100	1364	1423	1460	1541	1695	-

776  
1426



Carcase height:  
220.8 cm

1036  
126  
776



Carcase height:  
194.8 cm

1166  
126  
776



Carcase height:  
207.8 cm

1296  
126  
776



Carcase height:  
220.8 cm

		Price groups														
		1	2	3	4	5	6	7	8	9						
<b>Tall units Home Economics Tool and recycling tall unit</b> Carcase height 143 - 220.8 cm																
<b>Recyclable material and recycling tall unit</b> 1 door 103.6 cm 3 adjustable shelves 1 drawer 12.6 cm with cutlery organiser BE-LB 60 1 pull-out 77.6 cm 2 frame element for hanging recyclable material bags or recycling containers complete with cover 2 recycling container made of reinforced plastic materials		<b>GWR</b>	<b>60</b>	<b>19</b>	<b>55</b>	R/L	▲	1265	1309	1414	1459	1536	1589	1672	1839	-
<b>Recyclable material and recycling tall unit</b> 1 door 116.6 cm 3 adjustable shelves 1 drawer 12.6 cm with cutlery organiser BE-LB 60 1 pull-out 77.6 cm 2 frame element for hanging recyclable material bags or recycling containers complete with cover 2 recycling container made of reinforced plastic materials		<b>GWR</b>	<b>60</b>	<b>20</b>	<b>55</b>	R/L	▲	1274	1333	1439	1488	1570	1623	1709	1880	-
<b>Recyclable material and recycling tall unit</b> 1 door 129.6 cm 3 adjustable shelves 1 drawer 12.6 cm with cutlery organiser BE-LB 60 1 pull-out 77.6 cm 2 frame element for hanging recyclable material bags or recycling containers complete with cover 2 recycling container made of reinforced plastic materials		<b>GWR</b>	<b>60</b>	<b>22</b>	<b>55</b>	R/L	▲	1293	1358	1472	1522	1605	1658	1744	1918	-



# Washing machine/dryer scenarios Home Economics

Carcase height 143 - 220.8 cm



Top-mount unit with door  
A 60 52 55 70  
Appliance  
UWT 60 52 55 11

Planning height 194.8 cm



Top-mount unit with door  
A 60 65 55 70  
Appliance  
UWT 60 52 55 11

Planning height 207.8 cm

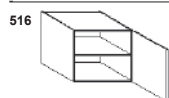


Top-mount unit with door  
A 60 78 55 78  
Appliance  
UWT 60 52 55 11

Planning height 220.8 cm

		Price groups								
Hinge side:	Carcase depth	1	2	3	4	5	6	7	8	9

Order no.  
W H D

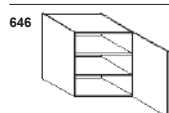


**Dresser unit**  
1 door 51.6 cm  
1 adjustable shelf

Carcase height 52 cm

516	A	30 52 55 70	R/L	<input type="checkbox"/>	269	278	301	352	369	383	413	454	-
		40 52 55 70	R/L	<input type="checkbox"/>	269	278	301	356	369	390	417	459	-
		45 52 55 70	R/L	<input type="checkbox"/>	269	278	301	356	369	390	417	459	-
		50 52 55 70	R/L	<input type="checkbox"/>	269	278	301	356	390	412	446	491	-
		60 52 55 70	R/L	<input type="checkbox"/>	301	312	328	392	437	462	500	550	-
		70 52 55 70	R/L	<input type="checkbox"/>	376	390	410	490	546	578	625	688	-
		75 52 55 70	R/L	<input type="checkbox"/>	376	390	410	490	546	578	625	688	-

Width 30, 40, 45, 50, 60  
Width 70 Not available for: ALUELEMENTS, MIAMI, STRIP ELEMENTS, VIVA  
Width 75 Not available for: ALUELEMENTS, FRAME, MIAMI, STRIP ELEMENTS, VIVA

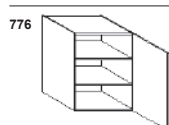


**Dresser unit**  
1 door 64.6 cm  
2 adjustable shelves

Carcase height 65 cm

646	A	30 65 55 70	R/L	<input type="checkbox"/>	279	287	311	361	377	393	422	464	-
		40 65 55 70	R/L	<input type="checkbox"/>	279	287	311	366	377	400	425	468	-
		45 65 55 70	R/L	<input type="checkbox"/>	279	287	311	366	377	400	425	468	-
		50 65 55 70	R/L	<input type="checkbox"/>	279	287	311	366	400	421	458	504	-
		60 65 55 70	R/L	<input type="checkbox"/>	312	323	340	403	446	473	512	563	-
		70 65 55 70	R/L	<input type="checkbox"/>	390	404	425	504	558	591	640	704	-
		75 65 55 70	R/L	<input type="checkbox"/>	390	404	425	504	558	591	640	704	-

Width 30, 40, 45, 50, 60  
Width 70 Not available for: ALUELEMENTS, MIAMI, STRIP ELEMENTS, VIVA  
Width 75 Not available for: ALUELEMENTS, FRAME, MIAMI, STRIP ELEMENTS, VIVA

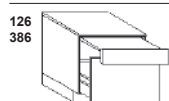


**Dresser unit**  
1 door 77.6 cm  
2 adjustable shelves

Carcase height 78 cm

776	A	30 78 55 70	R/L	<input type="checkbox"/>	294	303	324	374	419	443	484	532	-
		40 78 55 70	R/L	<input type="checkbox"/>	294	303	324	374	419	443	484	532	-
		45 78 55 70	R/L	<input type="checkbox"/>	294	303	324	374	419	443	484	532	-
		50 78 55 70	R/L	<input type="checkbox"/>	294	303	324	374	419	443	484	532	-
		60 78 55 70	R/L	<input type="checkbox"/>	317	328	348	412	455	482	522	574	-
		70 78 55 70	R/L	<input type="checkbox"/>	396	410	435	515	569	603	653	718	-
		75 78 55 70	R/L	<input type="checkbox"/>	396	410	435	515	569	603	653	718	-

Width 30, 40, 45, 50, 60  
Width 70 Not available for: ALUELEMENTS, MIAMI, STRIP ELEMENTS, VIVA  
Width 75 Not available for: ALUELEMENTS, FRAME, MIAMI, STRIP ELEMENTS, VIVA



**Housing for raised washing machine/dryer**  
1 panel 12.6 cm with pull-out table (extendable by 81.5 cm)  
Maximum load-bearing capacity of pull-out table 30 kg  
Pull-out table, stainless steel-coloured  
1 pull-out 38.6 cm  
1 panel shelf 19 mm  
1 aluminium protective shelf

Item height 53.9 cm

126 386	UWT	60 52 55 11		<input checked="" type="checkbox"/>	864	875	921	986	986	1018	1068	1175	-
		<p> Only electrical appliances with electric balance control are to be used. The appliances must be secured on site such that they cannot accidentally move forward from the carcass during operation. The planning must always provide for a side enclosure on both sides (through a wall or by adjacent cabinets or panels). The installation instructions of the appliance manufacturers must be observed.</p>											

## Accessories Home Economics



**Metal frame for holding bottle crates**  
suitable for unit types in 60 cm width  
Finish: metal, anthracite  
incl. mounting and fixing material

MHG 60			41										
--------	--	--	----	--	--	--	--	--	--	--	--	--	--



**Metal shoe racks with raised back edge**  
suitable for unit types in 60 cm width  
Finish: metal, anthracite  
incl. mounting and fixing material









MBS 60			30										
--------	--	--	----	--	--	--	--	--	--	--	--	--	--



**Hailo Laundry basket**  
Hailo Laundry Area 60 cm laundry basket  
Hailo laundry basket as stand-alone module  
Material: plastic  
Colour: white  
Dimensions: 520 x 462 x 304 mm  
Volume: 41 l

HLA-EWK			74										
<p> The laundry basket is sufficient for one washing machine load.</p>													

# Accessories Home Economics

				Price groups			
		Order no. W H D	Hinge side: Carcase depth	1			
	<b>Utensils container-Set</b> consisting of: 2 x utensils container, white 1 wall-mounting for utensils container, dark gray	<b>HLA-UB</b>		54			
	<b>Mounting rail</b> 1 set of attachment rails, anthracite	<b>HW-BL100</b>		39			
	<b>Storage surface with rail</b> 1 large 3-side tray with rail, anthracite	<b>HW-ABLR</b>		44			
	<b>Carrying box</b> 1 carrying box for cleaning products, with profile handles, anthracite	<b>HW-TB</b>		61			
	<b>Hook rail with 5 hooks</b> 1 hook profile with 5 utensil hooks, anthracite	<b>HW-HLE5</b>		25			
	<b>Hook rail with 5 hooks</b> 1 hook profile with 5 utensil hooks, laterally screw-mounted, anthracite	<b>HW-HLS5</b>		23			
	<b>Holder</b> Holder for vacuum cleaner hose or PET storage pocket (for screwing on), anthracite	<b>HW-HS</b>		23			
	<b>Utensils box</b> Utensils box, e.g. for storing towels, cleaning cloths, etc. (for screwing on), anthracite	<b>HW-UB</b>		54			

# 7.3

## MULTIROOM

### MULTI ROOM

MULTIROOM	XL 7.3.1
HOMETOOL	XL 7.3.3
Design suggestions	XL 7.3.4
ROOMBASE	XL 7.3.5
ROOMBASE Base units	XL 7.3.5
Design suggestions	XL 7.3.6
PIROUETTE	XL 7.3.7

#### Legend:



Planning advice



Merchandise net



This symbol indicates which models are available



This symbol indicates which models are not available



The times of apartments for students and undemanding singles as cheap living areas in a small space are clearly over: It is not just in our big cities that rents are rising to such an extent that the size of living spaces will consequently decrease in the long term.

At the same time, new functions are moving into our apartments that were previously not to be found there. Even for young, high-earning couples, things will become tight in an 80 m<sup>2</sup> apartment when both of them suddenly have to work from home a lot. With corresponding contemporary floor plan solutions, there is often no separate kitchen: Cooking and eating are integrated into the living space.

The multifunctional PIRQUETTE kitchen is a response to these trends: With the smallest possible footprint, the integrated island/counter solution defines a separate area for cooking. At the same time, the concept combines the functions of living and working visually and functionally with the actual kitchen. In addition to the compact combination of kitchen-typical functional areas, this is made possible primarily by the swivelling table module: In the twinkling of an eye, it can be transformed from an ergonomic standing work surface to a dining table for up to 4 people or an intimate workspace solution for the home office by simply swivelling it.

PIRQUETTE is a solution for modern couples without taking into account the usual distribution of roles: Cooking is part of everyday life for both of them; a communicative act. While the man prepares the meal, the woman creates a presentation for the next meeting on the computer: However, she does not have to sit at the kitchen table while the man is working around her: If the swivel table is swivelled into the home office position, the functional areas are separated from each other without the use-areas colliding with each other. At the same time, they are only a few meters away from each other; the couple can communicate. For example, he can hand her a snack over the counter while she is talking to her colleagues in a Zoom conference (if you swivel the table into the home office position, there is a neutral wall behind the user, creating a perfect, plain background for a video conference ...)

In combination with the supplementary (but also stand-alone as an option) functional elements HOMETOOL and ROOM BASE, completely new room configurations can be implemented for the planner: Both modules enable different areas of use and room zones to be interlinked without separating them: They offer additional storage space or work space wherever it is needed. These elements provide screening and therefore help to subdivide small rooms into urgently needed zones - but at the same time enable a generous feeling of good living through interesting visual and functional relationships: When two or more people live in a small area and few rooms are available, flexible private areas are especially important for harmonious coexistence.

The home office is here to stay: in the future people will be spending time together more often in a smaller apartment. Complemented by flexible individual modules such as HOMETOOL and ROOM BASE, PIRQUETTE offers a multifunctional, space-saving solution to cleverly master the new challenges of modern living.

design by Michael Hilgers

The trained furniture designer and architect Michael Hilgers considers himself to be a design pioneer. In his works developed for renowned manufacturers, he always combines ingenuity with a minimalist design. Hilgers' innovative but at the same time amazingly simple furniture solutions exemplify his philosophy of questioning traditional product categories for today's living and working environment and rethinking them with pragmatism.

The (multi)functional, flexible and space-saving pioneering products developed in his Berlin studio have repeatedly won him awards, for example the Interior Innovation Award.



HOMETOOL



ROOM BASE



PIRQUETTE



Planning advice: W H D

Overall dimensions: 944 2098 577

The element may not be used as a stand-alone unit - it must be affixed to the wall

The element is only available in the specified combination and technical design

A shelf above or below the bar flap is not technically possible - it would not be possible to open the bar flap!

The element is only available with Push-to-open for all elements (offset handles and grip ledges not possible)

26 available carcass colours

The shelf unit can also be selected from the decor groups

S = micro textured lacquer

B = matt lacquer

F = veneer

Z = veneer / Bavaria

.

Order no.  
W H D

Hinge side: Carcase depth	Price groups								
	1	2	3	4	5	6	7	8	9
R/L	3892	4430	5030	5705	6004	6191	7257	7980	-
R/L	4462	5001	5600	6276	6575	6761	7828	8608	-
R/L	4462	5001	5600	6276	6575	6761	7828	8608	-
R/L	4462	5001	5600	6276	6575	6761	7828	8608	-
R/L	4462	5001	5600	6276	6575	6761	7828	8608	-



**HOMETOOL multi-functional element**  
consisting of:

1 plinth support  
for 555 mm depth (WxHxD 900 x 150 x 555 mm)

1 add-on plinth element with 1 drawer  
with Tip-On (WxHxD 900 x 217 x 555 mm)

2 front material for lateral facing,  
from plinth element

2 top-mounted elements with bar flap door  
including in-base Push-to-open  
(WxHxD 900 x 390 x 155 mm)

1 top-mounted shelf unit (WxHxD 900 x 606 x  
177 mm)

1 top-mounted wardrobe element, 1 garment rail,  
loose  
including Push-to-open (WxHxD 400 x 1386 x  
605 mm)

1 top-mounted crockery unit with 4 adjustable  
shelves,  
including Push-to-open (WxHxD 400 x 1386 x  
265 mm)

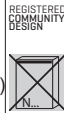
2 front material, for lateral facing,  
1 top-mounted element with flap, flap on right,  
protruding, including Push-to-open in base panel  
(WxHxD 555 x 345 x 555 mm)

1 top-mounted element with flap, flap on right,  
protruding, including Push-to-open in base panel  
(WxHxD 555 x 345 x 345 mm)

2 wider front flap doors (front) for  
top-mounted element protruding on the right  
(WxHxD 575 x 341 x 19 mm)

1 front material for front  
panel on flap door unit

2 x front material, for rear facing  
Spacing material for front panelling



**Width 94 Available for:** ARTE-B, ARTE-S, BAVARIA, CASA-B, EDITION, FENIX INOX, FLORENZ, GARDA, HPL PRO, MALMÖ, MODENA, MONTANA, MPX, MUNICH, NEVADA, PADUA, PALAZZO, PRIMEWOOD TOP, PUR, RESOPAL, RESOPAL PRO, RESOPAL PRO EDGE, RIVA, RUSTY OAK, SHERWOOD, SIGNUM-B, SMART, SMART MIRROR, SMART-M, TIM, TOP, TREND

M 10	M 20	M 30	M 40	M 50
K M10 laminate				B M50 Velvet Lacquer S M50 Microstructure Lacquer
M 60	M 70	M 80	M 90	
	F M70 veneer / oak / walnut Z M70 Veneer / Bavaria			





## Planning advice:

Overall dimensions in mm: W1633 H2310 D(430)

- The element may not be used as a free-standing unit
- At least one side must be attached to the wall
- The external and internal dimensions are set and cannot be changed
- Units can be planned freely within the range of dimensions.

Dimensions planning area base units in mm: W1500 H780 D555

Dimensions planning area wall units in mm: W1532 H650 D339

- The 50 mm panels can only be selected from decor group K.
- The bar frame is designed for a carcass height of 78 cm with a 10cm plinth.
- Worktop thickness 16-38 mm (other worktop thicknesses are also available if the bar is not used)



## Design suggestion 1

Consisting of

- 1 RB 163 236 43 ROOMBASE room-divider element
- 1 RB-TG 15 35 6 FREESTYLE bar support frame, including cross members and foot bar
- 1 worktop, 16 or 25 mm (1532 x 617 mm)
- 3 RB U 50 78 55 70 base unit Height 78 cm Width 50 cm 1 door, 2 adjustable shelves
- 1 AP 16 D60 bar/worktop, 16 mm (1532 x 600mm)
- 1 Z 33Z plinth panel for base units
- 2 WS 16 panel, 16 mm (780x615 mm)
- 1 UVF 78 rear panelling for base units with screw-fitted fronts (1500 x 780mm)
- 1 H 50 65 34 70 wall unit, 65 mm tall, 50 cm wide
- 2 H 60 65 34 70 wall unit, 51,6 cm wide
- 2 SA 50 BH width reduction to 516 mm
- 1 HVF 65 rear panelling for wall units with screw-fitted fronts

## Design suggestion 2

Consisting of

- 1 RB 163 236 43 ROOMBASE room-divider element
- 1 RB-TG 15 35 6 FREESTYLE bar support frame, including cross members and foot bar
- 1 worktop, 16 or 25 mm (1532 x 617 mm)
- 3 RB U 50 78 55 70 base unit, height 78 cm, width 50 cm 1 door, 2 adjustable shelves
- 1 AP 16 D60 bar/worktop, 16 mm (1532 x 600mm)
- 1 Z 33Z plinth panel for base units for rear
- 2 WS 16 panel, 16 mm (780x615 mm)
- 1 UVF 78 rear panelling for base units with screw-fitted fronts
- 2 HR 60 65 36 wall shelf unit, height 65 cm, custom width 51.6 cm
- 1 HR 50 65 36 wall shelf unit, height 65 cm, width 50 cm
- 1 HVF 65 rear panelling for wall units with screw-fitted fronts

## Design suggestion 3

Consisting of

- 1 RB 163 236 43 ROOMBASE room-divider element
- 1 RB-TG 15 35 6 FREESTYLE bar support frame, including cross members and foot bar
- 1 worktop, 16 or 25 mm (1532 x 617 mm)
- 3 RB U 50 78 55 12 base unit, height 78 cm, width 50 cm 1 drawer, 2 pull-outs
- 1 AP 16 D60 bar/worktop, 16 mm (1532 x 600mm)
- 1 Z 33Z plinth panel for base units for rear
- 2 WS 16 panel, 16 mm (780x615 mm)
- 1 UVF 78 rear panelling for base units with screw-fitted fronts
- Plan with 3 wall units
- 1 H 50 65 34 70 wall unit, 65 mm tall, 50 cm wide
- 2 H 60 65 34 70 wall unit, 65 mm tall, 51.6 cm wide
- 2 SA 50 BH width reduction to 516 mm
- 1 HVF 65 rear panelling for wall units with screw-fitted fronts




**ROOMBASE**

**ROOM  
BASE**

Order no.  
W H D

Hinge side:	Carcase depth	Decor groups								
		M10								
		1279								
		846								



**ROOMBASE room-divider element**  
consisting of:

2 custom panels, 50 mm, reinforced and drilled (WxHxD 50 x 2310 x 430 mm)

1 custom panel, 50 mm, reinforced and drilled (WxHxD 50 x 1633 x 430 mm)


1 panel as support, 25 mm (WxHxD 1532 x 25 x 398 mm)

**RB 163 236 43**

**Add-on bar (option)**  
FREESTYLE bar support (WxHxD 1532 x 1100 x 560 mm) with 2 lengthways stays

including cross members and foot bar



**RB-TG15356**

 1 worktop, 16 or 25 mm (WxHxD 1532 x 16/25 x 600 mm)

M 10								
K50 M10 Laminate 50 mm K005S Castell Oak K023P Stainless Steel Colour K039G Premium white glossy K039P Premium white K043P Graphite Black	K058P Magic-grey K075P Black K076P Macaron K160F Snow White K160G Snow White Gloss K178F White Agate	K190S Mammoth oak natural K199S Piemont Oak K216S natural mountain oak K218P Light Pepper K229S Classic Oak K230P Art Pepper	K235P Titan Steel K236S Diamond Oak effect K247S Dark Maron effect K248P Light Nude K262S Royal Oak effect K263P Fango	K269S Mountain Wood K270S Elegant walnut effect				

**ROOMBASE Base units**

Order no.  
W H D

Hinge side:	Carcase depth	Price groups								
		1	2	3	4	5	6	7	8	9
		200	209	232	282	302	317	347	382	-
		200	209	232	288	302	321	350	385	-
		200	209	232	288	302	321	350	385	-
		200	209	232	288	321	343	381	419	-
		233	245	262	326	372	395	437	481	-
		 Custom base units for combining with ROOMBASE								
		485	496	543	595	595	619	670	737	-
		485	496	543	595	595	619	670	737	-
		485	496	543	595	595	619	670	737	-
		485	496	543	595	595	619	670	737	-
		517	531	576	644	644	675	731	804	-
		 Custom base units for combining with ROOMBASE								

776 

**Base unit**  
1 door 77.6 cm  
2 adjustable shelves  
offset plinth blocks

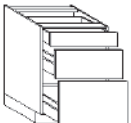
**RB U 30 78 55 70** R/L ▲

**RB U 40 78 55 70** R/L ▲

**RB U 45 78 55 70** R/L ▲

**RB U 50 78 55 70** R/L ▲

**RB U 60 78 55 70** R/L ▲

126  
256  
386 

**Base unit**  
1 drawer 12.6 cm  
1 pull-out 25.6 cm  
1 pull-out 38.6 cm  
offset plinth blocks

**RB U 30 78 55 12** ▲

**RB U 40 78 55 12** ▲

**RB U 45 78 55 12** ▲

**RB U 50 78 55 12** ▲

**RB U 60 78 55 12** ▲



### Planning advice:

Overall dimensions: B1500 H1120 T600

The element can only be used in combination with the defined dimensions (in order that the table can be swivelled fully)

The column must be connected to the island in the lower area on both sides via 16 mm panels or connecting carcasses!

The element is only possible with the fixed overall height

The element is designed for planning with:

carcase height: 78 cm

plinth height: 10 cm

The columns are panelled with 16 mm material or panels.

Restrictions for the turntable top:

One APD is to be planned per turntable top!

min. thickness: 2,5 cm

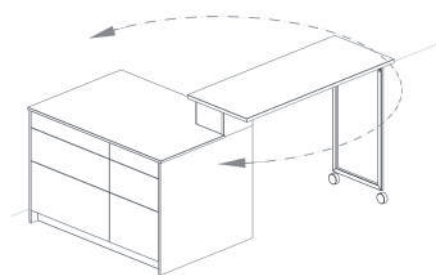
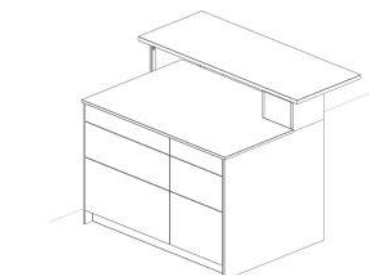
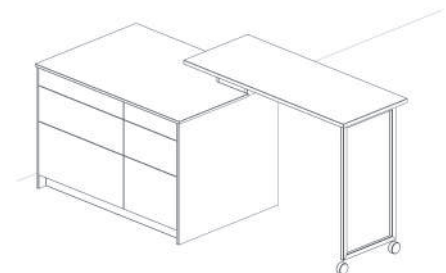
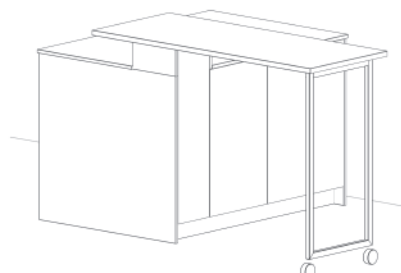
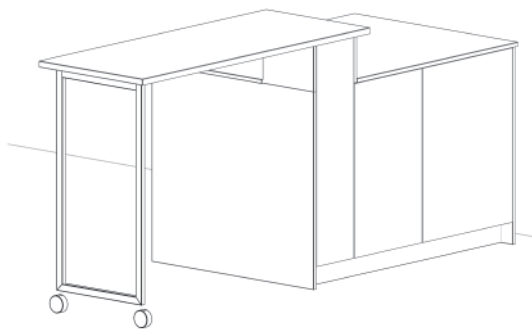
max. length: 150 cm

depth: 60 cm



### Design suggestion 1

- 1 U 80 78 55 12 base unit
- 1 U 50 78 55 12 base unit
- 1 PI-UDS 110 25 25 K PIROUETTE carousel shelf add-on kit
- 1 U 45 78 34 70 L base unit
- 1 U 60 78 34 70 R base unit
- 1 PI-DTS 110 49 FREESTYLE carousel shelf support frame
- 1 AP 25 D worktop, 150 x 60 cm
- 1 WS 16 panel, 94.2 x 88 cm
- 1 WS 16 panel, 94.2 x 88 cm
- 1 APD worktop, 162.5 x 98.5 cm
- 1 APD W 91 Worktop corner cutout, 90°, for PIROUETTE carousel shelf, add-on kit



Price groups									
1	2	3	4	5	6	7	8	9	

Order no.  
W H D

Hinge side:  
Carcase depth



**Add-on PIRouETTE carousel shelf set**  
consisting of:  
**1 base unit**  
for attaching the carousel shelf

**1 door and 1 fixed-position structural shelf**  
including 16mm shelf with carousel fitting

**1 panel 16 mm (WxHxD 210 x 250 x 16 mm)**  
for concealing the base-unit rear

**2 panels 16 mm (WxHxD 210 x 290 x 16 mm)**  
for concealing the base-unit sides

REGISTERED  
COMMUNITY  
DESIGN

PI-UDS11025 25 K	631	658	718	741	777	801	836	920	-
PI-UDS11025 25 D	641	669	727	750	787	811	847	932	-
PI-UDS11025 25 I	711	739	797	820	856	881	917	1009	-
PI-UDS11025 25 S	714	742	801	825	860	884	920	1012	-
PI-UDS11025 25 B	714	742	801	825	860	884	920	1012	-
PI-UDS11025 25 P	714	742	801	825	860	884	920	1012	-
PI-UDS11025 25 F	854	882	941	965	1000	1024	1060	1166	-
PI-UDS11025 25 Z	854	882	941	965	1000	1024	1060	1166	-
PI-UDS11025 25 H	890	919	977	1001	1037	1061	1096	1206	-
PI-UDS11025 25 M	890	919	977	1001	1037	1061	1096	1206	-
PI-UDS11025 25 O	890	919	977	1001	1037	1061	1096	1206	-
PI-UDS11025 25 A1	781	809	867	890	926	951	987	1086	-
PI-UDS11025 25 C	714	742	801	825	860	884	920	1012	-
PI-UDS11025 25 R	714	742	801	825	860	884	920	1012	-
PI-UDS11025 25 N	714	742	801	825	860	884	920	1012	-
PI-UDS11025 25 Q	714	742	801	825	860	884	920	1012	-
PI-UDS11025 25 A	714	742	801	825	860	884	920	1012	-
PI-UDS11025 25 L	714	742	801	825	860	884	920	1012	-
PI-UDS11025 25 C1	890	919	977	1001	1037	1061	1096	1206	-



Width 25 Not available for: MIAMI, VIVA



width 25 cm: FRAME are supplied with smooth fronts.



**FREESTYLE carousel shelf support**  
Support frame with casters for PIRouETTE carousel shelf (WxH 490 x 1095 mm)

REGISTERED  
COMMUNITY  
DESIGN

PI-DTS110 49	403								
--------------	-----	--	--	--	--	--	--	--	--

**Table-top size:**  
at least 25 mm thick  
at most 150 cm long  
x 60 cm deep  
Please order (APD.../AP25D...) tabletop separately.  
An end panel must be included when adding to an island corner - the depth depends on the island you are planning!  
The maximum dimension available to the right or left of the base unit carousel fitting is 1050 mm

M 10	M 20	M 30	M 40	M 50
K16 M10 Laminate	D16 M20 Laminate decor	I16 M30 RESOPAL PRO super matt IH16 M30 HPL PRO 16 mm PW16 M30 PRIMEWOOD/Basic Veneer	A16 M40 DIRECTLACK matt L16 M40 DIRECTLACK high-gloss,	B16 M50 Velvet lacquer 16 mm P16 M50 Soft lacquer, 16 mm R16H M50 Velvet lacquer wood texture R16W M50 Velvet lacquer spackle effect S16 M50 micro structured lacquer
M 60	M 70	M 80	M 90	
Q16H M60 SMARTGLAS high-gloss Q16M M60 SMARTGLAS satin-finish,	F16 M70 veneer / walnut / oak V16 M70 Velvet lacquer textured metallic Z16 M70 Veneer / Bavaria	C116 M80 FENIX stainless-steel look H16 M80 High gloss-Lacquer MP16 M80 Matt-Lacquer Premium O16 M80 veneer	A116 M90 Worktop decor	



# 7.4

## ALUELEMENTS

### ALU ELEMENTS

ALUELEMENTS base units	XL 7.4.1
ALUELEMENTS wall units	XL 7.4.1
ALUELEMENTS wall units	XL 7.4.1-XL 7.4.2
ALUELEMENTS NEW SPIN	XL 7.4.2-XL 7.4.3

#### Legend:



This symbol indicates which models are available



Planning advice



Merchandise net



available depths for wall-mounted units



wall-mounted units



Available carcass depths 34/45.5/55.5/61.0 cm



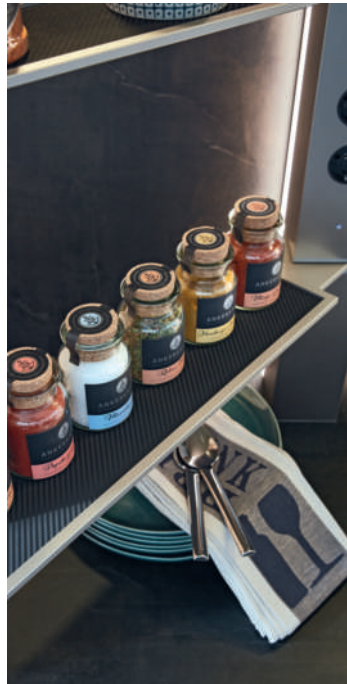
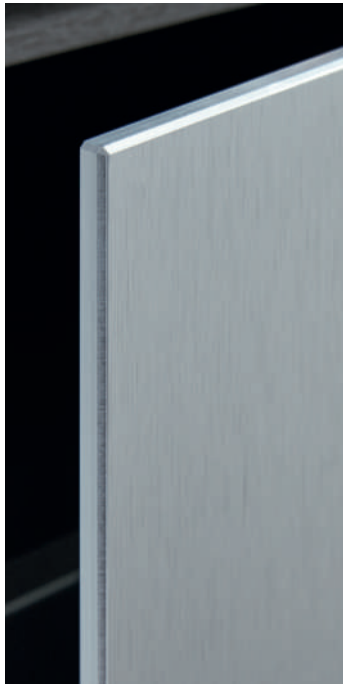
Available carcass depths 45.5/55.5/61.0 cm



Available carcass depths 55.5/61.0 cm



# ALU ELEMENTS



ALUELEMENTS



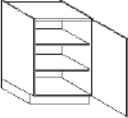
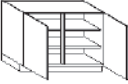
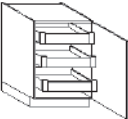
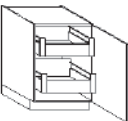
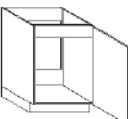
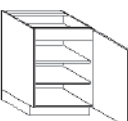
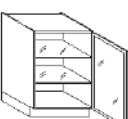
# ALUELEMENTS base units

Carcase height 78 cm

# ALU ELEMENTS

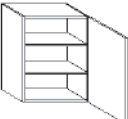
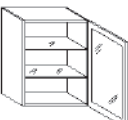
Order no.

W H D

	Hinge side:	Carcase depth	Price groups								
			1	2	3	4	5	6	7	8	9
<b>776</b>  <b>Base unit</b> 1 aluminium door 77.6 cm thickness 5 mm 2 adjustable shelves With „push to open“ fitting and closed top shelf	34,0 45,5 55,5 61,0	AL U 60 78 55 70 R/L ■	-	-	-	-	-	-	-	-	951
Available for: ALUELEMENTS available front finishes: 993 aluminium brushed, stainless steel-coloured 997 aluminium black brushed											
<b>776</b>  <b>Base unit</b> 2 aluminium doors 77.6 cm thickness 5 mm 2 adjustable shelves With „push to open“ fitting and closed top shelf	34,0 45,5 55,5 61,0	AL U 120 78 55 70 ■	-	-	-	-	-	-	-	-	1672
Available for: ALUELEMENTS available front finishes: 993 aluminium brushed, stainless steel-coloured 997 aluminium black brushed											
<b>776</b>  <b>Base unit</b> 1 aluminium door 77.6 cm thickness 5 mm 3 internal drawers With „push to open“ fitting and closed top shelf	34,0 45,5 55,5 61,0	AL U 60 78 55 73 R/L ■	-	-	-	-	-	-	-	-	1207
Available for: ALUELEMENTS available front finishes: 993 aluminium brushed, stainless steel-coloured 997 aluminium black brushed											
<b>776</b>  <b>Base unit</b> 1 aluminium door 77.6 cm thickness 5 mm 2 internal pull-outs With „push to open“ fitting and closed top shelf	34,0 45,5 55,5 61,0	AL U 60 78 55 74 R/L ■	-	-	-	-	-	-	-	-	1199
Available for: ALUELEMENTS available front finishes: 993 aluminium brushed, stainless steel-coloured 997 aluminium black brushed											
<b>776</b>  <b>Sink base unit</b> 1 aluminium door 77.6 cm thickness 5 mm 1 inside panel 1 aluminium protective shelf With „push to open“ fitting		AL US 60 78 55 701 R/L ▲	-	-	-	-	-	-	-	-	869
Available for: ALUELEMENTS available front finishes: 993 aluminium brushed, stainless steel-coloured 997 aluminium black brushed											
<b>776</b>  <b>Hob base unit</b> 1 aluminium door 77.6 cm thickness 5 mm 1 inside panel 1 cable protective shelf 2 adjustable shelves With „push to open“ fitting		AL UK 60 78 55 70 R/L ▲	-	-	-	-	-	-	-	-	851
Available for: ALUELEMENTS available front finishes: 993 aluminium brushed, stainless steel-coloured 997 aluminium black brushed											
<b>776</b>  <b>Base unit with glass front</b> 1 aluminium door 77.6 cm thickness 5 mm Clear glass 2 adjustable glass shelves With „push to open“ fitting and closed top shelf	34,0 45,5 55,5 61,0	AL UG 60 78 55 R/L ■	-	-	-	-	-	-	-	-	1199
Available for: ALUELEMENTS available front finishes: 993 aluminium brushed, stainless steel-coloured 997 aluminium black brushed  Note: For carcase depth 34 cm with wall mounting.											


# ALUELEMENTS wall units

Carcase height 78 cm

<b>776</b>  <b>Wall unit</b> 1 aluminium door 77.6 cm thickness 5 mm 2 adjustable shelves With „push to open“ fitting		AL H 60 78 3470 R/L	-	-	-	-	-	-	-	-	870
Available for: ALUELEMENTS available front finishes: 993 aluminium brushed, stainless steel-coloured 997 aluminium black brushed											
<b>776</b>  <b>Wall unit with glass front</b> 1 aluminium door 77.6 cm thickness 5 mm 2 adjustable glass shelves With „push to open“ fitting		AL HG 60 78 34 R/L	-	-	-	-	-	-	-	-	1055
Available for: ALUELEMENTS available front finishes: 993 aluminium brushed, stainless steel-coloured 997 aluminium black brushed											

# ALUELEMENTS wall units

Carcase height 91 cm


<b>906</b>  <b>Wall unit</b> 1 aluminium door 90.6 cm thickness 5 mm 3 adjustable shelves With „push to open“ fitting		AL H 60 91 34 70 R/L	-	-	-	-	-	-	-	-	919
Available for: ALUELEMENTS available front finishes: 993 aluminium brushed, stainless steel-coloured 997 aluminium black brushed											

**ALUELEMENTS wall units**  
Carcase height 91 cm

**ALU  
ELEMENTS**


Order no.  
W H D


Hinge side:	Carcase depth	Price groups								
		1	2	3	4	5	6	7	8	9
R/L		-	-	-	-	-	-	-	-	1107

906  **Wall unit with glass front**  
1 aluminium door 90.6 cm thickness 5 mm  
Clear glass  
2 adjustable glass shelves  
With „push to open“ fitting

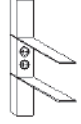
**AL HG 60 91 34**  
Available for:  
ALUELEMENTS  
available front finishes:  
993 aluminium brushed, stainless steel-coloured  
997 aluminium black brushed


**ALUELEMENTS NEW SPIN**

 **Spin column, with LED lighting throughout and 2 sockets, height 52 cm**  
consisting of  
1 fixed unit  
2 swivel arms  
1 adapter at top  
1 adapter at bottom  
1 full-width LED lighting strip, can be dimmed, Emotion, with integrated ballast/converter and cables  
2 jacks integrated in fixed unit  
cover caps at top and bottom  
  
Brushed aluminium, stainless steel-coloured  
Brushed aluminium, black

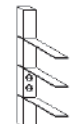
 height adjustments are made by shortening the adapters at top and bottom  
Emotion: infinitely variable colour temperature from warm white (3000 K) to cold white (6000 K), incl. dimming function


<b>AL SPIN 52 LED</b>	885
<b>AL SPIN 52 S LED</b>	885

 **Spin column, with LED lighting throughout and 2 sockets, height 78 cm**  
consisting of  
1 fixed unit  
2 swivel arms  
1 adapter at top  
1 adapter at bottom  
1 full-width LED lighting strip, can be dimmed, Emotion, with integrated ballast/converter and cables  
2 jacks integrated in fixed unit  
cover caps at top and bottom  
  
Brushed aluminium, stainless steel-coloured  
Brushed aluminium, black

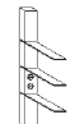
 height adjustments are made by shortening the adapters at top and bottom  
Emotion: infinitely variable colour temperature from warm white (3000 K) to cold white (6000 K), incl. dimming function


<b>AL SPIN 78 LED</b>	922
<b>AL SPIN 78 S LED</b>	922

 **Spin column, with LED lighting throughout and 2 sockets, height 113 cm**  
consisting of  
2 fixed units  
3 swivel arms  
1 adapter at top  
1 adapter at bottom  
1 full-width LED lighting strip, can be dimmed, Emotion, with integrated ballast/converter and cables  
2 jacks integrated in fixed unit  
cover caps at top and bottom  
  
Brushed aluminium, stainless steel-coloured  
Brushed aluminium, black

 height adjustments are made by shortening the adapters at top and bottom  
Emotion: infinitely variable colour temperature from warm white (3000 K) to cold white (6000 K), incl. dimming function




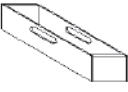
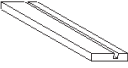
<b>AL SPIN 113 LED</b>	1122
<b>AL SPIN 113 S LED</b>	1122

 **Spin column, with LED lighting throughout and 2 sockets, height 126 cm**  
consisting of  
2 fixed units  
3 swivel arms  
1 adapter at top  
1 adapter at bottom  
1 full-width LED lighting strip, can be dimmed, Emotion, with integrated ballast/converter and cables  
2 jacks integrated in fixed unit  
cover caps at top and bottom  
  
Brushed aluminium, stainless steel-coloured  
Brushed aluminium, black

 height adjustments are made by shortening the adapters at top and bottom  
Emotion: infinitely variable colour temperature from warm white (3000 K) to cold white (6000 K), incl. dimming function

<b>AL SPIN 126 LED</b>	1149
<b>AL SPIN 126 SLED</b>	1149

# ALUELEMENTS NEW SPIN

		Hinge side:	Carcass depth	Price groups				
Order no. W H D				1				
 <p><b>Spin column, with LED lighting throughout and 2 sockets, height 139 cm</b>                      consisting of                      2 fixed units                      3 swivel arms                      1 adapter at top                      1 adapter at bottom                      1 full-width LED lighting strip, can be dimmed, Emotion, with integrated ballast/converter and cables                      2 jacks integrated in fixed unit                      cover caps at top and bottom</p> <p>Brushed aluminium, stainless steel-coloured                      Brushed aluminium, black</p>	 <p>height adjustments are made by shortening the adapters at top and bottom                      Emotion: infinitely variable colour temperature from warm white (3000 K) to cold white (6000 K), incl. dimming function</p>							
		<b>AL SPIN 139 LED</b>						1179
 <p><b>New Alu BOX</b>                      wall unit Box                      frame aluminium 8 mm                      rear with aluminium on particle board 8 mm                      W x H x D 60 x 39 x 18 cm</p> <p>Brushed aluminium, stainless steel-coloured                      Brushed aluminium, black</p>								
	<b>AL HR 60 3918</b>							493
 <p><b>Spin Pure Storebox</b>                      with aluminium panel suitable for <b>swivel arm</b>                      W x H x D 43 x 7 x 10 cm                      Narrow sides light oak                      Long sides aluminium with handle milling</p> <p>Brushed aluminium, stainless steel-coloured                      Brushed aluminium, black</p>								
	<b>AL PB 50 12</b>							133
 <p><b>Tray bracket</b>                      suitable for <b>swivel arm</b>                      Finish: real wood light oak                      W x H x D 43 x 2 x 10 cm</p>								
	<b>AL IP 50 15</b>							53



<b>FREESTYLE plinth frame for modular configurations</b>	XL 7.5.1
<b>Plinth module system FREESTYLE</b>	XL 7.5.2
<b>FREEWALL shelf system</b>	XL 7.5.3
<b>FREEWALL shelf system Design suggestions</b>	XL 7.5.4
<b>FREEWALL shelf system Stile elements</b>	XL 7.5.5-XL 7.5.6
<b>Design suggestions FREEBRIDGE</b>	XL 7.5.7
<b>FREEBRIDGE</b>	XL 7.5.8
<b>Design suggestions FREEMOBILE</b>	XL 7.5.9
<b>FREEMOBILE</b>	XL 7.5.10-XL 7.5.12
<b>FREEBOARD</b>	XL 7.5.12-XL 7.5.13
<b>Design suggestions Recess system</b>	XL 7.5.13
<b>Recess system</b>	XL 7.5.14
<b>Recess system Accessories</b>	XL 7.5.15-XL 7.5.16
<b>Design suggestions FREEELEMENTS Ballerina by Ars Nova</b>	XL 7.5.17
<b>FREEELEMENTS Ballerina by Ars Nova Height 100 cm including plinth base</b>	XL 7.5.18-XL 7.5.19
<b>FREEELEMENTS Ballerina by Ars Nova Height 160 cm including plinth base</b>	XL 7.5.19-XL 7.5.21
<b>FREEELEMENTS Ballerina by Ars Nova Height 240 cm including plinth base</b>	XL 7.5.21-XL 7.5.22

**Legend:**



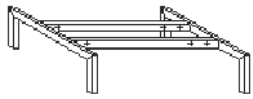
**Planning advice**



**Merchandise net**



FREEWORLD



**FREESTYLE plinth frame for modular configurations**

**width 60 cm**

suitable for carcass depth **45.5 / 55.5** cm

Finish black

height 15 cm

With height adjustment

Incl. floor attachment

Carcass depth 55.5 cm/61 cm

Carcass depth 45.5 cm



**Width 60 cm:** Braces as connectors between the U-frames with 2 drill holes each for attaching the unit (200 mm grid)

**MS 60 55 15**

**374**

**MS 60 45 15**

**371**



**FREESTYLE plinth frame for modular configurations**

**width 90 cm**

suitable for carcass depth **45.5 / 55.5** cm

Finish black

height 15 cm

With height adjustment

Incl. floor attachment

Carcass depth 55.5 cm/61 cm

Carcass depth 45.5 cm



**Width 90 cm:** Braces as connectors between the U-frames with 4 drill holes each for attaching the unit (200 mm grid)

**MS 90 55 15**

**378**

**MS 90 45 15**

**374**



**FREESTYLE plinth frame for modular configurations**

**width 120 cm**

suitable for carcass depth **45.5 / 55.5** cm

Finish black

height 15 cm

With height adjustment

From 120 cm width: additional support legs

Incl. floor attachment

Carcass depth 55.5 cm/61 cm

Carcass depth 45.5 cm



**Width 120 cm:** Braces as connectors between the U-frames with 6 drill holes each for attaching the unit (200 mm grid)  
1 brace with additional foot (20\*30 mm)

**MS 120 55 15**

**414**

**MS 120 45 15**

**411**



**FREESTYLE plinth frame for modular configurations**

**width 180 cm**

suitable for carcass depth **45.5 / 55.5** cm

Finish black

height 15 cm

With height adjustment

From 120 cm width: additional support legs

Incl. floor attachment

Carcass depth 55.5 cm/61 cm

Carcass depth 45.5 cm



**Width 180 cm:** Braces as connectors between the U-frames with 8 drill holes each for attaching the unit (200 mm grid)  
1 brace with additional foot (20\*30 mm)

**MS 180 55 15**

**422**

**MS 180 45 15**

**419**



**Support legs, set of 4, black, height 15 cm**

Finish steel black powder coated



for fitting on site

**FSF-SET**

**179**



**FREESTYLE centre support leg, black, height 15 cm**

Finish steel black powder coated

**Recommended: from 80 cm carcass width**



for fitting on site

**FSF-M**

**59**

*Finish:*

- U-frame, mitre-welded, ground and coated*
- With two retainers for cross-braces per runner (screwing from above)*
- With two height adjusters per runner*
- With bag of accessories (8 screws for cross-braces,*
- 1 anti-tilting safety device with screw and plug,*
- 2 brackets for wall mounting*
- 4 felt pads for height adjusters)*
- U-frame of 30 x 20 x 1.5 mm tubing*

**Planning advice:** Please do not plan dishwashers directly on the plinth frame.



# FREE WALL





# FREEWALL shelf system

FREE  
WALL

**FREEWALL** enables adaptation to a large number of living situations. Whether in the kitchen or living room, as a hallway version or even with clothes rails in a walk-in bedroom.

The materials used are the same as in the **FREESTYLE** plinth frame. Therefore, combinations of furniture elements on the **FREESTYLE** plinth modules and **FREEWALL** are perfect.

Flexible planning options with shelves, base units, wall units, tall units and LED lighting with Emotion technology round out this shelving system.

#### Material finish:

Steel, black, powder coated,  
Cross-section of a **FREEWALL** stile:  
width 20 mm, depth 30 mm

The adjustable foot enables height compensation.

Available dimensions for **FREEWALL** stile elements

Top-mount stile element

height: 1100 mm

depth: 180 mm

Functional rail for hanging kitchen utensils – can be combined with the 180 mm deep

#### Stile element

Height:	2000 mm	
Depth:	180 mm	290 mm
Clothes rails:	600 mm	900 mm

Unit widths: 300 - 900 mm

Shelves 16 mm in widths of 300 to 900 mm

Shelves 19 mm in widths of 300 to 900 mm

(we recommend 19 mm material for shelves wider than 600 mm)



#### Flexible planning options:

The extensive range of models extends from shelves and clothes rails through to wall-mounted base units, wall units and tall units.

The **base units** - for planning between two **FREEWALL** stile elements - are equipped with **heavy-load fittings** and **have to be attached to the wall**.

All unit types marked with the symbol



for (wall-hung units) can be planned with **FREEWALL** (not possible with floor-standing unit models).

For securing the planned unit types, a **shelf and unit top-mount set** (FSW-BSET) is available, which is automatically confirmed and delivered at an extra charge.

Shelves and units must be mounted with the **shelf and unit top-mount set** (FSW-BSET)

which will also be automatically confirmed and delivered at an extra charge

Furthermore, wall units with a carcass depth of 339 mm and in all heights can be planned between the **FREEWALL** stiles.

The unit elements are to be found in the respective sections (base units, wall units and tall units).

#### Planning advice:

##### Planning advice for FreeWall stile element 180 mm depth

Shelf to wall: minimum depth 230 mm

Shelf up to the wall with the same projection at the front and rear: 330 mm

Shelf with 20 mm clearance to the wall and the same projection at the front and rear: 290 mm

maximum depth 380 mm, maximum width 900 mm

##### Planning advice for FreeWall stile element 290 mm depth

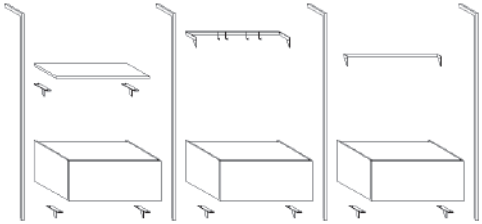
Shelf to wall: minimum depth 340 mm

Shelf up to the wall with the same projection at the front and rear: 550 mm

Shelf with 20 mm clearance to the wall and the same projection at the front and rear: 510 mm

maximum depth 600 mm, maximum width 900 mm

1880



20 ..... 600 ..... 20 ..... 600 ..... 20 ..... 600 ..... 20

## Design suggestion 1

### consisting of:

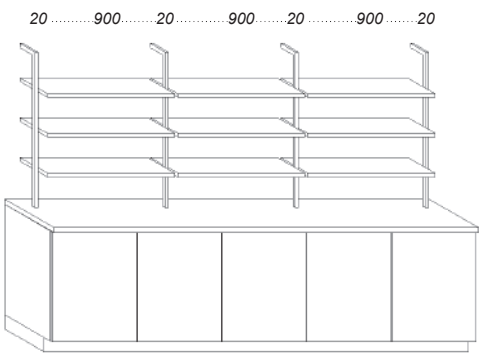
- 4 x FSWS 200 29 FREEWALL stile element
- 4 x FSW-LEDP 200 LED lighting profile Emotion, approx. 13.7 W per profile
- 2 x FSW-KS60 garment rail 60 cm
- 1 x WBS16 panel shelf as shelf
- 1 x FSW-BSET Shelf and unit top-mount set
- 3 x U 60 39 55 01 base unit 60 cm wide, 1 pull-out
- 3 x FSW-BSET Shelf and unit top-mount set
- 3 x WBS16 panel shelf for base units
- 3 X MP-WST extra price for wall-mounted units



### Must be planned:

Starter set **LED4-ASET60/LED-ASET60 or LED-ASET60FB**

2780



20 ..... 900 ..... 20 ..... 900 ..... 20 ..... 900 ..... 20

## Design suggestion 2

### consisting of:

- 4 x FSWAS 110 18 FREEWALL top-mount stile element
- 4 x FSW-LEDP 110 LED lighting profile, approx. 7.2 W per profile
- 9 x FSW-BSET Shelf and unit top-mount set
- 9 x WBS19 panel shelf as shelf

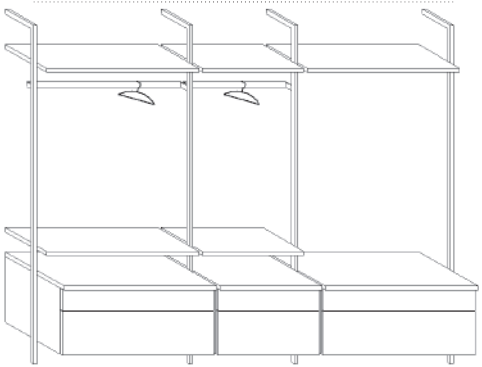
Please order base unit and work top separately.



### Must be planned:

Starter set **LED4-ASET60/LED-ASET60 or LED-ASET60FB**

2480



20 ..... 900 ..... 20 ..... 600 ..... 20 ..... 900 ..... 20

## Design suggestion 3

### consisting of:

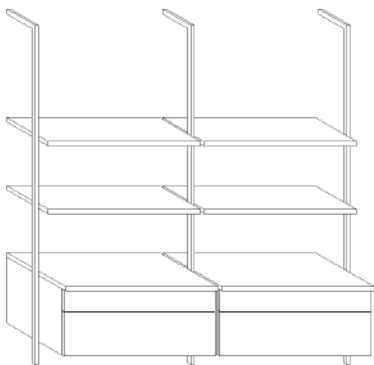
- 4 x FSWS 200 29 FREEWALL stile element
- 4 x FSW-LEDP 200 LED lighting profile, approx. 13.7 W per profile
- 1 x FSW-KS60 garment rail 60 cm
- 1 x FSW-KS90 garment rail 90 cm
- 2 x U 90 39 55 11 base unit 90 cm wide, 1 drawer, 1 pull-out
- 1 x U 60 39 55 11 base unit 60 cm wide, 1 drawer, 1 pull-out
- 5 x WBS19 panel shelf as shelf
- 5 x FSW-BSET Shelf and unit top-mount set
- 3 x WBS16 panel shelf for base units
- 3 x MP-WST extra price for wall-mounted units
- 3 x FSW-BSET Shelf and unit top-mount set



### Must be planned:

Starter set **LED4-ASET60/LED-ASET60 or LED-ASET60FB**

1860



20 ..... 900 ..... 20 ..... 900 ..... 20

## Design suggestion 4

### consisting of:

- 3 x FSWS 200 29 FREEWALL stile element
- 3 x FSW-LEDP 200 LED lighting profile, approx. 13.7 W per profile
- 4 x FSW-BSET Shelf and unit top-mount set
- 4 x WBS19 panel shelf as shelf
- 2 x U 90 39 55 11 base unit 90 cm wide, 1 drawer, 1 pull-out
- 2 x FSW-BSET Shelf and unit top-mount set
- 2 x WBS16 panel shelf for base units
- 2 x MP-WST extra price for wall-mounted units



### Must be planned:

Starter set **LED4-ASET60/LED-ASET60 or LED-ASET60FB**



**FREEWALL Top-mount stile element 1100/180**  
 Finish steel black powder coated  
 Grid for the suspension points: 65 mm  
 incl. mounting and fixing material (wall-mounting at top,  
 adapter plate  
 with screws for affixing to a worktop)

**FSWAS110 18**

**179**

Width 20 mm  
 Height 1100 mm  
 Depth 180 mm



**LED lighting profile Bali for stile element, approx. 7.2 W**  
 incl. end caps, 2 m connection lead and cable brackets,  
 equipped with screws  
 for affixing on the rear of the stile elements, cable exit at  
 the end, the profile can be turned,  
 therefore the cable can exit both upwards and downwards.  
 Light emotion: infinitely variable colour temperature from  
 warm white (2700 K) to cold white (6000 K)

REGISTERED  
COMMUNITY  
DESIGN



**Must be planned:**  
 Starter set **LED4-ASET60, LED-ASET60FB or LED-ASET60**

**Note:** When planning with an LED lighting profile a shelf  
 or unit must also be planned in order that the  
 converter/distributor can be affixed.

**FSW-LEDP 110**

**96**



**FREEWALL stile element 2000/180**  
 Finish steel black powder coated  
 Grid for the suspension points: 65 mm  
 first point of hanging in 100 mm from bottom  
 incl. mounting and fixing material (wall-mounting at top)

REGISTERED  
COMMUNITY  
DESIGN



**Planning advice:**  
 When planning without unit elements, at least 1 shelf must be  
 planned below via which the system can be secured to the wall  
 to prevent moving.  
 A wall fixing bracket included with every stile element is  
 necessary for this (apart from top-mount stile elements).

**FSWS200 18**

**205**

Width 20 mm  
 Height 2000 mm  
 Depth 180 mm



**LED lighting profile Bali for stile element, approx. 13.7 W**  
 incl. end caps, 2 m connection lead and cable brackets,  
 equipped with screws  
 for affixing on the rear of the stile elements, cable exit at  
 the end, the profile can be turned,  
 therefore the cable can exit both upwards and downwards.  
 Light emotion: infinitely variable colour temperature from  
 warm white (2700 K) to cold white (6000 K)

REGISTERED  
COMMUNITY  
DESIGN



**Must be planned:**  
 Starter set **LED4-ASET60, LED-ASET60FB or LED-ASET60**

**Note:** When planning with an LED lighting profile a shelf  
 or unit must also be planned in order that the  
 converter/distributor can be affixed.

**FSW-LEDP 200**

**138**



**FREEWALL Stile element 2000/290**

Finish steel black powder coated  
Grid for the suspension points: 65 mm  
first point of hanging in 100 mm from bottom  
incl. mounting and fixing material (wall-mounting at top)

REGISTERED  
COMMUNITY  
DESIGN



**Planning advice:**

*When planning without unit elements, at least 1 shelf must be planned below via which the system can be secured to the wall to prevent moving.  
A wall fixing bracket included with every stile element is necessary for this (apart from top-mount stile elements).*

**FSWS200 29**

**206**

Width 20 mm  
Height 2000 mm  
Depth 290 mm



**LED lighting profile Bali for stile element, approx. 13.7 W**

incl. end caps, 2 m connection lead and cable brackets, equipped with screws  
for affixing on the rear of the stile elements, cable exit at the end, the profile can be turned, therefore the cable can exit both upwards and downwards.  
Light emotion: infinitely variable colour temperature from warm white (2700 K) to cold white (6000 K)

REGISTERED  
COMMUNITY  
DESIGN



**Must be planned:**

**Starter set LED4-ASET60, LED-ASET60FB or LED-ASET60**

**Note:** *When planning with an LED lighting profile a shelf or unit must also be planned in order that the converter/distributor can be affixed.*

**FSW-LEDP 200**

**138**



**Shelf and unit top-mount set**

Finish steel black powder coated  
consisting of left and right substrates  
incl. anti-lift retainer and screws  
for affixing shelves and units

Length: 200 mm



**Note:**

*Mounting by hanging in FREEWALL stile element*

**FSW-BSET**

**75**



**Garment rail**

Finish steel black powder coated  
incl. anti-lift retainer

Width 60 cm

Width 90 cm



**Note:** *Can only be combined with article FSWS 200 29*

**FSW-KS60**

**112**

**FSW-KS90**

**122**



**Aperture rail**

Finish steel black powder coated  
incl. anti-lift retainer

Width 60 cm

Width 90 cm

REGISTERED  
COMMUNITY  
DESIGN

**FSW-NR60**

**114**

**FSW-NR90**

**120**



**Hook set for aperture rail**

Finish steel black powder coated

REGISTERED  
COMMUNITY  
DESIGN

**FSW-NRH**

**25**



**Planning information for FREEBRIDGE FBR 66 18 (width 660 mm)**

Dimensions of the base for insertion over the entire surface: (WxD) 609 x 137 x 16 mm

Dimensions of the base for insertion in a combination e.g. with the box FBR BOX 14: (WxD) 472 x 137 x 16 mm

**Planning information for FREEBRIDGE FBR 100 18 (width 995 mm)**

Dimensions of the base for insertion over the entire surface: (WxD) 944 x 137 x 16 mm

Dimensions of the base for insertion in a combination e.g. with the box FBR BOX 14: (WxD) 472 x 137 x 16 mm



**Design suggestion 1**

consisting of:

Merchandise net

**FREEBRIDGE**  
function element 660 mm  
Knife block for FREEBRIDGE

FBR 66 18 243

FBR MBE 47 112

Box with surround for dropping in  
for FREEBRIDGE

FBRBOXE 14 82



**Design suggestion 2**

consisting of:

Merchandise net

**FREEBRIDGE**  
function element 995 mm  
Box with surround for dropping in  
for FREEBRIDGE

FBR 100 18 248

FBRBOXE 14 82

Box with surround for dropping in  
for FREEBRIDGE

FBRBOXE 47 85



**Plus:**

End-panel shelf 16 mm in customised size

Dimensions (W x D x H) 335 x 137 x 16 mm

pro m², B x D

**WBS 16**  
minimum price

M10	M20	M30	M40	M50	M60	M70	M80	M90
84	143	324	432	432	432	612	793	173
47	50	73	74	74	74	121	134	96



**Design suggestion 3**

consisting of:

Merchandise net

**FREEBRIDGE**  
function element 995 mm  
Spice rack for FREEBRIDGE

FBR 100 18 248

FBR GBE 47 59

Stainless steel oil pan  
for vinegar and oil bottles  
suitable for FREEBRIDGE

FBROEW 47 44



**Design suggestion 4**

consisting of:

Merchandise net

**FREEBRIDGE**  
function element 995 mm  
Foil dispenser suitable for  
FREEBRIDGE  
Box with surround for dropping in  
for FREEBRIDGE

FBR 100 18 248

FBR RHE 47 142

FBRBOXE 47 85



**Design suggestion 5**

consisting of:

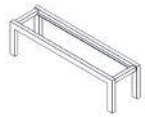
Merchandise net

**FREEBRIDGE**  
function element 995 mm  
Tray bracket suitable  
for FREEBRIDGE  
Box with surround for dropping in  
for FREEBRIDGE

FBR 100 18 248

FBR THE 47 66

FBRBOXE 47 85



**FREEBRIDGE**  
**function element 660 mm**  
 Finish: Steel black powder coated  
 Dimensions: (W x H x D) 660 x 180 x 178 mm  
 Interior dimensions: (W x D) 610 x 138  
 Finish: Steel black powder coated

REGISTERED  
COMMUNITY  
DESIGN

**FBR 66 18**

243

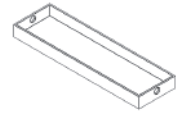


**FREEBRIDGE**  
**function element 995 mm**  
 Finish: Steel black powder coated  
 Dimensions: (W x H x D) 995 x 180 x 178 mm  
 Interior dimensions: (W x D) 945 x 138  
 Finish: Steel black powder coated

REGISTERED  
COMMUNITY  
DESIGN

**FBR 100 18**

248



**Spice rack for FREEBRIDGE**  
 Dimensions: (W x H x D) 472 x 43 x 137 mm  
 Finish: Real wood ash dark  
 Finish: real wood light oak

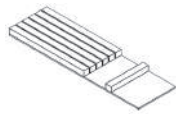
REGISTERED  
COMMUNITY  
DESIGN

**FBR GB 47**

59

**FBR GBE 47**

59



**Knife block for FREEBRIDGE**  
 Dimensions: (W x H x D) 472 x 26 x 137 mm  
 Finish: Real wood ash dark  
 Finish: real wood light oak

REGISTERED  
COMMUNITY  
DESIGN

**FBR MB 47**

112

**FBR MBE 47**

112



**Box with surround for dropping in for FREEBRIDGE**  
 Dimensions: (W x H x D) 137 x 147 x 137 mm  
 Finish: Real wood ash dark  
 Finish: real wood light oak

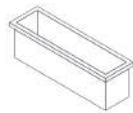
REGISTERED  
COMMUNITY  
DESIGN

**FBR BOX 14**

82

**FBRBOXE 14**

82



**Box with surround for dropping in for FREEBRIDGE**  
 Dimensions: (W x H x D) 472 x 147 x 137 mm  
 Finish: Real wood ash dark  
 Finish: real wood light oak

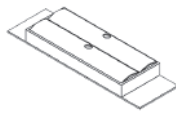
REGISTERED  
COMMUNITY  
DESIGN

**FBR BOX 47**

85

**FBRBOXE 47**

85



**Foil dispenser suitable for FREEBRIDGE**  
 Dimensions: (W x D) 472 x 137 mm  
 Finish: Real wood ash dark  
 Finish: real wood light oak

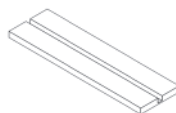
REGISTERED  
COMMUNITY  
DESIGN

**FBR RH 47**

142

**FBR RHE 47**

142



**Tray bracket suitable for FREEBRIDGE**  
 Dimensions: (W x D) 472 x 137 mm  
 Finish: Real wood ash dark  
 Finish: real wood light oak

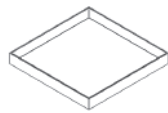
REGISTERED  
COMMUNITY  
DESIGN

**FBR TH 47**

66

**FBR THE 47**

66



**Stainless steel oil pan for vinegar and oil bottles suitable for FREEBRIDGE**  
 Dimensions: (W x D) 137 x 137 mm  
 Dimensions: (W x D) 472 x 137 mm

REGISTERED  
COMMUNITY  
DESIGN

**FBROEW 14**

28.60

**FBROEW 47**

44



**Spice rack for FREEBRIDGE**  
 Dimensions: (W x H x D) 472 x 43 x 137 mm  
 Finish: steel, powder-coated in black

REGISTERED  
COMMUNITY  
DESIGN

**FBR GE 47**

78



**Stacking box for spices**  
 Dimensions: (W x H x D) 489 x 116 x 156  
 Finish: Real wood ash dark  
 Finish: real wood light oak

**STBOX49**

139

**STBOXE49**

139





Planning information for FREEMOBILE FMOB 52 51 84  
 Dimensions of the base for insertion over the entire surface: (WxDxH) 472 x 472 x 16 mm  
 Planning tip: Smaller floors are also possible - but one side must always be at least 472 mm long

**Planning information for FREEMOBILE FMOB 52 51 84**

Dimensions of the base for insertion over the entire surface: (WxDxH) 472 x 472 x 16 mm  
 Planning tip: Smaller floors are also possible - but one side must always be at least 472 mm long



**Design suggestion 1**

consisting of:

Merchandise net

<b>FREEMOBILE mobile trolley</b>	<b>FMOB 52 51 84</b>	<b>627</b>
<b>Compensation box for FREEMOBILE</b>	<b>FMOBABE20</b>	<b>67</b>
<b>Storage box for FREEMOBILE</b>	<b>FMOBABOXE 47</b>	<b>144</b>
<b>Interior dividers for FREEMOBILE storage box</b>	<b>FMOBABOXE IE</b>	<b>115</b>
<b>Knife block for FREEMOBILE</b>	<b>FMOBMBE47</b>	<b>112</b>
<b>Box with surround for dropping in for FREEMOBILE</b>	<b>FMOBBOXE 47</b>	<b>85</b>



**Design suggestion 2**

consisting of:

Merchandise net

<b>FREEMOBILE mobile trolley</b>	<b>FMOB 52 51 84</b>	<b>627</b>
<b>Box with surround for dropping in for FREEMOBILE</b>	<b>FMOBBOXE 47</b>	<b>85</b>



**Plus:**

End-panel shelf 16 mm in customised size  
 Dimensions (W x D x H) 472 x 335 x 16 mm

per m<sup>2</sup>, H x D

**WS 16**  
 minimum price

M10	M20	M30	M40	M50	M60	M70	M80	M90
84	143	324	432	432	432	612	793	173
47	50	73	74	74	121	134	134	96



**Design suggestion 3**

consisting of:

Merchandise net

<b>FREEMOBILE mobile trolley</b>	<b>FMOB 52 51 84</b>	<b>627</b>
<b>Spice rack for FREEMOBILE</b>	<b>FMOBGBE47</b>	<b>59</b>
<b>Box with surround for dropping in for FREEMOBILE</b>	<b>FMOBBOXE 47</b>	<b>85</b>










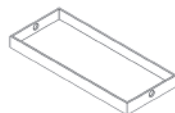
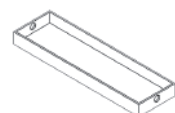
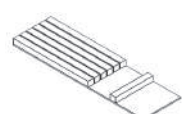
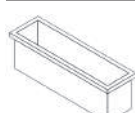
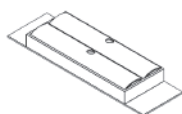
**Plus:**

End-panel shelf 16 mm in customised size  
 Dimensions (W x D x H) 472 x 198 x 16 mm

per m<sup>2</sup>, H x D

**WS 16**  
 minimum price

M10	M20	M30	M40	M50	M60	M70	M80	M90
84	143	324	432	432	432	612	793	173
47	50	73	74	74	121	134	134	96

	<p><b>FREEMOBILE mobile trolley</b>                      Finish: Steel black powder coated                      incl. 4 high-quality rollers                      Overall height: 840 mm                      Dimensions: (W x H x D) 519 x 840 x 513 mm                      Dimensions: (W x H x D) 519 x 840 x 513 mm</p>	<p>REGISTERED COMMUNITY DESIGN</p> 	<p><i>Note: For storage, the FREEMOBILE mobile trolley needs a 60 cm wide aperture.</i></p>	<p><b>FMOB 52 51 84</b> <span style="border: 1px solid black; padding: 2px;">627</span></p>
	<p><b>FREEMOBILE mobile trolley</b>                      Finish: Steel black powder coated                      incl. 4 high-quality rollers                      Overall height: 840 mm                      Dimensions: (W x H x D) 519 x 840 x 513 mm                      consisting of:                      FMOB 52 51 84                      FMOB HL 44                      FMOBABOX 47                      FMOBABOX IE                      FMOBAB 20                      FMOBBOXL 47                      FMOBMB 47                      FMOB JL GBA 47                      FMOB JL SBL                      Dimensions: (W x H x D) 519 x 840 x 513 mm</p>	<p>REGISTERED COMMUNITY DESIGN</p> 	<p><i>Note: For storage, the FREEMOBILE mobile trolley needs a 60 cm wide aperture.</i></p>	<p><b>FMOB JL 52 51 84</b> <span style="border: 1px solid black; padding: 2px;">1962</span></p>
	<p><b>FREEMOBILE mobile trolley</b>                      Finish: Steel black powder coated                      incl. 4 high-quality rollers                      Overall height: 840 mm                      Dimensions: (W x H x D) 519 x 840 x 513 mm                      consisting of:                      FMOB 52 51 84                      FMOB HL 44                      FMOBABOXE 47                      FMOBABOXE IE                      FMOBABE 20                      FMOBBOXLE 47                      FMOBMBE 47                      FMOB JL GBA 47                      FMOB JL SBL                      Dimensions: (W x H x D) 519 x 840 x 513 mm</p>	<p>REGISTERED COMMUNITY DESIGN</p> 	<p><i>Note: For storage, the FREEMOBILE mobile trolley needs a 60 cm wide aperture.</i></p>	<p><b>FMOBJLE 52 51 84</b> <span style="border: 1px solid black; padding: 2px;">1962</span></p>
	<p><b>Chopping board/tray for FREEMOBILE</b>                      Finish: Oiled oak                      Dimensions: (W x H x D) 513 x 530 x 52 mm</p>	<p>REGISTERED COMMUNITY DESIGN</p>	<p><b>FMOBSB</b></p>	<p><span style="border: 1px solid black; padding: 2px;">427</span></p>
	<p><b>Compensation box for FREEMOBILE</b>                      Dimensions: (W x H x D) 472 x 43 x 198 mm                      Finish: Real wood ash dark                      Finish: real wood light oak</p>	<p>REGISTERED COMMUNITY DESIGN</p>	<p><b>FMOBAB 20</b> <b>FMOBABE20</b></p>	<p><span style="border: 1px solid black; padding: 2px;">67</span> <span style="border: 1px solid black; padding: 2px;">67</span></p>
	<p><b>Spice rack for FREEMOBILE</b>                      Dimensions: (W x H x D) 472 x 43 x 137 mm                      Finish: Real wood ash dark                      Finish: real wood light oak</p>	<p>REGISTERED COMMUNITY DESIGN</p>	<p><b>FMOBGB 47</b> <b>FMOBGBE47</b></p>	<p><span style="border: 1px solid black; padding: 2px;">59</span> <span style="border: 1px solid black; padding: 2px;">59</span></p>
	<p><b>Knife block for FREEMOBILE</b>                      Dimensions: (W x H x D) 472 x 26 x 137 mm                      Finish: Real wood ash dark                      Finish: real wood light oak</p>	<p>REGISTERED COMMUNITY DESIGN</p>	<p><b>FMOBMB 47</b> <b>FMOBMBE47</b></p>	<p><span style="border: 1px solid black; padding: 2px;">112</span> <span style="border: 1px solid black; padding: 2px;">112</span></p>
	<p><b>Box with surround for dropping in for FREEMOBILE</b>                      Dimensions: (W x H x D) 472 x 147 x 137 mm                      Finish: Real wood ash dark                      Finish: real wood light oak</p>	<p>REGISTERED COMMUNITY DESIGN</p>	<p><b>FMOBBOX 47</b> <b>FMOBBOXE 47</b></p>	<p><span style="border: 1px solid black; padding: 2px;">85</span> <span style="border: 1px solid black; padding: 2px;">85</span></p>
	<p><b>Foil dispenser suitable for FREEMOBILE</b>                      Dimensions: (W x D) 472 x 137 mm                      Finish: Real wood ash dark                      Finish: real wood light oak</p>	<p>REGISTERED COMMUNITY DESIGN</p>	<p><b>FMOBRH 47</b> <b>FMOBRHE 47</b></p>	<p><span style="border: 1px solid black; padding: 2px;">142</span> <span style="border: 1px solid black; padding: 2px;">142</span></p>

	<p><b>Tray bracket suitable for FREEMOBILE</b>                  Dimensions: (W x D) 472 x 137 mm                  Finish: Real wood ash dark                  Finish: real wood light oak</p>	<p>REGISTERED COMMUNITY DESIGN</p>	<p><b>FMOB TH 47</b> <span style="float: right;">66</span>  <b>FMOBTHE47</b> <span style="float: right;">66</span></p>	<p>66 66</p>
	<p><b>Gastro container dresser unit suitable for FREEMOBILE</b>                  Dimensions: (W x D) 513 x 200 mm suitable for one Gastro container 1/6 (176 x 162 mm) and three containers 1/9 (176 x 108 mm)                   Finish: Real wood ash dark                  Finish: real wood light oak</p>	<p><i>Note: only in combination with chopping board FMOB JL SBL</i></p>	<p><b>FMOB JL GAB47</b> <span style="float: right;">314</span>  <b>FMOB JL GBAE47</b> <span style="float: right;">314</span></p>	<p>314 314</p>
	<p><b>Chopping board/tray for FREEMOBILE</b>                  Finish: Oiled oak                  Dimensions: (W x H x D) 513 x 328 x 52 mm</p>	<p><i>Note: only in combination with Gastro container dresser unit FMOB GBA...</i></p>	<p><b>FMOB JL SBL</b> <span style="float: right;">381</span></p>	<p>381</p>
	<p><b>Box with surround for dropping in for FREEMOBILE</b>                  Dimensions: (W x H x D) 472 x 247 x 137 mm                  Finish: Real wood ash dark                  Finish: real wood light oak</p>	<p>REGISTERED COMMUNITY DESIGN</p>	<p><b>FMOBBOXL 47</b> <span style="float: right;">155</span>  <b>FMOBBOXL E 47</b> <span style="float: right;">155</span></p>	<p>155 155</p>
	<p><b>Stainless steel oil pan for vinegar and oil bottles suitable for FREEMOBILE</b>                  Dimensions: (W x D) 472 x 137 mm</p>	<p>REGISTERED COMMUNITY DESIGN</p>	<p><b>FMOBOEW 47</b> <span style="float: right;">44</span></p>	<p>44</p>
	<p><b>Insert tray suitable for FREEMOBILE</b>                  Dimensions: (W x D) 472 x 472 mm without edge, not for the frame set for hooking in as additional level                   Finish: Real wood ash dark                  Finish: real wood light oak</p>	<p>REGISTERED COMMUNITY DESIGN</p> <p> <i>not for the frame set for hooking in as additional level</i></p>	<p><b>FMOBEB 47</b> <span style="float: right;">59</span>  <b>FMOBEBE47</b> <span style="float: right;">59</span></p>	<p>59 59</p>
	<p><b>Hook strip with 7 hooks suitable for FREEMOBILE</b>                  Incl. Mounting material                  Dimensions: (WxH) 439 x 30 mm</p>	<p>REGISTERED COMMUNITY DESIGN</p>	<p><b>FMOB HL 44</b> <span style="float: right;">42</span></p>	<p>42</p>
	<p><b>Frame set for hooking in as additional level</b>                  Finish: steel, powder-coated in black                  Distance from floor for FMOB RSE 47                  Item number: WS 16                  End-panel shelf in customised size, 472 x 472 x 16 mm</p>	<p>REGISTERED COMMUNITY DESIGN</p>	<p><b>FMOBRSE47</b> <span style="float: right;">170</span></p>	<p>170</p>
	<p><b>Multifunction box for FREEMOBILE with lid</b>                  for FREEMOBILE for hooking into top cross stay                  Also suitable for hooking onto kitchen fronts in a thickness of up to 22 mm.                  Do not use in conjunction with finger pulls.                  Colour finish: grey                  Volume: 4.2 l                  Dimensions: 170 x 227 x 172 mm</p>	<p>REGISTERED COMMUNITY DESIGN</p>	<p><b>FMOBMBOX</b> <span style="float: right;">19.50</span></p>	<p>19.50</p>
	<p><b>Spice rack for FREEMOBILE</b>                  Dimensions: (W x H x D) 472 x 43 x 137 mm                  Finish: steel, powder-coated in black</p>	<p>REGISTERED COMMUNITY DESIGN</p>	<p><b>FMOBGE 47</b> <span style="float: right;">78</span></p>	<p>78</p>

# FREEMOBILE

# FREE MOBILE

Order no.

Price



### Storage box for FREEMOBILE

can be planned e.g. along the entire lower level  
Sides solid, base veneered  
Dimensions: (W x H x D) 472 x 100 x 472 mm  
Finish: Real wood ash dark  
Finish: real wood light oak

REGISTERED  
COMMUNITY  
DESIGN

**FMOBABOX 47**

150

**FMOBABOXE 47**

144



### Interior dividers for FREEMOBILE storage box

suitable for 25 bottles  
solid design  
Dimensions: (W x H x D) 451 x 60 x 451 mm  
Finish: Real wood ash dark  
Finish: real wood light oak

REGISTERED  
COMMUNITY  
DESIGN

**FMOBABOX IE**

115

**FMOBABOXE IE**

115

## FREEBOARD

### FREEBOARD

#### Function profile, 2-piece

consisting of:  
1 base profile, unfinished  
1 function profile black anodised  
Available lengths: 100 cm, 150 cm, 200 cm and up to 400 cm  
Fixed length: 100 cm  
Fixed length: 150 cm  
Fixed length: 200 cm  
variable designs  
variable to 200 cm  
variable to 300 cm  
variable to 400 cm



**FB FP 100**

131

**FB FP 150**

165

**FB FP 200**

195

**FB FPV 200**

205

**FB FPV 300**

261

**FB FPV 400**

339

### FREEBOARD

#### Function profile, 2-part, with LED lighting

consisting of:  
1 base profile, unfinished  
1 function profile black anodised  
Available lengths: 100 cm, 150 cm, 200 cm and up to 400 cm  
1 LED strip 120+120 LED s/m Emotion 2700-6500 K, 7.2 W/m  
Fixed length: 100 cm  
Fixed length: 150 cm  
Fixed length: 200 cm  
variable to 200 cm  
variable to 300 cm  
variable to 400 cm



The function profiles can be combined in any existing LED system (1-channel and 4-channel system), easi system. Alternatively, you can use the FB EBOX energy box.

**FB FP LED 100**

232

**FB FP LED 150**

320

**FB FP LED 200**

386

**FB FPV LED 200**

397

**FB FPV LED 300**

602

**FB FPV LED 400**

690

### energy-box FREEBOARD

for function profiles with FB FP LED... LED lighting  
1 power socket / 1 USB port  
including LED-ASET60FB 1-channel starter set  
Width: 35 cm  
Stainless steel cover  
Finish: black



Note: the energy box is factory-connected to the function profile (10 cm from the left). Cabling is also fed out on the left.

**FB EBOX**

442

### Hook-in profile

including non-slip mat  
as standing surface or base for  
FBR GB 47 / 47/FBR GBE 47 spice box  
FBR MB 47 / FBR MBE 47 knife block  
FBR TH 477 / FBR THE 47 tablet holder  
from the FREEWORLD collection  
Width: 47,2 cm  
Width: 25 cm



**FB EPEM 47**

107

**FB EPEM 25**

72

### Hook-in profile set for shelf

consisting of:  
2 hook-in profiles, 5 cm wide  
Recommended shelf: depth 14 cm  
Max. width 40 cm  
Please order shelf separately (WBS 16)



**FB EPRB 25**

59



**Set of storage hooks**  
 consisting of:  
 5 storage hooks  
 anodised  
 Width per hook: 1.2 cm

**FB EPHL 5**

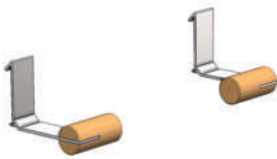
50



**Hook-in profile for glasses**  
 including non-slip mat  
 2 recessed jar holders  
 Width: 20 cm

**FB EPGL 20**

91



**Set of hook-in profiles for kitchen paper**  
 consisting of:  
 2 hook-in profiles, 5 cm wide  
 with spindles for kitchen towel rolls

**FB EPKR 20**

62

# Design suggestions Recess system



Design your kitchen to your personal taste with our versatile panel system.

It enables the design of recesses and entire walls and is an aesthetically pleasing and at the same time practical solution.

The black aluminium wall profiles are suitable for recess back panels made of 16 mm thick wood, plastic or lacquer.

The panels are attached via the aluminium profiles.

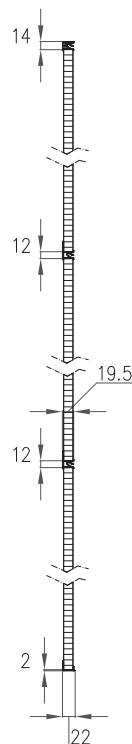
The optional accessories can be hooked into the intermediate profile or the upper end profile.

The maximum length of the profiles is 300 cm. The installed depth is 1.8 cm

For standard recess heights, the system consists of the profile set (NW PS 300) and optionally the niche rear panel set NW SET 48 or NW SET 54


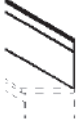




Side cover profiles will be supplied as default where necessary

If larger areas or several recess back panels are planned above each other, and appropriate number of NW ZP 300 articles must be ordered.



# Recess system

## Decor groups

		Order no. W H D	M10	M20	M30	M50	M60	M80	M90	G	N1	N2	N3
	<b>Recess back panel set for profile set</b> consists of 2 recess back panels: upper recess back panel with fixed dimension of 120 mm lower recess back panel variable for recesses 48 - 54 cm high per 10 cm	per 10 cm Width <b>NW SET48</b> <b>NEW</b>	4,70	7,70	17,50	23,30	23,30	38	9,20	-	-	-	-
		<b>minimum price</b>	47	47	47	47	47	47	47	47	-	-	-
	<b>Recess back panel set for profile set</b> consists of 2 recess back panels: upper recess back panel with fixed dimension of 120 mm lower recess back panel variable for recesses 54,5 - 60 cm high per 10 cm	per 10 cm Width <b>NW SET54</b> <b>NEW</b>	5	8,60	19,40	25,90	25,90	42	10,30	-	-	-	-
		<b>minimum price</b>	47	47	47	47	47	47	47	47	-	-	-
	<b>Recess back panel Variable versions</b> with edging finish, Max. dimensions see section 2	per m <sup>2</sup> , W x H <b>NRWMK</b>	84	143	324	432	432	695	171	-	-	-	-
		<b>minimum price</b>	47	47	47	47	47	47	47	47	-	-	-
		per 10 cm Width <b>NW PS300</b> <b>NEW</b>	12,80										
		<b>minimum price</b>	-										
	<b>optional accessories: Intermediate profile</b> Minimum length 20 cm, maximum length 300 cm per 10 cm	per 10 cm Width <b>NW ZWP300</b> <b>NEW</b>	6,40										
		<b>minimum price</b>	-										
	<b>Cover profile</b> for side covering	per 10 cm Height <b>NW AP S</b> <b>NEW</b>	6,40										
		<b>minimum price</b>	-										

**Important!**  
minimum height 7 cm  
Minimum spacings for Q and Q4 hobs:  
50 mm for induction, glass and cast iron  
200 mm for gas hobs



# Recess system Accessories

		Order no.	Price
	<b>Set of storage hooks</b> consisting of: 3 storage hooks W x H x D 13 x 51 x 20 mm	<b>NEW</b>  NW HS 3	<input type="text" value="19,20"/>
	<b>Flat shelf for recess system</b>  30 cm wide (W x H x D) 300 x 3 x 150 mm 45 cm wide (W x H x D) 450 x 3 x 150 mm 60 cm wide (W x H x D) 600 x 3 x 150 mm 90 cm wide (W x H x D) 900 x 3 x 150 mm	<b>NEW</b>  NW FA 30 NW FA 45 NW FA 60 NW FA 90	<input type="text" value="58"/> <input type="text" value="64"/> <input type="text" value="75"/> <input type="text" value="90"/>
	<b>Flat shelf with millings</b> incl. 2 acrylic containers with wooden lid 45 cm wide (W x H x D) 450 x 3 x 150 mm	<b>NEW</b>  NW AB 45	<input type="text" value="166"/>
	<b>Wine glass holder for up to 6 glasses</b> 60 cm wide (W x H x D) 600 x 3 x 150 mm	<b>NEW</b>  NW GH 60	<input type="text" value="107"/>
	<b>Holder for kitchen rolls</b> Wooden rod: oak (W x H x D) 330 x 130 x 60 mm	<b>NEW</b>  NW PRH 33	<input type="text" value="109"/>
	<b>Knife rack</b> incl. neodymium magnets with magnetic strength of 64 Newton (W x H x D) 424 x 60 x 19 mm	<b>NEW</b>  NWMEL42	<input type="text" value="130"/>
	<b>Knife block</b> for 4 knives incl. aluminium mounting profile with magnetic fixing real wood light oak (W x H x D) 250 x 120 x 64 mm	<b>NEW</b>  NW MEB 25	<input type="text" value="136"/>
	<b>Tray/cookbook bracket</b> (W x H x D) 250 x 360 x 199 mm	<b>NEW</b>  NW TH 25	<input type="text" value="94"/>
	<b>Angled shelf</b> (W x H x D) 600 x 130 x 130 mm	<b>NEW</b>  NW WA 600	<input type="text" value="138"/>

# Design suggestions FREEELEMENTS

## Ballerina by Ars Nova

FREE  
ELEMENTS



FREE ELEMENTS is space-forming system furniture for the individual kitchen and living area. Thanks to its extremely flexible frame construction of glass, metal and wood, FREE ELEMENTS creates an architectural interplay of openness, semi-transparency and coherence.

Construction principle:

Instead of using classic shelf sides in wood, FREE ELEMENTS works with side frames made of aluminium profiles.

Every carcass element is fitted with a top and a plinth base. The glass back panel is grooved on all sides.

The intermediate shelves are fixed at their height and cannot be adjusted.

The plinth area is finished with a continuous aluminium trim panel with the same finish as the side frames.

The side frames all have adjustable feet, so the height can be adjusted by up to 15 mm.

Include 10 mm on both sides and 20 mm to the ceiling as leeway for installation in the plans.

Dimensions:

Heights: 100 cm / 160 cm / 240 cm

Widths: 60 / 120 cm

Depth shelves: 50.0 cm

Depth display cabinets: 52.8 cm

Lighting:

A conductor rail is fitted to the left or middle side frame to which the individual lights for shelves are connected.

The lights are milled into the underside of the wooden shelves, and fitted into the front aluminium profile of the glass shelves.

The supply cable for the lighting (cable outlet) is connected at the bottom. The supply cables and the converter can be installed in the plinth area.

Lighting:

Each shelf can be fitted with LED lighting.

The LED light is embedded flush into the underside of the

top or intermediate shelf.

Colour temperature 2700 – 6500 K.

Energy-efficiency class: A++.

530 lumens and 5.5 W per metre. 12 V.

The supply cable for the lighting (cable outlet) is connected from the bottom in each case.

The supply cables and the converter can be fitted in the plinth area.

Note:

Available decors for wooden shelves

K075P black

K229P classic oak reproduction

K247S dark maron reproduction



# FREEELEMENTS Ballerina by Ars Nova

## Height 100 cm including plinth base

Widths: 60 / 120 cm Depth of shelf units: 50.0 cm Depth of display cabinets: 52.8 cm

Order no.

W H D

Hinge side:  
Carcass depth

### Price groups

1

	<p><b>FREE ELEMENTS design glass shelf</b>                      1 plinth base                      2 intermediate shelves, 25 mm                      1 top shelf 25 mm                      1 top cover 25 mm                      1 glass back panel                      2 glass side frames                      wide in cm: 60</p>	<p>available decors for wooden shelves:                      K075P black                      K229S classic oak reproduction                      K247S dark maron reproduction                      The item is supplied ready for assembly</p>	<p>FE GRH 60 10 50</p> <p>1662</p>
	<p><b>FREE ELEMENTS design glass shelf with LED lighting</b>                      1 plinth base                      2 intermediate shelves, 25 mm with LED lighting                      1 top shelf 25 mm                      1 top cover 25 mm                      1 glass back panel                      2 glass side frames including conductor rails                      wide in cm: 60</p>	<p>available decors for wooden shelves:                      K075P black                      K229S classic oak reproduction                      K247S dark maron reproduction                      The item is supplied ready for assembly  <b>Must be planned:</b>                      Starter set LED4-ASET60, LED-ASET60FB or LED-ASET60</p>	<p>FE GRHL 60 10 50</p> <p>2174</p>
	<p><b>FREE ELEMENTS design glass shelf with glass shelves</b>                      1 plinth base in K075P black                      2 glass shelves in an aluminium frame                      1 top shelf 25 mm in K075P black                      1 top cover 25 mm in K075P black                      1 glass back panel                      2 glass side frames                      wide in cm: 60</p>	<p>available decors for wooden shelves:                      K075P black                      The item is supplied ready for assembly</p>	<p>FE GRG 60 10 50</p> <p>1891</p>
	<p><b>FREE ELEMENTS design glass shelf with LED lighting</b>                      2 plinth bases                      4 intermediate shelves, 25 mm with LED lighting                      2 top shelves 25 mm                      1 top cover 25 mm                      1 glass back panel                      2 glass side frames including conductor rails                      wide in cm: 120</p>	<p>available decors for wooden shelves:                      K075P black                      K229S classic oak reproduction                      K247S dark maron reproduction                      The item is supplied ready for assembly  <b>Must be planned:</b>                      Starter set LED4-ASET60, LED-ASET60FB or LED-ASET60</p>	<p>FE GRHL 120 10 50</p> <p>3902</p>
	<p><b>FREE ELEMENTS design glass shelf with glass shelves</b>                      2 plinth bases in K075P black                      4 glass shelves in an aluminium frame                      2 top shelves 25 mm in K075P black                      1 top cover 25 mm in K075P black                      1 glass back panel                      2 glass side frames                      wide in cm: 120</p>	<p>available decors for wooden shelves:                      K075P black                      The item is supplied ready for assembly</p>	<p>FE GRG 120 10 50</p> <p>3336</p>
	<p><b>FREE ELEMENTS design glass shelf</b>                      2 plinth bases                      4 intermediate shelves, 25 mm                      2 top shelves 25 mm                      1 top cover 25 mm                      1 glass back panel                      2 glass side frames                      wide in cm: 120</p>	<p>available decors for wooden shelves:                      K075P black                      K229S classic oak reproduction                      K247S dark maron reproduction                      The item is supplied ready for assembly</p>	<p>FE GRH 120 10 50</p> <p>2880</p>
	<p><b>FREE ELEMENTS design display cabinet with glass door and LED lighting</b>                      1 glass door                      1 plinth base                      2 intermediate shelves, 25 mm with LED lighting                      1 top shelf 25 mm with LED lighting                      1 top cover 25 mm                      1 glass back panel                      2 glass side frames                      wide in cm: 60</p>	<p>available decors for wooden shelves:                      K075P black                      K229S classic oak reproduction                      K247S dark maron reproduction                      The item is supplied ready for assembly  <b>Must be planned:</b>                      Starter set LED4-ASET60, LED-ASET60FB or LED-ASET60</p>	<p>FE GGHL 60 10 50</p> <p>R/L 3214</p>
	<p><b>FREE ELEMENTS design display cabinet with glass door</b>                      1 glass door                      1 plinth base                      2 intermediate shelves, 25 mm                      1 top shelf 25 mm                      1 top cover 25 mm                      1 glass back panel                      2 glass side frames                      wide in cm: 60</p>	<p>available decors for wooden shelves:                      K075P black                      K229S classic oak reproduction                      K247S dark maron reproduction                      The item is supplied ready for assembly</p>	<p>FE GGH 60 10 50</p> <p>R/L 2702</p>

# FREEELEMENTS Ballerina by Ars Nova





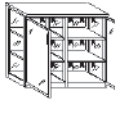



## Height 100 cm including plinth base

Widths: 60 / 120 cm Depth of shelf units: 50.0 cm Depth of display cabinets: 52.8 cm

Order no.

W H D







Hinge side:	Carcass depth:	Price groups	
		1	

 <p><b>FREE ELEMENTS design display cabinet with glass door</b>                      1 glass door                      1 plinth base in K075P black                      2 glass shelves in an aluminium frame                      1 top shelf 25 mm in K075P black                      1 top cover 25 mm in K075P black                      1 glass back panel                      2 glass side frames                      wide in cm: 60</p>	<p> available decors for wooden shelves:                      K075P black                      The item is supplied ready for assembly</p> <p><b>FE GGG 60 10 50</b> R/L <b>2936</b></p>
 <p><b>FREE ELEMENTS design display cabinet with glass door</b>                      2 glass doors                      2 plinth bases                      4 intermediate shelves, 25 mm                      2 top shelves 25 mm                      1 top cover 25 mm                      1 glass back panel                      2 glass side frames                      wide in cm: 120</p>	<p> available decors for wooden shelves:                      K075P black                      K229S classic oak reproduction                      K247S dark maron reproduction                      The item is supplied ready for assembly</p> <p><b>FE GGH 120 10 50</b> <b>4957</b></p>
 <p><b>FREE ELEMENTS design display cabinet with glass door and LED lighting</b>                      2 glass doors                      2 plinth bases                      4 intermediate shelves, 25 mm with LED lighting                      2 top shelves 25 mm with LED lighting                      1 top cover 25 mm                      1 glass back panel                      2 glass side frames                      wide in cm: 120</p>	<p> available decors for wooden shelves:                      K075P black                      K229S classic oak reproduction                      K247S dark maron reproduction                      The item is supplied ready for assembly  <b>Must be planned:</b>                      Starter set LED4-ASET60, LED-ASET60FB or LED-ASET60</p> <p><b>FE GGHL 120 10 50</b> <b>5981</b></p>
 <p><b>FREE ELEMENTS design display cabinet with glass door</b>                      2 glass doors                      2 plinth bases in K075P black                      4 glass shelves in an aluminium frame                      2 top shelves 25 mm in K075P black                      1 top cover 25 mm in K075P black                      1 glass back panel                      2 glass side frames                      wide in cm: 120</p>	<p> available decors for wooden shelves:                      K075P black                      The item is supplied ready for assembly</p> <p><b>FE GGG 120 10 50</b> <b>5427</b></p>

# FREEELEMENTS Ballerina by Ars Nova

## Height 160 cm including plinth base

Widths: 60 / 120 cm Depth of shelf units: 50.0 cm Depth of display cabinets: 52.8 cm

 <p><b>FREE ELEMENTS design glass shelf</b>                      1 plinth base                      4 intermediate shelves, 25 mm                      1 top shelf 25 mm                      1 top cover 25 mm                      1 glass back panel                      2 glass side frames                      wide in cm: 60</p>	<p> available decors for wooden shelves:                      K075P black                      K229S classic oak reproduction                      K247S dark maron reproduction                      The item is supplied ready for assembly</p> <p><b>FE GRH 60 16 50</b> <b>2093</b></p>
 <p><b>FREE ELEMENTS design glass shelf with glass shelves</b>                      1 plinth base in K075P black                      4 glass shelves in an aluminium frame                      1 top shelf 25 mm in K075P black                      1 top cover 25 mm in K075P black                      1 glass back panel                      2 glass side frames                      wide in cm: 60</p>	<p> available decors for wooden shelves:                      K075P black                      The item is supplied ready for assembly</p> <p><b>FE GRG 60 16 50</b> <b>2634</b></p>
 <p><b>FREE ELEMENTS design glass shelf with LED lighting</b>                      1 plinth base                      4 intermediate shelves, 25 mm with LED lighting                      1 top shelf 25 mm                      1 top cover 25 mm                      1 glass back panel                      2 glass side frames including conductor rails                      wide in cm: 60</p>	<p> available decors for wooden shelves:                      K075P black                      K229S classic oak reproduction                      K247S dark maron reproduction                      The item is supplied ready for assembly  <b>Must be planned:</b>                      Starter set LED4-ASET60, LED-ASET60FB or LED-ASET60</p> <p><b>FE GRHL 60 16 50</b> <b>2816</b></p>








# FREEELEMENTS Ballerina by Ars Nova

## Height 160 cm including plinth base

Widths: 60 / 120 cm Depth of shelf units: 50.0 cm Depth of display cabinets: 52.8 cm

Order no.  
W H D

Hinge side:	Carcase depth	Price groups			
		1			

 <p><b>FREE ELEMENTS design glass shelf</b> 2 plinth bases 8 intermediate shelves, 25 mm 2 top shelves 25 mm 1 top cover 25 mm 1 glass back panel 2 glass side frames wide in cm: 120</p>	<p>available decors for wooden shelves: K075P black K229S classic oak reproduction K247S dark maron reproduction The item is supplied ready for assembly</p>	<p>FE GRH 120 16 50</p> <p>3560</p>
 <p><b>FREE ELEMENTS design glass shelf with glass shelves</b> 2 plinth bases in K075P black 8 glass shelves in an aluminium frame 2 top shelves 25 mm in K075P black 1 top cover 25 mm in K075P black 1 glass back panel 2 glass side frames wide in cm: 120</p>	<p>available decors for wooden shelves: K075P black The item is supplied ready for assembly</p>	<p>FE GRG 120 16 50</p> <p>4643</p>
 <p><b>FREE ELEMENTS design glass shelf with LED lighting</b> 2 plinth bases 8 intermediate shelves, 25 mm with LED lighting 2 top shelves 25 mm 1 top cover 25 mm 1 glass back panel 2 glass side frames including conductor rails wide in cm: 120</p>	<p>available decors for wooden shelves: K075P black K229S classic oak reproduction K247S dark maron reproduction The item is supplied ready for assembly <b>Must be planned:</b> Starter set LED4-ASET60, LED-ASET60FB or LED-ASET60</p>	<p>FE GRHL 120 16 50</p> <p>5205</p>
 <p><b>FREE ELEMENTS design display cabinet with glass door</b> 1 glass door 1 plinth base 4 intermediate shelves, 25 mm 1 top shelf 25 mm 1 top cover 25 mm 1 glass back panel 2 glass side frames wide in cm: 60</p>	<p>available decors for wooden shelves: K075P black K229S classic oak reproduction K247S dark maron reproduction The item is supplied ready for assembly</p>	<p>FE GGH 60 16 50</p> <p>R/L 3053</p>
 <p><b>FREE ELEMENTS design display cabinet with glass door and LED lighting</b> 1 glass door 1 plinth base 4 intermediate shelves, 25 mm with LED lighting 1 top shelf 25 mm with LED lighting 1 top cover 25 mm 1 glass back panel 2 glass side frames wide in cm: 60</p>	<p>available decors for wooden shelves: K075P black K229S classic oak reproduction K247S dark maron reproduction The item is supplied ready for assembly <b>Must be planned:</b> Starter set LED4-ASET60, LED-ASET60FB or LED-ASET60</p>	<p>FE GGHL 60 16 50</p> <p>R/L 3875</p>
 <p><b>FREE ELEMENTS design display cabinet with glass door</b> 1 glass door 1 plinth base in K075P black 4 glass shelves in an aluminium frame 1 top shelf 25 mm in K075P black 1 top cover 25 mm in K075P black 1 glass back panel 2 glass side frames wide in cm: 60</p>	<p>available decors for wooden shelves: K075P black The item is supplied ready for assembly</p>	<p>FE GGG 60 16 50</p> <p>R/L 3443</p>
 <p><b>FREE ELEMENTS design display cabinet with glass door</b> 2 glass doors 2 plinth bases 8 intermediate shelves, 25 mm 2 top shelves 25 mm 1 top cover 25 mm 1 glass back panel 2 glass side frames wide in cm: 120</p>	<p>available decors for wooden shelves: K075P black K229S classic oak reproduction K247S dark maron reproduction The item is supplied ready for assembly</p>	<p>FE GGH 120 16 50</p> <p>5480</p>



# FREEELEMENTS Ballerina by Ars Nova

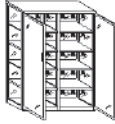



## Height 160 cm including plinth base

Widths: 60 / 120 cm Depth of shelf units: 50.0 cm Depth of display cabinets: 52.8 cm

Order no.

W H D













Hinge side: Carcass depth	Price groups									
	1									

 <p><b>FREE ELEMENTS design display cabinet with glass door and LED lighting</b>                  2 glass doors                  2 plinth bases                  8 intermediate shelves, 25 mm with LED lighting                  2 top shelves 25 mm with LED lighting                  1 top cover 25 mm                  1 glass back panel                  2 glass side frames                  wide in cm: 120</p>		<p> available decors for wooden shelves:                  K075P black                  K229S classic oak reproduction                  K247S dark maron reproduction                  The item is supplied ready for assembly  <b>Must be planned:</b>                  Starter set LED4-ASET60, LED-ASET60FB or LED-ASET60</p>	<p>FE GGHL 120 16 50</p> <p>7125</p>
 <p><b>FREE ELEMENTS design display cabinet with glass door</b>                  2 glass doors                  2 plinth bases in K075P black                  8 glass shelves in an aluminium frame                  2 top shelves 25 mm in K075P black                  1 top cover 25 mm in K075P black                  1 glass back panel                  2 glass side frames                  wide in cm: 120</p>		<p> available decors for wooden shelves:                  K075P black</p> <p>The item is supplied ready for assembly</p>	<p>FE GGG 120 16 50</p> <p>6461</p>

# FREEELEMENTS Ballerina by Ars Nova

## Height 240 cm including plinth base

Widths: 60 / 120 cm Depth of shelf units: 50.0 cm Depth of display cabinets: 52.8 cm

 <p><b>FREE ELEMENTS design glass shelf</b>                  1 plinth base                  6 intermediate shelves, 25 mm                  1 top shelf 25 mm                  1 glass back panel                  2 glass side frames                  wide in cm: 60</p>		<p> available decors for wooden shelves:                  K075P black                  K229S classic oak reproduction                  K247S dark maron reproduction                  The item is supplied ready for assembly</p>	<p>FE GRH 60 24 50</p> <p>2776</p>
 <p><b>FREE ELEMENTS design glass shelf with glass shelves</b>                  1 plinth base in K075P black                  6 glass shelves in an aluminium frame                  1 top shelf 25 mm in K075P black                  1 glass back panel                  2 glass side frames                  wide in cm: 60</p>		<p> available decors for wooden shelves:                  K075P black</p> <p>The item is supplied ready for assembly</p>	<p>FE GRG 60 24 50</p> <p>3618</p>
 <p><b>FREE ELEMENTS design glass shelf with LED lighting</b>                  1 plinth base                  6 intermediate shelves, 25 mm with LED lighting                  1 top shelf 25 mm                  1 glass back panel                  2 glass side frames including conductor rails                  wide in cm: 60</p>		<p> available decors for wooden shelves:                  K075P black                  K229S classic oak reproduction                  K247S dark maron reproduction                  The item is supplied ready for assembly  <b>Must be planned:</b>                  Starter set LED4-ASET60, LED-ASET60FB or LED-ASET60</p>	<p>FE GRHL 60 24 50</p> <p>3907</p>
 <p><b>FREE ELEMENTS design glass shelf with LED lighting</b>                  2 plinth bases                  12 intermediate shelves, 25 mm with LED lighting                  2 top shelves 25 mm                  1 glass back panel                  2 glass side frames including conductor rails                  wide in cm: 120</p>		<p> available decors for wooden shelves:                  K075P black                  K229S classic oak reproduction                  K247S dark maron reproduction                  The item is supplied ready for assembly  <b>Must be planned:</b>                  Starter set LED4-ASET60, LED-ASET60FB or LED-ASET60</p>	<p>FE GRHL 120 24 50</p> <p>6944</p>
 <p><b>FREE ELEMENTS design glass shelf</b>                  2 plinth bases                  12 intermediate shelves, 25 mm                  2 top shelves 25 mm                  1 glass back panel                  2 glass side frames                  wide in cm: 120</p>		<p> available decors for wooden shelves:                  K075P black                  K229S classic oak reproduction                  K247S dark maron reproduction                  The item is supplied ready for assembly</p>	<p>FE GRH 120 24 50</p> <p>4682</p>
 <p><b>FREE ELEMENTS design glass shelf with glass shelves</b>                  2 plinth bases in K075P black                  12 glass shelves in an aluminium frame                  2 top shelves 25 mm in K075P black                  1 glass back panel                  2 glass side frames                  wide in cm: 120</p>		<p> available decors for wooden shelves:                  K075P black</p> <p>The item is supplied ready for assembly</p>	<p>FE GRG 120 24 50</p> <p>6363</p>

# FREEELEMENTS Ballerina by Ars Nova

## Height 240 cm including plinth base

Widths: 60 / 120 cm Depth of shelf units: 50.0 cm Depth of display cabinets: 52.8 cm







Order no.

W H D

Hinge side:  
Carcass depth

### Price groups

1

 <p><b>FREE ELEMENTS design display cabinet with glass door</b>            1 glass door            1 plinth base            6 intermediate shelves, 25 mm            1 top shelf 25 mm            1 glass back panel            2 glass side frames            wide in cm: 60</p>	<p>available decors for wooden shelves:            K075P black            K229S classic oak reproduction            K247S dark maron reproduction            The item is supplied ready for assembly</p> <p><b>FE GGH 60 24 50</b> R/L <b>3944</b></p>
 <p><b>FREE ELEMENTS design display cabinet with glass door and LED lighting</b>            1 glass door            1 plinth base            6 intermediate shelves, 25 mm with LED lighting            1 top shelf 25 mm with LED lighting            1 glass back panel            2 glass side frames            wide in cm: 60</p>	<p>available decors for wooden shelves:            K075P black            K229S classic oak reproduction            K247S dark maron reproduction            The item is supplied ready for assembly  <b>Must be planned:</b>            Starter set LED4-ASET60, LED-ASET60FB or LED-ASET60</p> <p><b>FE GGHL 60 24 50</b> R/L <b>5075</b></p>
 <p><b>FREE ELEMENTS design display cabinet with glass door</b>            1 glass door            1 plinth base in K075P black            6 glass shelves in an aluminium frame            1 top shelf 25 mm in K075P black            1 glass back panel            2 glass side frames            wide in cm: 60</p>	<p>available decors for wooden shelves:            K075P black</p> <p>The item is supplied ready for assembly</p> <p><b>FE GGG 60 24 50</b> R/L <b>4784</b></p>
 <p><b>FREE ELEMENTS design display cabinet with glass door</b>            2 glass doors            2 plinth bases            12 intermediate shelves, 25 mm            2 top shelves 25 mm            1 glass back panel            2 glass side frames            wide in cm: 120</p>	<p>available decors for wooden shelves:            K075P black            K229S classic oak reproduction            K247S dark maron reproduction            The item is supplied ready for assembly</p> <p><b>FE GGH 120 24 50</b> <b>7016</b></p>
 <p><b>FREE ELEMENTS design display cabinet with glass door and LED lighting</b>            2 glass doors            2 plinth bases            12 intermediate shelves, 25 mm with LED lighting            2 top shelves 25 mm with LED lighting            1 glass back panel            2 glass side frames            wide in cm: 120</p>	<p>available decors for wooden shelves:            K075P black            K229S classic oak reproduction            K247S dark maron reproduction            The item is supplied ready for assembly  <b>Must be planned:</b>            Starter set LED4-ASET60, LED-ASET60FB or LED-ASET60</p> <p><b>FE GGHL 120 24 50</b> <b>9278</b></p>
 <p><b>FREE ELEMENTS design display cabinet with glass door</b>            2 glass doors            2 plinth bases in K075P black            12 glass shelves in an aluminium frame            2 top shelves 25 mm in K075P black            1 glass back panel            2 glass side frames            wide in cm: 120</p>	<p>available decors for wooden shelves:            K075P black</p> <p>The item is supplied ready for assembly</p> <p><b>FE GGG 120 24 50</b> <b>8698</b></p>



# 7.6

## System dressing room Dressing Room

Dressing Room system Shelf units carcase height 220.8 cm high	XL 7.6.1
Dressing Room system carcase height 220.8 cm high	XL 7.6.1-XL 7.6.4
Dressing Room system Base units 78 cm high	XL 7.6.4-XL 7.6.5
Dressing Room system Base units 84.5 cm high	XL 7.6.5
Dressing Room system Tall units carcase height 220.8 cm high	XL 7.6.5-XL 7.6.6
Dressing Room system Dresser units	XL 7.6.6
Dressing Room system Accessories	XL 7.6.7-XL 7.6.9

### Legend:



Available with grip ledge N...



Not available with grip ledge N...



This symbol indicates which models are available



This symbol indicates which models are not available



Planning advice



Merchandise net



Available carcass depths 34/45.5/55.5/61.0 cm



Available carcass depths 45.5/55.5/61.0 cm



Available carcass depths 55.5/61.0 cm






Body depth 61 cm



System dressing room  
Dressing Room




## Dressing Room system Shelf units carcase height 220.8 cm high

Carcase depth 61.0 cm

		Order no. W H D	Hinge side: Carcase depth	Decor groups									
				M10	M20	M30	M40	M50	M60	M70	M80	M90	
 <p><b>Tall shelf unit with garment rail</b></p> <p>61,0</p> <p><b>DRGRK60 22 61</b></p>				806	-	-	-	-	-	-	-	-	-
	<p>Malindi „Emotion“ LED light set for carcase interior sides in unit types with swing doors</p> <p>Unit price <b>LED-MAL 221</b></p>			91									
	<p>Preparation of the carcase side for Malindi LED light set For built-in Manila LED light, for concealed wiring Carcase interior side milled</p> <p>Unit price <b>MP-MALVKF-L</b></p> <p>prepared for the left-hand side</p> <p>Unit price <b>MP-MALVKF-R</b></p> <p>prepared for the right-hand side</p> <p>Unit price <b>MP-MALVKF-B</b></p> <p>prepared for both sides</p>			43									
				43									
 <p><b>Tall unit system element With garment rail and shelf dresser unit</b></p> <p>1 adjustable shelf</p> <p>61,0</p> <p><b>DRGRK60 22 61</b> <b>DRGRK90 22 61</b></p> <p> In the case of free-standing planning, a side panel must be taken into account. Article consists of Base and dresser unit, which means there will be joins on the side Base: Carcase depth 61 cm, carcase height 65 cm Dresser unit Carcase depth 61 cm, carcase height 156 cm</p>				891	-	-	-	-	-	-	-	-	
				1083	-	-	-	-	-	-	-	-	
	<p>Dresser lift 90 cm</p> <p><b>E-GKLF90</b></p>			107									
	<p>Malindi „Emotion“ LED light set for carcase interior sides in unit types with swing doors</p> <p>Unit price <b>LED-MAL 65</b></p>			43									
<p>Malindi „Emotion“ LED light set for carcase interior sides in unit types with swing doors</p> <p>Unit price <b>LED-MAL 156</b></p> <p>67</p> <p>Preparation of the carcase side for Malindi LED light set For built-in Manila LED light, for concealed wiring Carcase interior side milled</p> <p>Unit price <b>MP-MALVKF-L</b></p> <p>prepared for the left-hand side</p> <p>Unit price <b>MP-MALVKF-R</b></p> <p>prepared for the right-hand side</p> <p>Unit price <b>MP-MALVKF-B</b></p> <p>prepared for both sides</p>			43										
			43										
			86										
			86										

## Dressing Room system carcase height 220.8 cm high













Carcase depth 61.0 cm

		Order no. W H D	Hinge side: Carcase depth	Price groups								
				1	2	3	4	5	6	7	8	9
 <p><b>Tall shelf unit for dressing rooms With garment rail</b></p> <p>61,0</p> <p><b>DRGRK60 22 61 IA2K</b> <b>DRGRK90 22 61 IA2K</b></p> <p> <b>Not available for:</b> ALU TEC RP, ALUELEMENTS, ATLANTA-B, ATLANTA-S, BERGEN, CASTELLO, CHALET-B, CHALET-S, CHICAGO, FRAME, GENT, INTARSIA, LUGANO, LUX-B, MIAMI, NOBEL-B, NOBEL-S, OPAL-H, ORLANDO-B, ORLANDO-S, OSLO 15, PALERMO-B, PALERMO-S, ROMA-B, ROMA-S, SOFIE-B, SOFIE-S, STRIP ELEMENTS, TALEA, TESSIN 15, TIM 15, VILLAGE 15-B, VILLAGE 15-S, VINO, VIVA, YORK-B, YORK-S</p> <p> In the case of free-standing planning, a side panel must be taken into account. Article consists of Base and dresser unit Therefore, there will be joins on the side Dresser unit carcase depth 61 cm, carcase height 168.8 cm Base: Carcase depth 61 cm, carcase height 52 cm</p>				978	991	1023	1104	1215	1264	1297	1425	-
				1331	1400	1404	1478	1591	1686	1717	1886	-
	<p>Garment rail</p> <p>for carcase width 60 cm <b>E-GKLS60</b></p> <p>for carcase width 90 cm and 100 cm <b>E-GKLS100</b></p>			36								
	<p>Dresser lift 90 cm</p> <p><b>E-GKLF90</b></p>			107								
<p>Malindi „Emotion“ LED light set for carcase interior sides in unit types with swing doors</p> <p>Unit price <b>LED-MAL 169</b></p>			74									

# Dressing Room system

## carcase height 220.8 cm high







Carcase depth 61.0 cm

			Hinge side:	Carcase depth	Price groups									
Order no.					1	2	3	4	5	6	7	8	9	
W H D														
 <p><b>Preparation of the carcase side for Malindi LED light set</b> For built-in Manila LED light, for concealed wiring Carcase interior side milled</p> <p>prepared for the left-hand side</p> <p>prepared for the right-hand side</p> <p>prepared for both sides</p>														
			Unit price	<b>MP-MALVKF-L</b>	43									
			Unit price	<b>MP-MALVKF-R</b>	43									
		Unit price	<b>MP-MALVKF-B</b>	86										
 <p><b>Tall shelf unit for dressing rooms</b> <b>With garment rail</b> 3 drawers</p>	61,0		<b>DRGRK60 22 61 IS3K</b>	1014	1014	1030	1138	1245	1289	1319	1449	-		
			<b>DRGRK90 22 61 IS3K</b>	1330	1350	1361	1484	1591	1641	1684	1850	-		
			<p><b>Not available for:</b></p> <p> <b>ALU TEC RP, ALUELEMENTS, ATLANTA-B, ATLANTA-S, BERGEN, CASTELLO, CHALET-B, CHALET-S, CHICAGO, FRAME, GENT, INTARSIA, LUGANO, LUX-B, MIAMI, NOBEL-B, NOBEL-S, OPAL-H, ORLANDO-B, ORLANDO-S, OSLO 15, PALERMO-B, PALERMO-S, ROMA-B, ROMA-S, SOFIE-B, SOFIE-S, STRIP ELEMENTS, TALEA, TESSIN 15, TIM 15, VILLAGE 15-B, VILLAGE 15-S, VINO, VIVA, YORK-B, YORK-S</b></p> <p> <i>In the case of free-standing planning, a side panel must be taken into account.</i> Article consists of Base and dresser unit, which means there will be joins on the side Dresser unit carcase depth 61 cm, carcase height 168.8 cm Base: Carcase depth 61 cm, carcase height 52 cm</p>											
		<b>Dresser lift 90 cm</b>	<b>E-GKLF90</b>	107										
		<b>Malindi „Emotion“ LED light set for carcase interior sides in unit types with swing doors</b>	Unit price	<b>LED-MAL 169</b>	74									
 <p><b>Preparation of the carcase side for Malindi LED light set</b> For built-in Manila LED light, for concealed wiring Carcase interior side milled</p> <p>prepared for the left-hand side</p> <p>prepared for the right-hand side</p> <p>prepared for both sides</p>			Unit price	<b>MP-MALVKF-L</b>	43									
			Unit price	<b>MP-MALVKF-R</b>	43									
			Unit price	<b>MP-MALVKF-B</b>	86									
 <p><b>Tall shelf unit for dressing rooms</b> 3 adjustable shelves</p>	61,0		<b>DRGR 45 22 61 IA2K</b>	919	922	950	1028	1115	1188	1204	1324	-		
			<b>DRGR 60 22 61 IA2K</b>	956	969	1001	1082	1193	1242	1275	1403	-		
			<p><b>Not available for:</b></p> <p> <b>ALU TEC RP, ALUELEMENTS, ATLANTA-B, ATLANTA-S, BERGEN, CASTELLO, CHALET-B, CHALET-S, CHICAGO, FRAME, GENT, INTARSIA, LUGANO, LUX-B, MIAMI, NOBEL-B, NOBEL-S, OPAL-H, ORLANDO-B, ORLANDO-S, OSLO 15, PALERMO-B, PALERMO-S, ROMA-B, ROMA-S, SOFIE-B, SOFIE-S, STRIP ELEMENTS, TALEA, TESSIN 15, TIM 15, VILLAGE 15-B, VILLAGE 15-S, VINO, VIVA, YORK-B, YORK-S</b></p> <p> <i>In the case of free-standing planning, a side panel must be taken into account.</i> Article consists of Base: Carcase depth 61 cm, carcase height 52 cm Dresser unit carcase depth 61 cm, carcase height 168.8 cm</p>											
		<b>Malindi „Emotion“ LED light set for carcase interior sides in unit types with swing doors</b>	Unit price	<b>LED-MAL 169</b>	74									
 <p><b>Preparation of the carcase side for Malindi LED light set</b> For built-in Manila LED light, for concealed wiring Carcase interior side milled</p> <p>prepared for the left-hand side</p> <p>prepared for the right-hand side</p> <p>prepared for both sides</p>			Unit price	<b>MP-MALVKF-L</b>	43									
			Unit price	<b>MP-MALVKF-R</b>	43									
			Unit price	<b>MP-MALVKF-B</b>	86									
 <p><b>Tall shelf unit for dressing rooms</b> 3 adjustable shelves 3 drawers</p>	61,0		<b>DRGR 45 22 61 IS3K</b>	965	965	973	1070	1173	1181	1199	1319	-		
			<b>DRGR 60 22 61 IS3K</b>	992	992	1008	1116	1223	1267	1297	1427	-		
			<p><b>Not available for:</b></p> <p> <b>ALU TEC RP, ALUELEMENTS, ATLANTA-B, ATLANTA-S, BERGEN, CASTELLO, CHALET-B, CHALET-S, CHICAGO, FRAME, GENT, INTARSIA, LUGANO, LUX-B, MIAMI, NOBEL-B, NOBEL-S, OPAL-H, ORLANDO-B, ORLANDO-S, OSLO 15, PALERMO-B, PALERMO-S, ROMA-B, ROMA-S, SOFIE-B, SOFIE-S, STRIP ELEMENTS, TALEA, TESSIN 15, TIM 15, VILLAGE 15-B, VILLAGE 15-S, VINO, VIVA, YORK-B, YORK-S</b></p> <p> <i>In the case of free-standing planning, a side panel must be taken into account.</i> Article consists of Base and dresser unit, which means there will be joins on the side Base: Carcase depth 61 cm, carcase height 52 cm essay Body depth 61 cm, body height 168.8 cm</p>											
		<b>Malindi „Emotion“ LED light set for carcase interior sides in unit types with swing doors</b>	Unit price	<b>LED-MAL 169</b>	74									



# Dressing Room system carcase height 220.8 cm high


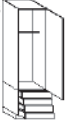

Carcase depth 61.0 cm

				Price groups										
		Order no. W H D		Hinge side:	Carcase depth	1	2	3	4	5	6	7	8	9
	<p><b>Preparation of the carcase side for Malindi LED light set</b> For built-in Manila LED light, for concealed wiring Carcase interior side milled</p> <p>prepared for the left-hand side</p> <p>prepared for the right-hand side</p> <p>prepared for both sides</p>													
2206	 <p><b>Wardrobe</b> 1 door 220.6 cm</p>		<p><b>DRGK 60 22 61 70</b></p> <p><i>Not available for:</i> ALUELEMENTS, ATLANTA-B, ATLANTA-S, BERGEN, CASTELLO, CHALET-B, CHALET-S, CHICAGO, FRAME, GARDA, LUGANO, LUX-B, MIAMI, MODENA, MUNICH, NEVADA, NOBEL-B, NOBEL-S, ORLANDO-B, ORLANDO-S, OSLO 15, PADUA, SOFIE-B, SOFIE-S, TESSIN 15, TIM 15, TREND, VINO, VIVA, YORK-B, YORK-S</p> <p><i>Each front has a tightening fitting</i> Ranges without fitting: SMARTGLAS, NOBEL, SOFIE, YORK, LUGANO, TALEA, RIVA, GARDA, ATLANTA, ORLANDO, CHICAGO without tightening fitting</p>	R/L		806	831	854	980	1071	1124	1198	1316	-
	<p><b>Malindi „Emotion“ LED light set for carcase interior sides in unit types with swing doors</b></p>													
	<p><b>Preparation of the carcase side for Malindi LED light set</b> For built-in Manila LED light, for concealed wiring Carcase interior side milled</p> <p>prepared for the left-hand side</p> <p>prepared for the right-hand side</p> <p>prepared for both sides</p>													
646 1556	 <p><b>Tall unit system element With garment rail and dresser unit</b> 1 door 64.6 cm 2 adjustable shelves 1 door 155.6 cm</p>		<p><b>DRGSK60 22 61</b></p> <p><i>In the case of free-standing planning, a side panel must be taken into account.</i> Article consists of Base and dresser unit, which means there will be joins on the side Base: Carcase depth 61 cm, carcase height 156 cm Dresser unit carcase depth 61 cm, carcase height 65 cm</p>	R/L		954	989	1087	1400	1522	1593	1732	1903	-
	<p><b>Malindi „Emotion“ LED light set for carcase interior sides in unit types with swing doors</b></p>													
	<p><b>Malindi „Emotion“ LED light set for carcase interior sides in unit types with swing doors</b></p>													
	<p><b>Preparation of the carcase side for Malindi LED light set</b> For built-in Manila LED light, for concealed wiring Carcase interior side milled</p> <p>prepared for the left-hand side</p> <p>prepared for the right-hand side</p> <p>prepared for both sides</p>													
646 1556	 <p><b>Tall unit system element With garment rail and dresser unit</b> 2 doors 64.6 cm 2 adjustable shelves 2 doors 155.6 cm</p>		<p><b>DRGSK90 22 61</b></p> <p><i>In the case of free-standing planning, a side panel must be taken into account.</i> Article consists of Base and dresser unit, which means there will be joins on the side Base: Carcase depth 61 cm, carcase height 156 cm Dresser unit carcase depth 61 cm, carcase height 65 cm</p>	R/L		1563	1621	1800	2407	2643	2767	3024	3324	-
	<p><b>Dresser lift 90 cm</b></p>													
	<p><b>Malindi „Emotion“ LED light set for carcase interior sides in unit types with swing doors</b></p>													
	<p><b>Malindi „Emotion“ LED light set for carcase interior sides in unit types with swing doors</b></p>													

# Dressing Room system




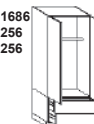


## carcase height 220.8 cm high

Carcase depth 61.0 cm

			Price groups											
			Hinge side:	Carcase depth	1	2	3	4	5	6	7	8	9	
			Order no.	W	H	D								
	<b>Preparation of the carcase side for Malindi LED light set</b> For built-in Manila LED light, for concealed wiring Carcase interior side milled  prepared for the left-hand side  prepared for the right-hand side  prepared for both sides		Unit price											
			<b>MP-MALVKF-L</b>		43									
			Unit price											
			<b>MP-MALVKF-R</b>		43									
			Unit price											
			<b>MP-MALVKF-B</b>		86									
	<b>Tall shelf unit for shoes</b> 7 metal shoe racks prepared for angled mounting	61,0	<b>DRGSHR 60 22 48</b>		734	-	-	-	-	-	-	-	-	
	<b>Metal shoe racks with raised back edge</b>		<b>MBS 60</b>		30									
	<b>Malindi „Emotion“ LED light set for carcase interior sides in unit types with swing doors</b>		Unit price											
			<b>LED-MAL 221</b>		91									
	<b>Preparation of the carcase side for Malindi LED light set</b> For built-in Manila LED light, for concealed wiring Carcase interior side milled  prepared for the left-hand side  prepared for the right-hand side  prepared for both sides		Unit price											
			<b>MP-MALVKF-L</b>		43									
			Unit price											
			<b>MP-MALVKF-R</b>		43									
			Unit price											
			<b>MP-MALVKF-B</b>		86									
	<b>Tall unit for dressing rooms With garment rail and dresser unit</b> 1 door 168.6 cm 4 drawers 12.6 cm	61,0	<b>DRGK 60 22 61 40</b>	R/L	1206	1238	1336	1668	1767	1841	1981	2177	-	
			In the case of free-standing planning, a side panel must be taken into account. Each front has a tightening fitting Ranges without fitting: SMARTGLAS, NOBEL, SOFIE, YORK, LUGANO, TALEA, RIVA, GARDA, ATLANTA, ORLANDO, CHICAGO without tightening fitting Article consists of Base and dresser unit, which means there will be joins on the side Base: Carcase depth 61 cm, carcase height 52 cm essay Body depth 61 cm, body height 168.8 cm											
	<b>Malindi „Emotion“ LED light set for carcase interior sides in unit types with swing doors</b>		Unit price											
			<b>LED-MAL 52</b>		32									
	<b>Malindi „Emotion“ LED light set for carcase interior sides in unit types with swing doors</b>		Unit price											
			<b>LED-MAL 169</b>		74									
	<b>Preparation of the carcase side for Malindi LED light set</b> For built-in Manila LED light, for concealed wiring Carcase interior side milled  prepared for the left-hand side  prepared for the right-hand side  prepared for both sides		Unit price											
			<b>MP-MALVKF-L</b>		43									
			Unit price											
			<b>MP-MALVKF-R</b>		43									
			Unit price											
			<b>MP-MALVKF-B</b>		86									
	<b>Tall unit for dressing rooms With garment rail and dresser unit</b> 2 doors 168.6 cm 4 drawers	61,0	<b>DRGK 90 22 61 40</b>		2115	2171	2398	2697	2802	2926	3181	3496	-	
			In the case of free-standing planning, a side panel must be taken into account. Each front has a tightening fitting Ranges without fitting: SMARTGLAS, NOBEL, SOFIE, YORK, LUGANO, TALEA, RIVA, GARDA, ATLANTA, ORLANDO, CHICAGO without tightening fitting Article consists of Base and dresser unit, which means there will be joins on the side Base: Carcase depth 61 cm, carcase height 52 cm essay Body depth 61 cm, body height 168.8 cm											
	<b>Dresser lift 90 cm</b>		<b>E-GKLF90</b>		107									
	<b>Malindi „Emotion“ LED light set for carcase interior sides in unit types with swing doors</b>		Unit price											
			<b>LED-MAL 52</b>		32									
	<b>Malindi „Emotion“ LED light set for carcase interior sides in unit types with swing doors</b>		Unit price											
			<b>LED-MAL 169</b>		74									

# Dressing Room system carcase height 220.8 cm high




Carcase depth 61.0 cm

				Price groups									
		Order no. W H D		Hinge side: Carcase depth	1	2	3	4	5	6	7	8	9
	<b>Preparation of the carcase side for Malindi LED light set</b> For built-in Manila LED light, for concealed wiring Carcase interior side milled												
	prepared for the left-hand side			Unit price <b>MP-MALVKF-L</b>	43								
	prepared for the right-hand side			Unit price <b>MP-MALVKF-R</b>	43								
	prepared for both sides			Unit price <b>MP-MALVKF-B</b>	86								
 1686 256 256	<b>Tall unit for dressing rooms With garment rail and dresser unit</b> 1 door 168.6 cm 2 pull-outs 25.6 cm	 61,0 61,0	<b>DRGK 60 22 61 02</b>	R/L	1187	1221	1348	1663	1742	1819	1970	2165	-
	 In the case of free-standing planning, a side panel must be taken into account. Each front has a tightening fitting Ranges without fitting: SMARTGLAS, NOBEL, SOFIE, YORK, LUGANO, TALEA, RIVA, GARDA, ATLANTA, ORLANDO, CHICAGO without tightening fitting Article consists of Base and dresser unit, which means there will be joins on the side Base: Carcase depth 61 cm, carcase height 52 cm essay Body depth 61 cm, body height 168.8 cm												
 1686 256 256	<b>Tall unit for dressing rooms With garment rail and dresser unit</b> 2 doors 168.6 cm 2 pull-outs 25.6 cm	 61,0 61,0	<b>DRGK 90 22 61 02</b>		2054	2106	2335	2635	2742	2865	3119	3428	-
	 In the case of free-standing planning, a side panel must be taken into account. Each front has a tightening fitting Ranges without fitting: SMARTGLAS, NOBEL, SOFIE, YORK, LUGANO, TALEA, RIVA, GARDA, ATLANTA, ORLANDO, CHICAGO without tightening fitting Article consists of Base and dresser unit, which means there will be joins on the side Base: Carcase depth 61 cm, carcase height 52 cm essay Body depth 61 cm, body height 168.8 cm												
	<b>Garment rail</b>												
	for carcase width 60 cm			<b>E-GKLS60</b>	36								
	for carcase width 90 cm and 100 cm			<b>E-GKLS100</b>	49								
	<b>Dresser lift 90 cm</b>			<b>E-GKLF90</b>	107								

## Dressing Room system Base units 78 cm high

Carcase depth 57.7 cm, flush with front



■ = Models also available in 34 cm and 45.5 cm carcase depth (Order no.: ... replace ... 55 ... with 34/45)

 Base shelf unit 45 cm 3 pull-outs with inset front	<b>URIF 45 78 58 IA3K</b>	■	748	762	802	890	999	1090	1128	1241	-		
	<b>URIF 60 78 58 IA3K</b>	■	785	809	853	944	1077	1144	1199	1319	-		
	<b>URIF 90 78 58 IA3K</b>	■	976	1071	1081	1183	1345	1458	1514	1665	-		
 Base shelf unit 45 cm 4 drawers with inset front	<b>URIF 45 78 58 IS4K</b>	■	739	744	754	856	974	996	1034	1137	-		
	<b>URIF 60 78 58 IS4K</b>	■	766	771	789	902	1024	1082	1132	1245	-		
	<b>URIF 90 78 58 IS4K</b>	■	903	925	939	1079	1209	1291	1349	1484	-		
 <b>Not available for:</b> ALU TEC RP, ALUELEMENTS, ATLANTA-B, ATLANTA-S, BERGEN, CASTELLO, CHALET-B, CHALET-S, CHICAGO, FRAME, GENT, INTARSIA, LUGANO, LUX-B, MIAMI, NOBEL-B, NOBEL-S, OPAL-H, ORLANDO-B, ORLANDO-S, OSLO 15, PALERMO-B, PALERMO-S, ROMA-B, ROMA-S, SOFIE-B, SOFIE-S, STRIP ELEMENTS, TALEA, TESSIN 15, TIM 15, VILLAGE 15-B, VILLAGE 15-S, VINO, VIVA, YORK-B, YORK-S													

## Dressing Room system

### Base units 84.5 cm high

■ = Models also available in 34 cm and 45.5 cm carcase depth (Order no.: ... replace ... 55 ... with 34/45)

 Base shelf unit 45 cm 3 pull-outs with inset front	<b>URIF 45 85 58 IA3K</b>	■	755	767	808	897	1004	1096	1133	1246	-
	<b>URIF 60 85 58 IA3K</b>	■	791	815	859	950	1082	1150	1204	1324	-
	<b>URIF 90 85 58 IA3K</b>	■	983	1078	1088	1189	1352	1464	1522	1674	-
 Base shelf unit 60 cm 4 drawers with inset front	<b>URIF 45 85 58 IS4K</b>	■	745	749	759	862	979	1002	1039	1143	-
	<b>URIF 90 85 58 IS4K</b>	■	909	932	946	1085	1217	1297	1357	1493	-
	<b>URIF 60 85 58 IS4K</b>	■	772	777	794	907	1029	1088	1137	1251	-



# Dressing Room system

## Base units 84.5 cm high

■ = Models also available in 34 cm and 45.5 cm carcass depth (Order no.: ... replace ... 55 ... with 34/45)

Order no.  
W H D







Hinge side:	Carcass depth	Price groups								
		1	2	3	4	5	6	7	8	9

**Not available for:**  
 ALU TEC RP, ALUELEMENTS, ATLANTA-B, ATLANTA-S, BERGEN, CASTELLO, CHALET-B, CHALET-S, CHICAGO, FRAME, GENT, INTARSIA, LUGANO, LUX-B, MIAMI, NOBEL-B, NOBEL-S, OPAL-H, ORLANDO-B, ORLANDO-S, OSLO 15, PALERMO-B, PALERMO-S, ROMA-B, ROMA-S, SOFIE-B, SOFIE-S, STRIP ELEMENTS, TALEA, TESSIN 15, TIM 15, VILLAGE 15-B, VILLAGE 15-S, VINO, VIVA, YORK-B, YORK-S

## Dressing Room system Tall units carcass height 220.8 cm high

Carcass depth 55.5 cm (standard)

■ = Models also available in 34 cm and 45.5 cm carcass depth (Order no.: ... replace ... 55 ... with 34/45) ▲ = Types also available with 61 cm carcass depth (order no. ... replace ... 55 ... with 61)

 <p><b>2206</b> Crockery cupboard 1 door 220.6 cm 1 fixed shelf 6 adjustable shelves</p>	 <p><b>1426</b> <b>126</b> <b>256</b> <b>386</b> Crockery cupboard 1 door 142.6 cm 4 adjustable shelves 1 drawer 1 pull-out 25.6 cm 1 pull-out 38.6 cm</p>	 <p><b>2206</b> Shoe cupboard 1 door 220.6 cm 7 metal shoe racks prepared for angled mounting with integrated ventilation Storage system, consisting of: 1 set of attachment rails, anthracite 1 large 3-side tray with rail, anthracite 1 carrying box for cleaning products, with profile handles, anthracite 1 hook rail with 5 hooks, anthracite</p> <p><b>Metal shoe racks with raised back edge</b></p>	<p><b>GG 30 22 55 70</b> R/L ■ 467 487 540 691 750 782 850 935 -</p> <p><b>GG 40 22 55 70</b> R/L ■ 467 487 540 691 750 782 850 935 -</p> <p><b>GG 45 22 55 70</b> R/L ■ 467 487 540 691 750 782 850 935 -</p> <p><b>GG 50 22 55 70</b> R/L ■ 467 487 540 746 796 828 897 987 -</p> <p><b>GG 60 22 55 70</b> R/L ■ 508 531 589 853 912 950 1029 1132 -</p> <p><b>Not available for:</b>        ALUELEMENTS, ATLANTA-B, ATLANTA-S, BERGEN, CASTELLO, CHALET-B, CHALET-S, CHICAGO, FRAME, GARDA, LUGANO, LUX-B, MIAMI, MODENA, MUNICH, NEVADA, NOBEL-B, NOBEL-S, ORLANDO-B, ORLANDO-S, OSLO 15, PADUA, SOFIE-B, SOFIE-S, TESSIN 15, TIM 15, TREND, VINO, VIVA, YORK-B, YORK-S</p> <p>Each front has a tightening fitting        Ranges without fitting: SMARTGLAS, NOBEL, SOFIE, YORK, LUGANO, TALEA, RIVA, GARDA, ATLANTA, ORLANDO, CHICAGO without tightening fitting</p>
 <p><b>Tall unit corner filler 90°</b> 220.8 cm high As corner connection between 2 tall units Without shelf, 9.5 x 9.5 cm</p>	 <p><b>Tall unit front filler</b> 220.8 cm high</p>	<p><b>GPW 90 22</b> 124 124 138 200 200 200 214 235 -</p> <p><b>Note:</b>        Models with horizontally running graining can only be supplied with 2-part front trim panel:        Upper dimension: 142.6 cm        Lower dimension: 77.6 cm</p>	<p><b>GP 10 22</b> 100 100 110 161 161 161 170 187 -</p> <p><b>GP 20 22</b> 110 110 120 182 182 182 200 220 -</p> <p><b>Note:</b>        Models with horizontally running graining can only be supplied with 2-part front trim panel:        Upper dimension: 142.6 cm        Lower dimension: 77.6 cm</p>
 <p><b>1426</b> <b>776</b> Laundry tall unit 1 door 142.6 cm with wide angle hinges 1 utensils container set, loose (2 x utensils containers, colour white) 1 Utensils box, loose 2 adjustable shelves 1 internal drawer 1 fixed shelf 1 pull-out with front panel 77.6 cm with frame and 2 laundry baskets (white) for dropping in (Hailo) 2-compartment sorting, 33 litres each</p>		<p><b>GWA 60 22 55 01</b> R/L ▲ 1166 1186 1247 1511 1570 1606 1688 1857 -</p> <p><b>Not available with TIP-ON</b></p>	

**Dressing Room system Tall units**  
**carcase height 220.8 cm high**  
**Carcase depth 55.5 cm (standard)**

■ = Models also available in 34 cm and 45.5 cm carcase depth (Order no.: ... replace ... 55 ... with 34/45)  
 ▲ = Types also available with 61 cm carcase depth (order no. ... replace ... 55 ... with 61)

Order no.  
 W H D

Hinge side:	Carcase depth	Price groups								
		1	2	3	4	5	6	7	8	9
R/L ▲	▲	654	673	726	878	938	969	1037	1141	-
R/L ▲	▲	654	673	726	878	938	969	1037	1141	-
R/L ▲	▲	654	673	726	933	983	1014	1083	1191	-
R/L ▲	▲	694	718	777	1040	1098	1136	1217	1339	-



**Broom cupboard**

- 1 door 220.6 cm
- 1 fixed shelf
- 1 hook rail with 5 hooks, anthracite
- Modular interior partitioning system, consisting of:
  - 1 set of attachment rails, anthracite
  - 1 large 3-side tray with rail, anthracite
  - 1 carrier box for cleaning materials with carrier rails, anthracite
  - 1 hook rail with 5 hooks, anthracite



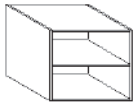
<b>GB</b>	<b>40 22 55 71</b>	R/L ▲	654	673	726	878	938	969	1037	1141	-
<b>GB</b>	<b>45 22 55 71</b>	R/L ▲	654	673	726	878	938	969	1037	1141	-
<b>GB</b>	<b>50 22 55 71</b>	R/L ▲	654	673	726	933	983	1014	1083	1191	-
<b>GB</b>	<b>60 22 55 71</b>	R/L ▲	694	718	777	1040	1098	1136	1217	1339	-

**Not available for:**  
 ALUELEMENTS, ATLANTA-B, ATLANTA-S, BERGEN, CASTELLO, CHALET-B, CHALET-S, CHICAGO, FRAME, GARDA, LUGANO, LUX-B, MIAMI, MODENA, MUNICH, NEVADA, NOBEL-B, NOBEL-S, ORLANDO-B, ORLANDO-S, OSLO 15, PADUA, SOFIE-B, SOFIE-S, TESSIN 15, TIM 15, TREND, VINO, VIVA, YORK-B, YORK-S

**Optional accessories**  
 HW HS Holder for vacuum cleaner hose or PET storage pocket (for screwing on), anthracite  
 HW UTB Utensils box, e.g. for storing towels, cleaning cloths, etc. (for screwing on), anthracite  
 Each front has a tightening fitting  
 Ranges without fitting: SMARTGLAS, NOBEL, SOFIE, YORK, LUGANO, TALEA, RIVA, GARDA, ATLANTA, ORLANDO, CHICAGO without tightening fitting

**Dressing Room system Dresser units**

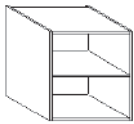
Carcase depth 57.7 cm, flush with front



**Dresser shelf unit 52 cm high**

- 1 adjustable shelf
- wide in cm: 15-30
- wide in cm: 30,1-40
- wide in cm: 40,1-45
- wide in cm: 45,1-50
- wide in cm: 50,1-60
- wide in cm: 60,1-80
- wide in cm: 80,1-90

<b>AR</b>	<b>30 52 58</b>	▲	171	-	-	-	642	-	642	642	-
<b>AR</b>	<b>40 52 58</b>	▲	171	-	-	-	642	-	642	642	-
<b>AR</b>	<b>45 52 58</b>	▲	171	-	-	-	642	-	642	642	-
<b>AR</b>	<b>50 52 58</b>	▲	171	-	-	-	642	-	642	642	-
<b>AR</b>	<b>60 52 58</b>	▲	171	-	-	-	642	-	642	642	-
<b>AR</b>	<b>80 52 58</b>	▲	214	-	-	-	803	-	803	803	-
<b>AR</b>	<b>90 52 58</b>	▲	214	-	-	-	803	-	803	803	-

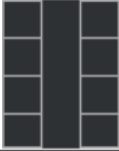

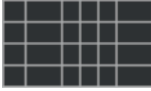


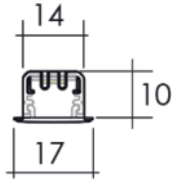
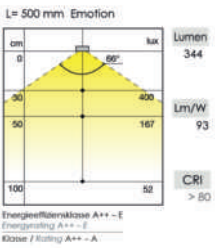


**Dresser shelf unit 65 cm high**

- 1 adjustable shelf
- wide in cm: 15-30
- wide in cm: 30,1-40
- wide in cm: 40,1-45
- wide in cm: 45,1-50
- wide in cm: 50,1-60
- wide in cm: 60,1-80
- wide in cm: 80,1-90

<b>AR</b>	<b>30 65 58</b>	▲	204	-	-	-	708	-	708	708	-
<b>AR</b>	<b>40 65 58</b>	▲	204	-	-	-	708	-	708	708	-
<b>AR</b>	<b>45 65 58</b>	▲	204	-	-	-	708	-	708	708	-
<b>AR</b>	<b>50 65 58</b>	▲	204	-	-	-	708	-	708	708	-
<b>AR</b>	<b>60 65 58</b>	▲	204	-	-	-	708	-	708	708	-
<b>AR</b>	<b>80 65 58</b>	▲	255	-	-	-	885	-	885	885	-
<b>AR</b>	<b>90 65 58</b>	▲	255	-	-	-	885	-	885	885	-







# Dressing Room system Accessories

		Order no.	Price
	<b>AMBIA-LINE dressing room set for drawers 45 cm wide</b> consisting of: 2 AMBIA-LINE frames 124 mm 1 felt mat	<b>DR SKAL 45</b>	142
	<b>AMBIA-LINE dressing room set for drawers 60 cm wide</b> consisting of: 2 AMBIA-LINE frames 100 mm 6 cross dividers for 100 mm frame 1 AMBIA-LINE frame 200 mm 3 cross dividers for 200 mm frame 1 AMBIA-LINE frame 124 mm 3 cross dividers for 124 mm frame 1 felt mat	<b>DR SKAL 60</b>	262
	<b>AMBIA-LINE dressing room set for drawers 90 cm wide</b> consisting of: 3 AMBIA-LINE frames 100 mm 9 cross dividers for 100 mm frame 2 AMBIA-LINE frames 200 mm 6 cross dividers for 200 mm frame 1 AMBIA-LINE frame 124 mm 3 cross dividers for 124 mm frame 1 felt mat	<b>DR SKAL 90</b>	398
	<b>Dresser lift 90 cm</b> for installation on the side panel, max. load 10 kg Material: Arm and garment rail: steel, Draw bar, housing, connection elements: plastic Colour/surface black, garment rail chromed Installed height min. 88 cm For carcasse width 90 cm  <i>Installation: for screwing onto the side panel                      Fastening material included in the delivery</i>	<b>E-GKLF90</b>	107
	<b>Garment rail</b> black with 2 side panel layers narrower carcasse widths for on-site adjustment	<b>NEW</b> <b>E-GKLS60</b> <b>E-GKLS100</b>	36 49
	 		
	<b>Malindi „Emotion“ LED light set for carcasse interior sides in unit types with swing doors</b> Homogeneous light, without visible light spots High-quality aluminium profile Colour: stainless steel 12 V DC <b>This product contains a light source of energy efficiency class F.</b>  <i>Emotion: infinitely variable colour temperature, from warm white (3000 K) to cold white (6000 K), including dimming function</i> <b>Must be planned:</b> Starter set and, if necessary, add-on set Must be planned: <b>Preparation of the left or right-hand carcasse side for Malindi LED light set</b> The Malindi LED light is available for: 1. unit types with side-hung doors with glass finish 2. unit types with side-hung doors with wood finish in the heights 52, 65, 78, 84.5, and 91 cm with adjustable shelves behind 3. unit types from the Dressing Room range (items DR... and URIF...) Malindi LED light is not available for: 1. corner units in all areas 2. unit types with fixed shelf 3. unit types with side-hung doors with installations behind (internal drawers, internal pull-outs, larder pull-outs, etc.) 4. modular system		
		Carcasse height 39 cm (3 W) <b>LED-MAL 39</b> 27,20 Carcasse height 52 cm (3.7 W) <b>LED-MAL 52</b> 32 Carcasse height 65 cm (5.2 W) <b>LED-MAL 65</b> 43 Carcasse height 78 cm (6.3 W) <b>LED-MAL 78</b> 48 Carcasse height 84,5 cm (6.8 W) <b>LED-MAL 85</b> 53 Carcasse height 91 cm (7.3 W) <b>LED-MAL 91</b> 53 Carcasse height 143 cm (10.8 W) <b>LED-MAL143</b> 61 Carcasse height 156 cm (11.8 W) <b>LED-MAL156</b> 67 Carcasse height 168,8 cm (12.8 W) <b>LED-MAL169</b> 74 Carcasse height 181,8 cm (13.8 W) <b>LED-MAL182</b> 77 Carcasse height 194,8 cm (14.9 W) <b>LED-MAL195</b> 85 Carcasse height 207,8 cm (15.9 W) <b>LED-MAL208</b> 90 Carcasse height 220,8 cm (16.9 W) <b>LED-MAL221</b> 91	

# Dressing Room system Accessories

		Order no.	Price
	<b>AMBIA-LINE</b>  <b>AMBIA-LINE frame for pull-out LEGRABOX</b> 270 mm long, 242 mm wide, 110 mm high	<b>Z AZAL R270</b>	61
	AMBIA-LINE Cross divider for pull-out frame 242 mm wide	<b>Z AZAL QT242</b>	14.10
	<b>AMBIA-LINE</b>  <b>AMBIA-LINE frame for pull-out LEGRABOX</b> 370 mm long, 218 mm wide, 110 mm high	<b>Z AZAL R400</b>	62
	AMBIA-LINE Cross divider for pull-out frame 218 mm wide	<b>Z AZAL QT218</b>	14.10
	<b>Solid oak designer dressing room set for drawers 45 cm wide</b> consisting of: 2x small-parts sliding element, two-piece for drawers Consisting of frame with unit, unit movable Frame without shelf, insert with shelf Dimensions: W: 164 mm H: 50 mm D: 473 mm	<b>DRSKEM 45</b>	58
	<b>Solid oak designer dressing room set for drawers 60 cm wide</b> consisting of: 5x oak wooden trays clear lacquered for drawers Small version W: 79 mm H: 50 mm D: 160 mm 5x oak wooden trays clear lacquered for drawers Large version W: 79 mm H: 50 mm D: 297 mm	<b>DRSKEM 60</b>	213
	<b>Solid oak designer dressing room set for drawers 90 cm wide</b> consisting of: 4x oak wooden trays clear lacquered for drawers Small version W: 79 mm H: 50 mm D: 160 mm 4x oak wooden trays clear lacquered for drawers Large version W: 79 mm H: 50 mm D: 297 mm 3x small-parts sliding element, two-piece for drawers Consisting of frame with unit, unit movable Frame without shelf, insert with shelf Dimensions: W: 164 mm H: 140 mm D: 473 mm	<b>DRSKEM 90</b>	258
	<b>Segment insert for pull-outs</b> Dimensions: W: 285 mm H: 140 mm D: 473 mm Without shelf Container divisions, solid oak design For 55.5 cm carcass depth / Carcass depth 61 cm Material solid oak Flat parts / shelves MDF oak veneered, thickness 3 mm, frame thickness 7 mm, upper edges straight, edges slightly chamfered, corner joints wooden dowels, surfaces, transparent dull matt lacquered 2 finger holes 100 x 18 mm below full surface glued with anti-slip mat	<b>AZSM-SE</b>	59

# Dressing Room system Accessories

		Order no.	Price	
	<b>Container for pull-outs</b> Dimensions: W: 112.5 mm H: 151.5 mm D: 450 mm	<b>AZSM-AE 11-45</b>	50	
	Dimensions: W: 225 mm H: 151.5 mm D: 450 mm	<b>AZSM-AE 22-45</b>	62	
	<b>Storage box for FREEMOBILE</b> can be planned e.g. along the entire lower level Sides solid, base veneered Dimensions: (W x H x D) 472 x 100 x 472 mm Finish: Real wood ash dark Finish: real wood light oak	REGISTERED COMMUNITY DESIGN	<b>FMOBABOX 47</b>	150
			<b>FMOBABOXE 47</b>	144
	<b>Interior dividers for FREEMOBILE storage box</b> suitable for 25 bottles solid design Dimensions: (W x H x D) 451 x 60 x 451 mm Finish: Real wood ash dark Finish: real wood light oak	REGISTERED COMMUNITY DESIGN	<b>FMOBABOX IE</b>	115
			<b>FMOBABOXE IE</b>	115
	<b>SpaceFlexx® organisation system</b> consisting of: 1 Framed 5 flexible nesttex® dividers Dimensions: (W x D x H) 520 x 472 x 130 mm		<b>Z-SPACE-F 60</b>	69
	<b>Hanging shelf</b> for shoes (W x H x D) 448 x 110 x 77 mm Finish: metal, anthracite <b>Note:</b> For mounting on the carcass side or inside of the front (possible from a door width of 60 cm)	<b>NEW</b>	<b>EHTS 60</b>	45
	<b>rail for e-shelf</b> Finish: laminate, anthracite incl. mounting and fixing material On site installation Dimensions: 1114 x 24 x 38 mm	<b>NEW</b>	<b>RB 60</b>	27.20

## Modular system

Modular system Tall units Basic carcase	XL 8.1.1
Modular system Tall units Door	XL 8.1.2-XL 8.1.3
Modular system Tall units Drawer/pull-out	XL 8.1.3-XL 8.1.5
Modular system Tall units	XL 8.1.5
Modular system Appliance unit Apertures	XL 8.1.5-XL 8.1.7
Modular system Appliance unit Apertures microwave/oven	XL 8.1.7
Modular system Appliance unit Apertures SERVO-DRIVE flex	XL 8.1.7-XL 8.1.9
Modular system Tall units Door / internal drawer / internal pull-out	XL 8.1.9-XL 8.1.14
Drawers / Pull-outs	XL 8.1.17-XL 8.1.18

### Legend:



Available with grip ledge N...



Not available with grip ledge N...



This symbol indicates which models are available



This symbol indicates which models are not available



Planning advice



Merchandise net



Not available with „push-to-open“ fitting



Aperture height specifications



Aperture height specifications



Available carcase depths 34/45.5/55.5/61.0 cm



Available carcase depths 45.5/55.5/61.0 cm



Can be used for base units



Can be used for tall units

## Modular system charged at

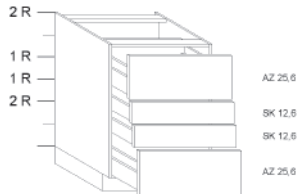
### The individual base unit!

The module unit is produced by combining a basic carcass with various equipment modules.

All base unit carcass heights are available for the module system (26 cm, 39 cm, 52 cm, 65 cm, 71.5 cm, 78 cm, 84.5 cm and 91 cm).

The module unit is available in depths of 34 cm, 45.5 cm and 55.5 cm (except module units with electrical appliances) and in widths of 30 cm, 40 cm, 45 cm, 50 cm and 60 cm.

A large selection of equipment modules are listed on the following pages.



Module unit consisting of:

**Basic carcass:**

UMX 60 78 55

**Modules**

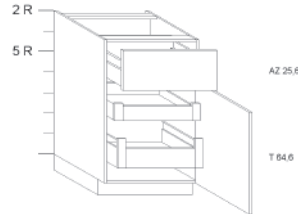
From bottom to top

X-A 60 26

X-S 60 13

X-S 60 13

X-A 60 26



Module unit consisting of:

**Basic carcass:**

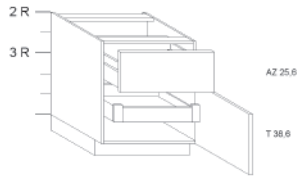
UMX 60 91 55

**Modules**

From bottom to top

X-T 60 65.IAS R

X-A 60 26



Module unit consisting of:

**Basic carcass:**

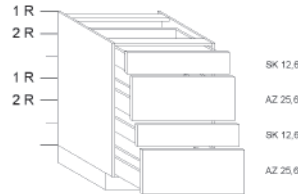
UMX 50 65 45

**Modules**

From bottom to top

X-T 50 39.IS-45

X-A 50 26-45



Module unit consisting of:

**Basic carcass:**

UMX 60 78 55

**Modules**

From bottom to top

X-A 60 26

X-S 60 13

X-A 60 26

X-S 60 13

### The individual tall unit:

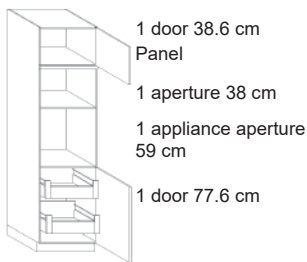
The module unit is produced by combining a basic carcass with various equipment modules.

All tall unit carcass heights are available for the module system (143 cm, 156 cm, 168.8 cm, 181.8 cm, 194.8 cm, 207.8 cm und 220.8 cm).

The module unit is available in depths of 34 cm, 45.5 cm and 55.5 cm (except module units with electrical appliances) and in widths of 30 cm, 40 cm, 45 cm, 50 cm and 60 cm.

A large selection of equipment modules can be found on the following pages.

#### Example for ordering:



Module unit consisting of:

**Basic carcass:**

GMX 60 22 55

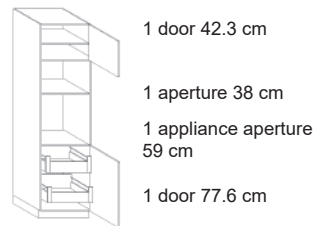
**Modules**

From bottom to top:

X-T 6078.IA2 R

X-N2B.100V

X-T 60 39 R



Module unit consisting of:

**Basic carcass:**

GMX 60 22 55

**Modules**

From bottom to top:

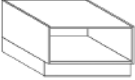

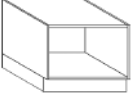
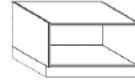
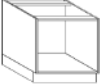
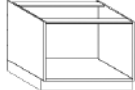

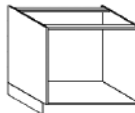

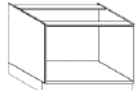
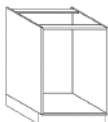
X-T 6078.IA2 R

X-N2.V height reduction to 42.3 cm

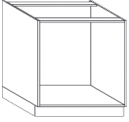
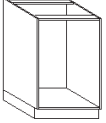
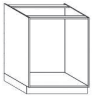
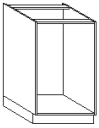
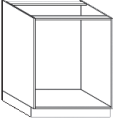
at no extra charge









# Modular system Base units Basic carcass

					Price groups	
					Hinge side:	Carcass depth
					Order no.	1
					W H D	
 <p><b>Base unit module carcass</b> With top shelf Basic carcass, 26 cm high 26 cm = 2 grids</p>	U	UMX 30 26 55	■	124		
		UMX 40 26 55	■	124		
		UMX 45 26 55	■	124		
		UMX 50 26 55	■	124		
		UMX 60 26 55	■	124		
 <p><b>Base unit module carcass</b> Basic carcass, 26 cm high 26 cm = 2 grids</p>	U	UMX 70 26 55	■	190		
		UMX 80 26 55	■	190		
		UMX 90 26 55	■	190		
		UMX 100 26 55	■	190		
		UMX 120 26 55	■	190		
 <p><b>Base unit module carcass</b> Basic carcass, 39 cm high 39 cm = 3 grids</p>	U	UMX 30 39 55	■	126		
		UMX 40 39 55	■	126		
		UMX 45 39 55	■	126		
		UMX 50 39 55	■	126		
		UMX 60 39 55	■	126		
 <p><b>Base unit module carcass</b> Basic carcass, 39 cm high 39 cm = 3 grids</p>	U	UMX 80 39 55	■	192		
		UMX 70 39 55	■	192		
		UMX 90 39 55	■	192		
		UMX 100 39 55	■	192		
		UMX 120 39 55	■	192		
 <p><b>Base unit module carcass</b> Basic carcass, 52 cm high 52 cm = 4 grids</p>	U	UMX 30 52 55	■	131		
		UMX 40 52 55	■	131		
		UMX 45 52 55	■	131		
		UMX 50 52 55	■	131		
		UMX 60 52 55	■	131		
 <p><b>Base unit module carcass</b> Basic carcass, 52 cm high 52 cm = 4 grids</p>	U	UMX 80 52 55	■	199		
		UMX 70 52 55	■	199		
		UMX 90 52 55	■	199		
		UMX 100 52 55	■	199		
		UMX 120 52 55	■	199		
 <p><b>Base unit module carcass</b> Basic carcass, 65 cm high 65 cm = 5 grids</p>	U	UMX 30 65 55	■	131		
		UMX 40 65 55	■	131		
		UMX 45 65 55	■	131		
		UMX 50 65 55	■	131		
		UMX 60 65 55	■	131		
 <p><b>Base unit module carcass</b> Basic carcass, 65 cm high 65 cm = 5 grids</p>	U	UMX 80 65 55	■	199		
		UMX 70 65 55	■	199		
		UMX 90 65 55	■	199		
		UMX 100 65 55	■	199		
		UMX 120 65 55	■	199		
 <p><b>Base unit module carcass</b> Basic carcass, 71.5 cm high 71.5 cm = 5.5 grids</p>	U	UMX 30 72 55	■	131		
		UMX 40 72 55	■	131		
		UMX 45 72 55	■	131		
		UMX 50 72 55	■	131		
		UMX 60 72 55	■	131		
 <p><b>Base unit module carcass</b> Basic carcass, 71.5 cm high 71.5 cm = 5.5 grids</p>	U	UMX 80 72 55	■	204		
		UMX 70 72 55	■	204		
		UMX 90 72 55	■	204		
		UMX 100 72 55	■	204		
		UMX 120 72 55	■	204		
 <p><b>Base unit module carcass</b> Basic carcass, 78 cm high 78 cm = 6 grids</p>	U	UMX 30 78 55	■	136		
		UMX 40 78 55	■	136		
		UMX 45 78 55	■	136		
		UMX 50 78 55	■	136		
		UMX 60 78 55	■	136		


## Modular system Base units Basic carcass

			Order no.		Hinge side:	Carcass depth	Price groups				
			W	H			D	1			
 <p><b>Base unit module carcass</b> Basic carcass, 78 cm high 78 cm = 6 grids</p>	U	UMX 80 78 55	■	204							
		UMX 70 78 55	■	204							
		UMX 90 78 55	■	204							
		UMX 100 78 55	■	204							
		UMX 120 78 55	■	204							
 <p><b>Base unit module carcass</b> Basic carcass, 84.5 cm high 84.5 cm = 6.5 grids</p>	U	UMX 30 85 55	■	140							
		UMX 40 85 55	■	140							
		UMX 45 85 55	■	140							
		UMX 50 85 55	■	140							
		UMX 60 85 55	■	140							
 <p><b>Base unit module carcass</b> Basic carcass, 84.5 cm high 84.5 cm = 6.5 grids</p>	U	UMX 80 85 55	■	209							
		UMX 70 85 55	■	209							
		UMX 90 85 55	■	209							
		UMX 100 85 55	■	209							
		UMX 120 85 55	■	209							
 <p><b>Base unit module carcass</b> Basic carcass, 91 cm high 91 cm = 7 grids</p>	U	UMX 30 91 55	■	210							
		UMX 40 91 55	■	210							
		UMX 45 91 55	■	210							
		UMX 50 91 55	■	210							
		UMX 60 91 55	■	210							
 <p><b>Base unit module carcass</b> Basic carcass, 91 cm high 91 cm = 7 grids</p>	U	UMX 80 91 55	■	316							
		UMX 70 91 55	■	316							
		UMX 90 91 55	■	316							
		UMX 100 91 55	■	316							
		UMX 120 91 55	■	316							

## Modular system Tall units Basic carcass


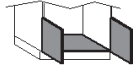

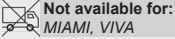
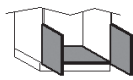
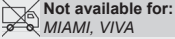





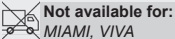
			Order no.		Hinge side:	Carcass depth	Price groups				
			W	H			D	1			
 <p><b>Appliance unit module carcass</b> Basic carcass, 143 cm high 143 cm = 11 grids</p>	G	GMX 30 14 55	■	259							
		GMX 40 14 55	■	259							
		GMX 45 14 55	■	259							
		GMX 50 14 55	■	259							
		GMX 60 14 55	■	259							
 <p><b>Appliance unit module carcass</b> Basic carcass, 156 cm high 156 cm = 12 grids</p>	G	GMX 30 15 55	■	264							
		GMX 40 15 55	■	264							
		GMX 45 15 55	■	264							
		GMX 50 15 55	■	264							
		GMX 60 15 55	■	264							
 <p><b>Appliance unit module carcass</b> Basic carcass, 168.8 cm high 168.8 cm = 13 grids</p>	G	GMX 30 16 55	■	280							
		GMX 40 16 55	■	280							
		GMX 45 16 55	■	280							
		GMX 50 16 55	■	280							
		GMX 60 16 55	■	280							
 <p><b>Appliance unit module carcass</b> Basic carcass, 181.8 cm high 181.8 cm = 14 grids</p>	G	GMX 30 18 55	■	299							
		GMX 40 18 55	■	299							
		GMX 45 18 55	■	299							
		GMX 50 18 55	■	299							
		GMX 60 18 55	■	299							
 <p><b>Appliance unit module carcass</b> Basic carcass, 194.8 cm high 194.8 cm = 15 grids</p>	G	GMX 30 19 55	■	308							
		GMX 40 19 55	■	308							
		GMX 45 19 55	■	308							
		GMX 50 19 55	■	308							
		GMX 60 19 55	■	308							
 <p><b>Appliance unit module carcass</b> Basic carcass, 207.8 cm high 207.8 cm = 16 grids</p>	G	GMX 30 20 55	■	316							
		GMX 40 20 55	■	316							
		GMX 45 20 55	■	316							
		GMX 50 20 55	■	316							
		GMX 60 20 55	■	316							

# Modular system Tall units Basic carcass

				Price groups																				
		Order no.		Hinge side:	Carcass depth	1																		
		W	H			D																		
 <p><b>Appliance unit module carcass</b> Basic carcass 220.8 cm high 220.8 cm = 17 grids</p>	<b>G</b>	<b>GMX 30 22 55</b>		■	324																			
		<b>GMX 40 22 55</b>		■	324																			
		<b>GMX 45 22 55</b>		■	324																			
		<b>GMX 50 22 55</b>		■	324																			
		<b>GMX 60 22 55</b>		■	324																			










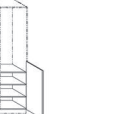

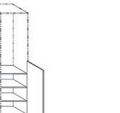

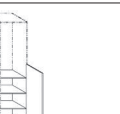

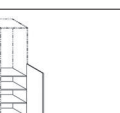

## Modular system Door

■ = Models also available in 34/45.5/61 cm carcass depth (Order no.: ... replace ... 55 ... with 34/45/61)

386	 <p><b>Door module</b> 1 door 38.6 cm 1 bottom shelf 3 grid</p>	<b>U</b>	<b>X-T 30 3955</b>	R/L	■	63	82	99	118	140	160	181	199	-	
			<b>X-T 40 3955</b>	R/L	■	63	82	99	118	140	160	181	199	-	
			<b>X-T 45 3955</b>	R/L	■	63	82	99	118	140	160	181	199	-	
			<b>G</b>	<b>X-T 50 3955</b>	R/L	■	63	82	99	118	140	160	181	199	-
				<b>X-T 60 3955</b>	R/L	■	63	82	99	118	140	160	181	199	-
386	 <p><b>Door module</b> 2 doors 38.6 cm 1 bottom shelf 3 grid</p>	<b>U</b>	<b>X-T 80 3955</b>		■	123	162	199	234	281	320	364	400	-	
			<b>X-T 90 3955</b>		■	123	162	199	234	281	320	364	400	-	
			<b>X-T 100 3955</b>		■	123	162	199	234	281	320	364	400	-	
			<b>X-T 120 3955</b>		■	123	162	199	234	281	320	364	400	-	
451	 <p><b>Door module</b> 1 door 45.1 cm 1 bottom shelf 3.5 grids</p>	<b>U</b>	<b>X-T 30 4555</b>	R/L	■	65	84	102	121	144	164	187	206	-	
			<b>X-T 40 4555</b>	R/L	■	65	84	102	121	144	164	187	206	-	
			<b>X-T 45 4555</b>	R/L	■	65	84	102	121	144	164	187	206	-	
			<b>G</b>	<b>X-T 50 4555</b>	R/L	■	65	84	102	121	144	164	187	206	-
				<b>X-T 60 4555</b>	R/L	■	65	84	102	121	144	164	187	206	-
															
451	 <p><b>Door module</b> 2 doors 45.1 cm 1 bottom shelf 3.5 grids</p>	<b>U</b>	<b>X-T 80 4555</b>		■	126	166	205	241	288	329	374	411	-	
			<b>X-T 90 4555</b>		■	126	166	205	241	288	329	374	411	-	
			<b>X-T 100 4555</b>		■	126	166	205	241	288	329	374	411	-	
			<b>X-T 120 4555</b>		■	126	166	205	241	288	329	374	411	-	
															
516	 <p><b>Door module</b> 1 door 51.6 cm 1 adjustable shelf 1 bottom shelf 4 grids</p>	<b>U</b>	<b>X-T 30 52.E55</b>	R/L	■	82	105	131	153	176	195	223	245	-	
			<b>X-T 40 52.E55</b>	R/L	■	82	105	131	153	176	195	223	245	-	
			<b>X-T 45 52.E55</b>	R/L	■	82	105	131	153	176	195	223	245	-	
			<b>G</b>	<b>X-T 50 52.E55</b>	R/L	■	82	105	131	153	176	195	223	245	-
				<b>X-T 60 52.E55</b>	R/L	■	82	105	131	153	176	195	223	245	-
516	 <p><b>Door module</b> 2 doors 51.6 cm 1 adjustable shelf 1 bottom shelf 4 grids</p>	<b>U</b>	<b>X-T 80 52.E55</b>		■	157	205	258	299	351	385	441	485	-	
			<b>X-T 90 52.E55</b>		■	157	205	258	299	351	385	441	485	-	
			<b>X-T 100 52.E55</b>		■	157	205	258	299	351	385	441	485	-	
			<b>X-T 120 52.E55</b>		■	157	205	258	299	351	385	441	485	-	
646	 <p><b>Door module</b> 1 door 64.6 cm 2 adjustable shelves 1 bottom shelf 5 grids</p>	<b>U</b>	<b>X-T 30 65.E255</b>	R/L	■	110	131	163	186	209	233	260	286	-	
			<b>X-T 40 65.E255</b>	R/L	■	110	131	163	186	209	233	260	286	-	
			<b>X-T 45 65.E255</b>	R/L	■	110	131	163	186	209	233	260	286	-	
			<b>G</b>	<b>X-T 50 65.E255</b>	R/L	■	110	131	163	186	209	233	260	286	-
				<b>X-T 60 65.E255</b>	R/L	■	110	131	163	186	209	233	260	286	-
646	 <p><b>Door module</b> 2 doors 64.6 cm 2 adjustable shelves 1 bottom shelf 5 grids</p>	<b>U</b>	<b>X-T 80 65.E255</b>		■	209	253	319	363	411	460	512	563	-	
			<b>X-T 90 65.E255</b>		■	209	253	319	363	411	460	512	563	-	
			<b>X-T 100 65.E255</b>		■	209	253	319	363	411	460	512	563	-	
			<b>X-T 120 65.E255</b>		■	209	253	319	363	411	460	512	563	-	
711	 <p><b>Door module</b> 1 door 71.1 cm 2 adjustable shelves 1 bottom shelf 5.5 grids</p>		<b>X-T 30 72.E2</b>	R/L	■	124	146	188	207	240	261	290	319	-	
			<b>X-T 40 72.E255</b>	R/L	■	124	146	188	207	240	261	290	319	-	
			<b>X-T 45 72.E255</b>	R/L	■	124	146	188	207	240	261	290	319	-	
			<b>X-T 50 72.E255</b>	R/L	■	124	146	188	207	240	261	290	319	-	
			<b>X-T 60 72.E255</b>	R/L	■	124	146	188	207	240	261	290	319	-	
															

# Modular system Door

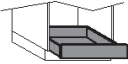


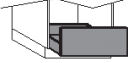





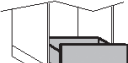








■ = Models also available in 34/45.5/61 cm carcass depth (Order no.: ... replace ... 55 ... with 34/45/61)

	Order no. W H D	Hinge side: R/L	Carcass depth	Price groups								
				1	2	3	4	5	6	7	8	9
 <p><b>Door module</b> 1 door 77.6 cm 2 adjustable shelves 1 bottom shelf 6 grids</p>	U	X-T 30 78.E255	R/L ■	124	146	188	207	240	261	290	319	-
		X-T 40 78.E255	R/L ■	124	146	188	207	240	261	290	319	-
	G	X-T 45 78.E255	R/L ■	124	146	188	207	240	261	290	319	-
		X-T 50 78.E255	R/L ■	124	146	188	207	240	261	290	319	-
		X-T 60 78.E255	R/L ■	124	146	188	207	240	261	290	319	-
 <p><b>Door module</b> 2 doors 77.6 cm 2 adjustable shelves 1 bottom shelf 6 grids</p>	U	X-T 80 78.E255	■	240	282	365	407	474	515	572	629	-
		X-T 90 78.E255	■	240	282	365	407	474	515	572	629	-
		X-T 100 78.E255	■	240	282	365	407	474	515	572	629	-
		X-T 120 78.E255	■	240	282	365	407	474	515	572	629	-
			 Not available for: MIAMI, VIVA									
 <p><b>Door module</b> 1 door 84.1 cm 2 adjustable shelves 1 bottom shelf 6.5 grids</p>	U	X-T 30 85.E255	R/L ■	128	152	193	212	248	269	299	329	-
		X-T 40 85.E255	R/L ■	128	152	193	212	248	269	299	329	-
		X-T 45 85.E255	R/L ■	128	152	193	212	248	269	299	329	-
	U	X-T 50 85.E255	R/L ■	128	152	193	212	248	269	299	329	-
		X-T 60 85.E255	R/L ■	128	152	193	212	248	269	299	329	-
		 Not available for: MIAMI, VIVA										
 <p><b>Door module</b> 2 doors 84.1 cm 2 adjustable shelves 1 bottom shelf 6.5 grids</p>	U	X-T 80 85.E255	■	248	292	375	419	489	532	588	647	-
		X-T 90 85.E255	■	248	292	375	419	489	532	588	647	-
		X-T 100 85.E255	■	248	292	375	419	489	532	588	647	-
		X-T 120 85.E255	■	248	292	375	419	489	532	588	647	-
			 Not available for: MIAMI, VIVA									
 <p><b>Door module</b> 1 door 90.6 cm 3 adjustable shelves 1 bottom shelf 7 grids</p>	U	X-T 30 91.E355	R/L ■	145	171	217	245	278	297	331	364	-
		X-T 40 91.E355	R/L ■	145	171	217	245	278	297	331	364	-
		X-T 45 91.E355	R/L ■	145	171	217	245	278	297	331	364	-
	U	X-T 50 91.E355	R/L ■	145	171	217	245	278	297	331	364	-
		X-T 60 91.E355	R/L ■	145	171	217	245	278	297	331	364	-
 <p><b>Door module</b> 2 doors 90.6 cm 3 adjustable shelves 1 bottom shelf 7 grids</p>	U	X-T 80 91.E355	■	277	331	423	478	542	581	651	716	-
		X-T 90 91.E355	■	277	331	423	478	542	581	651	716	-
		X-T 100 91.E355	■	277	331	423	478	542	581	651	716	-
		X-T 120 91.E355	■	277	331	423	478	542	581	651	716	-
 <p><b>Door module</b> 1 door 103.6 cm 3 adjustable shelves 1 bottom shelf 8 grids</p>	G	X-T 30 104.E355	R/L ■	158	183	245	267	301	326	363	399	-
		X-T 40 104.E355	R/L ■	158	183	245	267	301	326	363	399	-
		X-T 45 104.E355	R/L ■	158	183	245	267	301	326	363	399	-
		X-T 50 104.E355	R/L ■	158	183	245	267	301	326	363	399	-
		X-T 60 104.E355	R/L ■	158	183	245	267	301	326	363	399	-
			 Not available for: MIAMI, VIVA									
 <p><b>Door module</b> 1 door 116.6 cm 3 adjustable shelves 1 bottom shelf 9 grids</p>	G	X-T 30 117.E355	R/L ■	161	201	263	290	328	354	392	431	-
		X-T 40 117.E355	R/L ■	161	201	263	290	328	354	392	431	-
		X-T 45 117.E355	R/L ■	161	201	263	290	328	354	392	431	-
		X-T 50 117.E355	R/L ■	161	201	263	290	328	354	392	431	-
		X-T 60 117.E355	R/L ■	161	201	263	290	328	354	392	431	-
			 Not available for: MIAMI, VIVA									
 <p><b>Door module</b> 1 door 129.6 cm 3 adjustable shelves 1 bottom shelf 10 grids</p>	G	X-T 30 130.E355	R/L ■	171	216	286	315	354	379	419	461	-
		X-T 40 130.E355	R/L ■	171	216	286	315	354	379	419	461	-
		X-T 45 130.E355	R/L ■	171	216	286	315	354	379	419	461	-
		X-T 50 130.E355	R/L ■	171	216	286	315	354	379	419	461	-
		X-T 60 130.E355	R/L ■	171	216	286	315	354	379	419	461	-
			 Not available for: MIAMI, VIVA									
 <p><b>Door module</b> 1 door 142.6 cm 4 adjustable shelves 1 bottom shelf 11 grids</p>	G	X-T 30 143.E455	R/L ■	190	242	316	347	392	419	460	506	-
		X-T 45 143.E455	R/L ■	190	242	316	347	392	419	460	506	-
		X-T 40 143.E455	R/L ■	190	242	316	347	392	419	460	506	-
		X-T 50 143.E455	R/L ■	190	242	316	347	392	419	460	506	-
		X-T 60 143.E455	R/L ■	190	242	316	347	392	419	460	506	-
			 Not available for: MIAMI, VIVA									

# Modular system Drawer/pull-out

■ = Models also available in 34/45.5/61 cm carcass depth (Order no.: ... replace ... 55 ... with 34/45/61)  
 □ = Models also available in 45.5/61 cm carcass depth (order no.: replace ... 55 ... with 45/61)

Order no.  
 W H D













Hinge side:	Carcass depth	Price groups														
		1	2	3	4	5	6	7	8	9						
126		<b>Drawer module 13</b> 1 drawer 12.6 cm 1 grids	<b>U</b>	X-S 30 1355	■	149	154	156	161	176	190	210	231	-		
				X-S 40 1355	■	149	154	156	161	176	190	210	231	-		
				X-S 45 1355	■	149	154	156	161	176	190	210	231	-		
		<b>G</b>	X-S 50 1355	■	149	154	156	161	176	190	210	231	-			
			X-S 60 1355	■	149	154	156	161	176	190	210	231	-			
			X-S 70 1355	■	154	156	159	176	199	231	246	271	-			
			X-S 80 1355	■	154	156	159	176	199	231	246	271	-			
			X-S 90 1355	■	154	156	159	176	199	231	246	271	-			
			X-S 100 1355	■	154	156	159	176	199	231	246	271	-			
			X-S 120 1355	■	154	156	159	176	199	231	246	271	-			
			 Width 30, 40, 45, 50, 60, 80, 90, 100, 120  Width 70 Not available for: <i>ALUELEMENTS, MIAMI, STRIP ELEMENTS, VIVA</i>													
		256		<b>Drawer module 26</b> 1 drawer 25.6 cm 2 grids	<b>U</b>	X-S 30 2655	■	169	186	200	207	233	250	267	294	-
						X-S 40 2655	■	169	186	200	207	233	250	267	294	-
						X-S 45 2655	■	169	186	200	207	233	250	267	294	-
<b>G</b>	X-S 50 2655			■	169	186	200	207	233	250	267	294	-			
	X-S 60 2655			■	169	186	200	207	233	250	267	294	-			
	X-S 70 2655			■	169	192	205	227	276	292	320	352	-			
	X-S 80 2655			■	169	192	205	227	276	292	320	352	-			
	X-S 90 2655			■	169	192	205	227	276	292	320	352	-			
	X-S 100 2655			■	169	192	205	227	276	292	320	352	-			
	X-S 120 2655			■	169	192	205	227	276	292	320	352	-			
	 Width 30, 40, 45, 50, 60, 80, 90, 100, 120  Width 70 Not available for: <i>ALUELEMENTS, MIAMI, STRIP ELEMENTS, VIVA</i>															
386				<b>Drawer module 39</b> 1 drawer 38.6 cm 3 grid	<b>U</b>	X-S 30 3955	■	178	200	224	230	261	280	297	327	-
						X-S 40 3955	■	178	200	224	230	261	280	297	327	-
						X-S 45 3955	■	178	200	224	230	261	280	297	327	-
		<b>G</b>	X-S 50 3955	■	178	200	224	230	261	280	297	327	-			
			X-S 60 3955	■	178	200	224	230	261	280	297	327	-			
			X-S 70 3955	■	178	257	278	286	340	357	390	429	-			
			X-S 80 3955	■	178	257	278	286	340	357	390	429	-			
			X-S 90 3955	■	178	257	278	286	340	357	390	429	-			
			X-S 100 3955	■	178	257	278	286	340	357	390	429	-			
			X-S 120 3955	■	178	257	278	286	340	357	390	429	-			
			 Width 30, 40, 45, 50, 60, 80, 90, 100, 120  Width 70 Not available for: <i>ALUELEMENTS, MIAMI, STRIP ELEMENTS, VIVA</i>													
		256		<b>Pull-out module 26</b> 1 pull-out 25.6 cm 2 grids	<b>U</b>	X-A 30 2655	■	204	215	227	237	259	277	299	329	-
						X-A 40 2655	■	204	215	227	237	259	277	299	329	-
						X-A 45 2655	■	204	215	227	237	259	277	299	329	-
<b>G</b>	X-A 50 2655			■	204	215	227	237	259	277	299	329	-			
	X-A 60 2655			■	204	215	227	237	259	277	299	329	-			
	X-A 70 2655			■	226	252	258	286	335	353	378	416	-			
	X-A 80 2655			■	226	252	258	286	335	353	378	416	-			
	X-A 90 2655			■	226	252	258	286	335	353	378	416	-			
	X-A 100 2655			■	226	252	258	286	335	353	378	416	-			
	X-A 120 2655			□	226	252	258	286	335	353	378	416	-			
	 Width 30, 40, 45, 50, 60, 80, 90, 100, 120  Width 70 Not available for: <i>ALUELEMENTS, MIAMI, STRIP ELEMENTS, VIVA</i>															
321				<b>Pull-out module 32</b> 1 pull-out 32.1 cm 2.5 grids	<b>U</b>	X-A 30 3255	■	211	229	250	261	287	303	326	359	-
						X-A 40 3255	■	211	229	250	261	287	303	326	359	-
						X-A 45 3255	■	211	229	250	261	287	303	326	359	-
		<b>G</b>	X-A 50 3255	■	211	229	250	261	287	303	326	359	-			
			X-A 60 3255	■	211	229	250	261	287	303	326	359	-			
			X-A 70 3255	■	237	317	338	347	401	418	448	493	-			
			X-A 80 3255	■	237	317	338	347	401	418	448	493	-			
			X-A 90 3255	■	237	317	338	347	401	418	448	493	-			
			X-A 100 3255	■	237	317	338	347	401	418	448	493	-			
			X-A 120 3255	■	237	317	338	347	401	418	448	493	-			
			 Width 30, 40, 45, 50, 60, 80, 90, 100, 120 Not available for: <i>MIAMI, VIVA</i>  Width 70 Not available for: <i>ALUELEMENTS, MIAMI, STRIP ELEMENTS, VIVA</i>													
		386		<b>Pull-out module 39</b> 1 pull-out 38.6 cm 3 grid	<b>U</b>	X-A 30 3955	■	211	229	250	261	287	303	326	359	-
						X-A 40 3955	■	211	229	250	261	287	303	326	359	-
						X-A 45 3955	■	211	229	250	261	287	303	326	359	-
<b>G</b>	X-A 50 3955			■	211	229	250	261	287	303	326	359	-			
	X-A 60 3955			■	211	229	250	261	287	303	326	359	-			
	X-A 70 3955			■	237	317	338	347	401	418	448	493	-			
	X-A 80 3955			■	237	317	338	347	401	418	448	493	-			
	X-A 90 3955			■	237	317	338	347	401	418	448	493	-			
	X-A 100 3955			■	237	317	338	347	401	418	448	493	-			
	X-A 120 3955			■	237	317	338	347	401	418	448	493	-			
	 Width 30, 40, 45, 50, 60, 80, 90, 100, 120  Width 70 Not available for: <i>ALUELEMENTS, MIAMI, STRIP ELEMENTS, VIVA</i>															



# Modular system Drawer/pull-out

■ = Models also available in 34/45.5/61 cm carcass depth (Order no.: ... replace ... 55 ... with 34/45/61)  
 □ = Models also available in 45.5/61 cm carcass depth (order no.: replace ... 55 ... with 45/61)

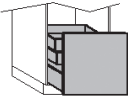

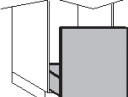
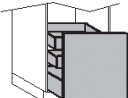
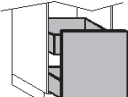


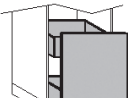

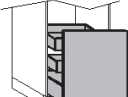

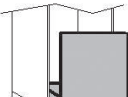


Order no.  
 W H D

Hinge side:	Carcass depth	Price groups											
		1	2	3	4	5	6	7	8	9			
U	■	X-A 30 4555	217	235	258	269	297	312	337	371	-		
		X-A 40 4555	217	235	258	269	297	312	337	371	-		
		X-A 45 4555	217	235	258	269	297	312	337	371	-		
		G	■	X-A 50 4555	217	235	258	269	297	312	337	371	-
				X-A 60 4555	217	235	258	269	297	312	337	371	-
				X-A 70 4555	245	326	348	356	413	430	463	509	-
				X-A 80 4555	245	326	348	356	413	430	463	509	-
				X-A 90 4555	245	326	348	356	413	430	463	509	-
				X-A 100 4555	245	326	348	356	413	430	463	509	-
				 Width 30, 40, 45, 50, 60, 80, 90, 100 Not available for: MIAMI, VIVA  Width 70 Not available for: ALUELEMENTS, MIAMI, STRIP ELEMENTS, VIVA									
U	■	X-A 30 5255	217	244	268	287	311	330	359	395	-		
		X-A 40 5255	217	244	268	287	311	330	359	395	-		
		X-A 45 5255	217	244	268	287	311	330	359	395	-		
		G	■	X-A 50 5255	217	244	268	287	311	330	359	395	-
				X-A 60 5255	217	244	268	287	311	330	359	395	-
				X-A 70 5255	269	326	359	371	430	441	488	537	-
				X-A 80 5255	269	326	359	371	430	441	488	537	-
				X-A 90 5255	269	326	359	371	430	441	488	537	-
				X-A 100 5255	269	326	359	371	430	441	488	537	-
				 Width 30, 40, 45, 50, 60  Width 70 Not available for: ALUELEMENTS, MIAMI, STRIP ELEMENTS, VIVA Width 80, 90, 100 Not available for: MIAMI, VIVA									
U	■	X-A 30 52.IS55	337	361	384	403	425	444	474	521	-		
		X-A 40 52.IS55	337	361	384	403	425	444	474	521	-		
		X-A 45 52.IS55	337	361	384	403	425	444	474	521	-		
		G	■	X-A 50 52.IS55	337	361	384	403	425	444	474	521	-
				X-A 60 52.IS55	337	361	384	403	425	444	474	521	-
				X-A 70 52.IS55	413	471	504	515	575	585	632	695	-
				X-A 80 52.IS55	413	471	504	515	575	585	632	695	-
				X-A 90 52.IS55	413	471	504	515	575	585	632	695	-
				X-A 100 52.IS55	413	471	504	515	575	585	632	695	-
				 Width 30, 40, 45, 50, 60, 80, 90, 100 Not available for: MIAMI, VIVA  Width 70 Not available for: ALUELEMENTS, MIAMI, STRIP ELEMENTS, VIVA									
U	■	X-A 30 52.IA55	391	423	456	470	493	518	545	600	-		
		X-A 40 52.IA55	391	423	456	470	493	518	545	600	-		
		X-A 45 52.IA55	391	423	456	470	493	518	545	600	-		
		G	■	X-A 50 52.IA55	391	423	456	470	493	518	545	600	-
				X-A 60 52.IA55	391	423	456	470	493	518	545	600	-
				X-A 70 52.IA55	498	555	587	601	658	671	717	789	-
				X-A 80 52.IA55	498	555	587	601	658	671	717	789	-
				X-A 90 52.IA55	498	555	587	601	658	671	717	789	-
				X-A 100 52.IA55	498	555	587	601	658	671	717	789	-
				 Width 30, 40, 45, 50, 60, 80, 90, 100 Not available for: MIAMI, VIVA  Width 70 Not available for: ALUELEMENTS, MIAMI, STRIP ELEMENTS, VIVA									
U	■	X-A 30 52.IS255	453	479	502	518	541	560	587	646	-		
		X-A 40 52.IS255	453	479	502	518	541	560	587	646	-		
		X-A 45 52.IS255	453	479	502	518	541	560	587	646	-		
		G	■	X-A 50 52.IS255	453	479	502	518	541	560	587	646	-
				X-A 60 52.IS255	453	479	502	518	541	560	587	646	-
				X-A 70 52.IS255	558	616	648	658	719	728	777	855	-
				X-A 80 52.IS255	558	616	648	658	719	728	777	855	-
				X-A 90 52.IS255	558	616	648	658	719	728	777	855	-
				X-A 100 52.IS255	558	616	648	658	719	728	777	855	-
				 Width 30, 40, 45, 50, 60, 80, 90, 100 Not available for: MIAMI, VIVA  Width 70 Not available for: ALUELEMENTS, MIAMI, STRIP ELEMENTS, VIVA									
U	■	X-A 30 5855	236	258	292	308	334	359	384	422	-		
		X-A 40 5855	236	258	292	308	334	359	384	422	-		
		X-A 45 5855	236	258	292	308	334	359	384	422	-		
		G	■	X-A 50 5855	236	258	292	308	334	359	384	422	-
				X-A 60 5855	236	258	292	308	334	359	384	422	-
 Width 30, 40, 45, 50, 60 Not available for: MIAMI, VIVA													
U	■	X-A 30 58.IA55	410	430	464	478	501	527	553	608	-		
		X-A 40 58.IA55	410	430	464	478	501	527	553	608	-		
		X-A 45 58.IA55	410	430	464	478	501	527	553	608	-		
		G	■	X-A 50 58.IA55	410	430	464	478	501	527	553	608	-
				X-A 60 58.IA55	410	430	464	478	501	527	553	608	-
 Width 30, 40, 45, 50, 60 Not available for: MIAMI, VIVA													

# Modular system Drawer/pull-out

■ = Models also available in 34/45.5/61 cm carcass depth (Order no.: ... replace ... 55 ... with 34/45/61)  
 □ = Models also available in 45.5/61 cm carcass depth (order no.: replace ... 55 ... with 45/61)

Order no.  
 W H D

	Hinge side:	Carcass depth	Price groups									
			1	2	3	4	5	6	7	8	9	
581  <b>Pull-out module 58</b> 1 pull-out 58.1 cm 2 internal drawers 4.5 grids	U	X-A 30 58.IS255	■	473	493	527	538	563	587	615	677	-
		X-A 40 58.IS255	■	473	493	527	538	563	587	615	677	-
		X-A 45 58.IS255	■	473	493	527	538	563	587	615	677	-
	G	X-A 50 58.IS255	■	473	493	527	538	563	587	615	677	-
		X-A 60 58.IS255	■	473	493	527	538	563	587	615	677	-
		 Width 30, 40, 45, 50, 60 Not available for: <i>MIAMI, VIVA</i>										
646  <b>Pull-out module 65</b> 1 pull-out 64.6 cm 5 grids	U	X-A 30 6555	■	236	258	292	308	334	359	384	422	-
		X-A 40 6555	■	236	258	292	308	334	359	384	422	-
		X-A 45 6555	■	236	258	292	308	334	359	384	422	-
	G	X-A 50 6555	■	236	258	292	308	334	359	384	422	-
		X-A 60 6555	■	236	258	292	308	334	359	384	422	-
646  <b>Pull-out module 65</b> 1 pull-out 64.6 cm 2 internal drawers 5 grids	U	X-A 30 65.IS255	■	473	493	527	538	563	587	615	677	-
		X-A 40 65.IS255	■	473	493	527	538	563	587	615	677	-
		X-A 45 65.IS255	■	473	493	527	538	563	587	615	677	-
	G	X-A 50 65.IS255	■	473	493	527	538	563	587	615	677	-
		X-A 60 65.IS255	■	473	493	527	538	563	587	615	677	-
646  <b>Pull-out module 65</b> 1 pull-out 64.6 cm 1 internal pull-out 5 grids	U	X-A 30 65.IA55	■	410	430	464	478	501	527	553	608	-
		X-A 40 65.IA55	■	410	430	464	478	501	527	553	608	-
		X-A 45 65.IA55	■	410	430	464	478	501	527	553	608	-
	G	X-A 50 65.IA55	■	410	430	464	478	501	527	553	608	-
		X-A 60 65.IA55	■	410	430	464	478	501	527	553	608	-
711  <b>Pull-out module 72</b> 1 pull-out 71.1 cm 5.5 grids	U	X-A 30 7255	□	255	271	314	330	359	371	399	439	-
		X-A 40 7255	□	255	271	314	330	359	371	399	439	-
		X-A 45 7255	□	255	271	314	330	359	371	399	439	-
	G	X-A 50 7255	□	255	271	314	330	359	371	399	439	-
		X-A 60 7255	□	255	271	314	330	359	371	399	439	-
		 Width 30, 40, 45, 50, 60 Not available for: <i>MIAMI, VIVA</i>										
711  <b>Pull-out module 72</b> 1 pull-out 71.1 cm 1 internal pull-out 5.5 grids	U	X-A 30 72.IA55	□	426	443	485	498	527	540	566	623	-
		X-A 40 72.IA55	□	426	443	485	498	527	540	566	623	-
		X-A 45 72.IA55	□	426	443	485	498	527	540	566	623	-
	G	X-A 50 72.IA55	□	426	443	485	498	527	540	566	623	-
		X-A 60 72.IA55	□	426	443	485	498	527	540	566	623	-
		 Width 30, 40, 45, 50, 60 Not available for: <i>MIAMI, VIVA</i>										
711  <b>Pull-out module 72</b> 1 pull-out 71.1 cm 2 internal drawers 5.5 grids	U	X-A 30 72.IS255	□	491	506	549	560	587	602	628	691	-
		X-A 40 72.IS255	□	491	506	549	560	587	602	628	691	-
		X-A 45 72.IS255	□	491	506	549	560	587	602	628	691	-
	G	X-A 50 72.IS255	□	491	506	549	560	587	602	628	691	-
		X-A 60 72.IS255	□	491	506	549	560	587	602	628	691	-
		 Width 30, 40, 45, 50, 60 Not available for: <i>MIAMI, VIVA</i>										
776  <b>Pull-out module 78</b> 1 pull-out 77.6 cm 6 grids	U	X-A 30 7855	□	255	271	314	330	359	371	399	439	-
		X-A 40 7855	□	255	271	314	330	359	371	399	439	-
		X-A 45 7855	□	255	271	314	330	359	371	399	439	-
	G	X-A 50 7855	□	255	271	314	330	359	371	399	439	-
		X-A 60 7855	□	255	271	314	330	359	371	399	439	-
776  <b>Pull-out module 78</b> 1 pull-out 77.6 cm 1 internal pull-out 6 grids	U	X-A 30 78.IA55	□	426	443	485	498	527	540	566	623	-
		X-A 40 78.IA55	□	426	443	485	498	527	540	566	623	-
		X-A 45 78.IA55	□	426	443	485	498	527	540	566	623	-
	G	X-A 50 78.IA55	□	426	443	485	498	527	540	566	623	-
		X-A 60 78.IA55	□	426	443	485	498	527	540	566	623	-
776  <b>Pull-out module 78</b> 1 pull-out 77.6 cm 2 internal drawers 6 grids	U	X-A 30 78.IS255	□	491	506	549	560	587	602	628	691	-
		X-A 40 78.IS255	□	491	506	549	560	587	602	628	691	-
		X-A 45 78.IS255	□	491	506	549	560	587	602	628	691	-
	G	X-A 50 78.IS255	□	491	506	549	560	587	602	628	691	-
		X-A 60 78.IS255	□	491	506	549	560	587	602	628	691	-



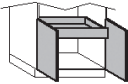
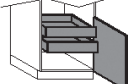
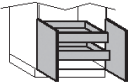
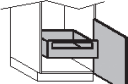
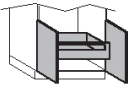




# Modular system Door / internal drawer / internal pull-out

■ = Models also available in 34/45.5/61 cm carcass depth (Order no.: ... replace ... 55 ... with 34/45/61)  
 □ = Models also available in 45.5/61 cm carcass depth (order no.: replace ... 55 ... with 45/61)

Order no.  
 W H D

Hinge side:	Carcass depth	Price groups											
		1	2	3	4	5	6	7	8	9			
U	R/L	X-T 30 39.IS55	■	191	208	227	242	264	284	306	337	-	
		X-T 40 39.IS55	■	191	208	227	242	264	284	306	337	-	
		X-T 45 39.IS55	■	191	208	227	242	264	284	306	337	-	
	G	R/L	X-T 50 39.IS55	■	191	208	227	242	264	284	306	337	-
			X-T 60 39.IS55	■	191	208	227	242	264	284	306	337	-
			Important! Doors with wide angle hinges may not be planned alongside units or panels if the protrusion to the front of the adjoining article is greater than 3 cm (hinge side). Doors with wide angle hinges protrude over the carcass side.										
U	■	X-T 80 39.IS55	■	286	325	363	399	443	483	527	580	-	
		X-T 90 39.IS55	■	286	325	363	399	443	483	527	580	-	
		X-T 100 39.IS55	■	286	325	363	399	443	483	527	580	-	
		X-T 120 39.IS55	■	286	325	363	399	443	483	527	580	-	
U	R/L	X-T 30 52.IS55	■	198	220	249	264	290	308	337	371	-	
		X-T 40 52.IS55	■	198	220	249	264	290	308	337	371	-	
		X-T 45 52.IS55	■	198	220	249	264	290	308	337	371	-	
	G	R/L	X-T 50 52.IS55	■	198	220	249	264	290	308	337	371	-
			X-T 60 52.IS55	■	198	220	249	264	290	308	337	371	-
			Planning advice: Take account of opening angle										
U	■	X-T 80 52.IS55	■	301	351	403	443	494	532	586	645	-	
		X-T 90 52.IS55	■	301	351	403	443	494	532	586	645	-	
		X-T 100 52.IS55	■	301	351	403	443	494	532	586	645	-	
		X-T 120 52.IS55	■	301	351	403	443	494	532	586	645	-	
U	R/L	X-T 30 52.IS255	■	315	339	366	378	407	423	449	494	-	
		X-T 40 52.IS255	■	315	339	366	378	407	423	449	494	-	
		X-T 45 52.IS255	■	315	339	366	378	407	423	449	494	-	
	G	R/L	X-T 50 52.IS255	■	315	339	366	378	407	423	449	494	-
			X-T 60 52.IS255	■	315	339	366	378	407	423	449	494	-
			Planning advice: Take account of opening angle										
U	■	X-T 80 52.IS255	■	444	493	547	587	640	676	731	804	-	
		X-T 90 52.IS255	■	444	493	547	587	640	676	731	804	-	
		X-T 100 52.IS255	■	444	493	547	587	640	676	731	804	-	
		X-T 120 52.IS255	■	444	493	547	587	640	676	731	804	-	
U	R/L	X-T 30 52.IA55	■	252	276	302	319	343	363	390	429	-	
		X-T 40 52.IA55	■	252	276	302	319	343	363	390	429	-	
		X-T 45 52.IA55	■	252	276	302	319	343	363	390	429	-	
	G	R/L	X-T 50 52.IA55	■	252	276	302	319	343	363	390	429	-
			X-T 60 52.IA55	■	252	276	302	319	343	363	390	429	-
			Planning advice: Take account of opening angle										
U	■	X-T 80 52.IA55	■	385	435	488	530	580	616	671	738	-	
		X-T 90 52.IA55	■	385	435	488	530	580	616	671	738	-	
		X-T 100 52.IA55	■	385	435	488	530	580	616	671	738	-	
		X-T 120 52.IA55	■	385	435	488	530	580	616	671	738	-	
U	R/L	X-T 30 58.IS55	■	198	220	249	264	290	308	337	371	-	
		X-T 40 58.IS55	■	198	220	249	264	290	308	337	371	-	
		X-T 45 58.IS55	■	198	220	249	264	290	308	337	371	-	
	G	R/L	X-T 50 58.IS55	■	198	220	249	264	290	308	337	371	-
			X-T 60 58.IS55	■	198	220	249	264	290	308	337	371	-
			Planning advice: Take account of opening angle Width 30, 40, 45, 50, 60 Not available for: MIAMI, VIVA										








# Modular system Door / internal drawer / internal pull-out

				Price groups									
				1	2	3	4	5	6	7	8	9	
■ = Models also available in 34/45.5/61 cm carcass depth (Order no.: ... replace ... 55 ... with 34/45/61) □ = Models also available in 45.5/61 cm carcass depth (order no.: replace ... 55 ... with 45/61)		Order no.											
		W H D											
		Hinge side:	Carcass depth										
581	 <p><b>Door module / internal drawer</b>                      2 doors 58.1 cm                      with wide angle hinges                      1 drawer                      4.5 grids</p> <p><b>Planning advice:</b>                      Take account of opening angle</p>	U	X-T 80 58.IS55	■	301	351	403	443	494	532	586	645	-
			X-T 90 58.IS55	■	301	351	403	443	494	532	586	645	-
			X-T 100 58.IS55	■	301	351	403	443	494	532	586	645	-
			X-T 120 58.IS55	■	301	351	403	443	494	532	586	645	-
			✂ Width 80, 90, 100, 120 Not available for: MIAMI, VIVA										
581	 <p><b>Door module / internal drawer</b>                      1 door 58.1 cm                      with wide angle hinges                      2 internal drawers                      4.5 grids</p> <p><b>Planning advice:</b>                      Take account of opening angle</p>	U	X-T 30 58.IS255	R/L ■	315	339	366	378	407	423	449	494	-
			X-T 40 58.IS255	R/L ■	315	339	366	378	407	423	449	494	-
			X-T 45 58.IS255	R/L ■	315	339	366	378	407	423	449	494	-
		G	X-T 50 58.IS255	R/L ■	315	339	366	378	407	423	449	494	-
			X-T 60 58.IS255	R/L ■	315	339	366	378	407	423	449	494	-
			✂ Width 30, 40, 45, 50, 60 Not available for: MIAMI, VIVA										
581	 <p><b>Door module / internal drawer</b>                      2 doors 58.1 cm                      with wide angle hinges                      2 internal drawers                      4.5 grids</p> <p><b>Planning advice:</b>                      Take account of opening angle</p>	U	X-T 80 58.IS255	■	444	493	547	587	640	676	731	804	-
			X-T 90 58.IS255	■	444	493	547	587	640	676	731	804	-
			X-T 100 58.IS255	■	444	493	547	587	640	676	731	804	-
			X-T 120 58.IS255	■	444	493	547	587	640	676	731	804	-
			✂ Width 80, 90, 100, 120 Not available for: MIAMI, VIVA										
581	 <p><b>Door module / internal pull-out</b>                      1 door 58.1 cm                      with wide angle hinges                      1 internal pull-out                      4.5 grids</p> <p><b>Planning advice:</b>                      Take account of opening angle</p>	U	X-T 30 58.IA55	R/L ■	252	276	302	319	343	363	390	429	-
			X-T 40 58.IA55	R/L ■	252	276	302	319	343	363	390	429	-
			X-T 45 58.IA55	R/L ■	252	276	302	319	343	363	390	429	-
		G	X-T 50 58.IA55	R/L ■	252	276	302	319	343	363	390	429	-
			X-T 60 58.IA55	R/L ■	252	276	302	319	343	363	390	429	-
			✂ Width 30, 40, 45, 50, 60 Not available for: MIAMI, VIVA										
581	 <p><b>Door module / internal pull-out</b>                      2 doors 58.1 cm                      with wide angle hinges                      1 internal pull-out                      4.5 grids</p> <p><b>Planning advice:</b>                      Take account of opening angle</p>	U	X-T 80 58.IA55	■	385	435	488	530	580	616	671	738	-
			X-T 90 58.IA55	■	385	435	488	530	580	616	671	738	-
			X-T 100 58.IA55	■	385	435	488	530	580	616	671	738	-
			X-T 120 58.IA55	■	385	435	488	530	580	616	671	738	-
			✂ Width 80, 90, 100, 120 Not available for: MIAMI, VIVA										
646	 <p><b>Door module / internal drawer</b>                      1 door 64.6 cm                      with wide angle hinges                      3 internal drawers                      5 grids</p> <p><b>Planning advice:</b>                      Take account of opening angle</p>	U	X-T 30 65.IS355	R/L ■	448	473	504	518	542	566	594	653	-
			X-T 40 65.IS355	R/L ■	448	473	504	518	542	566	594	653	-
			X-T 45 65.IS355	R/L ■	448	473	504	518	542	566	594	653	-
		G	X-T 50 65.IS355	R/L ■	448	473	504	518	542	566	594	653	-
			X-T 60 65.IS355	R/L ■	448	473	504	518	542	566	594	653	-
646	 <p><b>Door module / internal drawer</b>                      2 doors 64.6 cm                      with wide angle hinges                      3 internal drawers                      5 grids</p> <p><b>Planning advice:</b>                      Take account of opening angle</p>	U	X-T 80 65.IS355	■	625	668	735	778	827	873	928	1021	-
			X-T 90 65.IS355	■	625	668	735	778	827	873	928	1021	-
			X-T 100 65.IS355	■	625	668	735	778	827	873	928	1021	-
			X-T 120 65.IS355	■	625	668	735	778	827	873	928	1021	-
646	 <p><b>Door module / internal pull-out</b>                      1 door 64.6 cm                      with wide angle hinges                      1 internal pull-out                      1 internal drawer                      5 grids</p> <p><b>Planning advice:</b>                      Take account of opening angle</p>	U	X-T 30 65.IAS55	R/L ■	385	410	441	456	481	504	532	585	-
			X-T 40 65.IAS55	R/L ■	385	410	441	456	481	504	532	585	-
			X-T 45 65.IAS55	R/L ■	385	410	441	456	481	504	532	585	-
		G	X-T 50 65.IAS55	R/L ■	385	410	441	456	481	504	532	585	-
			X-T 60 65.IAS55	R/L ■	385	410	441	456	481	504	532	585	-
646	 <p><b>Door module / internal pull-out</b>                      2 doors 64.6 cm                      with wide angle hinges                      1 internal pull-out                      1 internal drawer                      5 grids</p> <p><b>Planning advice:</b>                      Take account of opening angle</p>	U	X-T 80 65.IAS55	□	554	597	660	703	749	797	850	935	-
			X-T 90 65.IAS55	■	554	597	660	703	749	797	850	935	-
			X-T 100 65.IAS55	■	554	597	660	703	749	797	850	935	-
			X-T 120 65.IAS55	■	554	597	660	703	749	797	850	935	-

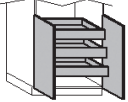
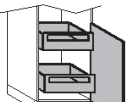
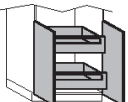


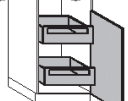
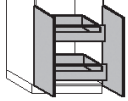
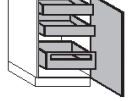
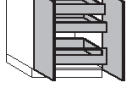
# Modular system Door / internal drawer / internal pull-out

■ = Models also available in 34/45/61 cm carcass depth (Order no.: ... replace ... 55 ... with 34/45/61)  
 □ = Models also available in 45.5/61 cm carcass depth (order no.: replace ... 55 ... with 45/61)

Order no.  
W H D

Hinge side:	Carcass depth	Price groups											
		1	2	3	4	5	6	7	8	9			
U	R/L	X-T 30 72.IS355	■	466	487	528	540	573	595	623	685	-	
		X-T 40 72.IS355	■	466	487	528	540	573	595	623	685	-	
		X-T 45 72.IS355	■	466	487	528	540	573	595	623	685	-	
	G	R/L	X-T 50 72.IS355	■	466	487	528	540	573	595	623	685	-
		R/L	X-T 60 72.IS355	■	466	487	528	540	573	595	623	685	-
 Width 30, 40, 45, 50, 60 Not available for: MIAMI, VIVA													
U	R/L	X-T 80 72.IS355	■	656	699	781	823	890	930	988	1087	-	
		X-T 90 72.IS355	■	656	699	781	823	890	930	988	1087	-	
		X-T 100 72.IS355	■	656	699	781	823	890	930	988	1087	-	
	G	R/L	X-T 120 72.IS355	■	656	699	781	823	890	930	988	1087	-
		 Width 80, 90, 100, 120 Not available for: MIAMI, VIVA											
U	R/L	X-T 30 72.IA255	■	458	479	519	532	565	585	615	677	-	
		X-T 40 72.IA255	■	458	479	519	532	565	585	615	677	-	
		X-T 45 72.IA255	■	458	479	519	532	565	585	615	677	-	
	G	R/L	X-T 50 72.IA255	■	458	479	519	532	565	585	615	677	-
		R/L	X-T 60 72.IA255	■	458	479	519	532	565	585	615	677	-
 Width 30, 40, 45, 50, 60 Not available for: MIAMI, VIVA													
U	R/L	X-T 80 72.IA255	■	684	723	806	848	915	956	1014	1115	-	
		X-T 90 72.IA255	■	684	723	806	848	915	956	1014	1115	-	
		X-T 100 72.IA255	■	684	723	806	848	915	956	1014	1115	-	
	G	R/L	X-T 120 72.IA255	■	684	723	806	848	915	956	1014	1115	-
		 Width 80, 90, 100, 120 Not available for: MIAMI, VIVA											
U	R/L	X-T 30 78.IS355	■	466	487	528	540	573	595	623	685	-	
		X-T 40 78.IS355	■	466	487	528	540	573	595	623	685	-	
		X-T 45 78.IS355	■	466	487	528	540	573	595	623	685	-	
	G	R/L	X-T 50 78.IS355	■	466	487	528	540	573	595	623	685	-
		R/L	X-T 60 78.IS355	■	466	487	528	540	573	595	623	685	-
U	R/L	X-T 80 78.IS355	■	643	684	764	803	869	909	968	1065	-	
		X-T 90 78.IS355	■	643	684	764	803	869	909	968	1065	-	
		X-T 100 78.IS355	■	643	684	764	803	869	909	968	1065	-	
	G	R/L	X-T 120 78.IS355	■	643	684	764	803	869	909	968	1065	-
		 Width 80, 90, 100, 120 Not available for: MIAMI, VIVA											
U	R/L	X-T 30 78.IA255	■	458	479	519	532	565	585	615	677	-	
		X-T 40 78.IA255	■	458	479	519	532	565	585	615	677	-	
		X-T 45 78.IA255	■	458	479	519	532	565	585	615	677	-	
	G	R/L	X-T 50 78.IA255	■	458	479	519	532	565	585	615	677	-
		R/L	X-T 60 78.IA255	■	458	479	519	532	565	585	615	677	-
U	R/L	X-T 80 78.IA255	■	684	723	806	848	915	956	1014	1115	-	
		X-T 90 78.IA255	■	684	723	806	848	915	956	1014	1115	-	
		X-T 100 78.IA255	■	684	723	806	848	915	956	1014	1115	-	
	G	R/L	X-T 120 78.IA255	■	684	723	806	848	915	956	1014	1115	-
		 Width 80, 90, 100, 120 Not available for: MIAMI, VIVA											
U	R/L	X-T 30 85.IS355	■	480	501	545	555	589	613	642	706	-	
		X-T 40 85.IS355	■	480	501	545	555	589	613	642	706	-	
		X-T 45 85.IS355	■	480	501	545	555	589	613	642	706	-	
	G	R/L	X-T 50 85.IS355	■	480	501	545	555	589	613	642	706	-
		R/L	X-T 60 85.IS355	■	480	501	545	555	589	613	642	706	-
 Width 30, 40, 45, 50, 60 Not available for: MIAMI, VIVA													

# Modular system Door / internal drawer / internal pull-out















				Price groups										
				1	2	3	4	5	6	7	8	9		
■ = Models also available in 34/45.5/61 cm carcass depth (Order no.: ... replace ... 55 ... with 34/45/61) □ = Models also available in 45.5/61 cm carcass depth (order no.: replace ... 55 ... with 45/61)		Order no.												
		W H D												
		Hinge side:	Carcass depth:											
841	 <p><b>Door module / internal drawer</b>                      2 doors 84.1 cm                      with wide angle hinges                      3 internal drawers                      6.5 grids</p> <p><b>Planning advice:</b>                      Take account of opening angle</p>	<b>U</b>	X-T 80 85.IS355	■	663	703	787	828	896	936	996	1096	-	
			X-T 90 85.IS355	■	663	703	787	828	896	936	996	1096	-	
			X-T 100 85.IS355	■	663	703	787	828	896	936	996	1096	-	
			✗ Width 80, 90, 100 Not available for: MIAMI, VIVA											
841	 <p><b>Door module / internal pull-out</b>                      1 door 84.1 cm                      with wide angle hinges                      2 internal pull-outs                      6.5 grids</p> <p><b>Planning advice:</b>                      Take account of opening angle</p>	<b>U</b>	X-T 30 85.IA255	R/L	■	472	493	536	548	582	604	632	695	-
			X-T 40 85.IA255	R/L	■	472	493	536	548	582	604	632	695	-
			X-T 45 85.IA255	R/L	■	472	493	536	548	582	604	632	695	-
			X-T 50 85.IA255	R/L	■	472	493	536	548	582	604	632	695	-
			X-T 60 85.IA255	R/L	■	472	493	536	548	582	604	632	695	-
			✗ Width 30, 40, 45, 50, 60 Not available for: MIAMI, VIVA											
841	 <p><b>Door module / internal pull-out</b>                      2 doors 84.1 cm                      with wide angle hinges                      2 internal pull-outs                      6.5 grids</p> <p><b>Planning advice:</b>                      Take account of opening angle</p>	<b>U</b>	X-T 80 85.IA255	■	703	745	830	873	941	985	1045	1150	-	
			X-T 90 85.IA255	■	703	745	830	873	941	985	1045	1150	-	
			X-T 100 85.IA255	■	703	745	830	873	941	985	1045	1150	-	
			✗ Width 80, 90, 100 Not available for: MIAMI, VIVA											
906	 <p><b>Door module / internal drawer</b>                      1 door 90.6 cm                      with wide angle hinges                      3 internal drawers                      7 grids</p> <p><b>Planning advice:</b>                      Take account of opening angle</p>	<b>U</b>	X-T 30 91.IS355	R/L	■	480	506	553	571	604	623	657	723	-
			X-T 40 91.IS355	R/L	■	480	506	553	571	604	623	657	723	-
			X-T 45 91.IS355	R/L	■	480	506	553	571	604	623	657	723	-
			X-T 50 91.IS355	R/L	■	480	506	553	571	604	623	657	723	-
			X-T 60 91.IS355	R/L	■	480	506	553	571	604	623	657	723	-
906	 <p><b>Door module / internal drawer</b>                      2 doors 90.6 cm                      with wide angle hinges                      3 internal drawers                      7 grids</p> <p><b>Planning advice:</b>                      Take account of opening angle</p>	<b>U</b>	X-T 80 91.IS355	■	685	739	831	885	950	988	1059	1165	-	
			X-T 90 91.IS355	■	685	739	831	885	950	988	1059	1165	-	
			X-T 100 91.IS355	■	685	739	831	885	950	988	1059	1165	-	
			X-T 120 91.IS355	■	685	739	831	885	950	988	1059	1165	-	
906	 <p><b>Door module / internal pull-out</b>                      1 door 90.6 cm                      with wide angle hinges                      2 internal pull-outs                      7 grids</p> <p><b>Planning advice:</b>                      Take account of opening angle</p>	<b>U</b>	X-T 30 91.IA255	R/L	■	472	498	545	562	596	615	650	715	-
			X-T 40 91.IA255	R/L	■	472	498	545	562	596	615	650	715	-
			X-T 45 91.IA255	R/L	■	472	498	545	562	596	615	650	715	-
			X-T 50 91.IA255	R/L	■	472	498	545	562	596	615	650	715	-
			X-T 60 91.IA255	R/L	■	472	498	545	562	596	615	650	715	-
906	 <p><b>Door module / internal pull-out</b>                      2 doors 90.6 cm                      with wide angle hinges                      2 internal pull-outs                      7 grids</p> <p><b>Planning advice:</b>                      Take account of opening angle</p>	<b>U</b>	X-T 80 91.IA255	■	709	765	856	909	975	1014	1084	1192	-	
			X-T 90 91.IA255	■	709	765	856	909	975	1014	1084	1192	-	
			X-T 100 91.IA255	■	709	765	856	909	975	1014	1084	1192	-	
			X-T 120 91.IA255	■	709	765	856	909	975	1014	1084	1192	-	
906	 <p><b>Door module / internal pull-out</b>                      1 door 90.6 cm                      with wide angle hinges                      2 internal drawers                      1 internal pull-out                      7 grids</p> <p><b>Planning advice:</b>                      Take account of opening angle</p>	<b>U</b>	X-T 30 91.IAS255	R/L	■	534	561	607	624	656	677	711	782	-
			X-T 40 91.IAS255	R/L	■	534	561	607	624	656	677	711	782	-
			X-T 45 91.IAS255	R/L	■	534	561	607	624	656	677	711	782	-
			X-T 50 91.IAS255	R/L	■	534	561	607	624	656	677	711	782	-
			X-T 60 91.IAS255	R/L	■	534	561	607	624	656	677	711	782	-
906	 <p><b>Door module / internal pull-out</b>                      2 doors 90.6 cm                      with wide angle hinges                      2 internal drawers                      1 internal pull-out                      7 grids</p> <p><b>Planning advice:</b>                      Take account of opening angle</p>	<b>U</b>	X-T 80 91.IAS255	■	769	825	916	970	1035	1073	1143	1257	-	
			X-T 90 91.IAS255	■	769	825	916	970	1035	1073	1143	1257	-	
			X-T 100 91.IAS255	■	769	825	916	970	1035	1073	1143	1257	-	
			X-T 120 91.IAS255	■	769	825	916	970	1035	1073	1143	1257	-	



# Modular system Door / internal drawer / internal pull-out

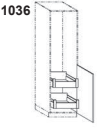
■ = Models also available in 34/45/61 cm carcass depth (Order no.: ... replace ... 55 ... with 34/45/61)  
 □ = Models also available in 45.5/61 cm carcass depth (order no.: replace ... 55 ... with 45/61)

Order no.  
W H D

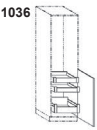
Hinge side:	Carcass depth	Price groups									
		1	2	3	4	5	6	7	8	9	
R/L ■	104.IS355	X-T 30	492	518	579	594	628	653	689	758	-
		X-T 40	492	518	579	594	628	653	689	758	-
		X-T 45	492	518	579	594	628	653	689	758	-
		X-T 50	492	518	579	594	628	653	689	758	-
		X-T 60	492	518	579	594	628	653	689	758	-
 Width 30, 40, 45, 50 Not available for: MIAMI, VIVA  Width 60											
R/L ▲	104.IA255	X-T 30	483	508	570	584	620	646	681	749	-
		X-T 40	483	508	570	584	620	646	681	749	-
		X-T 45	483	508	570	584	620	646	681	749	-
		X-T 50	483	508	570	584	620	646	681	749	-
		X-T 60	483	508	570	584	620	646	681	749	-
 Width 30, 40, 45, 50 Not available for: MIAMI, VIVA  Width 60											
R/L ▲	104.IAS255	X-T 30	547	572	633	647	682	707	742	816	-
		X-T 40	547	572	633	647	682	707	742	816	-
		X-T 45	547	572	633	647	682	707	742	816	-
		X-T 50	547	572	633	647	682	707	742	816	-
		X-T 60	547	572	633	647	682	707	742	816	-
 Width 30, 40, 45, 50 Not available for: MIAMI, VIVA  Width 60											
R/L ▲	104.IA2S55	X-T 30	602	626	688	700	735	761	794	873	-
		X-T 40	602	626	688	700	735	761	794	873	-
		X-T 45	602	626	688	700	735	761	794	873	-
		X-T 50	602	626	688	700	735	761	794	873	-
		X-T 60	602	626	688	700	735	761	794	873	-
 Width 30, 40, 45, 50 Not available for: MIAMI, VIVA  Width 60											
R/L ▲	104.IA2S25	X-T 30	719	744	806	814	850	873	909	1000	-
		X-T 40	719	744	806	814	850	873	909	1000	-
		X-T 45	719	744	806	814	850	873	909	1000	-
		X-T 50	719	744	806	814	850	873	909	1000	-
		X-T 60	719	744	806	814	850	873	909	1000	-
 Width 30, 40, 45, 50 Not available for: MIAMI, VIVA  Width 60											
R/L ■	117.IS355	X-T 30	495	535	599	617	654	681	719	791	-
		X-T 40	495	535	599	617	654	681	719	791	-
		X-T 45	495	535	599	617	654	681	719	791	-
		X-T 50	495	535	599	617	654	681	719	791	-
		X-T 60	495	535	599	617	654	681	719	791	-
 Width 30, 40, 45, 50, 60 Not available for: MIAMI, VIVA											
R/L ▲	117.IA255	X-T 30	487	527	588	608	647	671	710	781	-
		X-T 40	487	527	588	608	647	671	710	781	-
		X-T 45	487	527	588	608	647	671	710	781	-
		X-T 50	487	527	588	608	647	671	710	781	-
		X-T 60	487	527	588	608	647	671	710	781	-
 Width 30, 40, 45, 50, 60 Not available for: MIAMI, VIVA											
R/L ▲	117.IAS255	X-T 30	550	588	653	669	708	734	772	849	-
		X-T 40	550	588	653	669	708	734	772	849	-
		X-T 45	550	588	653	669	708	734	772	849	-
		X-T 50	550	588	653	669	708	734	772	849	-
		X-T 60	550	588	653	669	708	734	772	849	-
 Width 30, 40, 45, 50, 60 Not available for: MIAMI, VIVA											
R/L ▲	117.IA2S55	X-T 30	605	644	708	723	762	787	826	909	-
		X-T 40	605	644	708	723	762	787	826	909	-
		X-T 45	605	644	708	723	762	787	826	909	-
		X-T 50	605	644	708	723	762	787	826	909	-
		X-T 60	605	644	708	723	762	787	826	909	-
 Width 30, 40, 45, 50, 60 Not available for: MIAMI, VIVA											



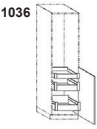
**Planning advice:**  
Take account of opening angle



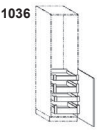
**Planning advice:**  
Take account of opening angle



**Planning advice:**  
Take account of opening angle



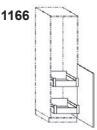
**Planning advice:**  
Take account of opening angle



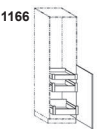
**Planning advice:**  
Take account of opening angle



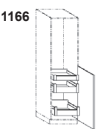
**Planning advice:**  
Take account of opening angle



**Planning advice:**  
Take account of opening angle



**Planning advice:**  
Take account of opening angle



**Planning advice:**  
Take account of opening angle

# Modular system Door / internal drawer / internal pull-out

■ = Models also available in 34/45.5/61 cm carcass depth (Order no.: ... replace ... 55 ... with 34/45/61)  
 □ = Models also available in 45.5/61 cm carcass depth (order no.: replace ... 55 ... with 45/61)

Order no.  
 W H D

Hinge side:	Carcass depth	Price groups											
		1	2	3	4	5	6	7	8	9			
R/L ▲	1166	Door module / internal pull-out 1 door 116.6 cm with wide angle hinges 2 internal drawers 2 internal pull-outs 9 grids	G	X-T 30 117.IA2S25	722	763	826	840	875	902	940	1034	-
				X-T 40 117.IA2S25	722	763	826	840	875	902	940	1034	-
				X-T 45 117.IA2S25	722	763	826	840	875	902	940	1034	-
				X-T 50 117.IA2S25	722	763	826	840	875	902	940	1034	-
				X-T 60 117.IA2S25	722	763	826	840	875	902	940	1034	-
				Width 30, 40, 45, 50, 60 Not available for: MIAMI, VIVA									
R/L ■	1296	Door module / internal drawer 1 door 129.6 cm with wide angle hinges 3 internal drawers 10 grids	G	X-T 30 130.IS355	506	552	621	642	681	708	745	820	-
				X-T 40 130.IS355	506	552	621	642	681	708	745	820	-
				X-T 45 130.IS355	506	552	621	642	681	708	745	820	-
				X-T 50 130.IS355	506	552	621	642	681	708	745	820	-
				X-T 60 130.IS355	506	552	621	642	681	708	745	820	-
				Width 30, 45, 50, 60 Width 40 Not available for: MIAMI, VIVA									
R/L ▲	1296	Door module / internal pull-out 1 door 129.6 cm with wide angle hinges 2 internal pull-outs 10 grids	G	X-T 30 130.IA255	498	543	612	633	671	700	737	811	-
				X-T 40 130.IA255	498	543	612	633	671	700	737	811	-
				X-T 45 130.IA255	498	543	612	633	671	700	737	811	-
				X-T 50 130.IA255	498	543	612	633	671	700	737	811	-
				X-T 60 130.IA255	498	543	612	633	671	700	737	811	-
				Width 30, 45, 50, 60 Width 40 Not available for: MIAMI, VIVA									
R/L ▲	1296	Door module / internal pull-out 1 door 129.6 cm with wide angle hinges 4 internal pull-outs 10 grids	G	X-T 30 130.IA455	843	887	957	970	1009	1036	1073	1180	-
				X-T 40 130.IA455	843	887	957	970	1009	1036	1073	1180	-
				X-T 45 130.IA455	843	887	957	970	1009	1036	1073	1180	-
				X-T 50 130.IA455	843	887	957	970	1009	1036	1073	1180	-
				X-T 60 130.IA455	843	887	957	970	1009	1036	1073	1180	-
				Width 30, 45, 50, 60 Width 40 Not available for: MIAMI, VIVA									
R/L ▲	1296	Door module / internal pull-out 1 door 129.6 cm with wide angle hinges 2 internal drawers 1 internal pull-out 10 grids	G	X-T 30 130.IAS255	561	606	676	694	734	762	799	879	-
				X-T 40 130.IAS255	561	606	676	694	734	762	799	879	-
				X-T 45 130.IAS255	561	606	676	694	734	762	799	879	-
				X-T 50 130.IAS255	561	606	676	694	734	762	799	879	-
				X-T 60 130.IAS255	561	606	676	694	734	762	799	879	-
				Width 30, 45, 50, 60 Width 40 Not available for: MIAMI, VIVA									
R/L ▲	1296	Door module / internal pull-out 1 door 129.6 cm with wide angle hinges 1 internal drawer 2 internal pull-outs 10 grids	G	X-T 30 130.IA2S55	616	660	730	747	787	814	852	937	-
				X-T 40 130.IA2S55	616	660	730	747	787	814	852	937	-
				X-T 45 130.IA2S55	616	660	730	747	787	814	852	937	-
				X-T 50 130.IA2S55	616	660	730	747	787	814	852	937	-
				X-T 60 130.IA2S55	616	660	730	747	787	814	852	937	-
				Width 30, 45, 50, 60 Width 40 Not available for: MIAMI, VIVA									
R/L ▲	1296	Door module / internal pull-out 1 door 129.6 cm with wide angle hinges 2 internal drawers 2 internal pull-outs 10 grids	G	X-T 30 130.IA2S25	734	778	848	862	902	929	968	1065	-
				X-T 40 130.IA2S25	734	778	848	862	902	929	968	1065	-
				X-T 45 130.IA2S25	734	778	848	862	902	929	968	1065	-
				X-T 50 130.IA2S25	734	778	848	862	902	929	968	1065	-
				X-T 60 130.IA2S25	734	778	848	862	902	929	968	1065	-
				Width 30, 45, 50, 60 Width 40 Not available for: MIAMI, VIVA									
R/L ■	1426	Door module / internal drawer 1 door 142.6 cm with wide angle hinges 3 internal drawers 11 grids	G	X-T 30 143.IS355	512	565	640	663	708	735	774	851	-
				X-T 40 143.IS355	512	565	640	663	708	735	774	851	-
				X-T 45 143.IS355	512	565	640	663	708	735	774	851	-
				X-T 50 143.IS355	512	565	640	663	708	735	774	851	-
				X-T 60 143.IS355	512	565	640	663	708	735	774	851	-
				Width 30, 45, 50, 60 Width 40 Not available for: MIAMI, VIVA									
R/L ▲	1426	Door module / internal pull-out 1 door 142.6 cm with wide angle hinges 2 internal pull-outs 11 grids	G	X-T 30 143.IA255	502	557	630	654	700	726	766	843	-
				X-T 40 143.IA255	502	557	630	654	700	726	766	843	-
				X-T 45 143.IA255	502	557	630	654	700	726	766	843	-
				X-T 50 143.IA255	502	557	630	654	700	726	766	843	-
				X-T 60 143.IA255	502	557	630	654	700	726	766	843	-
				Width 30, 45, 50, 60 Width 40 Not available for: MIAMI, VIVA									

# Modular system Door / internal drawer / internal pull-out

■ = Models also available in 34/45.5/61 cm carcass depth (Order no.: ... replace ... 55 ... with 34/45/61)  
 □ = Models also available in 45.5/61 cm carcass depth (order no.: replace ... 55 ... with 45/61)

Order no.  
W H D

Hinge side:	Carcass depth	Price groups										
		1	2	3	4	5	6	7	8	9		
1426	G	X-T 30 143.IA455	R/L ▲	848	901	975	990	1036	1063	1102	1212	-
		X-T 40 143.IA455	R/L ▲	848	901	975	990	1036	1063	1102	1212	-
		X-T 45 143.IA455	R/L ▲	848	901	975	990	1036	1063	1102	1212	-
		X-T 50 143.IA455	R/L ▲	848	901	975	990	1036	1063	1102	1212	-
		X-T 60 143.IA455	R/L ▲	848	901	975	990	1036	1063	1102	1212	-
		Width 30, 45, 50, 60 Width 40 Not available for: MIAMI, VIVA										
1426	G	X-T 30 143.IAS255	R/L ▲	566	620	693	717	762	788	828	911	-
		X-T 40 143.IAS255	R/L ▲	566	620	693	717	762	788	828	911	-
		X-T 45 143.IAS255	R/L ▲	566	620	693	717	762	788	828	911	-
		X-T 50 143.IAS255	R/L ▲	566	620	693	717	762	788	828	911	-
		X-T 60 143.IAS255	R/L ▲	566	620	693	717	762	788	828	911	-
		Width 30, 45, 50, 60 Width 40 Not available for: MIAMI, VIVA										
1426	G	X-T 30 143.IA2S55	R/L ▲	621	675	747	770	814	842	881	969	-
		X-T 40 143.IA2S55	R/L ▲	621	675	747	770	814	842	881	969	-
		X-T 45 143.IA2S55	R/L ▲	621	675	747	770	814	842	881	969	-
		X-T 50 143.IA2S55	R/L ▲	621	675	747	770	814	842	881	969	-
		X-T 60 143.IA2S55	R/L ▲	621	675	747	770	814	842	881	969	-
		Width 30, 45, 50, 60 Width 40 Not available for: MIAMI, VIVA										
1426	G	X-T 30 143.IA2S25	R/L ▲	738	791	865	885	929	956	995	1095	-
		X-T 40 143.IA2S25	R/L ▲	738	791	865	885	929	956	995	1095	-
		X-T 45 143.IA2S25	R/L ▲	738	791	865	885	929	956	995	1095	-
		X-T 50 143.IA2S25	R/L ▲	738	791	865	885	929	956	995	1095	-
		X-T 60 143.IA2S25	R/L ▲	738	791	865	885	929	956	995	1095	-
		Width 30, 45, 50, 60 Width 40 Not available for: MIAMI, VIVA										
1556	NEW G	X-T 30 156.IAE355	R/L ■	512	554	638	677	745	785	844	928	-
		X-T 40 156.IAE355	R/L ■	512	554	638	677	745	785	844	928	-
		X-T 45 156.IAE355	R/L ■	512	554	638	677	745	785	844	928	-
		X-T 50 156.IAE355	R/L ■	512	554	638	677	745	785	844	928	-
		X-T 60 156.IAE355	R/L ■	512	554	638	677	745	785	844	928	-
		Width 30, 40, 45, 50, 60 Not available for: CASTELLO, FRAME, MUNICH, NEVADA, VINO, VIVA										
1556	NEW G	X-T 30 156.IAS355	R/L ■	811	853	934	975	1043	1085	1143	1257	-
		X-T 40 156.IAS355	R/L ■	811	853	934	975	1043	1085	1143	1257	-
		X-T 45 156.IAS355	R/L ■	811	853	934	975	1043	1085	1143	1257	-
		X-T 50 156.IAS355	R/L ■	811	853	934	975	1043	1085	1143	1257	-
		X-T 60 156.IAS355	R/L ■	811	853	934	975	1043	1085	1143	1257	-
		Width 30, 40, 45, 50, 60 Not available for: CASTELLO, FRAME, MUNICH, NEVADA, VINO, VIVA										
1556	NEW G	X-T 30 156.IA2E25	R/L ▲	652	693	776	816	885	925	983	1081	-
		X-T 40 156.IA2E25	R/L ▲	652	693	776	816	885	925	983	1081	-
		X-T 45 156.IA2E25	R/L ▲	652	693	776	816	885	925	983	1081	-
		X-T 50 156.IA2E25	R/L ▲	652	693	776	816	885	925	983	1081	-
		X-T 60 156.IA2E25	R/L ▲	652	693	776	816	885	925	983	1081	-
		Width 30, 40, 45, 50, 60 Not available for: CASTELLO, FRAME, MUNICH, NEVADA, VINO, VIVA										
1556	NEW G	X-T 30 156.IA455	R/L □	973	1014	1097	1137	1206	1248	1305	1436	-
		X-T 40 156.IA455	R/L □	973	1014	1097	1137	1206	1248	1305	1436	-
		X-T 45 156.IA455	R/L □	973	1014	1097	1137	1206	1248	1305	1436	-
		X-T 50 156.IA455	R/L □	973	1014	1097	1137	1206	1248	1305	1436	-
		X-T 60 156.IA455	R/L □	973	1014	1097	1137	1206	1248	1305	1436	-
		Width 30, 40, 45, 50, 60 Not available for: CASTELLO, FRAME, MUNICH, NEVADA, VINO, VIVA										
1556	NEW G	X-T 30 156.E455	R/L ■	331	372	455	495	563	605	663	729	-
		X-T 40 156.E455	R/L ■	331	372	455	495	563	605	663	729	-
		X-T 45 156.E455	R/L ■	331	372	455	495	563	605	663	729	-
		X-T 50 156.E455	R/L ■	331	372	455	495	563	605	663	729	-
		X-T 60 156.E455	R/L ■	331	372	455	495	563	605	663	729	-
		Width 30, 40, 45, 50, 60 Not available for: CASTELLO, FRAME, MUNICH, NEVADA, VINO, VIVA										



# Modular system Door / internal drawer / internal pull-out

■ = Models also available in 34/45/61 cm carcass depth (Order no.: ... replace ... 55 ... with 34/45/61)  
 □ = Models also available in 45,5/61 cm carcass depth (order no.: replace ... 55 ... with 45/61)

Order no.  
W H D

Hinge side:	Carcass depth	Price groups								
		1	2	3	4	5	6	7	8	9
R/L	□	400	440	524	563	631	672	730	803	-
R/L	□	400	440	524	563	631	672	730	803	-
R/L	□	400	440	524	563	631	672	730	803	-
R/L	□	400	440	524	563	631	672	730	803	-
R/L	□	400	440	524	563	631	672	730	803	-

**1556 Door module**  
 1 door 155.6 cm with tightening fitting  
 1 hook rail  
 1 storage basket  
 1 bottom shelf  
 12 grids

<b>G</b>	<b>X-T 30 156.HK55</b>	R/L	□	400	440	524	563	631	672	730	803	-
	<b>X-T 40 156.HK55</b>	R/L	□	400	440	524	563	631	672	730	803	-
	<b>X-T 45 156.HK55</b>	R/L	□	400	440	524	563	631	672	730	803	-
	<b>X-T 50 156.HK55</b>	R/L	□	400	440	524	563	631	672	730	803	-
	<b>X-T 60 156.HK55</b>	R/L	□	400	440	524	563	631	672	730	803	-

Width 30, 40, 45, 50, 60 Not available for: CASTELLO, FRAME, MUNICH, NEVADA, VINO, VIVA



















## Modular system Appliance unit Apertures variable

	<b>Aperture module, variable</b> Aperture height 10 - 182 cm	10,0-180,0	<b>X-N1.V</b>			0								
		<b>G</b>												
	<b>Double aperture module, variable</b> Aperture height per 10 - 140 cm	10,0-140,0	<b>X-N2.V</b>			11								
		<b>G</b>												
	<b>Triple aperture module, variable</b> Aperture height per 10 - 140 cm	10,0-140,0	<b>X-N3.V</b>			22								
		<b>G</b>												









## Modular system Tall units

	<b>Flap door module 26</b> 1 flap door 25.6 cm 1 bottom shelf 2 grids		<b>X-K 30 26</b>			64	73	86	105	123	139	162	178	-
			<b>X-K 40 26</b>			64	73	86	105	123	139	162	178	-
			<b>X-K 45 26</b>			64	73	86	105	123	139	162	178	-
			<b>X-K 50 26</b>			64	73	86	105	123	139	162	178	-
			<b>X-K 60 26</b>			64	73	86	105	123	139	162	178	-
	<b>Flap door module 32</b> 1 flap door 32.1 cm 1 bottom shelf 2.5 grids		<b>X-K 30 32</b>			70	88	109	125	148	169	190	209	-
			<b>X-K 40 32</b>			70	88	109	125	148	169	190	209	-
			<b>X-K 45 32</b>			70	88	109	125	148	169	190	209	-
			<b>X-K 50 32</b>			70	88	109	125	148	169	190	209	-
			<b>X-K 60 32</b>			70	88	109	125	148	169	190	209	-
				Width 30, 40, 45, 50, 60 Not available for: MIAMI, VIVA										
	<b>Flap door module 39</b> 1 flap door 38.6 cm 1 bottom shelf 3 grid		<b>X-K 30 39</b>			70	88	109	125	148	169	190	209	-
			<b>X-K 40 39</b>			70	88	109	125	148	169	190	209	-
			<b>X-K 45 39</b>			70	88	109	125	148	169	190	209	-
			<b>X-K 50 39</b>			70	88	109	125	148	169	190	209	-
			<b>X-K 60 39</b>			70	88	109	125	148	169	190	209	-
	<b>Lifting door module 39</b> 1 lifting door 38.6 cm 1 bottom shelf 3 grid		<b>X-TL 60 39</b>			211	215	246	264	275	284	343	377	-
			Maximum appliance dimensions Lifting door 38.6 cm high: H: 33.5 cm W: 49.6 cm D: 51.0 cm											
	<b>Lifting door module 47 cm</b> 1 lifting door 46.9 cm 1 bottom shelf maximum appliance dimensions H: 37.6 cm W: 49.6 cm D: 51 cm		<b>X-TL 60 47</b>			226	235	273	297	311	322	383	421	-
			Width 60 Not available for: MIAMI, VIVA											
			Note: The lifting door covers an appliance aperture of 45 cm. Therefore, if a replacement is required after a number years, the installation of compact appliances, such as a steam cooker, is possible.											
	<b>Lifting door module 52</b> 1 lifting door 51.6 cm 1 bottom shelf 4 grids		<b>X-TL 60 52</b>			226	235	273	297	311	322	383	421	-
<b>Panel module above apertures</b>			<b>X-NBA</b>			47	48	50	56	71	85	107	118	-


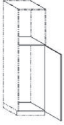







## Modular system Appliance unit Apertures microwave/oven

				Price groups										
Order no. W H D				Hinge side:	Carcase depth	1	2	3	4	5	6	7	8	9
	<b>Oven aperture module variable</b> Aperture height variable from 10 - 182 cm 1 panel above		<b>X-NOB100.V</b>			47	48	50	56	71	85	107	118	-
	<b>Oven aperture module variable in 2 ways</b> Aperturen height variable from 10 - 150 cm 2 open apertures 1 panel above	 	<b>X-NOB200.V</b>			56	58	60	68	83	95	117	129	-
	<b>Oven aperture module variable in 3 ways</b> Aperture height variable from 10 - 150 cm 3 open apertures 1 panel above	  	<b>X-NOB300.V</b>			68	69	71	77	93	108	126	139	-
	<b>Oven aperture module variable</b> Aperture height variable from 10 - 182 cm 1 open aperture		<b>X-NO100.V</b>			0	0	0	0	0	0	0	0	-
	<b>Oven aperture module variable in 2 ways</b> Aperturen height variable from 10 - 150 cm 2 open apertures	 	<b>X-NO200.V</b>			11	11	11	11	11	11	11	12	-
	<b>Oven aperture module variable in 3 ways</b> Aperture height variable from 10 - 150 cm 3 open apertures	  	<b>X-NO300.V</b>			22	22	22	22	22	22	22	24	-


## Modular system Appliance unit Apertures

776		<b>Module for refrigerator appliance aperture</b> aperture height 58-72 cm For refrigerator 1 door 77.6 cm 1 bottom shelf Hinge versions depending on appliance specified 6 grids	 <b>G</b>	<b>X-NI72V.7855</b>	R/L ▲	103	123	164	186	218	239	269	296	-
906		<b>Module for refrigerator appliance aperture</b> aperture height 58-87.6 cm For refrigerator 1 door 90.6 cm 1 bottom shelf Hinge versions depending on appliance specified 7 grids	 <b>G</b>	<b>X-NI88V.9155</b>	R/L ▲	112	139	186	211	245	263	299	329	-
1036		<b>Module for refrigerator appliance aperture</b> aperture height 72-88 cm For refrigerator 1 door 103.6 cm 1 bottom shelf Hinge versions depending on appliance specified 8 grids	 <b>G</b>	<b>X-NI88V.10455</b>	R/L ▲	123	149	210	233	269	294	329	362	-
1166		<b>Module for refrigerator appliance aperture</b> aperture height 88-102.5 cm For refrigerator 1 door 116.6 cm 1 bottom shelf Hinge versions depending on appliance specified 9 grids	 <b>G</b>	<b>X-NI103V.11755</b>	R/L ▲	126	166	230	258	295	321	360	396	-







## Modular system Appliance unit Apertures

		Order no. W H D			Price groups										
					Hinge side: ▲	Carcass depth	1	2	3	4	5	6	7	8	9
1296		<b>Module for refrigerator appliance aperture</b> aperture height 88-122.5 cm For refrigerator 1 door 129.6 cm 1 bottom shelf Hinge versions depending on appliance specified 10 grids	88,0- 125,5 <b>G</b>	<b>X-NI123V.13055</b>	R/L	▲	139	183	253	282	321	349	385	424	-
1426		<b>Module for refrigerator appliance aperture</b> aperture height 88-122.5 cm For refrigerator 1 door 142.6 cm 1 bottom shelf Hinge versions depending on appliance specified 11 grids	88,0- 125,5 <b>G</b>	<b>X-NI123V.14355</b>	R/L	▲	144	198	271	303	349	374	416	458	-
386 906		<b>Module for refrigerator appliance aperture</b> aperture height 122.5 cm For fridge-freezer combination 1 door 38.6 cm 1 door 90.6 cm 1 bottom shelf Hinge versions depending on appliance specified 10 grids	122,5 <b>G</b>	<b>X-NI123V.913955</b>	R/L	▲	172	218	283	329	384	423	481	529	-
386 1166		<b>Module for refrigerator appliance aperture</b> Aperture height 140/144.6 cm For fridge-freezer combination 1 door 38.6 cm 1 door 116.6 cm 1 bottom shelf Hinge versions depending on appliance specified 12 grids	140,0- 144,6 <b>G</b>	<b>X-NI145X1.156V2</b>	R/L		189	249	330	374	435	481	541	595	-
646 1166		<b>Module for refrigerator appliance aperture</b> Aperture height 102.5 - 178 cm For refrigerator 1 door 64.6 cm attached to 1 door 116.6 cm 1 bottom shelf Hinge versions depending on appliance specified 14 grids	102,5- 178,0 <b>G</b>	<b>X-NI178V.117655</b>	R/L	▲	214	277	371	421	483	533	598	658	-
1036 776		<b>Module for refrigerator appliance aperture</b> Aperture height 102.5 - 178 cm For refrigerator 1 door 103.6 cm attached to 1 door 77.6 cm 1 bottom shelf Hinge versions depending on appliance specified 14 grids	102,5- 178,0 <b>G</b>	<b>X-NI178V.781045</b>	R/L	▲	227	275	374	419	488	534	598	658	-
906 906		<b>Module for refrigerator appliance aperture</b> Aperture height 102.5 - 178 cm For refrigerator 1 door 90.6 cm attached to 1 door 90.6 cm 1 bottom shelf Hinge versions depending on appliance specified 14 grids	102,5- 178,0 <b>G</b>	<b>X-NI178V.919155</b>	R/L	▲	223	278	369	423	489	528	598	658	-
1166 776		<b>Module for refrigerator appliance aperture</b> aperture height 178 cm For refrigerator 1 door 116.6 cm 1 door 77.6 cm 1 bottom shelf Hinge versions depending on appliance specified 15 grids	178,0 <b>G</b>	<b>X-NI178X4.195V2</b>	R/L		235	288	395	444	513	557	628	691	-
1296 776		<b>Module for refrigerator appliance aperture</b> aperture height 178 cm For refrigerator 1 door 129.6 cm 1 door 77.6 cm 1 bottom shelf Hinge versions depending on appliance specified 16 grids	178,0 <b>G</b>	<b>X-NI178X4.208V2</b>	R/L		227	273	374	419	488	532	598	658	-

## Modular system Apertures







1296 776		<b>Oven aperture module</b> Aperture height 24.2 - 37.2 cm for microwave 1 compensation panel 3 grid	24,2- 37,2 <b>G</b>	<b>X-NI1B.37V</b>			47	48	50	56	71	85	107	118	-
-------------	---	---	---------------------------	-------------------	--	--	----	----	----	----	----	----	-----	-----	---

## Modular system Apertures

		Order no. W H D	Hinge side: Carcase depth	Price groups								
				1	2	3	4	5	6	7	8	9
	<b>Oven aperture module</b> aperture height 36.9 - 49.8 cm For microwave, compact oven, steam oven 1 compensation panel 4 grids	 <b>X-N1B.49V</b> <b>G</b>		47	48	50	56	71	85	107	118	-
	<b>Oven aperture module</b> Aperture height 37.6 - 60.7 cm for e.g. oven 1 compensation panel 5 grids	 <b>X-N1B.61V</b> <b>G</b>		47	48	50	56	71	85	107	118	-
	<b>Aperture module, variable</b> Aperture height 10 - 182 cm	 <b>X-N1.V</b> <b>G</b>		0								
	<b>Aperture module, fixed panel</b> 1 panel 12.6 cm = 1 grids Panel fixed to carcase	<b>G</b>		47	48	50	56	71	85	107	118	-
		<b>X-B 30 13</b>		47	48	50	56	71	85	107	118	-
		<b>X-B 40 13</b>		47	48	50	56	71	85	107	118	-
		<b>X-B 45 13</b>		47	48	50	56	71	85	107	118	-
		<b>X-B 50 13</b>		47	48	50	56	71	85	107	118	-
		<b>X-B 60 13</b>		47	48	50	56	71	85	107	118	-
		<b>X-B 80 13</b>		63	65	68	86	109	140	156	172	-
		<b>X-B 90 13</b>		63	65	68	86	109	140	156	172	-
		<b>X-B 100 13</b>		63	65	68	86	109	140	156	172	-
		<b>X-B 120 13</b>		63	65	68	86	109	140	156	172	-

## Modular system Appliance unit Apertures SERVO-DRIVE flex

**Note:** The modules with SERVO DRIVE flex are **not** available with cooling unit in plinth or refrigerator with pull-outs.

1036		<b>Refrigerator aperture module</b> aperture height 88-92 cm For refrigerator 1 inside panel removable 1 fixed shelf for drive unit 1 door 103.6 cm 1 bottom shelf With preparation for SERVO-DRIVE flex Incl. drive unit and mains unit as well as SERVO-DRIVE switch and wireless receiver Cable length 160 m Hinge versions depending on appliance specified	 <b>X-NT92V.10455</b> <b>G</b>	R/L ▲	936	966	1025	1028	1064	1089	1126	1239	-
1166		<b>Refrigerator aperture module</b> aperture height 88-105 cm For refrigerator 1 inside panel removable 1 fixed shelf for drive unit 1 door 116.6 cm 1 bottom shelf With preparation for SERVO-DRIVE flex Incl. drive unit and mains unit as well as SERVO-DRIVE switch and wireless receiver Cable length 160 m Hinge versions depending on appliance specified	 <b>X-NT105V.11755</b> <b>G</b>	R/L ▲	942	981	1044	1054	1090	1115	1153	1268	-
1426		<b>Refrigerator aperture module</b> aperture height 103-131 cm For refrigerator 1 inside panel removable 1 fixed shelf for drive unit 1 door 142.6 cm 1 bottom shelf With preparation for SERVO-DRIVE flex Incl. drive unit and mains unit as well as SERVO-DRIVE switch and wireless receiver Cable length 160 m Hinge versions depending on appliance specified	 <b>X-NT131V.14355</b> <b>G</b>	R/L ▲	958	1012	1085	1098	1143	1171	1211	1332	-


# Modular system Appliance unit Apertures SERVO-DRIVE flex

**Note:**  
The modules with SERVO DRIVE flex are not available with cooling unit in plinth or refrigerator with pull-outs.

Order no.  
W H D

		Price groups								
Hinge side:	Carcass depth	1	2	3	4	5	6	7	8	9
R/L ▲		1044	1106	1208	1237	1310	1355	1423	1565	-
R/L ▲		1804	1869	1978	1992	2064	2113	2179	2397	-
R/L		1804	1869	1978	1992	2064	2113	2179	2397	-
R/L ▲		958	1012	1085	1098	1143	1171	1211	1332	-
R/L ▲		1137	1202	1313	1362	1435	1484	1551	1706	-
R/L ▲		1142	1217	1332	1385	1463	1509	1578	1736	-


**1166**  
**776**



**Refrigerator aperture module**  
aperture height 140-177.8 cm  
For refrigerator  
1 inside panel removable  
1 fixed shelf for drive unit  
1 door 116.6 cm attached to 1 door 77.6 cm  
1 bottom shelf  
With preparation for SERVO-DRIVE flex incl. drive unit and mains unit as well as SERVO-DRIVE switch and wireless receiver  
Cable length 160 m  
Hinge versions depending on appliance specified

**140,0-177,8**  
**G**  
**X-NT178V.781175**


**1296**  
**776**



**Refrigerator aperture module**  
aperture height 178-188 cm  
For refrigerator  
1 inside panel removable  
1 fixed shelf for drive unit  
1 door 129.6 cm attached to 1 door 77.6 cm  
1 fixed shelf for drive unit  
1 inside panel removable  
1 bottom shelf  
With preparation for SERVO-DRIVE flex  
Incl. 2 drive units and mains units as well as SERVO-DRIVE switch and wireless receiver  
Cable length 160 m  
Hinge versions depending on appliance specified

**178,0-188,0**  
**G**  
**X-NT188V.781305**


**1296**  
**776**



**Refrigerator aperture module**  
aperture height 178 cm  
For refrigerator, 2-door  
1 inside panel removable  
1 fixed shelf for drive unit  
1 door 129.6 cm  
1 door 77.6 cm  
1 fixed shelf for drive unit  
1 inside panel removable  
1 bottom shelf  
With preparation for SERVO-DRIVE flex  
Incl. 2 drive units and mains units as well as SERVO-DRIVE switch and wireless receiver  
Cable length 160 m  
Hinge versions depending on appliance specified

**178,0**  
**G**  
**X-NT177S3.78130**


**140,0-177,8**  
**G**




**Refrigerator aperture module**  
aperture height 140-177.8 cm  
1 inside panel removable  
1 fixed shelf for drive unit  
1 door 194.6 cm  
The tightening fitting will be replaced with carrying-door technology on appliance units.  
1 bottom shelf  
With preparation for SERVO-DRIVE flex incl. drive unit and mains unit as well as SERVO-DRIVE switch and wireless receiver  
Cable length 160 m  
Hinge versions depending on appliance specified

**X-NT178V.19555**  
R/L ▲

**Width 60 Not available for:** ALUELEMENTS, ATLANTA-B, ATLANTA-S, BERGEN, CASTELLO, CHALET-B, CHALET-S, CHICAGO, FRAME, LUGANO, LUX-B, MIAMI, MODENA, MUNICH, NEVADA, NOBEL-B, NOBEL-S, ORLANDO-B, ORLANDO-S, OSLO 15, PADUA, SOFIE-B, SOFIE-S, TESSIN 15, TIM 15, VINO, VIVA, YORK-B, YORK-S

 Please follow the fitting instructions from the appliance manufacturers.


**140,0-177,8**  
**G**




**Refrigerator aperture module**  
aperture height 140-177.8 cm  
1 inside panel removable  
1 fixed shelf for drive unit  
1 door 207.6 cm  
The tightening fitting will be replaced with carrying-door technology on appliance units.  
1 bottom shelf  
With preparation for SERVO-DRIVE flex incl. drive unit and mains unit as well as SERVO-DRIVE switch and wireless receiver  
Cable length 160 m  
Hinge versions depending on appliance specified

**X-NT178V.20855**  
R/L ▲

**Width 60 Not available for:** ALUELEMENTS, ATLANTA-B, ATLANTA-S, BERGEN, CASTELLO, CHALET-B, CHALET-S, CHICAGO, FRAME, GARDA, LUGANO, LUX-B, MIAMI, MODENA, MUNICH, NEVADA, NOBEL-B, NOBEL-S, ORLANDO-B, ORLANDO-S, OSLO 15, PADUA, SOFIE-B, SOFIE-S, TESSIN 15, TIM 15, TREND, VINO, VIVA, YORK-B, YORK-S

 Please follow the fitting instructions from the appliance manufacturers


**140,0-177,8**  
**G**



**Refrigerator aperture module**  
aperture height 140-177.8 cm  
1 inside panel removable  
1 fixed shelf for drive unit  
1 door 220.6 cm  
The tightening fitting will be replaced with carrying-door technology on appliance units.  
1 bottom shelf  
With preparation for SERVO-DRIVE flex incl. drive unit and mains unit as well as SERVO-DRIVE switch and wireless receiver  
Cable length 160 m  
Hinge versions depending on appliance specified

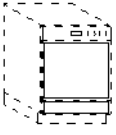
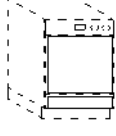

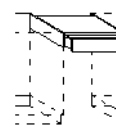
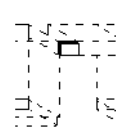

**X-NT178V.22155**  
R/L ▲

**Width 60 Not available for:** ALUELEMENTS, ATLANTA-B, ATLANTA-S, BERGEN, CASTELLO, CHALET-B, CHALET-S, CHICAGO, FRAME, GARDA, LUGANO, LUX-B, MIAMI, MODENA, MUNICH, NEVADA, NOBEL-B, NOBEL-S, ORLANDO-B, ORLANDO-S, OSLO 15, PADUA, SOFIE-B, SOFIE-S, TESSIN 15, TIM 15, TREND, VINO, VIVA, YORK-B, YORK-S

 Please follow the fitting instructions from the appliance manufacturers

# Accessories

■ = Models also available in 34/45.5/61 cm carcass depth (Order no.: ... replace ... 55 ... with 34/45/61)  
 □ = Models also available in 45.5/61 cm carcass depth (order no.: replace ... 55 ... with 45/61)


	Order no.	W	H	D	Hinge side:	Carcass depth	Price groups								
							1	2	3	4	5	6	7	8	9
 <p><b>Front decor panels</b>                      Price group 1 - 3:                      laminate in front decor or smooth lacquering                      Price group 4 - 7:                      smooth veneer, smooth lacquering or laminate                      Dimensions: 59.5 x 87.5 cm, dimensions: 59.5 x 122.0 cm</p>	<b>GFP 60 90</b>						30	31	82	113	271	271	271	298	-
	<b>GFP 60 120</b>						37	39	116	158	378	378	378	416	-
							<p><b>Note:</b>                      Not available for: TOP 1251/2/4; TOP 1256/7/9, TOP 1296-1309, TOP 1346-1364 TOP 1396/9, TOP 1421/4, TOP 1431/4, TOP 1441-1449, TOP 1486/9 TOP 1586-1589, TREND 1581-1584, TREND 1596-1599 SHERWOOD, PUR, EDITION, CASA-B, SIGNUM-B, MIAMI, FRAME, SMART, SMART-M, VILLAGE 15-S, VILLAGE 15-B, SOFIE-S, SOFIE-B, FENIX-INOX, SMART MIRROR, OSLO 15, LUGANO, TESSIN 15, BAVARIA, MONTANA, NEVADA; PADUA, MODENA, FLORENZ</p>								
 <p><b>Front decor panels</b>                      Price group 1 - 3:                      laminate in front decor or smooth lacquering                      Price group 4 - 7:                      smooth veneer, smooth lacquering or laminate</p>	per m <sup>2</sup> , W x H														
	<b>DP 00</b>						49	51	156	213	513	513	513	564	-
	<b>minimum price</b>						24	25	77	107	257	257	257	283	-
							<p><b>Note:</b> Price per m<sup>2</sup>. Minimum price: 0.5 m<sup>2</sup>                      Not available for: TOP 1251/2/4; TOP 1256/7/9, TOP 1296-1309, TOP 1346-1364 TOP 1396/9, TOP 1421/4, TOP 1431/4, TOP 1441-1449, TOP 1486/9 TOP 1586-1589, TREND 1581-1584, TREND 1596-1599 SHERWOOD, PUR, EDITION, CASA-B, SIGNUM-B, MIAMI, FRAME, SMART, SMART-M, VILLAGE 15-S, VILLAGE 15-B, SOFIE-S, SOFIE-B, FENIX-INOX, SMART MIRROR, OSLO 15, LUGANO, TESSIN 15, BAVARIA, MONTANA, NEVADA; PADUA, MODENA, FLORENZ</p>								
<p><b>1 lifting door fitting with front 38.6 cm</b>                      59.6 cm wide</p>	<b>E-LTG 60 39</b>						211	215	246	264	275	284	343	377	-
 <p><b>Pull-out table (extendable by 81.5 cm)</b>                      for installation in                      50 or 60 cm wide units                      Pull-out table, stainless steel-coloured                      (instead of a drawer, without panel)                      max. load 30 kg</p>	<b>AZ</b>						316								
							<p><b>Important!</b>                      Installation above a structural shelf is not possible                      Only available in combination with carcass depth 55.5 cm</p>								
<p>126</p>  <p><b>Drawer element</b>                      With top shelf                      1 drawer 12.6 cm for installation under worktops                      height 13 cm</p>	<b>U 30 13 55 10</b>	■	178	181	194	237	237	250	268	295	-				
	<b>U 40 13 55 10</b>	■	178	181	194	237	237	250	268	295	-				
	<b>U 45 13 55 10</b>	■	178	181	194	237	237	250	268	295	-				
	<b>U 50 13 55 10</b>	■	178	181	194	237	237	250	268	295	-				
	<b>U 60 13 55 10</b>	■	178	181	194	237	237	250	268	295	-				
	<b>U 70 13 55 10</b>	■	250	257	277	340	340	357	386	425	-				
	<b>U 80 13 55 10</b>	■	250	257	277	340	340	357	386	425	-				
	<b>U 90 13 55 10</b>	■	250	257	277	340	340	357	386	425	-				
	<b>U 100 13 55 10</b>	■	278	288	310	371	371	385	418	460	-				
	<b>U 120 13 55 10</b>	■	294	299	322	389	389	403	436	480	-				
			<p>Width 30, 40, 45, 50, 60, 80, 90, 100, 120                      Width 70 Not available for: ALUELEMENTS, MIAMI, STRIP ELEMENTS, VIVA</p>												
<p>126</p>  <p><b>Drawer element</b>  <b>Front filler</b>                      5 - 20 cm</p>	<b>UP 20 13</b>		40	40	40	71	71	71	77	85	-				
 <p><b>Anti-tilting safety device</b>  <b>Mounting set for base units</b>                      Fastening set for base cabinets for screwing                      or gluing with glue for floor mounting, can be                      planned from a plinth height of 10 cm                      1 set suitable for 1 base unit</p>	<b>KS</b>		39												
			<p><b>Note:</b>                      Mounting hardware is not included in the scope of delivery and must therefore be obtained by the customer. Base units - whether standing against the wall or used in island form - must also be secured in place to prevent them from toppling over.                      Attention: Gluing on laminate, PVC and linoleum floors is not permitted!                      For free-standing base units, KS-U is added automatically.</p>												
<p><b>Extra charge for base units with closed top shelf</b>                      not available for                      Diagonal and corner base units</p>	<b>MP-KBOG</b>		100												
<p><b>Set spacer strips</b></p>	<b>DLI</b>		52												
<p><b>Internal pull-out with 1 spacer strip to compensate for the hinge</b>                      for installation behind doors                      for base and tall units                      The width of the internal pull-outs is 2.5 cm narrower than the nominal dimension.</p>	<b>E-IAZ4555D</b>		227												
	<b>E-IAZ5055D</b>		230												
	<b>E-IAZ6055D</b>		234												
<p><b>Variable width of drawers/pull-outs</b>  <b>Price calculation:</b> Article SA50BU must be taken into account.                      Extra charge refers to next largest element.</p>	<b>SA50BSK</b>		48												
	<b>SA50BAZ</b>		57												
			<p><b>Note:</b>                      all handles N..., base units with connected panels, design fronts G1, G2, G2S, G5S, G6</p>												
<p><b>Surcharge for width reductions of base cabinets with drawers / pull-outs</b></p>	<b>SA50BKU</b>		260												
			<p><b>Note:</b>                      all handles N..., base units with connected panels, design fronts G1, G2, G2S, G5S, G6                      The cabinet width reduction is included in this surcharge.</p>												



# Accessories

■ = Models also available in 34/45.5/61 cm carcass depth (Order no.: ... replace ... 55 ... with 34/45/61)  
 □ = Models also available in 45.5/61 cm carcass depth (order no.: replace ... 55 ... with 45/61)

Order no.  
W H D

Hinge side: Carcass depth	Price groups								
	1	2	3	4	5	6	7	8	9
	57								
 <b>Not available for:</b> all handles N..., base units with connected panels, design fronts G1, G2, G2S, G5S, G6									

**Extra charge for width reduction 1 pull-out of 31-119 cm**

SA50BAZ

## Adjustable shelves

Order no.  
W H D

Hinge side: Carcass depth	Decor groups								
	M10	M20	M30	M40	M50	M60	M70	M80	M90



**Adjustable shelves incl. shelf supports**  
For wall and base units 34 cm deep

- 20 cm
- 25 cm
- 30 cm
- 40 cm
- 45 cm
- 50 cm
- 60 cm
- 80 cm
- 90 cm
- 100 cm
- 120 cm

Z	21	H	20	13,70	-	-	-	52	-	52	70	-
Z	21	H	25	13,70	-	-	-	52	-	52	70	-
Z	21	H	30	13,70	-	-	-	52	-	52	70	-
Z	21	H	40	18,70	-	-	-	71	-	71	95	-
Z	21	H	45	21	-	-	-	82	-	82	110	-
Z	21	H	50	23,50	-	-	-	91	-	91	122	-
Z	21	H	60	28,90	-	-	-	111	-	111	147	-
Z	21	H	80	33	-	-	-	124	-	124	166	-
Z	21	H	90	38	-	-	-	141	-	141	191	-
Z	21	H	100	41	-	-	-	158	-	158	211	-
Z	21	H	120	49	-	-	-	191	-	191	255	-



**Adjustable shelves incl. shelf supports**  
For base and tall units 55.5 cm deep

- 20 cm
- 25 cm
- 30 cm
- 40 cm
- 45 cm
- 50 cm
- 60 cm
- 80 cm
- 90 cm
- 100 cm
- 120 cm

Z	21	U	20	13,70	-	-	-	53	-	53	71	-
Z	21	U	25	17,20	-	-	-	69	-	69	93	-
Z	21	U	30	22,30	-	-	-	86	-	86	116	-
Z	21	U	40	31	-	-	-	118	-	118	159	-
Z	21	U	45	34	-	-	-	134	-	134	179	-
Z	21	U	50	40	-	-	-	149	-	149	202	-
Z	21	U	60	47	-	-	-	182	-	182	246	-
Z	21	U	80	56	-	-	-	223	-	223	299	-
Z	21	U	90	65	-	-	-	252	-	252	338	-
Z	21	U	100	71	-	-	-	281	-	281	376	-
Z	21	U	120	86	-	-	-	340	-	340	455	-



**Adjustable shelves for carcass depth 60.5 cm**  
suitable for fall cupboards and coat stands incl. shelf supports

- 45 cm
- 50 cm
- 60 cm
- 90 cm
- 100 cm

Z21G45-60	37	-	-	-	147	-	147	197	-
Z21G50-60	45	-	-	-	164	-	164	223	-
Z21G60-60	51	-	-	-	200	-	200	270	-
Z21G90-60	71	-	-	-	278	-	278	372	-
Z21G100-60	78	-	-	-	310	-	310	414	-



**Adjustable shelves incl. shelf supports**  
For base and tall units 45.5 cm deep

- 20 cm
- 25 cm
- 30 cm
- 40 cm
- 45 cm
- 50 cm
- 60 cm
- 80 cm
- 90 cm
- 100 cm
- 120 cm

Z	21	U	20-45	11,20	-	-	-	45	-	45	58	-
Z	21	U	25-45	13,70	-	-	-	55	-	55	74	-
Z	21	U	30-45	17,20	-	-	-	69	-	69	92	-
Z	21	U	40-45	23,50	-	-	-	94	-	94	126	-
Z	21	U	45-45	27,80	-	-	-	109	-	109	144	-
Z	21	U	50-45	32	-	-	-	120	-	120	162	-
Z	21	U	60-45	39	-	-	-	146	-	146	198	-
Z	21	U	80-45	46	-	-	-	172	-	172	233	-
Z	21	U	90-45	50	-	-	-	198	-	198	263	-
Z	21	U	100-45	55	-	-	-	218	-	218	294	-
Z	21	U	120-45	67	-	-	-	264	-	264	355	-

M 10	M 20	M 30	M 40	M 50
K M10 laminate				B M50 Velvet Lacquer S M50 Microstructure Lacquer
M 60	M 70	M 80	M 90	
	F M70 veneer / oak / walnut Z M70 Veneer / Bavaria	H M80 high gloss-Lacquer M M80 Matt-Lacquer		



# Drawers / Pull-outs

■ = Models also available in 34/45.5/61 cm carcass depth (Order no.: ... replace ... 55 ... with 34/45/61)

Order no.

Price



**Drawer without front for carcass depths 34 cm, 45.5 cm and 55.5 cm**  
With cushioned self-closing mechanism and full pull-out  
Incl. guides

Ill. shows Legrabox pure Art

E-SKO300055	■	82
E-SKO400055	■	83
E-SKO450055	■	84
E-SKO500055	■	85
E-SKO600055	■	87
E-SKO700055	■	100
E-SKO800055	■	100
E-SKO900055	■	103
E-SKO1000055	■	107
E-SKO1200055	■	111



**drawer without front for carcass depth 70.5 cm**  
With cushioned self-closing mechanism and full pull-out  
Incl. guides

Ill. shows Legrabox pure Art

E-SKO300070		126
E-SKO400070		131
E-SKO450070		133
E-SKO500070		136
E-SKO600070		137
E-SKO700070		148
E-SKO800070		148
E-SKO900070		153
E-SKO1000070		156
E-SKO1200070		162



**Pull-out without front for carcass depths 34 cm, 45.5 cm and 55.5 cm**  
With cushioned self-closing mechanism and full pull-out  
Incl. guides

Ill. shows Legrabox pure Art

E-AZO300055	■	123
E-AZO400055	■	125
E-AZO450055	■	126
E-AZO500055	■	129
E-AZO600055	■	131
E-AZO700055	■	166
E-AZO800055	■	166
E-AZO900055	■	171
E-AZO1000055	■	173
E-AZO1200055	■	179



**Pull-out without front for carcass depth 70.5 cm**  
With cushioned self-closing mechanism and full pull-out  
Incl. guides

Ill. shows Legrabox free

E-AZO300070		188
E-AZO400070		191
E-AZO450070		192
E-AZO500070		193
E-AZO600070		194
E-AZO700070		210
E-AZO800070		210
E-AZO900070		213
E-AZO1000070		216
E-AZO1200070		224



**internal drawer**  
With cushioned self-closing mechanism and full pull-out Incl. guides

**Planning advice:**  
Take account of opening angle



Ill. shows Legrabox pure Art

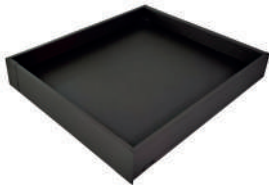
E-ISK300055	■	107
E-ISK400055	■	111
E-ISK450055	■	112
E-ISK500055	■	114
E-ISK600055	■	118
E-ISK700055	■	133
E-ISK800055	■	133
E-ISK900055	■	138
E-ISK1000055	■	144
E-ISK1200055	■	148

# Drawers / Pull-outs

■ = Models also available in 34/45.5/61 cm carcass depth (Order no.: ... replace ... 55 ... with 34/45/61)

Order no.

Price



**Internal drawer for 70.5 cm carcass depth**  
With cushioned self-closing mechanism and full pull-out

Ill. shows Legrabox pure Art

E-ISK300070	153
E-ISK400070	159
E-ISK450070	161
E-ISK500070	162
E-ISK600070	165
E-ISK700070	182
E-ISK800070	182
E-ISK900070	187
E-ISK1000070	193
E-ISK1200070	199



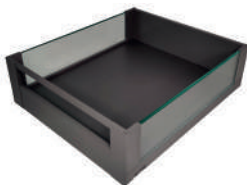
**Internal pull-out**  
With cushioned self-closing mechanism and full pull-out Incl. guides

**Planning advice:**  
Door with wide angle hinges  
Take account of opening angle



Ill. shows Legrabox pure Art

E-IAZ300055	■	154
E-IAZ400055	■	161
E-IAZ450055	■	163
E-IAZ500055	■	166
E-IAZ600055	■	171
E-IAZ700055	■	216
E-IAZ800055	■	216
E-IAZ900055	■	222
E-IAZ1000055	■	229
E-IAZ1200055	■	236



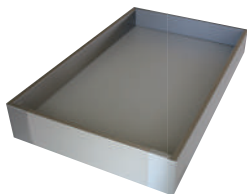
**Internal pull-out for 70.5 cm carcass depth**  
With cushioned self-closing mechanism and full pull-out

**Planning advice:**  
Door with wide angle hinges  
Take account of opening angle



Ill. shows Legrabox free

E-IAZ300070	227
E-IAZ400070	234
E-IAZ450070	236
E-IAZ500070	239
E-IAZ600070	245
E-IAZ700070	262
E-IAZ800070	262
E-IAZ900070	267
E-IAZ1000070	271
E-IAZ1200070	287



**internal drawer**  
With cushioned self-closing mechanism and full pull-out  
Incl. guides  
with 1 spacer strip to compensate for the hinge for installation behind doors for base and tall cabinets  
The width of the inner drawer is 2.5cm below the nominal size

E-ISK4555D	■	165
E-ISK5055D	■	167
E-ISK6055D	■	171

**Extra charge for 2 wide angle hinges 155 degrees**

SA90155E2	10,50
-----------	-------

**Extra charge for 3 wide angle hinges 155 degrees**

SA90155E3	17,10
-----------	-------



## Panels / stiles / pilasters

Panels 10 mm	XL 9.0.1
Panel shelves 10 mm	XL 9.0.1
Panels 16 mm	XL 9.0.2
Panel shelves 16 mm	XL 9.0.2
Accessories Panels 16 mm	XL 9.0.3
Panels 19 mm	XL 9.0.4
Panel shelves 19 mm	XL 9.0.4
Accessories Panels 19 mm	XL 9.0.5
Panels 25 mm	XL 9.0.6
Panel shelves 25 mm	XL 9.0.6
Accessories Panels 25 mm	XL 9.0.7
Panels 25 mm Canopies	XL 9.0.8
Push-fit shelves 25 mm	XL 9.0.8
Panels 25 mm profiled	XL 9.0.9-XL 9.0.10
Panels 50 mm	XL 9.0.10
Panel shelves 50 mm	XL 9.0.10-XL 9.0.11
Panels 50 mm front edge rounded	XL 9.0.11
Push-fit shelves 50 mm	XL 9.0.12
Panels 50 mm	XL 9.0.12
Accessories Panels 50 mm	XL 9.0.13
Variable shelf unit and panel system	XL 9.0.14
Sliding door system SlideLine M in conjunction with shelf unit and panel system	XL 9.0.15
Side panel	XL 9.0.16
Shelf	XL 9.0.16
Sliding doors for panel and shelf unit system SlideLine M	XL 9.0.16-XL 9.0.17
Stiles 100 mm	XL 9.0.19
Stile shelf 100 mm	XL 9.0.19
Push-fit shelves 100 mm	XL 9.0.20
Pilasters for country house elements	XL 9.0.21-XL 9.0.22
Plinth panels for country house elements	XL 9.0.23
Pilasters with moulded profile	XL 9.0.24-XL 9.0.25
Pilasters with moulded profile and lateral grooving	XL 9.0.26
Pilaster panel 100 mm	XL 9.0.27-XL 9.0.28
Pilasters Plinth panels	XL 9.0.29

## Technical information/recommendations - panels/stiles and end panel shelves/stile shelves

**Depth dimensions:**  
The exact dimensions of the panel/stile are calculated as follows:  
Carcase depth + 24 mm

Carcase depth	Panel/panel shelf depth +24 mm
339 mm	363 mm
455 mm	479 mm
555 mm	579 mm
575 mm	599 mm
605 mm	629 mm
610 mm	634 mm
705 mm	729 mm

**Depth dimensions:**  
The exact dimensions of the panel/stile are calculated as follows:  
Carcase depth + 24 mm

Carcase depth	Panel depths for island solutions +48 mm
339 mm + 455 mm	842 mm
339 mm + 555 mm	942 mm
339 mm + 610 mm	997 mm
455 mm + 455 mm	958 mm
455 mm + 555 mm	1058 mm
455 mm + 610 mm	1113 mm
555 mm + 555 mm	1158 mm
610 mm + 610 mm	1268 mm

Changes to the height dimensions for plans with panel protector depend on the plinth height

Panel thickness	WS16	WS19	WS25	WS50
Order panel protector	2 mm (WSCH 16)	8 mm (WSCH 19)	8 mm (WSCH 25)	8 mm (WSCH 50)
Plinth height	Panel height (+carc. height)	Panel height (+carc. height)	Panel height (+carc. height)	Panel height (+carc. height)
50 mm	48 mm	42 mm	42 mm	42 mm
75 mm	73 mm	67 mm	67 mm	67 mm
100 mm	98 mm	92 mm	92 mm	92 mm
125 mm	123 mm	117 mm	117 mm	117 mm
150 mm	148 mm	142 mm	142 mm	142 mm
175 mm	173 mm	167 mm	167 mm	167 mm
200 mm	198 mm	192 mm	192 mm	192 mm


### Example 1:

Base unit carcase height 780 mm / carcase depth 555 mm / panel thickness 25 mm / plinth height 100 mm  
The recommended panel dimensions are: height 872 mm (780 mm + 100 mm - 8 mm = 872 mm), depth 579 mm


### Example 2:

Tall unit carcase height 1560 mm / carcase depth 455 mm / panel thickness 16 mm / plinth height 50 mm  
The recommended panel dimensions are: height 1608 mm (1560 mm + 50 mm - 2 mm = 1608 mm), depth 479 mm

**Panels 10 mm**

		Order no. W H D	Hinge side: Carcase depth	Decor groups											
				M10	M20	M30	M40	M50	M60	M70	M80	M90			
<b>Panel 10 mm</b> edge on all sides X100X100mm	per m <sup>2</sup> , H x D														
	<b>WS 10</b>					432						793			
	<b>minimum price</b>					73						131			
		 <i>Maximum dimensions see section 2</i>													

**Panel shelves 10 mm**

		Order no. W H D	Hinge side: Carcase depth	Decor groups									
				M10	M20	M30	M40	M50	M60	M70	M80	M90	
<b>Panel shelf 10 mm</b> edge on all sides 100X100mm	pro m <sup>2</sup> , B x D												
	<b>WBS 10</b>							432				793	
	<b>minimum price</b>							73				131	
		 <i>Important!</i> <i>This material is not suitable for table tops!</i> <i>Maximum dimensions see section 2</i>											


10 mm Panels		M 10	M 20	M 30	M 40	M 50
						B10 M50 Velvet lacquer S10 M50 micro structured lacquer
		M 60	M 70	M 80	M 90	
				H10 M80 High Gloss Lack MP10 M80 Matt-Lacquer Premium		




**Spacer strip for planning between carcass and panel**  
 Thickness approx. 2 mm, length 2208 mm, natural-coloured.

		Order no. W H D	Hinge side: Carcase depth	Decor groups									
				M10	M20	M30	M40	M50	M60	M70	M80	M90	
<b>DLW</b>													
								7,20					

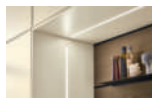

**Panels 16 mm**


		Hinge side:	Carcass depth	Decor groups								
Order no.				M10	M20	M30	M40	M50	M60	M70	M80	M90
W H D												
Panel 16 mm edge on all sidesX100X100mm	per m <sup>2</sup> , H x D											
	<b>WS 16</b>			84	143	324	432	432	432	612	793	173
	<b>minimum price</b>			47	50	73	74	74	121	134	134	96
		 <i>Maximum dimensions see section 2</i>										

**Panel shelves 16 mm**

Panel shelf 16 mm edge on all sides100XX100mm		pro m <sup>2</sup> , B x D										
		<b>WBS 16</b>		84	143	324	432	432	432	612	793	173
		<b>minimum price</b>		47	50	73	74	74	74	121	134	96
		 <i>Important!</i> <i>This material is not suitable for table tops!</i> <i>Maximum dimensions see section 2</i>										



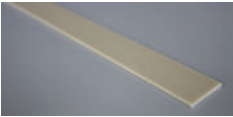








M 10	M 20	M 30	M 40	M 50
K16 M10 Laminate	D16 M20 Laminate decor	I16 M30 RESOPAL PRO super matt IH16 M30 HPL PRO PW16 M30 PRIMEWOOD/Basic Veneer	A16 M40 DIRECTLACK matt L16 M40 DIRECTLACK high-gloss	B16 M50 Velvet lacquer P16 M50 Soft lacquer, 16 mm R16H M50 Velvet lacquer wood texture R16W M50 Velvet lacquer spackle effect S16 M50 micro structured lacquer
M 60	M 70	M 80	M 90	
Q16H M60 SMARTGLAS high-gloss Q16M M60 SMARTGLAS satin-finish,	F16 M70 veneer / walnut / oak V16 M70 Velvet lacquer textured metallic Z16 M70 Veneer / Bavaria	C116 M80 FENIX stainless-steel look H16 M80 High gloss-Lacquer 16 mm MP16 M80 Matt-Lacquer Premium O16 M80 veneer	A116 M90 Worktop decor 16 mm	

 <p><b>LED light Manila IV „Emotion“</b>  <b>Lighting for panels and panel shelves (16, 19, 25, and 50 mm thick)</b>                      Homogeneous light, without visible light spots                      High-quality aluminium profile, stainless steel look                      Incl. end caps and assembly clips  <b>This product contains a light source of energy efficiency class F.</b></p>	per 10 cm Width											
	<b>LED-M4WS</b>			12.80								
	<b>minimum price</b>			25.60								
		 <i>Note: Article for VWSLED-M4 milling essential.</i> <i>Minimum clearance to edges 50 mm</i> <i>With milling up to 22.5 cm from the rear edge with cable hole, otherwise without cable hole</i> <i>Not possible in combination with other processing work (cutouts, angled cuts) on the panel or panel shelf.</i> <i>min. length 100 mm, max. length 2300 mm</i> <i>There is not a cable routing groove in the rear edge.</i>										


<p><b>Preparation for panels/panel shelves</b>  <b>For inset MANILA IV lights</b></p>	Unit price										
	<b>VWSLED-M4</b>			117							
	 <i>Note: minimum clearance to edges 50 mm</i> <b>An accurate dimensioned drawing is required for production!</b> <i>Please order lamps and converter separately</i>										




# Accessories Panels 16 mm

		Order no.	Price
	<p><b>Floor sealing band for panels</b>            Colour black            Length 650 mm, width 10 mm, thickness 3 mm</p>	<p> <i>Note: We recommend 2 floor sealing bands for panels from 50 mm thickness. For island panels, please consider the total depth of the panel.</i></p>	
		<b>BAB-W</b>	7,10
	<p><b>Spacer strip for planning between carcass and panel</b>            Thickness approx. 2 mm, length 2208 mm, natural-coloured.</p>		
		<b>DLW</b>	7,20
	<p><b>Cutout for 1 lamp fixture</b>            68 mm hole diameter</p>	<p> <i>Please order lamps and converter separately. An accurate dimensioned drawing is required for production!</i></p>	
1 milled cutout		<b>AFWSB-1</b>	77
2 cutouts		<b>AFWSB-2</b>	118
3 cutouts		<b>AFWSB-3</b>	156
	<p><b>Angled cut with edge</b></p>		
		<b>W-A</b>	53
	<p><b>Rounding with edge</b>            16mm: min outer radius = 40mm            19mm: min outer radius = 40mm            25mm: min outer radius = 25mm</p>		
		<b>W-R</b>	109
	<p><b>Corner cutout with edge</b>            (min. 10 cm deep)            16mm: min inside radius = 30mm            19mm: min inside radius = 30mm            25mm: min inside radius = 65mm</p>		
		<b>W-W</b>	109
	<p><b>Corner cutout with thin edge, 90° square</b></p>	<p> <i>Important! Minimum size 5 x 5 cm</i></p>	
		per 10 cm Width <b>W-WE 90</b>	25
	<p><b>Side panel protector for panel 16 mm</b>            Fixed dimension 125 cm with 2 end caps</p>	<p> <i>The fitting protrudes by 2 mm. Please take this into consideration when calculating the panel height</i></p>	
stainless steel-coloured		<b>WSCH 16</b>	19
black		<b>WSCH 16 S</b>	19



**Panels 19 mm**


		Order no. W H D	Hinge side: Carcase depth	Decor groups										
				M10	M20	M30	M40	M50	M60	M70	M80	M90		
<b>Panel 19 mm</b> edge on all sidesX100X100mm	per m <sup>2</sup> , H x D													
	<b>WS 19</b>													
	<b>minimum price</b>													
		 <i>Maximum dimensions see section 2</i>												

**Panel shelves 19 mm**



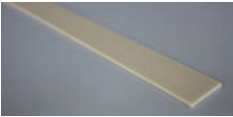








<b>Panel shelf 19 mm</b> edge on all sides100XX100mm	pro m <sup>2</sup> , B x D													
	<b>WBS 19</b>													
	<b>minimum price</b>													
		 <i>Important!</i> <i>This material is not suitable for table tops! Maximum dimensions see section 2</i>												

M 10	M 20	M 30	M 40	M 50
K19 M10 Laminate				B19 M50 Velvet lacquer S19 M50 micro structured lacquer
M 60	M 70	M 80	M 90	
	F19 M70 veneer / walnut / oak Z19 M70 Veneer / Bavaria	H19 M80 High gloss-Lacquer MP19 M80 Matt-Lacquer Premium		


 <p><b>LED light Manila IV „Emotion“</b>  <b>Lighting for panels and panel shelves (16, 19, 25, and 50 mm thick)</b>                      Homogeneous light, without visible light spots                      High-quality aluminium profile, stainless steel look                      Incl. end caps and assembly clips  <b>This product contains a light source of energy efficiency class F.</b></p>	per 10 cm Width												
	<b>LED-M4WS</b>												
	<b>minimum price</b>												
		 <i>Note: Article for VWSLED-M4 milling essential.</i> <i>Minimum clearance to edges 50 mm</i> <i>With milling up to 22.5 cm from the rear edge with cable hole, otherwise without cable hole</i> <i>Not possible in combination with other processing work (cutouts, angled cuts) on the panel or panel shelf.</i> <i>min. length 100 mm, max. length 2300 mm</i> <i>There is not a cable routing groove in the rear edge.</i>											

<b>Preparation for panels/panel shelves</b> <b>For inset MANILA IV lights</b>	Unit price													
	<b>VWSLED-M4</b>													
		 <i>Note: minimum clearance to edges 50 mm</i> <b>An accurate dimensioned drawing is required for production!</b> <i>Please order lamps and converter separately</i>												


# Accessories Panels 19 mm

		Order no.	Price
	<p><b>Floor sealing band for panels</b>            Colour black            Length 650 mm, width 10 mm, thickness 3 mm</p>	 <p><i>Note: We recommend 2 floor sealing bands for panels from 50 mm thickness. For island panels, please consider the total depth of the panel.</i></p>	
		<b>BAB-W</b>	7,10
	<p><b>Spacer strip for planning between carcass and panel</b>            Thickness approx. 2 mm, length 2208 mm, natural-coloured.</p>		
		<b>DLW</b>	7,20
	<p><b>Cutout for 1 lamp fixture</b>            68 mm hole diameter</p>	 <p><i>Please order lamps and converter separately            An accurate dimensioned drawing is required for production!</i></p>	
1 milled cutout		<b>AFWSB-1</b>	77
2 cutouts		<b>AFWSB-2</b>	118
3 cutouts		<b>AFWSB-3</b>	156
	<p><b>Angled cut with edge</b></p>		
		<b>W-A</b>	53
	<p><b>Rounding with edge</b>            16mm: min outer radius = 40mm            19mm: min outer radius = 40mm            25mm: min outer radius = 25mm</p>		
		<b>W-R</b>	109
	<p><b>Corner cutout with edge</b>            (min. 10 cm deep)            16mm: min inside radius = 30mm            19mm: min inside radius = 30mm            25mm: min inside radius = 65mm</p>		
		<b>W-W</b>	109
	<p><b>Corner cutout with thin edge, 90° square</b></p>	 <p><i>Important!            Minimum size 5 x 5 cm</i></p>	
		per 10 cm Width	
		<b>W-WE 90</b>	25
	<p><b>Side panel protector for panel 19 mm</b>            Fixed dimension 125 cm with 2 end caps</p>	 <p><i>The fitting protrudes by 8 mm. Please take this into consideration when calculating the panel height</i></p>	
stainless steel-coloured		<b>WSCH 19</b>	39
black		<b>WSCH 19 S</b>	39

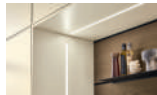

**Panels 25 mm**


	Order no. W H D	Hinge side: Carcase depth	Decor groups											
			M10	M20	M30	M40	M50	M60	M70	M80	M90			
<b>Panel 25 mm</b> edge on all sidesX100X100mm	per m <sup>2</sup> , H x D													
	<b>WS 25</b>		138	200	-	-	448	-	700	875	-			
	<b>minimum price</b>		52	75	-	-	86	-	139	156	-			
 <i>Maximum dimensions see section 2</i>														

**Panel shelves 25 mm**



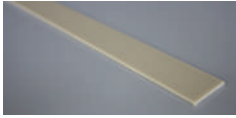


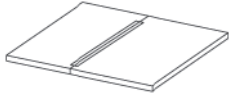
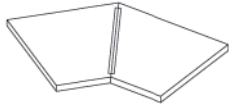
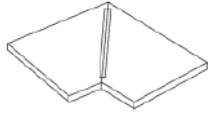






<b>Panel shelf 25 mm</b> edge on all sides100XX100mm	pro m <sup>2</sup> , B x D													
	<b>WBS 25</b>		138	200	-	-	448	-	700	875	-			
	<b>minimum price</b>		52	75	-	-	86	-	139	156	-			
 <i>Important!</i> <i>This material is not suitable for table tops!</i> <i>Maximum dimensions see section 2</i>														

M 10	M 20	M 30	M 40	M 50
K25 M10 Laminate 25 mm	D25 M20 Accessory decor 25 mm D149W Brown concrete effect D187W Concrete effect opal D188W Concrete effect pearl grey D212W graphite concrete effect			B25 M50 Velvet lacquer 25 mm S25 M50 micro structured lacquer
M 60	M 70	M 80	M 90	
	F25 M70 veneer / oak 25 mm Z25 M70 veneer / Bavaria 25 mm	ZH25 M80 High gloss-Lacquer 25 mm MP25 M80 Matt-Lacquer Premium O25 M80 Veneered 25 mm		





 <p><b>LED light Manila IV „Emotion“</b> <b>Lighting for panels and panel shelves (16, 19, 25, and 50 mm thick)</b> Homogeneous light, without visible light spots High-quality aluminium profile, stainless steel look Incl. end caps and assembly clips <b>This product contains a light source of energy efficiency class F.</b></p>	per 10 cm Width												
	<b>LED-M4WS</b>		12,80										
	<b>minimum price</b>		25,60										
 <i>Note: Article for VWSLED-M4 milling essential.</i> <i>Minimum clearance to edges 50 mm</i> <i>With milling up to 22.5 cm from the rear edge with cable hole, otherwise without cable hole</i> <i>Not possible in combination with other processing work (cutouts, angled cuts) on the panel or panel shelf.</i> <i>min. length 100 mm, max. length 2300 mm</i> <i>There is not a cable routing groove in the rear edge.</i>													

<b>Preparation for panels/panel shelves</b> <b>For inset MANILA IV lights</b>	Unit price													
	<b>VWSLED-M4</b>		117											
	 <i>Note: minimum clearance to edges 50 mm</i> <b>An accurate dimensioned drawing is required for production!</b> <i>Please order lamps and converter separately</i>													




# Accessories Panels 25 mm

		Order no.	Price
	<b>Floor sealing band for panels</b> Colour black Length 650 mm, width 10 mm, thickness 3 mm		<i>Note: We recommend 2 floor sealing bands for panels from 50 mm thickness. For island panels, please consider the total depth of the panel.</i>
		<b>BAB-W</b>	7,10
	<b>Spacer strip for planning between carcass and panel</b> Thickness approx. 2 mm, length 2208 mm, natural-coloured.		<b>DLW</b> 7,20
	<b>Cutout for 1 lamp fixture</b> 68 mm hole diameter		<i>Please order lamps and converter separately An accurate dimensioned drawing is required for production!</i>
	1 milled cutout	<b>AFWSB-1</b>	77
	2 cutouts	<b>AFWSB-2</b>	118
	3 cutouts	<b>AFWSB-3</b>	156
	Tongue and groove joint	<b>W-NF</b>	32
	Tongue and groove joint with 22.5° mitred cut as corner joint including angled cuts	<b>W-G225</b>	89
	Tongue and groove joint with 45° mitred cut as corner joint including angled cuts	<b>W-G45</b>	89
	<b>Angled cut with edge</b>	<b>W-A</b>	53
	<b>Rounding with edge</b> 16mm: min outer radius = 40mm 19mm: min outer radius = 40mm 25mm: min outer radius = 25mm	<b>W-R</b>	109
	<b>Corner cutout with edge</b> (min. 10 cm deep) 16mm: min inside radius = 30mm 19mm: min inside radius = 30mm 25mm: min inside radius = 65mm	<b>W-W</b>	109
	<b>Corner cutout with thin edge, 90° square</b>		<i>Important! Minimum size 5 x 5 cm</i>
		per 10 cm Width	<b>W-WE 90</b> 25
	<b>Corner cutout with edge, square</b>	Unit price	<b>W-WE 00</b> 25
	<b>Side panel protector for panel 25 mm</b> Fixed dimension 125 cm with 2 end caps  stainless steel-coloured black		<i>The fitting protrudes by 8 mm. Please take this into consideration when calculating the panel height</i>
		<b>WSCH 25</b>	24
		<b>WSCH 25 S</b>	24








## Panels 25 mm Canopies

		Order no.		Decor groups										
		W H D		Hinge side:	Carcass depth	M10	M20	M30	M40	M50	M60	M70	M80	M90
 <p><b>Canopy 25 mm,</b> 67.8 cm deep, 84.1 cm long with angled cuts for diagonal wall units 60 x 60 cm, connecting depth 36.5 cm</p>	Unit price													
	<b>WB 25 D 60 36</b>				186	269	-	-	523	-	523	523	-	
 <p><b>Canopy 25 mm,</b> 71.4 cm deep, 91.1 cm long with angled cuts for diagonal wall units 65 x 65 cm connecting depth 36.5 cm</p>	Unit price													
	<b>WB 25 D 65 36</b>				205	297	-	-	547	-	547	547	-	
 <p><b>Canopy 25 mm,</b> 89.3 cm deep, 96.6 cm long with angled cuts for diagonal wall units 60 x 60 cm, connecting depth 58 cm</p>	Unit price													
	<b>WB 25 D 60 58</b>				268	388	-	-	712	-	712	712	-	
 <p><b>Canopy 25 mm,</b> 92.9 cm deep, 103.7 cm long with angled cuts for diagonal wall units 65 x 65 cm connecting depth 58 cm</p>	Unit price													
	<b>WB 25 D 65 58</b>				276	400	-	-	734	-	734	734	-	
<b>M 10</b>	<b>M 20</b>	<b>M 30</b>	<b>M 40</b>	<b>M 50</b>										
K25 M10 Laminate 25 mm	D25 M20 Accessory decor 25 mm D149W Brown concrete effect D187W Concrete effect opal D188W Concrete effect pearl grey D212W graphite concrete effect				B25 M50 Velvet lacquer 25 mm S25 M50 micro structured lacquer									
<b>M 60</b>	<b>M 70</b>	<b>M 80</b>	<b>M 90</b>											
	F25 M70 veneer / oak 25 mm Z25 M70 veneer / Bavaria 25 mm	ZH25 M80 High gloss-Lacquer 25 mm MP25 M80 Matt-Lacquer Premium O25 M80 Veneered 25 mm												

## Push-fit shelves 25 mm

 <p><b>Push-fit shelf</b> 18 mm deep, 25 cm thick With concealed mounting fitting Max. length 260 cm, min. length 23 cm Available in all panel colours</p>	per 10 cm Width												
	<b>WSB 25 18</b>				9,60	14	-	-	19,20	-	22,80	29,60	-
 <p><b>Push-fit shelf</b> 25 mm deep, 25 cm thick With concealed mounting fitting Max. length 260 cm, min. length 23 cm Available in all panel colours</p>	per 10 cm Width												
	<b>WSB 25 25</b>				13,60	19,60	-	-	26,70	-	32	41	-
 <p><b>Bracketed shelf</b> 18 mm deep, 25 cm thick With concealed mounting fitting Max. length 260 cm, min. length 30 cm Number of supports: up to 100 cm: 2 up to 150 cm: 3 up to 200 cm: 4 up to 250 cm: 5</p>	per 10 cm Width												
	<b>KB-WSB25 18</b>				26	-	-	-	-	-	-	-	-
					130	-	-	-	-	-	-	-	
<b>M 10</b>	<b>M 20</b>	<b>M 30</b>	<b>M 40</b>	<b>M 50</b>									
K25 M10 Laminate 25 mm	D25 M20 Accessory decor 25 mm D149W Brown concrete effect D187W Concrete effect opal D188W Concrete effect pearl grey D212W graphite concrete effect				B25 M50 Velvet lacquer 25 mm S25 M50 micro structured lacquer								
<b>M 60</b>	<b>M 70</b>	<b>M 80</b>	<b>M 90</b>										
	F25 M70 veneer / oak 25 mm Z25 M70 veneer / Bavaria 25 mm	ZH25 M80 High gloss-Lacquer 25 mm MP25 M80 Matt-Lacquer Premium O25 M80 Veneered 25 mm											

# Panels 25 mm profiled

		Order no. W H D	Hinge side: Carcass depth	Decor groups										
				M10	M20	M30	M40	M50	M60	M70	M80	M90		
	<b>Panel shelf 25 mm</b> profiled on one side (front edge) up to 100 cm deep Max. length 250 cm	pro m <sup>2</sup> , B x D												
		<b>WBSL251</b> minimum price	-	-	-	-	639	-	-	-	-	-	-	-
	<b>Panel shelf 25 mm</b> profiled on 3 sides (front edge, left and right edge) up to 100 cm deep Max. length 250 cm	pro m <sup>2</sup> , B x D												
		<b>WBSL253</b> minimum price	-	-	-	-	639	-	-	-	-	-	-	-
	<b>Panel shelf 25 mm</b> profiled on all sides for free-standing configuration up to 100 cm deep Max. length 250 cm	pro m <sup>2</sup> , B x D												
		<b>WBSL254</b> minimum price	-	-	-	-	639	-	-	-	-	-	-	-
	<b>Push-fit shelf 18 cm deep, material thickness 2.5 cm</b> profiled on 3 sides With concealed mounting fitting max. length 250 cm, min. length 30 cm	per 10 cm Width												
		<b>WSBL 25 18</b> minimum price	-	-	-	-	21	-	-	-	-	-	-	-
	<b>Bracketed shelf 18 cm deep</b> 2.5 cm material thickness profiled on 3 sides With concealed mounting fitting Max. length 250 cm Min. length 30 cm Number of supports: up to 100 cm: 2 up to 150 cm: 3 up to 200 cm: 4 up to 250 cm: 5	per 10 cm Width												
		<b>KBSL 25 18</b> minimum price	-	-	-	-	37	-	-	-	-	-	-	-
	<b>Plinth trim panel</b> 2.5 cm material thickness profiled on one side (front edge) 7.5 cm deep Max. length 250 cm	per 10 cm Width												
		<b>SZBL257</b> minimum price	-	-	-	-	18	-	-	-	-	-	-	-
				 <b>Note:</b> Do not plan in conjunction with dishwasher and plinth return at unit side. <i>Planning advice:</i> Always allow for panels or pilasters at start and end of row.										
<b>M 10</b>	<b>M 20</b>	<b>M 30</b>	<b>M 40</b>	<b>M 50</b>										
Panels 25 mm				B25 M50 Velvet Lacquer 25 mm S25 M50 Microstructur lacquer 25 mm										
<b>M 60</b>	<b>M 70</b>	<b>M 80</b>	<b>M 90</b>											



## Panels 25 mm profiled

		Order no.	Decor groups										
		W H D	Hinge side:	Carcase depth	M10	M20	M30	M40	M50	M60	M70	M80	M90
	<b>Panel 25 mm</b> profiled on one side (front edge) max. 250 cm high max. 120 cm deep	per m <sup>2</sup> , H x D <b>WSL 25 1</b> minimum price			-	-	-	-	639	-	-	-	-
	<b>Panel 25 mm</b> profiled on 2 sides (front and rear edge) max. 250 cm high max. 120 cm deep	per m <sup>2</sup> , H x D <b>WSL 25 2</b> minimum price			-	-	-	-	639	-	-	-	-
	<b>Panel 25 mm</b> profiled on 3 sides (front and rear edge, bottom edge) max. 250 cm high max. 120 cm deep	per m <sup>2</sup> , H x D <b>WSL 25 3</b> minimum price			-	-	-	-	639	-	-	-	-
	<b>Panel 25 mm</b> profiled on all sides max. 250 cm high max. 120 cm deep	per m <sup>2</sup> , H x D <b>WSL 25 4</b> minimum price			-	-	-	-	639	-	-	-	-
<b>M 10</b>	<b>M 20</b>	<b>M 30</b>	<b>M 40</b>		<b>M 50</b>								
					B25 M50 Velvet Lacquer 25 mm S25 M50 Microstructur lacquer 25 mm								
<b>M 60</b>	<b>M 70</b>	<b>M 80</b>	<b>M 90</b>										

## Panels 50 mm

<b>Panel 50 mm</b> edge on all sides X250X100mm	per m <sup>2</sup> , H x D <b>WS 50</b> minimum price				332	-	-	-	546	-	738	1259	-
					61	-	-	-	98	-	156	171	-
<i>Maximum dimensions see section 2</i>													

## Panel shelves 50 mm

<b>Panel shelf 50 mm</b> edge on all sides 250XX100mm	pro m <sup>2</sup> , B x D <b>WBS 50</b> minimum price				332	-	-	-	546	-	738	1259	-
					61	-	-	-	98	-	156	171	-
<i>Important!</i> <i>This material is not suitable for table tops!</i> <i>Maximum dimensions see section 2</i>													

<b>M 10</b>	<b>M 20</b>	<b>M 30</b>	<b>M 40</b>	<b>M 50</b>
K50M10 Laminate K005S Castell Oak K023P Stainless Steel Colour K039G Premium white glossy K039P Premium white K043P Graphite Black K058P Magic-grey K075P Black K076P Macaron K160F Snow White K160G Snow White Gloss K178F White Agate K190S Mammoth oak natural K199S Piemont Oak K216S natural mountain oak K218P Light Pepper K229S Classic Oak K230P Art Pepper K235P Titan Steel K236S Diamond Oak effect K247S Dark Maron effect K248P Light Nude K262S Royal Oak effect K263P Fango K269S Mountain Wood K270S Elegant walnut effect				B50M50 Velvet lacquer S50M50 micro structured lacquer
<b>M 60</b>	<b>M 70</b>	<b>M 80</b>	<b>M 90</b>	
	F50M70 veneer / walnut / oak Z50M70 Veneer / Bavaria	H50M80 High gloss-Lacquer MP50M80 Matt-Lacquer Premium		

**Panel shelves 50 mm**

Decor groups									
M10	M20	M30	M40	M50	M60	M70	M80	M90	

Order no.  
W H D

Hinge side:  
Carcass depth

**LED light Manila IV „Emotion“**  
**Lighting for panels and panel shelves (16, 19, 25, and 50 mm thick)**  
 Homogeneous light, without visible light spots  
 High-quality aluminium profile, stainless steel look  
 Incl. end caps and assembly clips  
**This product contains a light source of energy efficiency class F.**



per 10 cm Width									
<b>LED-M4WS</b>									
<b>minimum price</b>									

**Note: Article for VWSLED-M4 milling essential.**  
 Minimum clearance to edges 50 mm  
 With milling up to 22.5 cm from the rear edge with cable hole, otherwise without cable hole  
 Not possible in combination with other processing work (cutouts, angled cuts) on the panel or panel shelf.  
 min. length 100 mm, max. length 2300 mm  
 There is not a cable routing groove in the rear edge.

**Preparation for panels/panel shelves**  
**For inset MANILA IV lights**

Unit price									
<b>VWSLED-M4</b>									
<b>minimum price</b>									

**Note: minimum clearance to edges 50 mm**  
**An accurate dimensioned drawing is required for production!**  
 Please order lamps and converter separately

**Panels 50 mm front edge rounded**

**Panel 50 mmX200X200mm**  
 Front edge and rear edge rounded,  
 painted on all sides



per m², H x D									
<b>WSRB 50</b>									
<b>minimum price</b>									

**Panel 50 mmX200X200mm**  
 Front edge rounded, painted on all sides

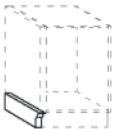
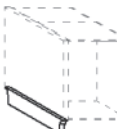
per m², H x D									
<b>WSRE 50</b>									
<b>minimum price</b>									

M 10	M 20	M 30	M 40	M 50
				B50M50 Samt-Lack S50M50 Mikrostruktur-Lack
M 60	M 70	M 80	M 90	
		H50M80 Hochglanz-Lack MP50M80 Matt-Lack Premium		








## Push-fit shelves 50 mm

		Order no. W H D		Hinge side:	Carcase depth	Decor groups								
						M10	M20	M30	M40	M50	M60	M70	M80	M90
	<b>Push-fit shelf</b> 18 mm deep, 50 cm thick With concealed mounting fitting Max. length 230 cm, min. length 23 cm	per 10 cm Width												
		<b>WSB 50 18</b> minimum price				20,60	-	-	-	26	-	35	38	-
						63	-	-	-	99	-	158	173	-
	<b>Push-fit shelf</b> 36.5 mm deep, 50 cm thick With concealed mounting fitting Max. length 230 cm, min. length 23 cm	per 10 cm Width												
		<b>WSB 50 36</b> minimum price				33	-	-	-	40	-	48	66	-
						103	-	-	-	140	-	195	228	-
M 10	M 20	M 30	M 40	M 50										
K50 M10 Laminate 50 mm K005S Castell Oak K023P Stainless Steel Colour K039G Premium white glossy K039P Premium white K043P Graphite Black K058P Magic-grey K075P Black K076P Macaron K160F Snow White K160G Snow White Gloss K178F White Agate K190S Mammoth oak natural K199S Piemont Oak K216S natural mountain oak K218P Light Pepper K229S Classic Oak K230P Art Pepper K235P Titan Steel K236S Diamond Oak effect K247S Dark Maron effect K248P Light Nude K262S Royal Oak effect K263P Fango K269S Mountain Wood K270S Elegant walnut effect				B50 M50 Velvet lacquer S50 M50 micro structured lacquer										
M 60	M 70	M 80	M 90											
	F50 M70 veneer / walnut / oak Z50 M70 Veneer / Bavaria	H50 M80 High gloss-Lacquer MP50 M80 Matt-Lacquer Premium												

## Panels 50 mm

	<b>Panel plinth 5 cm wide, 58 cm deep, profiled on one side</b>  10 cm high  as above, but 15 cm high  as above, but 20 cm high	Unit price													
		<b>PSW 10</b>								111	-	-	-	-	
		Unit price													
		<b>PSW 15</b>								128	-	-	-	-	
Extra charge for depths up to 120 cm		per 10 cm Width													
		<b>PSW-TV</b>								22,60					
	<b>Panel plinth 5 cm wide, up to 118 cm deep, profiled on both sides</b> for island solutions  10 cm high  as above, but 15 cm high  as above, but 20 cm high	Unit price													
		<b>PSWB 10</b>								155	-	-	-	-	
		Unit price													
		<b>PSWB 15</b>								200	-	-	-	-	
		Unit price													
		<b>PSWB 20</b>							269	-	-	-	-		
M 10	M 20	M 30	M 40	M 50											
Panels 50 mm				B50 M50 Velvet Lacquer 50 mm S50 M50 Microstructur lacquer 50 mm											
M 60	M 70	M 80	M 90												

# Accessories Panels 50 mm

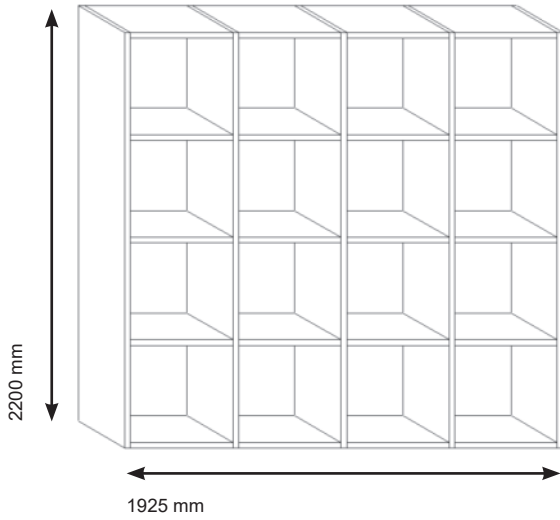
		Order no.	Price
	<b>Spacer strip for planning between carcass and panel</b> Thickness approx. 2 mm, length 2208 mm, natural-coloured.	<b>DLW</b>	7,20
	<b>Cutout for 1 lamp fixture</b> 68 mm hole diameter  1 milled cutout  2 cutouts  3 cutouts	 Please order lamps and converter separately <b>An accurate dimensioned drawing is required for production!</b>	77 118 156
	<b>Angled cut with edge</b>	<b>W-A</b>	53
	<b>Side panel protector for panel 50 mm</b> Fixed dimension 125 cm with 2 end caps  stainless steel-coloured  black	 The fitting protrudes by 8 mm. Please take this into consideration when calculating the panel height	33 33
	<b>Routed cutout for LED MANILA IV luminaire</b> in push-fit shelf 25 mm and 50 mm including slot for cable management at the rear Can be featured in conjunction with WSB 25 18, WSB 25 25 and WSB 50 18 floating shelves	 Please order lamps and converter separately <b>An accurate dimensioned drawing is required for production!</b> Each must be at least 7 mm from the edge 2 luminaires must be spaced apart by at least 50 mm Rear to centre slot at least 139 mm Front to centre slot at least 41 mm	117

# Variable shelf unit and panel system

The shelf unit and panel system offers maximum variability and flexibility. The width and height dimensions are variable, and available in a wide range of finishes. Perfect for adding comfortable accents to the kitchen!

The side panels and shelves are 2.5 cm thick. Side panels have no surface drillings. This means that the positions of the shelves can be chosen freely.

Connecting fittings are fitted to the undersides of the shelves. The counter-piece to the connecting fitting is to be mounted in the desired position on the side panel on site.

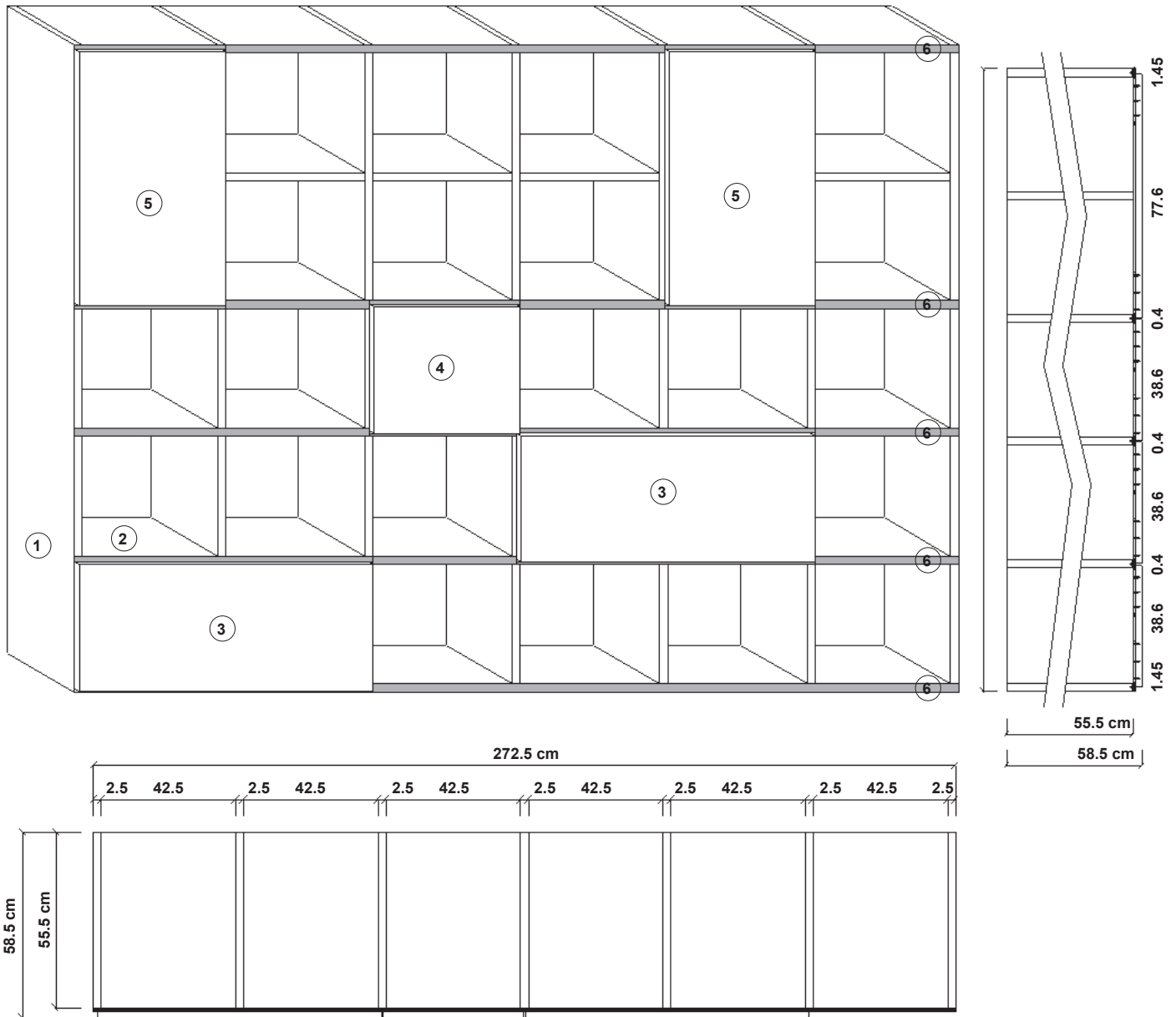


consisting of:

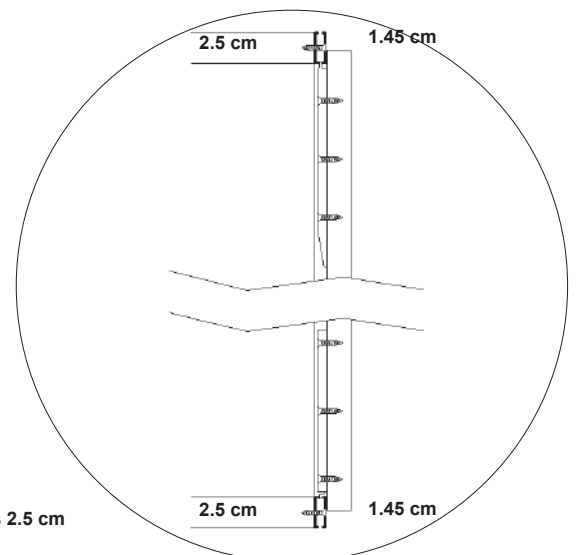
- 1x RWS-W 25 36 side panel 36.5 cm deep, height 220 cm
- 5x RWS-B 25 36 shelf 36.4 cm deep, width 45 cm
- 1x RWS-W 25 36 side panel 36.5 cm deep, height 220 cm
- 5x RWS-B 25 36 shelf 36.4 cm deep, width 45 cm
- 1x RWS-W 25 36 side panel 36.5 cm deep, height 220 cm
- 5x RWS-B 25 36 shelf 36.4 cm deep, width 45 cm
- 1x RWS-W 25 36 side panel 36.5 cm deep, height 220 cm
- 5x RWS-B 25 36 shelf 36.4 cm deep, width 45 cm
- 1x RWS-W 25 36 side panel 36.5 cm deep, height 220 cm






# Sliding door system SlideLine M in conjunction with shelf unit and panel system





- |   |  |  |
|---|--|--|
| ① | consisting of:<br>1x RWS-W 25 60   | side panel 55.5 cm deep, height 197.5 cm   |
| ② | 6x RWS-B 25 60<br>1x RWS-W 25 60<br>6x RWS-B 25 60<br>1x RWS-W 25 60<br>6x RWS-B 25 60<br>1x RWS-W 25 60<br>6x RWS-B 25 60<br>1x RWS-W 25 60<br>1x RWS-W 25 60<br>6x RWS-B 25 60<br>1x RWS-W 25 60<br>6x RWS-B 25 60<br>1x RWS-W 25 60 | shelf 55.4 cm deep, width 42.5 cm<br>side panel 55.5 cm deep, height 197.5 cm<br>shelf 55.4 cm deep, width 42.5 cm<br>side panel 55.5 cm deep, height 197.5 cm<br>shelf 55.4 cm deep, width 42.5 cm<br>side panel 55.5 cm deep, height 197.5 cm<br>shelf 55.4 cm deep, width 42.5 cm<br>side panel 55.5 cm deep, height 197.5 cm<br>shelf 55.4 cm deep, width 42.5 cm<br>side panel 55.5 cm deep, height 197.5 cm<br>shelf 55.4 cm deep, width 42.5 cm<br>side panel 55.5 cm deep, height 197.5 cm |
| ③ | 1x SLWF 90 39<br>1x SLWF 90 39   | sliding door 89.6 cm wide, height 38.6 cm<br>sliding door 89.6 cm wide, height 38.6 cm   |
| ④ | 1x SLWF 45 39  | sliding door 44.6 cm wide, height 38.6 cm  |
| ⑤ | 1x SLWF 45 78<br>1x SLWF 45 78   | sliding door 44.6 cm wide, height 77.6 cm<br>sliding door 44.6 cm wide, height 77.6 cm   |
| ⑥ | 3x SL-SET 25   | fittings for sliding doors profile set for shelf thickness 2.5 cm  |








## Side panel

		Order no. W H D	Hinge side:	Carcase depth	Decor groups								
					M10	M20	M30	M40	M50	M60	M70	M80	M90
 <p><b>Side panel 36.5 cm deep</b> 2.5 cm material thickness Variable in height, covered on both sides, edging finish on all sides with 2 concealed adjustment feet, max. 260 cm</p> <p>depth from 36.6 cm up to 60 cm</p>	 <p>Overall dimensions incl. adjustment feet Without drill holes for connecting fittings</p>												
		<b>RWS-W25 36</b>	9	14,30	-	-	19,60	-	24,80	-	-		
		<b>RWS-W25 60</b>	12,90	18,30	-	-	23,60	-	31	-	-		
<p><b>Panel 25 mm</b> edge on all sides</p>	 <p>Maximum dimensions see section 2</p>												
		<b>WS 25</b>	138	200	-	-	448	-	700	875	-		
<b>M 10</b> K25 M10 Laminate 25 mm	<b>M 20</b> D25 M20 Accessory decor 25 mm D149W Brown concrete effect D187W Concrete effect opal D188W Concrete effect pearl grey D212W graphite concrete effect	<b>M 30</b>	<b>M 40</b>		<b>M 50</b> B25 M50 Velvet lacquer 25 mm S25 M50 micro structured lacquer								
<b>M 60</b>	<b>M 70</b> F25 M70 veneer / oak 25 mm Z25 M70 veneer / Bavaria 25 mm	<b>M 80</b> ZH25 M80 High gloss-Lacquer 25 mm MP25 M80 Matt-Lacquer Premium O25 M80 Veneered 25 mm	<b>M 90</b>										

## Shelf






		Order no. W H D	Hinge side:	Carcase depth	Decor groups								
					M10	M20	M30	M40	M50	M60	M70	M80	M90
 <p><b>Shelf 36.4 cm deep</b> 2.5 cm material thickness variable in length up to 60 cm, minimum size 25 cm coated on both sides edging finish on all sides with 4 shelf connectors Finish metal</p> <p>depth from 36.5 cm up to 60 cm</p>	 <p>Shelves: depth 1 mm less than side panel</p>												
		<b>RWS-B25 36</b>	11,20	16,20	-	-	21,40	-	29,70	-	-		
		<b>RWS-B25 60</b>	15,20	21,80	-	-	25,40	-	36	-	-		
<b>M 10</b> K25 M10 Laminate 25 mm	<b>M 20</b> D25 M20 Accessory decor 25 mm D149W Brown concrete effect D187W Concrete effect opal D188W Concrete effect pearl grey D212W graphite concrete effect	<b>M 30</b>	<b>M 40</b>		<b>M 50</b> B25 M50 Velvet lacquer 25 mm S25 M50 micro structured lacquer								
<b>M 60</b>	<b>M 70</b> F25 M70 veneer / oak 25 mm Z25 M70 veneer / Bavaria 25 mm	<b>M 80</b> ZH25 M80 High gloss-Lacquer 25 mm MP25 M80 Matt-Lacquer Premium O25 M80 Veneered 25 mm	<b>M 90</b>										

## Sliding doors for panel and shelf unit system SlideLine M

		Order no. W H D	Hinge side:	Carcase depth	Price groups								
					1	2	3	4	5	6	7	8	9
 <p><b>Sliding door for panel and shelf unit system height 39 cm</b> 38.6 cm high complete with fittings clear height between 2 shelves 36.5 cm clear width between 2 panels: door width / . 21 mm</p>	<p><b>SLWF 45 39</b></p> <p><b>SLWF 50 39</b></p> <p><b>SLWF 60 39</b></p> <p><b>SLWF 80 39</b></p> <p><b>SLWF 90 39</b></p>		223	246	278	324	329	332	383	421	-		
			227	252	287	339	345	351	407	448	-		
			233	262	306	369	375	379	446	491	-		
			246	286	342	427	438	444	535	589	-		
			252	297	361	458	469	478	578	636	-		
 <p><b>Sliding door for panel and shelf unit system height 52 cm</b> 51.6 cm high complete with fittings clear height between 2 shelves 49.5 cm clear width between 2 panels: door width / . 21 mm</p>	<p><b>SLWF 45 52</b></p> <p><b>SLWF 50 52</b></p> <p><b>SLWF 60 52</b></p> <p><b>SLWF 80 52</b></p> <p><b>SLWF 90 52</b></p>		233	262	306	369	375	379	446	491	-		
			236	270	319	389	398	403	478	526	-		
			246	285	342	427	438	444	535	589	-		
			261	316	392	506	522	531	649	714	-		
			270	330	417	547	561	572	707	778	-		
		<p> <b>Not available for:</b> INTARSIA, MIAMI, VIVA</p>											
 <p><b>Sliding door for panel and shelf unit system height 65 cm</b> 64.6 cm high complete with fittings clear height between 2 shelves 62.5 cm clear width between 2 panels: door width / . 21 mm</p>	<p><b>SLWF 45 65</b></p> <p><b>SLWF 50 65</b></p> <p><b>SLWF 60 65</b></p> <p><b>SLWF 80 65</b></p> <p><b>SLWF 90 65</b></p>		242	280	332	414	422	427	513	564	-		
			249	288	349	438	446	455	548	603	-		
			258	308	377	488	499	507	621	683	-		
			279	346	441	586	603	615	764	840	-		
			290	365	473	638	654	667	837	921	-		
		<p> <b>Not available for:</b> INTARSIA, MIAMI, VIVA</p>											







# Sliding doors for panel and shelf unit system SlideLine M

		Price groups												
		Order no. W H D		Hinge side:	Carcass depth	1	2	3	4	5	6	7	8	9
776	 <p><b>Sliding door for panel and shelf unit system height 78 cm</b> 77.6 cm high complete with fittings clear height between 2 shelves 75.5 cm clear width between 2 panels: door width ./. 21 mm</p>	<b>SLWF 45 78</b>				252	297	361	458	469	478	578	636	-
		<b>SLWF 50 78</b>				258	308	377	488	499	507	621	683	-
		<b>SLWF 60 78</b>				270	330	417	547	561	572	707	778	-
		<b>SLWF 80 78</b>				297	375	491	666	685	700	879	967	-
		<b>SLWF 90 78</b>				308	400	528	726	747	764	966	1063	-
				<p> <b>Not available for:</b> ALUELEMENTS, ATLANTA-B, ATLANTA-S, BERGEN, CASTELLO, CHALET-B, CHALET-S, CHICAGO, FRAME, GENT, LUGANO, LUX-B, MIAMI, NOBEL-B, NOBEL-S, ORLANDO-B, ORLANDO-S, OSLO 15, PALERMO-B, PALERMO-S, ROMA-B, ROMA-S, SMART MIRROR, SOFIE-B, SOFIE-S, STRIP ELEMENTS, TESSIN 15, TIM 15, VILLAGE 15-B, VILLAGE 15-S, VINO, VIVA, YORK-B, YORK-S</p>										
906	 <p><b>Sliding door for panel and shelf unit system height 91 cm</b> 90.6 cm high complete with fittings clear height between 2 shelves 88.5 cm clear width between 2 panels: door width ./. 21 mm</p>	<b>SLWF 45 91</b>				261	314	390	501	516	525	642	706	-
		<b>SLWF 50 91</b>				269	326	411	537	550	561	692	761	-
		<b>SLWF 60 91</b>				283	354	453	607	623	638	792	871	-
		<b>SLWF 80 91</b>				312	408	540	745	769	784	992	1091	-
		<b>SLWF 90 91</b>				326	432	583	815	841	859	1094	1203	-
				<p> <b>Not available for:</b> ALUELEMENTS, ATLANTA-B, ATLANTA-S, BERGEN, CASTELLO, CHALET-B, CHALET-S, CHICAGO, FRAME, GENT, LUGANO, LUX-B, MIAMI, NOBEL-B, NOBEL-S, ORLANDO-B, ORLANDO-S, OSLO 15, PALERMO-B, PALERMO-S, ROMA-B, ROMA-S, SMART MIRROR, SOFIE-B, SOFIE-S, STRIP ELEMENTS, TESSIN 15, TIM 15, VILLAGE 15-B, VILLAGE 15-S, VINO, VIVA, YORK-B, YORK-S</p>										
 <p><b>Fittings for sliding doors profile set for shelf thickness 25 cm</b> complete with top and bottom runner profile (aluminium anodised) and aluminium decor profile for clipping 300 cm long, to be shortened on-site Incl. end caps and assembly clips Fixing screws</p>	<b>SL-SET25</b>				211									

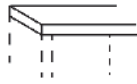




## Stiles 100 mm

This material is not suitable for table tops!

	Order no. W H D	per m <sup>2</sup> , H x D	Hinge side:	Carcase depth:	Decor groups														
					M10	M20	M30	M40	M50	M60	M70	M80	M90						
<b>Special size stiles 100 mm</b> K, D, C, C1, I, Q, B, S, R, F, V, Z: Front closed		per m <sup>2</sup> , H x D																	
		<b>STSV 100</b>	480	694	538	-	719	719	1024	1228	-								
		<b>minimum price</b>	201	201	298	-	302	430	579	579	-								
		 <b>Important!</b> Maximum dimensions see section 2 This material is not suitable for table tops!																	
<b>Special size stiles 100 mm</b> K, D, C, C1, I, Q, B, S, R, F, V, Z: Closed front and back		per m <sup>2</sup> , H x D																	
		<b>STSVH100</b>	543	757	601	-	781	781	1087	1304	-								
		<b>minimum price</b>	201	201	298	-	302	430	579	579	-								
		 <b>Important!</b> Maximum dimensions see section 2 This material is not suitable for table tops!																	
<b>Special size stiles 100 mm</b> K, D, C, C1, I, Q, B, S, R, F, V, Z: Front/top/bottom closed		per m <sup>2</sup> , H x D																	
		<b>STSVUO100</b>	543	757	601	-	781	781	1087	1304	-								
		<b>minimum price</b>	201	201	298	-	302	430	579	579	-								
		 <b>Important!</b> Maximum dimensions see section 2 This material is not suitable for table tops!																	
<b>Special size stiles 100 mm</b> K, D, C, C1, I, Q, B, S, R, F, V, Z, H, MP: Closed on all sides		per m <sup>2</sup> , H x D																	
		<b>STSA 100</b>	605	819	664	-	844	844	1149	1376	-								
		<b>minimum price</b>	201	201	298	-	302	430	579	579	-								
		 <b>Important!</b> Maximum dimensions see section 2 This material is not suitable for table tops!																	




## Stile shelf 100 mm

This material is not suitable for table tops!

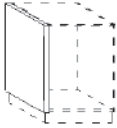
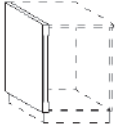
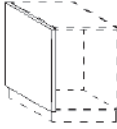
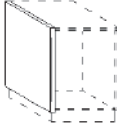
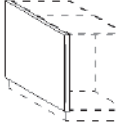
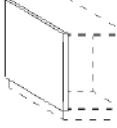
 <b>Special size stile shelf 100 mm</b> For horizontal configurations K, D, C, C1, I, Q: Front closed		pro m <sup>2</sup> , B x D																	
		<b>STBSV100</b>	480	694	538	-	-	719	-	1228	-								
		<b>minimum price</b>	201	201	298	-	-	430	-	579	-								
		 <b>Important!</b> Maximum dimensions see section 2 This material is not suitable for table tops!																	
<b>Special size stile shelf 100 mm</b> For horizontal configurations K, D, C, C1, I, Q: Closed front and back		pro m <sup>2</sup> , B x D																	
		<b>STBSVH100</b>	543	757	601	-	-	781	-	1304	-								
		<b>minimum price</b>	201	201	298	-	-	430	-	579	-								
		 <b>Important!</b> Maximum dimensions see section 2 This material is not suitable for table tops!																	
<b>Special size stile shelf 100 mm</b> For horizontal configurations K, D, C, C1, I, Q: Front/right/left side closed		pro m <sup>2</sup> , B x D																	
		<b>STBSVRL 100</b>	543	757	601	-	-	781	-	1304	-								
		<b>minimum price</b>	201	201	298	-	-	430	-	579	-								
		 <b>Important!</b> Maximum dimensions see section 2 This material is not suitable for table tops!																	
<b>Special size stile shelf 100 mm</b> For horizontal configurations K, D, C, C1, I, Q, B, S, R, F, V, Z, H, MP: Closed on all sides		pro m <sup>2</sup> , B x D																	
		<b>STBSA100</b>	605	819	664	-	844	844	1149	1376	-								
		<b>minimum price</b>	201	201	298	-	302	430	579	579	-								
		 <b>Important!</b> Maximum dimensions see section 2 This material is not suitable for table tops!																	

M 10	M 20	M 30	M 40	M 50
K M10 laminate	D M20 Laminate decor	I M30 RESOPAL PRO super matt IH M30 HPL PRO PW M30 PRIMEWOOD/Basic Veneer		B M50 Velvet lacquer RH M50 Velvet lacquer wood texture RW M50 Velvet lacquer spackle effect S M50 microstructure lacquer
M 60	M 70	M 80	M 90	
QH M60 SMARTGLAS high-gloss QM M60 SMARTGLAS satin-finish	F M70 veneer / oak / walnut V M70 Velvet lacquer textured Z M70 Veneer / Bavaria	C1 M80 FENIX stainless-steel look H M80 high gloss-Lacquer MP M80 laqué mat Premium		

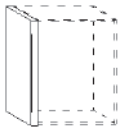


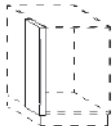
# Push-fit shelves 100 mm

				Decor groups															
				M10	M20	M30	M40	M50	M60	M70	M80	M90							
		Order no. W H D		Hinge side:	Carcase depth														
 <p><b>Push-fit shelf</b> 18 cm deep, 10 cm thick With concealed mounting fitting, Angular construction Max. length 260 cm, min. length 23 cm</p>	per 10 cm Width																		
	<b>WSBW100 18</b>																		
						41	-	-	-	-	-	-	-	-	-	-	-	-	-
						120	-	-	-	-	-	-	-	-	-	-	-	-	-
 <p><b>Push-fit shelf</b> 18 cm deep, 10 cm thick With concealed mounting fitting, at the sides Max. length 260 cm, min. length 23 cm</p>	per 10 cm Width																		
	<b>WSB 100 18</b>																		
						-	-	-	-	57	-	70	-	-	-	-	-	-	
						-	-	-	-	183	-	218	-	-	-	-	-	-	
<b>M 10</b>	<b>M 20</b>	<b>M 30</b>	<b>M 40</b>	<b>M 50</b>															
Push-fit shelf K100 M10 Laminate 100 mm				B100 M50 Velvet Lacquer 100 mm S100 M50 Micro struct. lacq. 100 mm															
<b>M 60</b>	<b>M 70</b>	<b>M 80</b>	<b>M 90</b>																
	F100 M70 veneer / oak 100 mm Z100 M70 veneer / Bavaria 100 mm																		
																			

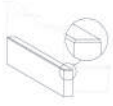
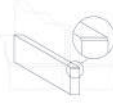
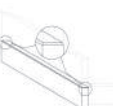
# Pilasters for country house elements

		Order no. W H D	Hinge side:	Carcass depth	Decor groups								
					M10	M20	M30	M40	M50	M60	M70	M80	M90
 <p><b>Pilaster panel for base unit</b> (profile with frieze) 5 cm wide, 58 cm deep</p>	71.5 cm high	<b>PFR 50 58 072</b>			-	-	-	-	267	-	-	-	-
	78 cm high	<b>PFR 50 58 078</b>			-	-	-	-	292	-	-	-	-
	84.5 cm high	<b>PFR 50 58 085</b>			-	-	-	-	300	-	-	-	-
 <p><b>Pilaster panel for base unit</b> (profile with frieze) suitable for configurations planned with a 2.5 cm panel shelf on the base units 5 cm wide, 58 cm deep</p>	74 cm high	<b>PFR 50 58 074</b>			-	-	-	-	276	-	-	-	-
	80.5 cm high	<b>PFR 50 58 080</b>			-	-	-	-	301	-	-	-	-
	87 cm high	<b>PFR 50 58 087</b>			-	-	-	-	310	-	-	-	-
 <p><b>Pilaster panel for base unit</b> (profile with frieze) 5 cm wide, 73 cm deep</p>	71.5 cm high	<b>PFR 50 73 072</b>			-	-	-	-	329	-	-	-	-
	78 cm high	<b>PFR 50 73 078</b>			-	-	-	-	361	-	-	-	-
	84.5 cm high	<b>PFR 50 73 085</b>			-	-	-	-	372	-	-	-	-
 <p><b>Pilaster panel for base unit</b> (profile with frieze) suitable for configurations planned with a 2.5 cm panel shelf on the base units 5 cm wide, 73 cm deep</p>	74 cm high	<b>PFR 50 73 074</b>			-	-	-	-	342	-	-	-	-
	80.5 cm high	<b>PFR 50 73 080</b>			-	-	-	-	371	-	-	-	-
	87 cm high	<b>PFR 50 73 087</b>			-	-	-	-	383	-	-	-	-
 <p><b>Pilaster panel for base unit</b> (profile with frieze) 5 cm wide, up to 118 cm deep with profile on both sides for island solutions</p>	71.5 cm high	<b>PFRB 50 00 072</b>			-	-	-	-	515	-	-	-	-
	78 cm high	<b>PFRB 50 00 078</b>			-	-	-	-	562	-	-	-	-
	84.5 cm high	<b>PFRB 50 00 085</b>			-	-	-	-	579	-	-	-	-
 <p><b>Pilaster panel for base unit</b> (profile with frieze) with profile on both sides for island solutions suitable for configurations planned with a 2.5 cm panel shelf on the base units 5 cm wide, up to 118 cm deep</p>	74 cm high	<b>PFRB 50 00 074</b>			-	-	-	-	533	-	-	-	-
	80.5 cm high	<b>PFRB 50 00 080</b>			-	-	-	-	580	-	-	-	-
	87 cm high	<b>PFRB 50 00 087</b>			-	-	-	-	597	-	-	-	-
<b>M 10</b>	<b>M 20</b>	<b>M 30</b>	<b>M 40</b>	<b>M 50</b>									
Pilaster				BL M50 Velvet Lacquer, Landhaus SL M50 Micro struct. lacq., Landhaus									
<b>M 60</b>	<b>M 70</b>	<b>M 80</b>	<b>M 90</b>										

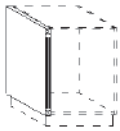
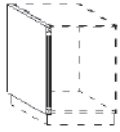
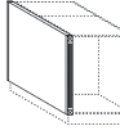
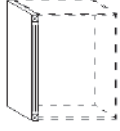
# Pilasters for country house elements

		Order no. W H D	Hinge side:	Carcase depth	Decor groups									
					M10	M20	M30	M40	M50	M60	M70	M80	M90	
 <p><b>Pilaster panel for wall units</b> (profile with frieze) 5 cm wide, 36.5 cm deep</p> <p>26 cm high 39 cm high 52 cm high 65 cm high 78 cm high 91 cm high</p>		PFR 50 36 026			-	-	-	-	96	-	-	-	-	
		PFR 50 36 039			-	-	-	-	144	-	-	-	-	
		PFR 50 36 052			-	-	-	-	179	-	-	-	-	
		PFR 50 36 065			-	-	-	-	192	-	-	-	-	
		PFR 50 36 078			-	-	-	-	215	-	-	-	-	
		PFR 50 36 091			-	-	-	-	239	-	-	-	-	
	 <p><b>Pilaster panel for dresser units</b> (profile with frieze) 5 cm wide, 36.5 cm deep</p> <p>113 cm high 119.5 cm high 126 cm high 132.5 cm high 139 cm high 145.5 cm high</p>		PFR 50 36 113			-	-	-	-	264	-	-	-	-
		PFR 50 36 119			-	-	-	-	279	-	-	-	-	
		PFR 50 36 126			-	-	-	-	298	-	-	-	-	
		PFR 50 36 132			-	-	-	-	311	-	-	-	-	
		PFR 50 36 139			-	-	-	-	321	-	-	-	-	
		PFR 50 36 145			-	-	-	-	334	-	-	-	-	
 <p><b>Pilaster panel for tall units</b> (profile with frieze) 5 cm wide, 58 cm deep</p> <p>143 cm high 156 cm high 168.8 cm high 181.8 cm high 194.8 cm high 207.8 cm high 220.8 cm high</p>			PFR 50 58 143			-	-	-	-	505	-	-	-	-
		PFR 50 58 156			-	-	-	-	553	-	-	-	-	
		PFR 50 58 169			-	-	-	-	598	-	-	-	-	
		PFR 50 58 182			-	-	-	-	629	-	-	-	-	
		PFR 50 58 195			-	-	-	-	675	-	-	-	-	
		PFR 50 58 208			-	-	-	-	719	-	-	-	-	
		PFR 50 58 221			-	-	-	-	764	-	-	-	-	
 <p><b>Pilaster panel for intermediate installation</b> (profile with frieze) 5 cm wide, 25 cm deep</p> <p>71.5 cm high 78 cm high 113 cm high 119.5 cm high 126 cm high 132.5 cm high 139 cm high 143 cm high 145.5 cm high 156 cm high 168.8 cm high 181.8 cm high 194.8 cm high 207.8 cm high 220.8 cm high</p>		PFR 50 25 072			-	-	-	-	181	-	-	-	-	
		PFR 50 25 078			-	-	-	-	196	-	-	-	-	
		PFR 50 25 113			-	-	-	-	214	-	-	-	-	
		PFR 50 25 119			-	-	-	-	227	-	-	-	-	
		PFR 50 25 126			-	-	-	-	227	-	-	-	-	
		PFR 50 25 132			-	-	-	-	237	-	-	-	-	
		PFR 50 25 139			-	-	-	-	251	-	-	-	-	
		PFR 50 25 143			-	-	-	-	257	-	-	-	-	
		PFR 50 25 145			-	-	-	-	261	-	-	-	-	
		PFR 50 25 156			-	-	-	-	271	-	-	-	-	
		PFR 50 25 169			-	-	-	-	279	-	-	-	-	
		PFR 50 25 182			-	-	-	-	294	-	-	-	-	
		PFR 50 25 195			-	-	-	-	314	-	-	-	-	
		PFR 50 25 208			-	-	-	-	328	-	-	-	-	
		PFR 50 25 221			-	-	-	-	351	-	-	-	-	
Pilaster	M 10	M 20	M 30	M 40	M 50		BL M50 Velvet Lacquer, Landhaus SL M50 Micro struct. lacq., Landhaus							
	M 60	M 70	M 80	M 90										

**Plinth panels for country house elements**


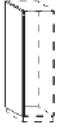

		Order no. W H D	Hinge side: Carcase depth	Decor groups									
				M10	M20	M30	M40	M50	M60	M70	M80	M90	
 <p><b>Pilaster base 5 cm wide</b> 58 cm deep profile with frieze on the front edge and on the outside, inside smooth</p>	10 cm high	Unit price <b>PSFR 10</b>	R/L	-	-	-	-	118	-	-	-	-	-
	15 cm high	Unit price <b>PSFR 15</b>	R/L	-	-	-	-	133	-	-	-	-	-
	20 cm high	Unit price <b>PSFR 20</b>	R/L	-	-	-	-	147	-	-	-	-	-
	Extra charge for depths up to 120 cm	<b>PSFR-TV</b>			38								
 <p><b>Pilaster base 5 cm wide</b> 58 cm deep profile with frieze on the front edge, Inside and outside smooth for intermediate installation pilaster panel</p>	10 cm high	Unit price <b>PSFRM10</b>		-	-	-	-	87	-	-	-	-	
	15 cm high	Unit price <b>PSFRM15</b>		-	-	-	-	101	-	-	-	-	
	20 cm high	Unit price <b>PSFRM20</b>		-	-	-	-	117	-	-	-	-	
	Extra charge for depths up to 120 cm	<b>PSFRM-TV</b>			23								
 <p><b>Pilaster base 5 cm wide</b> up to 118 cm deep profile with frieze on the front edge, rear edge and outside, inside smooth</p>	10 cm high	Unit price <b>PSFRB10</b>	R/L	-	-	-	-	147	-	-	-	-	
	15 cm high	Unit price <b>PSFRB15</b>	R/L	-	-	-	-	178	-	-	-	-	
	20 cm high	Unit price <b>PSFRB20</b>	R/L	-	-	-	-	209	-	-	-	-	
<b>M 10</b>	<b>M 20</b>	<b>M 30</b>	<b>M 40</b>	<b>M 50</b>									
Pilaster				B M50 Velvet Lacquer S M50 Microstructure Lacquer									
<b>M 60</b>	<b>M 70</b>	<b>M 80</b>	<b>M 90</b>										

# Pilasters with moulded profile

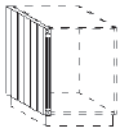
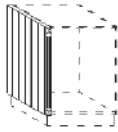
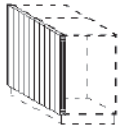
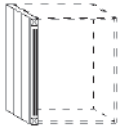
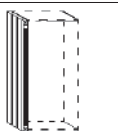
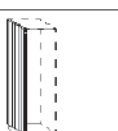
		Order no. W H D		Hinge side: Carcase depth		Decor groups									
						M10	M20	M30	M40	M50	M60	M70	M80	M90	
 <p><b>Pilaster panel base unit (moulded profile)</b> 5 cm wide, 58 cm deep</p> <p>65 cm high 71.5 cm high 78 cm high 84.5 cm high</p>															
		<b>PF 50 58 065</b>				199	-	-	-	280	-	367	-	603	
		<b>PF 50 58 072</b>				199	-	-	-	316	-	411	-	638	
		<b>PF 50 58 078</b>				199	-	-	-	319	-	414	-	671	
		<b>PF 50 58 085</b>				205	-	-	-	328	-	426	-	691	
 <p><b>Pilaster panel base unit (moulded profile)</b> 5 cm wide, 73 cm deep</p> <p>65 cm high 71.5 cm high 78 cm high 84.5 cm high</p>															
		<b>PF 50 73 065</b>				253	-	-	-	320	-	416	-	691	
		<b>PF 50 73 072</b>				253	-	-	-	356	-	464	-	735	
		<b>PF 50 73 078</b>				253	-	-	-	365	-	476	-	777	
		<b>PF 50 73 085</b>				261	-	-	-	375	-	490	-	800	
 <p><b>Pilaster panel base unit (moulded profile)</b> 5 cm wide, up to 118 cm deep with profile on both sides for island solutions</p> <p>65 cm high 71.5 cm high 78 cm high 84.5 cm high</p>															
		<b>PFB 50 00 065</b>				482	-	-	-	504	-	563	-	1218	
		<b>PFB 50 00 072</b>				482	-	-	-	519	-	643	-	1287	
		<b>PFB 50 00 078</b>				482	-	-	-	528	-	650	-	1356	
		<b>PFB 50 00 085</b>				496	-	-	-	545	-	669	-	1396	
 <p><b>Pilaster panel for wall unit (moulded profile)</b> 5 cm wide, 36.5 cm deep</p> <p>26 cm high 39 cm high 52 cm high 65 cm high 78 cm high 91 cm high</p>															
		<b>PF 50 36 026</b>				145	-	-	-	165	-	191	-	346	
		<b>PF 50 36 039</b>				145	-	-	-	172	-	227	-	389	
		<b>PF 50 36 052</b>				155	-	-	-	200	-	260	-	431	
		<b>PF 50 36 065</b>				155	-	-	-	240	-	314	-	474	
		<b>PF 50 36 078</b>				163	-	-	-	254	-	330	-	516	
		<b>PF 50 36 091</b>				171	-	-	-	279	-	366	-	558	
<b>M 10</b>	<b>M 20</b>	<b>M 30</b>	<b>M 40</b>	<b>M 50</b>											
Pilaster K M10 Laminate, Milled profile K076P Macaron				B M50 Velvet lacquer S M50 microstructure lacquer											
<b>M 60</b>	<b>M 70</b>	<b>M 80</b>	<b>M 90</b>												
	F M70 Veneer, Milled profile		U M90 Matt lacquer gold coloured app												



# Pilasters with moulded profile

				Decor groups												
				M10	M20	M30	M40	M50	M60	M70	M80	M90				
Order no. W H D				Hinge side:	Carcase depth:											
 <p><b>Pilaster panel for dresser unit (moulded profile)</b> 5 cm wide, 36.5 cm deep</p> <p>113 cm high 119.5 cm high 126 cm high 132.5 cm high 139 cm high 145.5 cm high</p>				PF	50	36	113	186	-	-	-	325	-	424	-	629
				PF	50	36	119	193	-	-	-	341	-	442	-	651
				PF	50	36	126	193	-	-	-	354	-	460	-	671
				PF	50	36	132	209	-	-	-	369	-	480	-	693
				PF	50	36	139	222	-	-	-	377	-	493	-	713
				PF	50	36	145	235	-	-	-	395	-	509	-	736
	 <p><b>Pilaster panel for tall unit (moulded profile)</b> 5 cm wide, 58 cm deep</p> <p>143 cm high 156 cm high 168.8 cm high 181.8 cm high 194.8 cm high 207.8 cm high 220.8 cm high</p>				PF	50	58	143	244	-	-	-	447	-	582	-
			PF	50	58	156	259	-	-	-	482	-	625	-	1080	
			PF	50	58	169	277	-	-	-	532	-	692	-	1147	
			PF	50	58	182	277	-	-	-	547	-	711	-	1217	
			PF	50	58	195	277	-	-	-	580	-	756	-	1283	
			PF	50	58	208	290	-	-	-	615	-	797	-	1352	
			PF	50	58	221	307	-	-	-	647	-	843	-	1419	
 <p><b>Pilaster panel for intermediate installation (moulded profile)</b> 5 cm wide, 25 cm deep</p> <p>65 cm high 71.5 cm high 78 cm high 113 cm high 126 cm high 139 cm high 143 cm high 156 cm high 168.8 cm high 181.8 cm high 194.8 cm high 207.8 cm high 220.8 cm high</p>					PF	50	25	065	137	-	-	-	149	-	199	-
				PF	50	25	072	137	-	-	-	149	-	210	-	423
				PF	50	25	078	137	-	-	-	153	-	217	-	438
				PF	50	25	113	141	-	-	-	206	-	264	-	517
				PF	50	25	126	144	-	-	-	218	-	286	-	547
				PF	50	25	139	146	-	-	-	233	-	302	-	577
				PF	50	25	143	146	-	-	-	236	-	307	-	585
				PF	50	25	156	163	-	-	-	252	-	325	-	615
				PF	50	25	169	182	-	-	-	268	-	351	-	644
				PF	50	25	182	187	-	-	-	279	-	365	-	674
				PF	50	25	195	187	-	-	-	294	-	379	-	702
				PF	50	25	208	193	-	-	-	308	-	400	-	732
				PF	50	25	221	211	-	-	-	321	-	419	-	762
	<b>M 10</b>		<b>M 20</b>		<b>M 30</b>		<b>M 40</b>		<b>M 50</b>							
Pilaster K M10 Laminate, Milled profile K076P Macaron								B M50 Velvet lacquer S M50 microstructure lacquer								
<b>M 60</b>		<b>M 70</b>		<b>M 80</b>		<b>M 90</b>										
		F M70 Veneer, Milled profile				U M90 Matt lacquer gold coloured app										

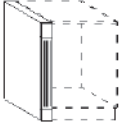

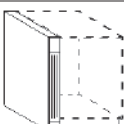

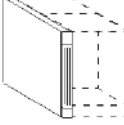

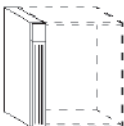



# Pilasters with moulded profile and lateral grooving

		Order no. W H D	Hinge side: Carcase depth	Decor groups									
				M10	M20	M30	M40	M50	M60	M70	M80	M90	
 <p><b>Pilaster panel for base unit (moulded profile, one side with vertical grooving)</b> 5 cm wide, 58 cm deep</p>	71.5 cm high	PFF 50 58 072	-	-	-	-	395	-	-	-	-		
	78 cm high	PFF 50 58 078	-	-	-	-	407	-	-	-	-		
	84.5 cm high	PFF 50 58 085	-	-	-	-	419	-	-	-	-		
 <p><b>Pilaster panel for base unit (moulded profile, one side with vertical grooving)</b> 5 cm wide, 73 cm deep</p>	71.5 cm high	PFF 50 73 072	-	-	-	-	485	-	-	-	-		
	78 cm high	PFF 50 73 078	-	-	-	-	496	-	-	-	-		
	84.5 cm high	PFF 50 73 085	-	-	-	-	511	-	-	-	-		
 <p><b>Pilaster panel for base unit (moulded profile, one side with vertical grooving)</b> 5 cm wide, up to 118 cm deep with profile on both sides, for island solutions</p>	71.5 cm high	PFFB 50 00 072	-	-	-	-	597	-	-	-	-		
	78 cm high	PFFB 50 00 078	-	-	-	-	610	-	-	-	-		
	84.5 cm high	PFFB 50 00 085	-	-	-	-	628	-	-	-	-		
 <p><b>Pilaster panel for wall unit (moulded profile, one side with vertical grooving)</b> 5 cm wide, 36.5 cm deep</p>	26 cm high	PFF 50 36 026	-	-	-	-	216	-	-	-	-		
	39 cm high	PFF 50 36 039	-	-	-	-	226	-	-	-	-		
	52 cm high	PFF 50 36 052	-	-	-	-	253	-	-	-	-		
	65 cm high	PFF 50 36 065	-	-	-	-	294	-	-	-	-		
	78 cm high	PFF 50 36 078	-	-	-	-	306	-	-	-	-		
	91 cm high	PFF 50 36 091	-	-	-	-	330	-	-	-	-		
 <p><b>Pilaster panel for dresser unit (moulded profile, one side with vertical grooving)</b> 5 cm wide, 36.5 cm deep</p>	113 cm high	PFF 50 36 113	-	-	-	-	406	-	-	-	-		
	119.5 cm high	PFF 50 36 119	-	-	-	-	419	-	-	-	-		
	126 cm high	PFF 50 36 126	-	-	-	-	431	-	-	-	-		
	132.5 cm high	PFF 50 36 132	-	-	-	-	446	-	-	-	-		
	139 cm high	PFF 50 36 139	-	-	-	-	458	-	-	-	-		
	145.5 cm high	PFF 50 36 145	-	-	-	-	473	-	-	-	-		
 <p><b>Pilaster panel for tall unit (moulded profile, one side with vertical grooving)</b> 5 cm wide, 58 cm deep</p>	143 cm high	PFF 50 58 143	-	-	-	-	566	-	-	-	-		
	156 cm high	PFF 50 58 156	-	-	-	-	598	-	-	-	-		
	168.8 cm high	PFF 50 58 169	-	-	-	-	649	-	-	-	-		
	181.8 cm high	PFF 50 58 182	-	-	-	-	664	-	-	-	-		
	194.8 cm high	PFF 50 58 195	-	-	-	-	699	-	-	-	-		
	207.8 cm high	PFF 50 58 208	-	-	-	-	731	-	-	-	-		
	220.8 cm high	PFF 50 58 221	-	-	-	-	764	-	-	-	-		
<b>M 10</b>		<b>M 20</b>		<b>M 30</b>		<b>M 40</b>		<b>M 50</b>					
Pilaster								BR M50 Velvet lacquer, milled grooves SR M50 Microtxtrd lac/milled grooves					
<b>M 60</b>		<b>M 70</b>		<b>M 80</b>		<b>M 90</b>							

# Pilaster panel 100 mm



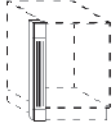





Order no.  
W H D

Hinge side:	Carcase depth	Decor groups								
		M10	M20	M30	M40	M50	M60	M70	M80	M90

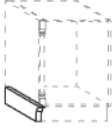

 <p><b>Pilaster panel for base unit</b> Front with grooving can be used left and right, rear closed Upper lines at 13 cm Lower lines, bottom edge carcase width 10 cm, depth 58 cm With height adjustment  Suitable for carcase height 65 cm Suitable for carcase height 71.5 cm Suitable for carcase height 78 cm Suitable for carcase height 84.5 cm</p>	 <p>The overall height of the pilaster panel is calculated from the plinth height and carcase height.</p>										
		PFU 100 58 065	-	-	-	-	482	-	-	-	1206
		PFU 100 58 072	-	-	-	-	531	-	-	-	1257
		PFU 100 58 078	-	-	-	-	579	-	-	-	1310
		PFU 100 58 085	-	-	-	-	596	-	-	-	1348
 <p><b>Pilaster panel for base unit</b> <b>As above, but 73 cm depth</b>  Suitable for carcase height 65 cm Suitable for carcase height 71.5 cm Suitable for carcase height 78 cm Suitable for carcase height 84.5 cm</p>	 <p>The overall height is made up of the carcase height and plinth height.</p>										
		PFU 100 73 065	-	-	-	-	606	-	-	-	1340
		PFU 100 73 072	-	-	-	-	633	-	-	-	1405
		PFU 100 73 078	-	-	-	-	690	-	-	-	1470
		PFU 100 73 085	-	-	-	-	710	-	-	-	1513
 <p><b>Pilaster panel for base unit</b> with profile on both sides, for island solutions Front with grooving Can be used left and right Upper lines at 13 cm Lower lines, bottom edge carcase width 10 cm, depth up to 118 cm With height adjustment  Suitable for carcase height 65 cm Suitable for carcase height 71.5 cm Suitable for carcase height 78 cm Suitable for carcase height 84.5 cm</p>	 <p>The overall height is made up of the carcase height and plinth height.</p>										
		PFBU100 00 065	-	-	-	-	1272	-	-	-	2430
		PFBU100 00 072	-	-	-	-	1398	-	-	-	2536
		PFBU100 00 078	-	-	-	-	1525	-	-	-	2640
		PFBU100 00 085	-	-	-	-	1571	-	-	-	2721
 <p><b>Pilaster panel for wall units</b> Front with grooving can be used left and right, rear closed Upper lines at 13 cm width 10 cm, depth 36.5 cm  Suitable for carcase height 65 cm Suitable for carcase height 78 cm Suitable for carcase height 91 cm</p>	 <p>The overall height is made up of the carcase height and plinth height.</p>										
		PFH 100 36 065	-	-	-	-	302	-	-	-	1014
		PFH 100 36 078	-	-	-	-	332	-	-	-	1046
		PFH 100 36 091	-	-	-	-	364	-	-	-	1079
 <p><b>Pilaster panel for dresser units</b> Front with grooving can be used left and right, rear closed Upper lines at 13 cm width 10 cm, depth 36.5 cm  Suitable for carcase height 113 cm Suitable for carcase height 119.5 cm Suitable for carcase height 126 cm Suitable for carcase height 132.5 cm Suitable for carcase height 139 cm Suitable for carcase height 145.5 cm</p>	 <p>The overall height is made up of the carcase height and plinth height.</p>										
		PFA 100 36 113	-	-	-	-	478	-	-	-	1255
		PFA 100 36 119	-	-	-	-	502	-	-	-	1288
		PFA 100 36 126	-	-	-	-	532	-	-	-	1321
		PFA 100 36 132	-	-	-	-	559	-	-	-	1352
		PFA 100 36 139	-	-	-	-	566	-	-	-	1385
		PFA 100 36 145	-	-	-	-	579	-	-	-	1416

M 10	M 20	M 30	M 40	M 50
Pilaster				BR M50 Velvet lacquer, milled grooves SR M50 Microtxtrd lac/milled grooves
M 60	M 70	M 80	M 90	
			UR M90 Matt lacquer gold coloured app	

# Pilaster panel 100 mm

		Decor groups										
		M10	M20	M30	M40	M50	M60	M70	M80	M90		
Order no. W H D		Hinge side:	Carcase depth:									
 <p><b>Pilaster panel for tall units</b>                      Front with grooving                      can be used left and right,                      rear closed                      Upper lines at 13 cm                      Lower lines, bottom edge carcass                      width 10 cm, depth 58 cm                      With height adjustment                      Suitable for carcass height 143 cm                      Suitable for carcass height 156 cm                      Suitable for carcass height 168.8 cm                      Suitable for carcass height 181.8 cm                      Suitable for carcass height 194.8 cm                      Suitable for carcass height 207.8 cm                      Suitable for carcass height 220.8 cm</p>	 The overall height is made up of the carcass height and plinth height.											
		PFG 100 58 143	-	-	-	-	1002	-	-	-	1827	
		PFG 100 58 156	-	-	-	-	1091	-	-	-	1929	
		PFG 100 58 169	-	-	-	-	1182	-	-	-	2034	
		PFG 100 58 182	-	-	-	-	1237	-	-	-	2135	
		PFG 100 58 195	-	-	-	-	1327	-	-	-	2241	
		PFG 100 58 208	-	-	-	-	1414	-	-	-	2343	
		PFG 100 58 221	-	-	-	-	1503	-	-	-	2446	
 <p><b>Pilaster panel for intermediate installation For base units</b>                      Front with grooving                      width 10 cm, depth 10 cm                      Upper lines at 13 cm                      Lower lines, bottom edge carcass                      width 10 cm, depth 10 cm                      With height adjustment                      Suitable for carcass height 65 cm                      Suitable for carcass height 71.5 cm                      Suitable for carcass height 78 cm                      Suitable for carcass height 84.5 cm</p>	 The overall height is made up of the carcass height and plinth height.											
		PFU 100 10 065	-	-	-	-	207	-	-	-	911	
		PFU 100 10 072	-	-	-	-	228	-	-	-	933	
		PFU 100 10 078	-	-	-	-	250	-	-	-	956	
		PFU 100 10 085	-	-	-	-	258	-	-	-	985	
 <p><b>Pilaster panel for intermediate installation for dresser units</b>                      Front with grooving                      can be used left and right,                      rear closed                      Upper lines at 13 cm                      width 10 cm, depth 10 cm                      Suitable for carcass height 113 cm                      Suitable for carcass height 119.5 cm                      Suitable for carcass height 126 cm                      Suitable for carcass height 132.5 cm                      Suitable for carcass height 139 cm                      Suitable for carcass height 145.5 cm</p>	 The overall height is made up of the carcass height and plinth height.											
		PFA 100 10 113	-	-	-	-	361	-	-	-	1075	
		PFA 100 10 119	-	-	-	-	379	-	-	-	1098	
		PFA 100 10 126	-	-	-	-	402	-	-	-	1120	
		PFA 100 10 132	-	-	-	-	422	-	-	-	1143	
		PFA 100 10 139	-	-	-	-	442	-	-	-	1166	
		PFA 100 10 145	-	-	-	-	465	-	-	-	1188	
 <p><b>Pilaster panel for intermediate installation for tall units</b>                      Front with grooving                      can be used left and right,                      rear closed                      Upper lines at 13 cm                      Lower lines, bottom edge carcass                      width 10 cm, depth 10 cm                      With height adjustment                      Suitable for carcass height 143 cm                      Suitable for carcass height 156 cm                      Suitable for carcass height 168.8 cm                      Suitable for carcass height 181.8 cm                      Suitable for carcass height 194.8 cm                      Suitable for carcass height 207.8 cm                      Suitable for carcass height 220.8 cm</p>	 The overall height is made up of the carcass height and plinth height.											
		PFG 100 10 143	-	-	-	-	458	-	-	-	1179	
		PFG 100 10 156	-	-	-	-	498	-	-	-	1223	
		PFG 100 10 169	-	-	-	-	540	-	-	-	1269	
		PFG 100 10 182	-	-	-	-	581	-	-	-	1313	
		PFG 100 10 195	-	-	-	-	623	-	-	-	1356	
		PFG 100 10 208	-	-	-	-	629	-	-	-	1401	
		PFG 100 10 221	-	-	-	-	668	-	-	-	1445	
		<b>M 10</b>	<b>M 20</b>	<b>M 30</b>	<b>M 40</b>	<b>M 50</b>						
Pilaster				BR M50 Velvet lacquer, milled grooves SR M50 Microbtrd lac/milled grooves								
<b>M 60</b>	<b>M 70</b>	<b>M 80</b>	<b>M 90</b>									
			UR M90 Matt lacquer gold coloured app									

# Pilasters Plinth panels

		Order no. W H D		Decor groups																			
				Hinge side:	Carcase depth	M10	M20	M30	M40	M50	M60	M70	M80	M90									
 <p><b>Pilaster base 5 cm wide</b> 56 cm deep, profiled on one side</p>	10 cm high	Unit price																					
		<b>PS 10</b>																					
	15 cm high	Unit price																					
		<b>PS 15</b>																					
	20 cm high	Unit price																					
	<b>PS 20</b>																						
Extra charge for depths up to 120 cm		per 10 cm Width																					
		<b>PS-TV</b>																					
 <p><b>Pilaster base 5 cm wide</b> up to 180 cm deep, profiled on both sides for island solutions</p>	10 cm high	Unit price																					
		<b>PSB 10</b>																					
	15 cm high	Unit price																					
		<b>PSB 15</b>																					
	20 cm high	Unit price																					
		<b>PSB 20</b>																					
<b>M 10</b>	<b>M 20</b>	<b>M 30</b>	<b>M 40</b>	<b>M 50</b>																			
Pilaster K M10 laminate					B M50 Velvet Lacquer S M50 Microstructure Lacquer																		
<b>M 60</b>	<b>M 70</b>	<b>M 80</b>	<b>M 90</b>																				
	F M70 veneer / oak / walnut				U M90 Matt lacquer gold coloured app																		

# 10

## Cornices, light pelmets

Cornices KL 104	XL 10.0.1
Cornices KL 105	XL 10.0.1
Light pelmets LB 101	XL 10.0.3
Light pelmets LB 102	XL 10.0.3


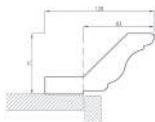




# Cornices KL 104


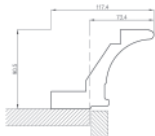
Hinge side:	Carcase depth	Decor groups								
		M10	M20	M30	M40	M50	M60	M70	M80	M90

Order no.  
W H D

<p><b>Cornice KL 104</b></p>  <p>Including mitre cuts</p>  <p>Decor group S, B standard length 360 cm (not cut to size)</p>	<p><b>Note:</b> Decor groups S/B: only available with glued outside mitre joints. Take account of item MP-AGV for each glued outside mitre joint.</p>								
	per 10 cm Width								
	<b>KL 104</b>	-	-	-	-	24	-	-	-
Unit price									
<b>KL 104 S</b>	-	-	-	-	463	-	-	-	-






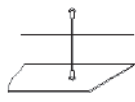
M 50	M 50	M 80	M 80	M 90
<p><b>KL4B M50 KL104 Velvet lacquer</b></p> <p>B006F Light Grey B039F Premium white B043F Graphite Black B058F Magic-grey B075F Black B076F Macaron B099F special colour B160F Snow White B169F Dolphin Grey B178F White Agate B218F Light Pepper B230F Art Pepper B245F Night Green B248F Light Nude B263F Fango</p>	<p><b>KL4S M50 KL104 micro structured lacquer</b></p> <p>S006P Light Grey S039P Premium white S043P Graphite Black S058P Magic-grey S075P Black S076P Macaron S099P special colour S160P Snow White S169P Dolphin Grey S178P White Agate S218P Light Pepper S230P Art Pepper S245P Night Green S248P Light Nude S263P Fango</p>			

# Cornices KL 105

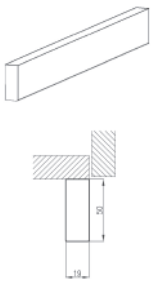

<p><b>Cornice KL 105</b></p>  <p>Including mitre cuts</p>  <p>Standard length 360 cm (not cut to size)</p>	<p><b>Note:</b> Only available with glued outside mitre joints. Take account of item MP-AGV for each glued outside mitre joint.</p>								
	per 10 cm Width								
	<b>KL 105</b>	-	-	-	-	27	-	-	48
Unit price									
<b>KL 105 S</b>	-	-	-	-	588	-	-	1486	1486

M 50	M 50	M 80	M 80	M 90
<p><b>KL5B M50 KL105 Velvet lacquer</b></p> <p>B006F Light Grey B039F Premium white B043F Graphite Black B058F Magic-grey B075F Black B076F Macaron B099F special colour B160F Snow White B169F Dolphin Grey B178F White Agate B218F Light Pepper B230F Art Pepper B245F Night Green B248F Light Nude B263F Fango</p>	<p><b>KL5S M50 KL105 micro structured lacquer</b></p> <p>S006P Light Grey S039P Premium white S043P Graphite Black S058P Magic-grey S075P Black S076P Macaron S099P special colour S160P Snow White S169P Dolphin Grey S178P White Agate S218P Light Pepper S230P Art Pepper S245P Night Green S248P Light Nude S263P Fango</p>	<p><b>KL5H M80 KL105 High gloss lacquer</b></p> <p>H006H Light Grey H039H Premium white H043H Graphite Black H058H Magic-grey H075H Black H076H Macaron H099H special colour H160H Snow White H169H Dolphin Grey H178H White Agate H218H Light Pepper H230H Art Pepper H245H Night Green H263H Fango</p>	<p><b>KL5MP M80 KL105 Matt lacquer Premium</b></p> <p>MP006 Light Grey MP039 Premium white MP043 Graphite Black MP058 Magic-grey MP075 Black MP076 Macaron MP099 special colour MP160 Snow White MP169 Dolphin Grey MP178 White Agate MP218 Light Pepper MP230 Art Pepper MP245 Night Green MP248 Light Nude MP263 Fango</p>	<p><b>KL5U M90 KL105 Matt lacquer gold applic</b></p> <p>U039M Premium White/gold-coloured</p>

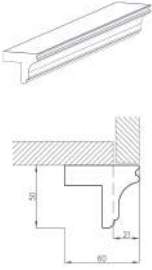

# Bridging shelves

		Order no.	Decor groups								
			M10	M20	M30	M40	M50	M60	M70	M80	M90
		W H D									
 <p><b>Bridging shelf</b> (can also be used as an intermediate shelf) for door and window superstructures 16 mm thick, 35 cm deep (1 cm extra depth for adaptation on-site). thin edge on all sides</p>	per 10 cm Width										
	<p><b>Z 21 BUE</b> minimum price</p> <p> <i>K max. 260 cm D max. 260 cm S/B/J max. 230 cm F max. 250 cm H max. 230 cm M max. 230 cm</i></p>	6,60	8,20	-	-	22,80	-	22,80	22,80	-	
			46	46	-	-	46	-	46	46	-
<p><b>Bridging shelf as above, but 56.5 cm depth</b></p>	per 10 cm Width										
	<p><b>Z 21 BUET</b> minimum price</p> <p> <i>K max. 260 cm D max. 260 cm S/B/J max. 230 cm F max. 250 cm H max. 230 cm M max. 230 cm</i></p>	8,20	9,60	-	-	37	-	37	37	-	
			47	47	-	-	47	-	47	47	-
<p><b>Bridging shelf as intermediate shelf</b> for door and window superstructures 16 mm thick, 35 cm deep (1 cm extra depth for adaptation on-site). Thick edge on all sides</p>	per 10 cm Width										
	<p><b>Z 21 BUEZ</b> minimum price</p> <p> <i>K max. 260 cm D max. 260 cm S/B/J max. 230 cm F max. 250 cm H max. 230 cm M max. 230 cm</i></p>	6,60	8,20	-	-	22,80	-	22,80	22,80	-	
			46	46	-	-	46	-	46	46	-
<p><b>Bridging shelf as above, but 56.5 cm depth</b></p>	per 10 cm Width										
	<p><b>Z 21 BUETZ</b> minimum price</p> <p> <i>K max. 260 cm D max. 260 cm S/B/J max. 230 cm F max. 250 cm H max. 230 cm M max. 230 cm</i></p>	8,20	9,60	-	-	37	-	37	37	-	
			47	47	-	-	47	-	47	47	-
<b>M 10</b>	<b>M 20</b>	<b>M 30</b>	<b>M 40</b>		<b>M 50</b>						
K M10 laminate	D M20 Laminate decor				B M50 Velvet lacquer S M50 microstructure lacquer						
<b>M 60</b>	<b>M 70</b>	<b>M 80</b>	<b>M 90</b>								
	F M70 veneer / oak / walnut Z M70 Veneer / Bavaria	H M80 high gloss-Lacquer MP M80 laqué mat Premium									
<p><b>Extra charge for fixed cornice installation (cornice with rebate for surface mounted installation of the door and window superstructure)</b></p>	per 10 cm Width										
	<p><b>Z 21 BUE-KL</b></p>	2,80									
<p><b>Extra charge for angled cuts on door and window superstructures</b></p>	Unit price										
	<p><b>Z 21 BUE-AWA</b></p>	53									
<p><b>Extra charge for corner cutouts on door and window superstructures</b></p>	Unit price										
	<p><b>Z 21 BUE-AWW</b></p>	109									
 <p><b>Suspension cable for canopies</b> stainless steel-coloured 100cm long, price per item</p>	Unit price										
	<p><b>Z 81</b></p>	52									
<p><b>Extra charge for each glued outside mitre joint</b> for cornices and light pelmets micro textured lacquer, velvet lacquer, matt lacquer, dabbed lacquer and high-gloss lacquer</p>	<b>MP-AGV</b>	66									

# Light pelmets LB 101

		Order no. W H D		Hinge side:	Carcass depth	Decor groups									
						M10	M20	M30	M40	M50	M60	M70	M80	M90	
<b>Light pelmet</b>  <p>Including mitre cuts</p> <p>Extra charge rear lacquer</p> <p>Standard length 260 - 360 cm (not cut to size)</p>	 <b>Note:</b> Decor groups S/B/H/F/M: only available with glued outside mitre joints. Take account of item MP-AGV for each glued outside mitre joint. K = 260 cm		per 10 cm Width												
	<b>LB 101</b>		5,20	-	-	-	11,90	-	-	16,70	16,70				
	<b>MP-RLB101</b>		-	-	-	-	2,80	-	-	-	-				
	Unit price		<b>LB 101 S</b>	123	-	-	-	246	-	-	342	342			
<b>M 10</b>		<b>M 50</b>		<b>M 50</b>		<b>M 80</b>				<b>M 90</b>					
LB1K M10 LB101 Laminate K005S Castell Oak K006P Light Grey K023P Stainless Steel Colour K039G Premium white glossy K039P Premium white K043P Graphite Black K058P Magic-grey K075P Black K076P Macaron K160F Snow White K160G Snow White Gloss K178F White Agate K190S Mammoth oak natural K199S Piemont Oak K216S natural mountain oak K218P Light Pepper K229S Classic Oak K230P Art Pepper K235P Titan Steel K236S Diamond Oak effect K247S Dark Maron effect K248P Light Nude K262S Royal Oak effect K263P Fango K269S Mountain Wood K270S Elegant walnut effect		LB1B M50 LB101 Velvet lacquer B006F Light Grey B039F Premium white B043F Graphite Black B058F Magic-grey B075F Black B076F Macaron B099F special colour B160F Snow White B178F White Agate B218F Light Pepper B230F Art Pepper B245F Night Green B248F Light Nude B263F Fango		LB1S M50 LB101 micro structured lacquer S006P Light Grey S039P Premium white S043P Graphite Black S058P Magic-grey S075P Black S076P Macaron S099P special colour S160P Snow White S178P White Agate S218P Light Pepper S230P Art Pepper S245P Night Green S248P Light Nude S263P Fango		LB1H M80 LB101 High Gloss Lacquer H006H Light Grey H039H Premium white H043H Graphite Black H058H Magic-grey H075H Black H076H Macaron H099H special colour H160H Snow White H178H White Agate H218H Light Pepper H230H Art Pepper H245H Night Green H248H Light Nude H263H Fango  LB1MP M80 LB101 Matt Lack Premium MP006 Light Grey MP039 Premium white MP043 Graphite Black MP058 Magic-grey MP075 Black MP076 Macaron MP099 special colour MP160 Snow White MP178 White Agate MP218 Light Pepper MP230 Art Pepper MP245 Night Green MP248 Light Nude MP263 Fango				LB1U M90 LB101 Matt lacquer gold applic U039M Premium White/gold-coloured					

# Light pelmets LB 102

		Order no. W H D		Hinge side:	Carcass depth	Decor groups									
						M10	M20	M30	M40	M50	M60	M70	M80	M90	
<b>Light pelmet</b>  <p>Including mitre cuts</p> <p>Extra charge rear lacquer</p> <p>Standard length 350 cm (not cut to size)</p>	 <b>Note:</b> Decor groups S/B: only available with glued outside mitre joints. Take account of item MP-AGV for each glued outside mitre joint.		per 10 cm Width												
	<b>LB 102</b>		-	-	-	-	19,30	-	-	-	-				
	<b>MP-RLB102</b>		-	-	-	-	7	-	-	-	-				
	Unit price		<b>LB 102 S</b>	-	-	-	413	-	-	-	-				
<b>M 50</b>		<b>M 50</b>		<b>M 80</b>		<b>M 80</b>				<b>M 90</b>					
LB2B M50 LB102 Velvet lacquer B006F Light Grey B039F Premium white B043F Graphite Black B058F Magic-grey B075F Black B076F Macaron B099F special colour B160F Snow White B169F Dolphin Grey B178F White Agate B218F Light Pepper B230F Art Pepper B245F Night Green B248F Light Nude B263F Fango		LB2S M50 LB102 micro structured lacquer S006P Light Grey S039P Premium white S043P Graphite Black S058P Magic-grey S075P Black S076P Macaron S099P special colour S160P Snow White S169P Dolphin Grey S178P White Agate S218P Light Pepper S230P Art Pepper S245P Night Green S248P Light Nude S263P Fango													



## Accessories

Laminate cutlery organiser	ZU. GL/XL1-ZU. GL/XL2
Low-frame laminate cutlery organiser	ZU. GL/XL2-ZU. GL/XL3
Cutlery organisation system TURN for drawers	ZU. GL/XL3
OrganiQ cutlery organiser	ZU. GL/XL4
Cuisio cutlery organiser	ZU. GL/XL5
Non-slip mat /felt mat	ZU. GL/XL6-ZU. GL/XL7
AMBIA Line cutlery organiser 55.5 cm deep	ZU. GL/XL8-ZU. GL/XL9
AMBIA Line cutlery organiser 70.5 cm deep	ZU. GL/XL10-ZU. GL/XL11
AMBIA Line pull-out partitioning	ZU. GL/XL11-ZU. GL/XL13
Real wood cutlery organiser 45.5 cm deep	ZU. GL/XL14
Real wood cutlery organiser 55.5 cm deep	ZU. GL/XL15-ZU. GL/XL16
Multi-insert real wood	ZU. GL/XL16
Real wood cutlery organiser 70.5 cm deep	ZU. GL/XL17
Real wood cutlery organiser accessories	ZU. GL/XL18
Real wood pull-out partitioning accessories	ZU. GL/XL19-ZU. GL/XL20
Solid oak design interior organization	ZU. GL/XL20-ZU. GL/XL22
Cutlery organisation system, solid oak design	ZU. GL/XL23-ZU. GL/XL24
Accessories Base units	ZU.XL/GL25-ZU.XL/GL31
Accessories	ZU.XL/GL32
Support legs	ZU.XL/GL32-ZU.XL/GL33
Ventilation grille	ZU.XL/GL33
Consoles/shelf supports	ZU.XL/GL33
Accessories Worktop and aperture design	ZU.XL/GL34
Accessories Wall units / dresser units	ZU.XL/GL34-ZU.XL/GL36
Accessories Wall units / Tall units	ZU.XL/GL36-ZU.XL/GL37
Accessories Tall units	ZU.XL/GL37-ZU.XL/GL39
Accessories Home Economics	ZU.XL/GL39-ZU.XL/GL40
Accessories Push to open	ZU.XL/GL40-ZU.XL/GL41
Accessories Hinges	ZU.XL/GL42-ZU.XL/GL43
Accessories	ZU.XL/GL44-ZU.XL/GL48
Drawers / Pull-outs	ZU.XL/GL48-ZU.XL/GL50
Adjustable shelves glass	ZU.XL/GL50
Adjustable shelves	ZU.XL/GL51

### Legend:



Planning advice



Merchandise net





# Laminate cutlery organiser



**Cutlery organisers for drawers**  
Carcase depth 45.5 cm

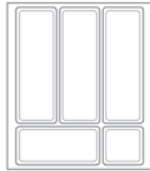
Order no.

Price

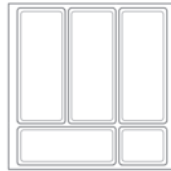
<b>BE-LB30-45</b>	17,10
<b>BE-LB40-45</b>	17,10
<b>BE-LB45-45</b>	17,10
<b>BE-LB50-45</b>	17,10
<b>BE-LB60-45</b>	17,10
<b>BE-LB80-45</b>	45
<b>BE-LB90-45</b>	45
<b>BE-LB100-45</b>	45
<b>BE-LB120-45</b>	53



30 cm



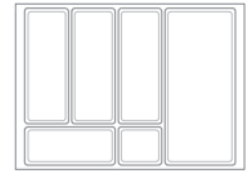
40 cm



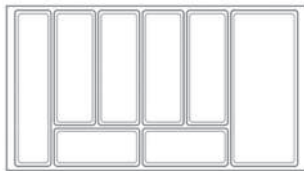
45 cm



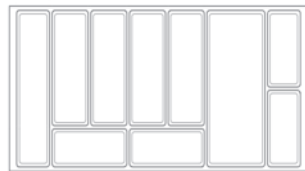
50 cm



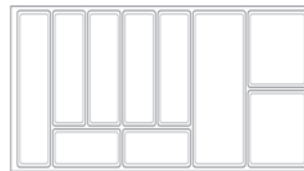
60 cm



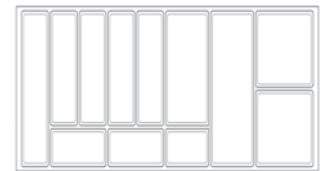
80 cm



90 cm



100 cm



120 cm

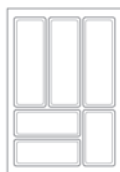


**Cutlery organisers for drawers**  
Carcase depth 55.5 cm/61 cm  
/  
Carcase depth 61 cm

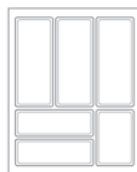
<b>BE-LB 30</b>	17,10
<b>BE-LB 40</b>	17,10
<b>BE-LB 45</b>	17,10
<b>BE-LB 50</b>	17,10
<b>BE-LB 60</b>	17,10
<b>BE-LB 80</b>	45
<b>BE-LB 90</b>	45
<b>BE-LB100</b>	45
<b>BE-LB120</b>	53



30 cm



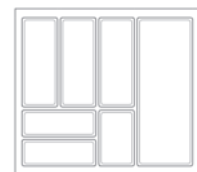
40 cm



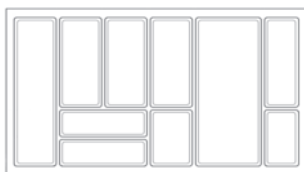
45 cm



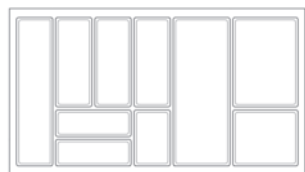
50 cm



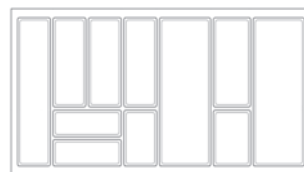
60 cm



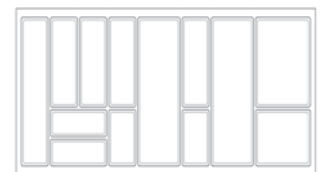
80 cm



90 cm



100 cm



120 cm



# Laminate cutlery organiser

Price

Order no.



**Cutlery organisers for drawers**  
Carcase depth 70.5 cm

<b>BE-LB30-70</b>	19,80
<b>BE-LB40-70</b>	21,40
<b>BE-LB45-70</b>	22,80
<b>BE-LB50-70</b>	24,20
<b>BE-LB60-70</b>	28,50
<b>BE-LB80-70</b>	45
<b>BE-LB90-70</b>	47
<b>BE-LB100-70</b>	51
<b>BE-LB120-70</b>	68



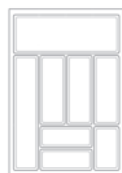
30 cm



40 cm



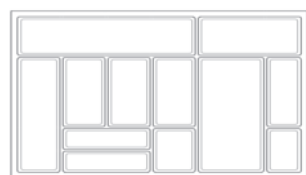
45 cm



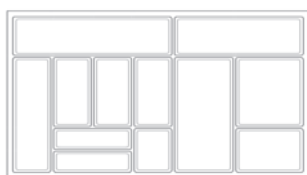
50 cm



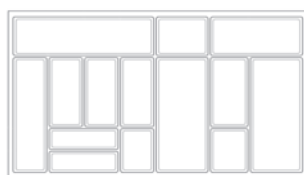
60 cm



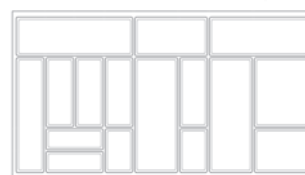
80 cm



90 cm



100 cm



120 cm

## Low-frame laminate cutlery organiser



**Cutlery organisers for uppermost drawer of hob base units UKI...**  
Carcase depth 55.5 cm/61 cm  
/  
Carcase depth 61 cm

<b>BE KI LB 60</b>	16,40
<b>BE KI LB 80</b>	29,70
<b>BE KI LB 90</b>	32
<b>BE KI LB 100</b>	39
<b>BE KI LB 120</b>	54



60 cm



80 cm



90 cm



100 cm



120 cm

### Interior dimensions carcase depth 55.5/61.0 cm W x D

Width 30 cm: 224 x 474 mm  
Width 40 cm: 324 x 474 mm  
Width 45 cm: 374 x 474 mm  
Width 50 cm: 424 x 474 mm  
Width 60 cm: 524 x 474 mm  
Width 70 cm: 624 x 474 mm  
Width 80 cm: 724 x 474 mm  
Width 90 cm: 824 x 474 mm  
Width 100 cm: 924 x 474 mm  
Width 120 cm: 1124 x 474 mm

### Interior dimensions carcase depth 45.5 cm W x D

Width 30 cm: 224 x 374 mm  
Width 40 cm: 324 x 374 mm  
Width 45 cm: 374 x 374 mm  
Width 50 cm: 424 x 374 mm  
Width 60 cm: 524 x 374 mm  
Width 70 cm: 624 x 374 mm  
Width 80 cm: 724 x 374 mm  
Width 90 cm: 824 x 374 mm  
Width 100 cm: 924 x 374 mm  
Width 120 cm: 1124 x 374 mm



Inner dimensions,  
carcase depth 33.9 cm W x D  
Width 30 cm: 224 x 274 mm  
Width 40 cm: 324 x 274 mm  
Width 45 cm: 374 x 274 mm  
Width 50 cm: 424 x 274 mm  
Width 60 cm: 524 x 274 mm  
Width 70 cm: 624 x 274 mm  
Width 80 cm: 724 x 274 mm  
Width 90 cm: 824 x 274 mm  
Width 100 cm: 924 x 274 mm  
Width 120 cm: 1124 x 274 mm

# Low-frame laminate cutlery organiser

Order no.

Price



## Cutlery organiser for spice jars

For 55.5 cm carcass depth  
/ Carcass depth 61 cm



*Planning advice:  
The maximum diameter of spice jars is 50 mm,  
when the spice insert is put in the upper drawer of a  
base cabinet.*

suitable for 60 cm wide drawers LEGRABOX  
For 30 spice jars

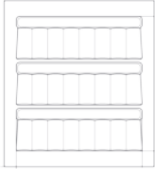
**BEG LB 60**

25,40

suitable for 50 cm wide drawers LEGRABOX  
for 24 spice jars

**BEG LB 50**

22,30



## Cutlery organisation system TURN for drawers



## Cutlery organisation system TURN for drawers

Anti-slip finish on surface  
Carcass depth 55.5 cm/61 cm  
/ Carcass depth 61 cm



*„TURN“ is unique in appearance, and combines cutlery  
insert and non-slip mat in a single innovative product.  
The space-saving straight division in combination with  
the flexible, non-slip mat gives an entirely new look to  
the cutlery organisers.  
Perfect for reduced width drawers.  
Cut to suit any special width.*

30 cm: consisting of 1 divider, 2 mats

**BE TU LB 30**

37

40 cm: consisting of 2 dividers, 3 mats

**BE TU LB 40**

58

45 cm: consisting of 1 cutlery insert L

**BE TU LB 45**

46

50 cm: consisting of 1 cutlery insert L

**BE TU LB 50**

46

60 cm: consisting of 1 cutlery insert XL

**BE TU LB 60**

51

80 cm: consisting of 1 cutlery insert XL, 1 divider, 1 mat

**BE TU LB 80**

75

90 cm: consisting of 1 cutlery insert XL, 2 dividers, 2 mats

**BE TU LB 90**

93

100 cm: consisting of 1 cutlery insert XL, 1 cutlery insert L, 1 divider

**BE TU LB 100**

107

120 cm: consisting of 2 cutlery inserts XL, 2 dividers, 1 mat

**BE TU LB 120**

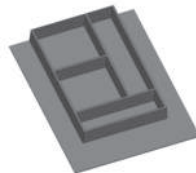
128



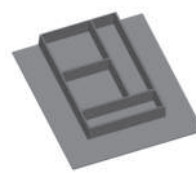
30 cm



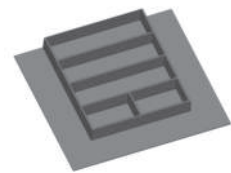
40 cm



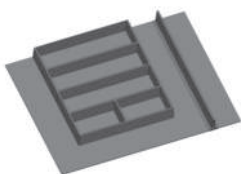
45 cm



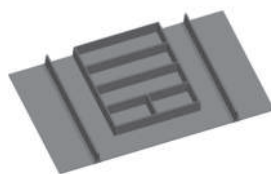
50 cm



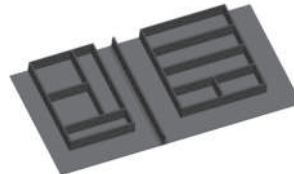
60 cm



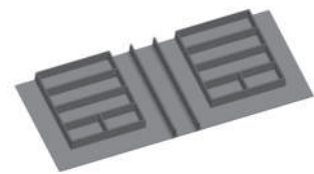
80 cm



90 cm



100 cm



120 cm

# OrganiQ cutlery organiser

Price

Order no.



**OrganiQ**  
**Cutlery organisers for drawers**  
 For 55.5 cm carcass depth  
 / Carcass depth 61 cm

<b>BE OQ LB 30</b>	39
<b>BE OQ LB 40</b>	59
<b>BE OQ LB 45</b>	61
<b>BE OQ LB 50</b>	64
<b>BE OQ LB 60</b>	74
<b>BE OQ LB 70</b>	78
<b>BE OQ LB 80</b>	85
<b>BE OQ LB 90</b>	96
<b>BE OQ LB 100</b>	107
<b>BE OQ LB 120</b>	134



30 cm



40 cm



45 cm



50 cm



60 cm



80 cm



90 cm



100 cm



120 cm



**\*= Knife block for cutlery organiser OrganiQ**  
 Dimensions: W: 137 mm D:472 mm H:226 mm

<b>BE OQ LB MB</b>	62
--------------------	----



**\*= Spice rack for cutlery organiser OrganiQ**  
 Dimensions: W: 137 mm D:472 mm H:226 mm

<b>BE OQ LB GT</b>	44
--------------------	----



**\*= Foil dispenser for cutlery organiser OrganiQ**  
 Dimensions: W: 137 mm D:472 mm H:238 mm

<b>BE OQ LB FR</b>	98
--------------------	----

From the material, through production, right through to recycling – during the development of OrganiQ by the company „Holzwerk Rockenhausen GmbH & Co. KG“ in cooperation with the Institute for Composite Materials at the University of Kaiserslautern, the focus was on the entire process chain. The perfect basis for producing OrganiQ in accordance with the most demanding quality criteria. Material: 78% natural fibres. Hemp and kenaf in the same proportion, 22% meshed duroplastic bonding material - water-based manufacture, free of formaldehyde and phenol resins.

The ingredients of the environmentally friendly OrganiQ.

Kenaf:

OrganiQ consists of rough-haired stems and lobed leaves of the plant Hibiscus cannabinus or kenaf.

The fibrous plant from the mallow family is similar to jute, but contains less lignin than jute.

Advantage: less sensitive to light  
 good tensile and flexural properties with low density

the light fibres improve the stiffness and heat resistance of products





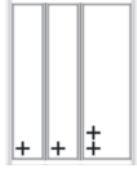




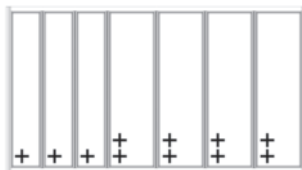


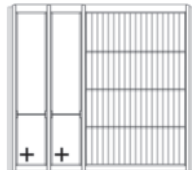

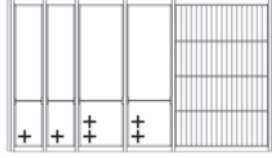
Hemp:

Hemp is one of the oldest and most versatile cultivated plants known to man.

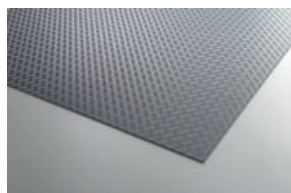
Its strong, deep taproot with many side arms and branches ensures intensive soil penetration. The advantage of the fibres lies in their very good resistance to wear and tear - the products feature

a longer service life; they can be reused through recycling.

# Cuisio cutlery organiser

		Order no.	Price	
	<b>Cutlery organisers Cuisio for drawers</b> Laminate, colour graphite, translucent adjustable organisers, Carcase depth 55.5 cm/61 cm / Carcase depth 61 cm  <i>must be planned for internal drawers: connection profile E-VCBI461</i>	<b>BE CU LB 30</b> <b>BE CU LB 40</b> <b>BE CU LB 45</b> <b>BE CU LB 50</b> <b>BE CU LB 60</b> <b>BE CU LB 80</b> <b>BE CU LB 90</b> <b>BE CU LB 100</b> <b>BE CU LB 120</b>	43 60 64 77 84 122 131 138 155	
		30 cm		
		40 cm		
		45 cm		
		50 cm		
		60 cm		
		80 cm		
		90 cm		
		100 cm		
		120 cm		
	<b>Connecting profile for Cuisio cutlery insert</b> must be planned in combination with internal drawers Length 461 mm, stainless steel-coloured Price per item	<b>E-VCBI461</b>	5,50	
	<b>Cuisio cutlery organisers with spice insert for drawers</b> Laminate, colour graphite, translucent For 55.5 cm carcase depth / Carcase depth 61 cm  <i>Not available for: internal drawer must be planned for internal drawers: connection profile E-VCBI461</i>	<b>BEG CU LB 60</b> <b>BEG CU LB 90</b>	91 142	
	<b>Cuisio partition plate</b> += for 100 mm trays +++ for 150 mm trays	<b>E-ZBKTW 10</b> <b>E-ZBKTW 15</b>	12,20 13,40	

## Non-slip mat /felt mat



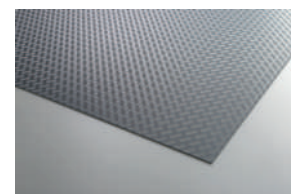
### Non-slip mat for LEGRABOX system

Suitable for drawers and pull-outs - order additionally For 55.5 cm carcass depth  
/  
Carcass depth 61 cm

Order no.

Price

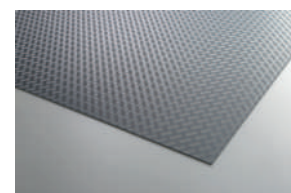
<b>AM-LB 30</b>	14,80
<b>AM-LB 40</b>	16,20
<b>AM-LB 45</b>	16,20
<b>AM-LB 50</b>	17,70
<b>AM-LB 60</b>	22,30
<b>AM-LB 70</b>	26
<b>AM-LB 80</b>	26
<b>AM-LB 90</b>	26,90
<b>AM-LB100</b>	27,90
<b>AM-LB120</b>	32



### Non-slip mat for LEGRABOX system

Suitable for drawers and pull-outs - order additionally for carcass depth 45.5 cm

<b>AM-LB30-45</b>	14,80
<b>AM-LB40-45</b>	16,20
<b>AM-LB45-45</b>	16,20
<b>AM-LB50-45</b>	17,70
<b>AM-LB60-45</b>	22,30
<b>AM-LB70-45</b>	26
<b>AM-LB80-45</b>	26
<b>AM-LB90-45</b>	26,90
<b>AM-LB100-45</b>	27,90
<b>AM-LB120-45</b>	32



### Non-slip mat for LEGRABOX system

Suitable for drawers and pull-outs - order additionally  
For 70.5 cm carcass depth

<b>AM-LB45-70</b>	16,20
<b>AM-LB50-70</b>	17,70
<b>AM-LB60-70</b>	22,30
<b>AM-LB70-70</b>	26
<b>AM-LB80-70</b>	26
<b>AM-LB90-70</b>	26,90
<b>AM-LB100-70</b>	27,90
<b>AM-LB120-70</b>	32

# Non-slip mat /felt mat

		Order no.	Price
	<b>Felt mat for the LEGRABOX system</b> Suitable for drawers and pull-outs - order additionally For 55.5 cm carcass depth / Carcass depth 61 cm	<b>FM-LB 30</b>	21.80
		<b>FM-LB 40</b>	33
		<b>FM-LB 45</b>	36
		<b>FM-LB 50</b>	42
		<b>FM-LB 60</b>	51
		<b>FM-LB 70</b>	70
		<b>FM-LB 80</b>	72
		<b>FM-LB 90</b>	82
		<b>FM-LB100</b>	90
		<b>FM-LB120</b>	110
	<b>Felt mat for the LEGRABOX system</b> Suitable for drawers and pull-outs - order additionally for carcass depth 45.5 cm	<b>FM-LB3045</b>	20
		<b>FM-LB4045</b>	29.10
		<b>FM-LB4545</b>	34
		<b>FM-LB5045</b>	38
		<b>FM-LB6045</b>	47
		<b>FM-LB7045</b>	64
		<b>FM-LB8045</b>	66
		<b>FM-LB9045</b>	75
		<b>FM-LB10045</b>	83
		<b>FM-LB12045</b>	102
	<b>Felt mat for the LEGRABOX system</b> Suitable for drawers and pull-outs - order additionally For 70.5 cm carcass depth	<b>FM-LB3070</b>	34
		<b>FM-LB4070</b>	48
		<b>FM-LB4570</b>	59
		<b>FM-LB5070</b>	66
		<b>FM-LB6070</b>	80
		<b>FM-LB7070</b>	106
		<b>FM-LB8070</b>	110
		<b>FM-LB9070</b>	123
		<b>FM-LB10070</b>	141
		<b>FM-LB12070</b>	173

### The new Generation Felt: **plant-based and ecological**

Using renewable raw materials instead of finite resources, paying attention to sustainability, ecology and environmental friendliness - this is becoming increasingly more important for ever more people. This material was created based on this awareness. It is a purely plant-based product made from rapidly renewable raw materials - plant residues and wood fibres - which are obtained sustainably and processed in Germany in an environmentally friendly manner in accordance with the latest technical standards. The material is therefore of a high quality and looks like good woollen felt, but contains no animal components - ideal for vegans and many allergy sufferers. It is biodegradable and so non-toxic that small children can safely put the material in their mouths. Two more advantages! Care tip: treat products made of this material like textiles made of wool or other fine materials. You can machine wash them at 30°C, but it is best not to spin them, rather to dry them flat. Use a mild detergent and avoid bleach. Also, do not use aggressive chemicals to remove individual stains. When ironing, please set the iron to „Wool“ - these tips ensure that you can enjoy your products for a long time



#### Interior dimensions carcass depth 55.5/61.0 cm W x D

Width 30 cm: 224 x 474 mm  
 Width 40 cm: 324 x 474 mm  
 Width 45 cm: 374 x 474 mm  
 Width 50 cm: 424 x 474 mm  
 Width 60 cm: 524 x 474 mm  
 Width 70 cm: 624 x 474 mm  
 Width 80 cm: 724 x 474 mm  
 Width 90 cm: 824 x 474 mm  
 Width 100 cm: 924 x 474 mm  
 Width 120 cm: 1124 x 474 mm

#### Interior dimensions carcass depth 45.5 cm W x D


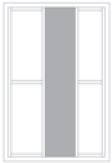
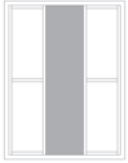
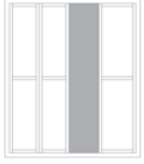





Width 30 cm: 224 x 374 mm  
 Width 40 cm: 324 x 374 mm  
 Width 45 cm: 374 x 374 mm  
 Width 50 cm: 424 x 374 mm  
 Width 60 cm: 524 x 374 mm  
 Width 70 cm: 624 x 374 mm  
 Width 80 cm: 724 x 374 mm  
 Width 90 cm: 824 x 374 mm  
 Width 100 cm: 924 x 374 mm  
 Width 120 cm: 1124 x 374 mm

#### Inner dimensions, carcass depth 33.9 cm W x D

Width 30 cm: 224 x 274 mm  
 Width 40 cm: 324 x 274 mm  
 Width 45 cm: 374 x 274 mm  
 Width 50 cm: 424 x 274 mm  
 Width 60 cm: 524 x 274 mm  
 Width 70 cm: 624 x 274 mm  
 Width 80 cm: 724 x 274 mm  
 Width 90 cm: 824 x 274 mm  
 Width 100 cm: 924 x 274 mm  
 Width 120 cm: 1124 x 274 mm

# AMBIA Line cutlery organiser 55.5 cm deep

Carcase depth 55.5 cm (standard)

		Order no.	Price
	<p><b>Cutlery organisers „AMBIA-LINE“</b> For 55.5 cm carcass depth Can be individually positioned</p> <p><b>for drawer width 30 cm</b> consisting of 1 AMBIA-LINE frame 124 mm with 1 cross-divider 1 AMBIA-LINE frame 100 mm with 1 cross-divider</p>	<b>Z SKAL 30</b>	66
	<p><b>Cutlery organisers „AMBIA-LINE“</b> For 55.5 cm carcass depth Can be individually positioned</p> <p>for drawer width 40 cm consisting of 1 AMBIA-LINE frame 124 mm with 1 cross-divider 1 AMBIA-LINE frame 100 mm with 1 cross-divider</p>	<b>Z SKAL 40</b>	66
	<p><b>Cutlery organisers „AMBIA-LINE“</b> For 55.5 cm carcass depth Can be individually positioned</p> <p><b>for drawer width 45 cm</b>, consisting of 2 AMBIA-LINE frames 124 mm with 1 cross-divider each</p>	<b>Z SKAL 45</b>	72
	<p><b>Cutlery organisers „AMBIA-LINE“</b> For 55.5 cm carcass depth Can be individually positioned</p> <p><b>for drawer width 50 cm</b>, consisting of 2 AMBIA-LINE frames 100 mm with 1 cross-divider each 1 AMBIA-LINE frame 124 mm with 1 cross-divider</p>	<b>Z SKAL 50</b>	91
	<p><b>Cutlery organisers „AMBIA-LINE“</b> for drawer width 60 cm For 55.5 cm carcass depth Can be individually positioned 2 AMBIA-LINE frames 100 mm with 1 cross-divider each 1 AMBIA-LINE frame 124 mm with 1 cross-divider</p>	<b>Z SKAL 60</b>	91
	<p><b>Cutlery organisers „AMBIA-LINE“</b> For 55.5 cm carcass depth Can be individually positioned for drawer width 80 cm consisting of: 1 AMBIA-LINE frame 200 mm with 1 cross-divider 2 AMBIA-LINE frames 100 mm with 1 cross-divider each 1 AMBIA-LINE frame 124 mm with 1 cross-divider</p>	<b>Z SKAL 80</b>	125
	<p><b>Cutlery organisers „AMBIA-LINE“</b> For 55.5 cm carcass depth Can be individually positioned for drawer width 90 cm consisting of: 1 AMBIA-LINE frame 200 mm with 1 cross-divider 2 AMBIA-LINE frames 100 mm with 1 cross-divider each 1 AMBIA-LINE frame 124 mm with 1 cross-divider</p>	<b>Z SKAL 90</b>	125
	<p><b>Cutlery organisers „AMBIA-LINE“</b> For 55.5 cm carcass depth Can be individually positioned for drawer width 100 cm consisting of: 1 AMBIA-LINE frame 200 mm with 1 cross-divider 1 AMBIA-LINE frame 124 mm with 1 cross-divider 2 AMBIA-LINE frames 100 mm with 1 cross-divider each</p>	<b>Z SKAL 100</b>	125
	<p><b>Cutlery organisers „AMBIA-LINE“</b> For 55.5 cm carcass depth Can be individually positioned for drawer width 120 cm consisting of: 2 AMBIA-LINE frames 200 mm with 1 cross-divider each 1 AMBIA-LINE frame 124 mm with 1 cross-divider 2 AMBIA-LINE frames 100 mm with 1 cross-divider each</p>	<b>Z SKAL 120</b>	162

**Note:** We recommend non-slip mats AM-LB... in conjunction with the accessories for LEGRABOX as an addition.

ZU, GL/XL8

 = Merchandise net



# AMBIA Line cutlery organiser 55.5 cm deep

Carcase depth 55.5 cm (standard)

		Order no.	Price
<b>Single parts for supplements and individual combinations:</b>			
	AMBIA-LINE frame 100 mm wide	<b>Z SKAL R 100</b>	29
	AMBIA-LINE cross-divider for drawer frame 100 mm wide	<b>Z SKAL QT 100</b>	10.40
<b>Single parts for supplements and individual combinations:</b>			
	AMBIA-LINE frame 124 mm wide	<b>Z SKAL R 124</b>	35
	AMBIA-LINE cross-divider for drawer frame 124 mm wide	<b>Z SKAL QT 124</b>	10.40
<b>Single parts for supplements and individual combinations:</b>			
	AMBIA-LINE frame 200 mm wide	<b>Z SKAL R 200</b>	35
	AMBIA-LINE cross-divider for drawer frame 200 mm wide	<b>Z SKAL QT 200</b>	11.80
	<b>AMBIA-LINE knife block</b> For 4 large and 5 small knives 187 mm wide Suitable for AMBIA-LINE frame 200 mm	<b>Z SKAL MH</b>	38
	<b>AMBIA-LINE foil dispenser</b> (with foil), 187 mm wide Suitable for AMBIA-LINE frame 200 mm	<b>Z SKAL FS</b>	88
	<b>Cutlery insert</b> Steel frame with integrated trays, tray facing made of soft-touch material, resistant, noise reducing surface 6 cutlery compartments, width 300 mm	<b>Z SKALB 300</b>	106

You can determine the total available width for the **individual** combination of the frames within a drawer / pull-out as follows:


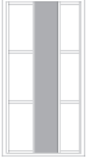
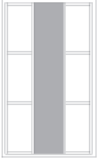
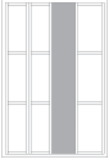
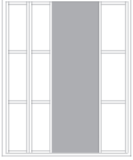

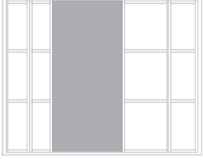
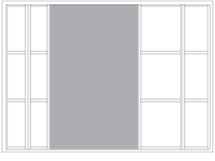
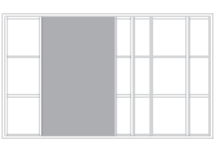
**Carcase width J. 76 mm**

**Note:** We recommend non-slip mats AM-LB... in conjunction with the accessories for LEGRABOX as an addition.

☐ = Merchandise net

# AMBIA Line cutlery organiser 70.5 cm deep

Carcase depth 70.5 cm

		Order no.	Price
	<p><b>Cutlery organisers „AMBIA-LINE“</b>                      For 70.5 cm carcase depth  <b>for drawer width 30 cm</b>                      consisting of:                      1 AMBIA-LINE frame 124 mm with 2 cross-dividers                      1 AMBIA-LINE frame 100 mm with 2 cross-dividers</p>	<b>Z SKAL 30-70</b>	69
	<p><b>Cutlery organisers „AMBIA-LINE“</b>                      For 70.5 cm carcase depth                      for drawer width 40 cm                      consisting of:                      1 AMBIA-LINE frame 124 mm with 2 cross-dividers                      1 AMBIA-LINE frame 100 mm with 2 cross-dividers</p>	<b>Z SKAL 40-70</b>	69
	<p><b>Cutlery organisers „AMBIA-LINE“</b>                      For 70.5 cm carcase depth                      for drawer width 45 cm                      consisting of:                      2 AMBIA-LINE frames 124 mm with 2 cross-divider each</p>	<b>Z SKAL 45-70</b>	77
	<p><b>Cutlery organisers „AMBIA-LINE“</b>                      For 70.5 cm carcase depth                      for drawer width 50 cm                      consisting of:                      2 AMBIA-LINE frames 100 mm with 2 cross-divider each                      1 AMBIA-LINE frame 124 mm with 2 cross-dividers</p>	<b>Z SKAL 50-70</b>	101
	<p><b>Cutlery organisers „AMBIA-LINE“</b>                      For 70.5 cm carcase depth                      for drawer width 60 cm                      consisting of:                      2 AMBIA-LINE frames 100 mm with 2 cross-divider each                      1 AMBIA-LINE frame 124 mm with 2 cross-dividers</p>	<b>Z SKAL 60-70</b>	101
	<p><b>Cutlery organisers „AMBIA-LINE“</b>                      For 70.5 cm carcase depth                      for drawer width 80 cm                      consisting of:                      1 AMBIA-LINE frame 200 mm with 2 cross-divider                      2 AMBIA-LINE frames 100 mm with 2 cross-divider each                      1 AMBIA-LINE frame 124 mm with 2 cross-dividers</p>	<b>Z SKAL 80-70</b>	139
	<p><b>Cutlery organisers „AMBIA-LINE“</b>                      For 70.5 cm carcase depth                      for drawer width 90 cm                      consisting of:                      1 AMBIA-LINE frame 200 mm with 2 cross-divider                      2 AMBIA-LINE frames 100 mm with 2 cross-divider each                      1 AMBIA-LINE frame 124 mm with 2 cross-dividers</p>	<b>Z SKAL 90-70</b>	139
	<p><b>Cutlery organisers „AMBIA-LINE“</b>                      For 70.5 cm carcase depth                      for drawer width 100 cm                      consisting of:                      1 AMBIA-LINE frame 200 mm with 2 cross-divider                      1 AMBIA-LINE frame 124 mm with 2 cross-dividers                      2 AMBIA-LINE frames 100 mm with 2 cross-divider each</p>	<b>Z SKAL 100-70</b>	139
	<p><b>Cutlery organisers „AMBIA-LINE“</b>                      For 70.5 cm carcase depth                      for drawer width 120 cm                      consisting of:                      2 AMBIA-LINE frames 200 mm with 2 cross-divider each                      1 AMBIA-LINE frame 124 mm with 2 cross-dividers                      2 AMBIA-LINE frames 100 mm with 2 cross-divider each</p>	<b>Z SKAL 120-70</b>	176

# AMBIA Line cutlery organiser 70.5 cm deep



Carcase depth 70.5 cm

		Order no.	Price
	<b>Single parts for supplements and individual combinations:</b>		
	AMBIA-LINE frame 100 mm wide	<b>Z SKAL R 100-70</b>	<input type="text" value="32"/>
	AMBIA-LINE cross-divider for drawer frame 100 mm wide	<b>Z SKAL QT 100</b>	<input type="text" value="10.40"/>
	<b>Single parts for supplements and individual combinations:</b>		
	AMBIA-LINE frame 124 mm wide	<b>Z SKAL R 124-70</b>	<input type="text" value="39"/>
	AMBIA-LINE cross-divider for drawer frame 124 mm wide	<b>Z SKAL QT 124</b>	<input type="text" value="10.40"/>
	<b>Single parts for supplements and individual combinations:</b>		
	AMBIA-LINE frame 200 mm wide	<b>Z SKAL R 200-70</b>	<input type="text" value="39"/>
	AMBIA-LINE cross-divider for drawer frame 200 mm wide	<b>Z SKAL QT 200</b>	<input type="text" value="11.80"/>
	<b>Cutlery insert</b> Steel frame with integrated trays, tray facing made of soft-touch material, resistant, noise reducing surface 6 cutlery compartments, width 300 mm	<b>Z SKALB 300-70</b>	<input type="text" value="200"/>

You can determine the total available width for the **individual** combination of the frames within a drawer / pull-out as follows:

**Carcase width J. 76 mm**



## AMBIA Line pull-out partitioning

	<b>AMBIA-LINE</b>		
	<b>AMBIA-LINE frame for pull-out LEGRABOX</b> 270 mm long, 242 mm wide, 110 mm high	<b>Z AZAL R270</b>	<input type="text" value="61"/>
	AMBIA-LINE Cross divider for pull-out frame 242 mm wide	<b>Z AZAL QT242</b>	<input type="text" value="14.10"/>

# AMBIA Line pull-out partitioning

		Order no.	Price
	<b>AMBIA-LINE</b>  <b>AMBIA-LINE frame for pull-out LEGRABOX</b> 370 mm long, 218 mm wide, 110 mm high	<b>Z AZAL R400</b>	62
	AMBIA-LINE Cross divider for pull-out frame 218 mm wide	<b>Z AZAL QT218</b>	14,10
	<b>AMBIA-LINE plate rack</b> 170 mm high For plates with diameter 186-321 mm Infinitely variable, for up to 12 plates	<b>Z AZAL TH</b>	54
	<b>AMBIA-LINE spice jar holder</b> 1 item, brushed stainless less lacquered Suitable for frame <b>Z AZAL R400</b>	<b>Z AZAL GH</b>	58
	<b>AMBIA-LINE bottle set 100 mm</b> For pull-outs (not for internal pull-outs) consisting of: 1 bottle set 100 mm incl. 3 cross-dividers For 100 mm frames ZSKALR 100 and ZSKALR 100-70  <i>Not suitable for internal pull-outs. Articles ZSKALR 100 and ZSKALR 100-70 are not included in the bottle set.</i>	<b>Z AZAL F100</b>	25
	<b>AMBIA-LINE bottle set 200 mm</b> For pull-outs (not for internal pull-outs) consisting of: 1 bottle set 200 mm incl. 3 cross-dividers 200 mm For 200 mm frames ZSKALR 200 and ZSKALR 200-70  <i>Not suitable for internal pull-outs. Articles ZSKALR 200 and ZSKALR 200-70 are not included in the bottle set.</i>	<b>Z AZAL F200</b>	32
	<b>Additional lengthways divider</b>	<b>LT LB</b>	5,80

# AMBIA Line pull-out partitioning

		Order no.	Price
	<b>Cross-rail set for pull-outs LEGRABOX pure ART and pure WOOD</b>		
	for width 60 cm: comprising 1 cross-rail, 2 lengthways dividers, 2 cross-rail brackets	<b>QR LBP 60</b>	<input type="text" value="32"/>
	for width 90 cm: comprising 1 cross-rail, 3 lengthways dividers, 2 cross-rail brackets	<b>QR LBP 90</b>	<input type="text" value="36"/>
	for width 120 cm: comprising 1 cross-rail, 4 lengthways dividers, 2 cross-rail brackets	<b>QR LBP 120</b>	<input type="text" value="41"/>
	AMBIA-LINE SET crossrail holder	<b>Z SKAL QR HP</b>	<input type="text" value="21.30"/>
	<b>Cross-rail set for pull-outs LEGRABOX free ART</b>		
	for width 60 cm: comprising 1 cross-rail, 2 lengthways dividers, 2 cross-rail brackets	<b>QR LBF 60</b>	<input type="text" value="32"/>
	for width 90 cm: comprising 1 cross-rail, 3 lengthways dividers, 2 cross-rail brackets	<b>QR LBF 90</b>	<input type="text" value="36"/>
	for width 120 cm: comprising 1 cross-rail, 4 lengthways dividers, 2 cross-rail brackets	<b>QR LBF 120</b>	<input type="text" value="41"/>
	AMBIA-LINE SET crossrail holder	<b>Z SKAL QR HF</b>	<input type="text" value="21.30"/>

# Real wood cutlery organiser 45.5 cm deep

Carcase depth 45.5 cm (standard)

Price

Order no.



### Cutlery insert

Comprising one 4 mm veneered baseboard and fixed, lacquered, solid partition walls  
Carcase depth 45.5 cm  
Finish: Real wood ash dark

BE	H LB	30-45	69
BE	H LB	40-45	90
BE	H LB	45-45	91
BE	H LB	50-45	94
BE	H LB	60-45	106
BE	H LB	70-45	109
BE	H LB	80-45	117
BE	H LB	90-45	128
BE	H LB	100-45	139
BE	H LB	120-45	158



30 cm



40 cm



45 cm



50 cm



60 cm



80 cm



90 cm



100 cm



120 cm



### Cutlery insert

Comprising one 4 mm veneered baseboard and fixed, lacquered, solid partition walls  
Carcase depth 45.5 cm  
Finish: real wood light oak

BE	HE LB	30-45	69
BE	HE LB	40-45	90
BE	HE LB	45-45	91
BE	HE LB	50-45	94
BE	HE LB	60-45	106
BE	HE LB	70-45	109
BE	HE LB	80-45	117
BE	HE LB	90-45	128
BE	HE LB	100-45	139
BE	HE LB	120-45	158



30 cm



40 cm



45 cm



50 cm



60 cm



80 cm



90 cm



100 cm



120 cm

Note: The individual/hand production requires a minimum production time of 15 working days.

ZU. GL/XL14

☐ = Merchandise net

# Real wood cutlery organiser 55.5 cm deep

Carcase depth 55.5 cm (standard)



## Cutlery insert

Comprising one 4 mm veneered baseboard and fixed, lacquered, solid partition walls  
Carcase depth 55.5 cm/61 cm  
Finish: Real wood ash dark



\*= marked areas can be fitted with the following items.  
BE H LBMB Knife block for drawers  
BE H LBGT Spice rack for cutlery organisers  
BE H LBFH Foil holder for cutlery organiser  
BE H LBKE Cross insert for cutlery organiser  
BE-HLBGP Universal spice rack  
BE-HLBGAA Spice rack suitable for 6 spice jars

Order no.

Price

BE	H LB	30	75
BE	H LB	40	98
BE	H LB	45	102
BE	H LB	50	106
BE	H LB	60	120
BE	H LB	70	126
BE	H LB	80	138
BE	H LB	90	152
BE	H LB	100	171
BE	H LB	120	202



30 cm



40 cm



45 cm



50 cm



60 cm



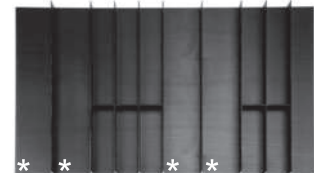
80 cm



90 cm



100 cm



120 cm



## Cutlery insert

Comprising one 4 mm veneered baseboard and fixed, lacquered, solid partition walls  
Carcase depth 55.5 cm/61 cm  
Finish: real wood light oak



\*= marked areas can be fitted with the following items.  
BE HE LBMB Knife block for drawers  
BE HE LBGT Spice rack for cutlery organisers  
BE HE LBFH Foil holder for cutlery organiser  
BE HE LBKE Cross insert for cutlery organiser  
BE-HELBGP Universal spice rack  
BE-HELBGAA Spice rack suitable for 6 spice jars

BE	HE LB	30	75
BE	HE LB	40	98
BE	HE LB	45	102
BE	HE LB	50	106
BE	HE LB	60	120
BE	HE LB	70	126
BE	HE LB	80	138
BE	HE LB	90	152
BE	HE LB	100	171
BE	HE LB	120	202



30 cm



40 cm



45 cm



50 cm



60 cm



80 cm



90 cm



100 cm



120 cm

Note: The individual/hand production requires a minimum production time of 15 working days.

☐ = Merchandise net



# Real wood cutlery organiser 55.5 cm deep

Carcase depth 55.5 cm (standard)

Price

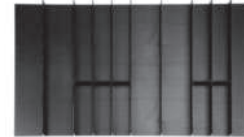
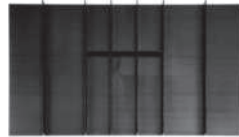
Order no.



## Cutlery insert

For uppermost drawer of hob base units UKI...  
Comprising one 4 mm veneered baseboard and fixed, lacquered, solid partition walls  
Carcase depth 55.5 cm/61 cm  
Finish: Real wood ash dark

BE	H	KI	LB	60	110
BE	H	KI	LB	70	117
BE	H	KI	LB	80	122
BE	H	KI	LB	90	134
BE	H	KI	LB	100	146
BE	H	KI	LB	120	168



60 cm

80 cm

90 cm

100 cm

120 cm



## Cutlery insert

For uppermost drawer of hob base units UKI...  
Comprising one 4 mm veneered baseboard and fixed, lacquered, solid partition walls  
Carcase depth 55.5 cm/61 cm  
Finish: real wood light oak

BE	HE	KI	LB	60	110
BE	HE	KI	LB	70	117
BE	HE	KI	LB	80	122
BE	HE	KI	LB	90	134
BE	HE	KI	LB	100	146
BE	HE	KI	LB	120	168



60 cm

80 cm

90 cm

100 cm

120 cm

## Multi-insert real wood



## Multi-insert

Comprising one 4 mm veneered baseboard and fixed, lacquered, solid partition walls  
Carcase depth 55.5 cm/61 cm



\*= marked areas can be fitted with the following items.

- BE H LBMB Knife block for drawers
- BE H LBGT Spice rack for cutlery organisers
- BE H LBFH Foil holder for cutlery organiser
- BE H LBKE Cross insert for cutlery organiser
- BE-HLBGP Universal spice rack
- BE-HLBGAA Spice rack suitable for 6 spice jars



Finish: Real wood ash dark

real wood light oak Finish:

Finish: Real wood ash dark

Finish: real wood light oak

ME	H	LB	60	104
ME	HE	LB	60	104
ME	H	LB	90	141
ME	HE	LB	90	141



## Multi-insert

Comprising one 4 mm veneered baseboard and fixed, lacquered, solid partition walls  
Carcase depth 70.5 cm



\*= marked areas can be fitted with the following items.

- BE H LBMB Knife block for drawers
- BE H LBGT Spice rack for cutlery organisers
- BE H LBFH Foil holder for cutlery organiser
- BE H LBKE Cross insert for cutlery organiser
- BE-HLBGP Universal spice rack
- BE-HLBGAA Spice rack suitable for 6 spice jars



Finish: Real wood ash dark

Finish: real wood light oak

Finish: Real wood ash dark

Finish: real wood light oak

ME	H	LB	60-70	138
ME	HE	LB	60-70	138
ME	H	LB	90-70	165
ME	HE	LB	90-70	165

Note: The individual/hand production requires a minimum production time of 15 working days.

ZU. GL/XL16  = Merchandise net

# Real wood cutlery organiser 70.5 cm deep

Carcase depth 70.5 cm

Price

Order no.



## Cutlery insert

Comprising one 4 mm veneered baseboard and fixed, lacquered, solid partition walls  
Carcase depth 70.5 cm  
Finish: Real wood ash dark



\*= marked areas can be fitted with the following items.

- BE H LBMB Knife block for drawers
- BE H LBGT Spice rack for cutlery organisers
- BE H LBFH Foil holder for cutlery organiser
- BE H LBKE Cross insert for cutlery organiser
- BE-HLBGP Universal spice rack
- BE-HLBGAA Spice rack suitable for 6 spice jars

BE	H LB	30-70	98
BE	H LB	40-70	125
BE	H LB	45-70	125
BE	H LB	50-70	134
BE	H LB	60-70	144
BE	H LB	70-70	150
BE	H LB	80-70	163
BE	H LB	90-70	178
BE	H LB	100-70	190
BE	H LB	120-70	218



30 cm



40 cm



45 cm



50 cm



60 cm



80 cm



90 cm



100 cm



120 cm



## Cutlery insert

Comprising one 4 mm veneered baseboard and fixed, lacquered, solid partition walls  
Carcase depth 70.5 cm  
Finish: real wood light oak



\*= marked areas can be fitted with the following items.

- BE HE LBMB Knife block for drawers
- BE HE LBGT Spice rack for cutlery organisers
- BE HE LBFH Foil holder for cutlery organiser
- BE HE LBKE Cross insert for cutlery organiser
- BE-HELBGP Universal spice rack
- BE-HELBGAA Spice rack suitable for 6 spice jars

BE	HE LB	30-70	98
BE	HE LB	40-70	125
BE	HE LB	45-70	125
BE	HE LB	50-70	134
BE	HE LB	60-70	144
BE	HE LB	70-70	150
BE	HE LB	80-70	163
BE	HE LB	90-70	178
BE	HE LB	100-70	190
BE	HE LB	120-70	218



30 cm



40 cm



45 cm



50 cm



60 cm



80 cm



90 cm



100 cm















120 cm













Note: The individual/hand production requires a minimum production time of 15 working days.


☐ = Merchandise net

# Real wood cutlery organiser accessories





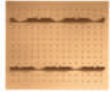


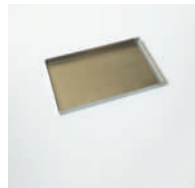
		Order no.	Price
<p><b>Knife block for drawers</b> Dimensions: W: 137 mm H: 26 mm D: 472 mm</p>			
	*= Finish: Real wood ash dark	<b>BE H LB MB</b>	96
	*= Finish: real wood light oak	<b>BE HE LB MB</b>	96
<p><b>Spice rack for cutlery organisers</b> Dimensions: W: 137 mm H: 26 mm D: 472 mm</p>			
	*= Finish: Real wood ash dark	<b>BE H LB GT</b>	74
	*= Finish: real wood light oak	<b>BE HE LB GT</b>	74
<p><b>Foil holder for cutlery organiser</b> Dimensions: W: 137 mm H: 37 mm D: 472 mm</p>			
	Finish: Real wood ash dark	<b>BE H LB FH</b>	120
	*= Finish: real wood light oak	<b>BE HE LB FH</b>	120
<p><b>Cross insert for cutlery organiser</b> Dimensions: W: 137 mm H: 37 mm D: 472 mm</p>			
	*= Finish: Real wood ash dark	<b>BE H LB KE</b>	67
	*= Finish: real wood light oak	<b>BE HE LB KE</b>	67
<p><b>Universal spice rack</b> Dimensions: W: 137 mm D: 472 mm H: 8 mm</p>			
	*= Finish: Real wood ash dark	<b>BE-HLBGP</b>	83
	*= Finish: real wood light oak	<b>BE-HELBGP</b>	83
<p><b>Spice rack suitable for 6 spice jars</b> Dimensions: W: 137 mm D: 472 mm H: 8 mm</p>			
	*= Finish: Real wood ash dark	<b>BE-HLBGAA</b>	82
	*= Finish: real wood light oak	<b>BE-HELBGAA</b>	82

# Real wood pull-out partitioning accessories


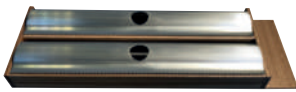
		Order no.	Price	
	<b>Perforated baseboard real ash wood 8 mm</b> Carcase depth 55.5 cm/61 cm Pull-out organisation system Perforated baseboard 8 mm veneered With grid 32 mm			
	Finish: Real wood ash dark	<b>AZ H LB LP 60</b>	83	
	Finish: Real wood ash dark	<b>AZ H LB LP 70</b>	99	
	Finish: Real wood ash dark	<b>AZ H LB LP 80</b>	102	
	Finish: Real wood ash dark	<b>AZ H LB LP 90</b>	109	
	Finish: Real wood ash dark	<b>AZ H LB LP 100</b>	117	
	Finish: Real wood ash dark	<b>AZ H LB LP 120</b>	133	
	Finish: real wood light oak	<b>AZ HE LB LP 60</b>	83	
	Finish: real wood light oak	<b>AZ HE LB LP 70</b>	99	
	Finish: real wood light oak	<b>AZ HE LB LP 80</b>	102	
	Finish: real wood light oak	<b>AZ HE LB LP 90</b>	109	
	Finish: real wood light oak	<b>AZ HE LB LP 100</b>	117	
	Finish: real wood light oak	<b>AZ HE LB LP 120</b>	133	
	<hr/>			
		<b>Perforated baseboard real ash wood 8 mm</b> Carcase depth 70.5 cm Pull-out organisation system Perforated baseboard 8 mm veneered With grid 32 mm		
		Finish: Real wood ash dark	<b>AZ H LB LP 60-70</b>	102
	Finish: Real wood ash dark	<b>AZ H LB LP 70-70</b>	115	
	Finish: Real wood ash dark	<b>AZ H LB LP 80-70</b>	117	
	Finish: Real wood ash dark	<b>AZ H LB LP 90-70</b>	123	
	Finish: Real wood ash dark	<b>AZ H LB LP 100-70</b>	134	
	Finish: Real wood ash dark	<b>AZ H LB LP 120-70</b>	147	
	Finish: real wood light oak	<b>AZ HE LB LP 60-70</b>	102	
	Finish: real wood light oak	<b>AZ HE LB LP 70-70</b>	115	
	Finish: real wood light oak	<b>AZ HE LB LP 80-70</b>	117	
	Finish: real wood light oak	<b>AZ HE LB LP 90-70</b>	123	
	Finish: real wood light oak	<b>AZ HE LB LP 100-70</b>	134	
	Finish: real wood light oak	<b>AZ HE LB LP 120-70</b>	147	
	<hr/>			
		<b>Partition board</b> Dimensions: W: 460 mm H: 110 mm D: 11 mm		
		Finish: Real wood ash dark	<b>AZ H TB 47</b>	75
	Finish: real wood light oak	<b>AZ HE TB 47</b>	75	
<hr/>				
	<b>Set of round pegs</b> Dimensions: diameter 25 mm height: 160 mm			
	Finish: Real wood ash dark	<b>AZ HR S</b>	61	
	Finish: real wood light oak	<b>AZ HE RS</b>	61	
<hr/>				
	<b>Cross partition pull-out</b> Dimensions: W: 243 mm H: 80 mm D: 229 mm			
	Finish: Real wood ash dark	<b>AZ H KR</b>	82	
	Finish: real wood light oak	<b>AZ HE KR</b>	82	
<hr/>				
	<b>Partition board</b> Dimensions: W: 190 mm H: 110 mm D: 11 mm			
	Finish: Real wood ash dark	<b>AZ H TB 19</b>	54	
	Finish: real wood light oak	<b>AZ HE TB 19</b>	54	

**Note:** The individual/hand production requires a minimum production time of 15 working days.  
 = Merchandise net

## Real wood pull-out partitioning accessories

		Order no.	Price
	<b>Partition board</b> Dimensions: W: 126 mm H: 110 mm D: 11 mm Finish: Real wood ash dark	<b>AZ H TB 13</b>	53
	Finish: real wood light oak	<b>AZ HE TB 13</b>	53
  	<b>Pot lid holder with black felt</b> Dimensions: H: 11 mm D: 110 mm		
	Finish: Real wood ash dark	<b>AZ H TH 80</b>	171
	Finish: Real wood ash dark	<b>AZ H TH 90</b>	187
	Finish: Real wood ash dark	<b>AZ H TH 100</b>	197
	Finish: Real wood ash dark	<b>AZ H TH 120</b>	222
	Finish: real wood light oak	<b>AZ HE TH 80</b>	171
	Finish: real wood light oak	<b>AZ HE TH 90</b>	187
	Finish: real wood light oak	<b>AZ HE TH 100</b>	197
Finish: real wood light oak	<b>AZ HE TH 120</b>	222	
  	<b>Bottle rack - pair</b> Dimensions: W: 460 mm H: 8 mm D: 50 mm Finish: Real wood ash dark	<b>AZ H FH</b>	77
	Finish: real wood light oak	<b>AZ HE FH</b>	77
  	<b>Ceramic storage jars with holder</b> <b>Set of 3</b> Dimensions: W: 460 mm H: 150 mm D: 16 mm Finish: Real wood ash dark	<b>AZ H KVD</b>	192
	Finish: real wood light oak	<b>AZ HE KVD</b>	192
	<b>Stainless steel oil pan for vinegar and oil bottles</b> suitable for pull-outs Dimensions: W: 236 mm D: 146 mm H: 15 mm	<b>AZ OEW</b>	32

## Solid oak design interior organization

	<b>Cutlery organisation system, solid oak design</b> <b>Segment insert for drawers</b> For 55.5 cm carcass depth / Carcass depth 61 cm Material solid oak Flat parts / shelves MDF oak veneered, thickness 3 mm, frame thickness 8 mm Upper edges straight, edges slightly chamfered, corner joints wooden dowels Surfaces, transparent dull matt lacquered Dimensions: Without shelf W: 284 mm H: 52 mm D: 473 mm	<b>BESM-SE</b>	38
	<b>Foil dispenser for drawers</b> Incl. 2 aluminium tear-off plates with finger hole Dimensions: W: 152 mm H: 52 mm D: 473 mm	<b>BESM-FA</b>	82

# Solid oak design interior organization

		Order no.	Price
	<p><b>Knife block for drawers</b>            Dimensions:            W: 165 mm            H: 52 mm            D: 473 mm</p>	<b>BESM-MB</b>	50
	<p><b>Spice rack, three levels for drawers</b>            Dimensions:            W: 165 mm            H: 52 mm            D: 473 mm</p>	<b>BESM-GS</b>	43
	<p><b>Small-parts sliding element, two-piece for drawers</b>            Consisting of frame with unit,            unit movable            Frame without shelf, insert with shelf            Dimensions:            W: 164 mm            H: 52 mm            D: 473 mm            Pull-out divisions, solid oak design            For 55.5 cm carcase depth / Carcase depth 61 cm Material solid oak Flat parts / shelves            MDF oak veneered, thickness 3 mm, frame thickness 8 mm, upper edges straight,            edges slightly chamfered, corner joints wooden dowels, surfaces, transparent dull matt            lacquered</p>	<b>BESM-KTS</b>	28.80
	<p><b>Oak wooden tray clear lacquered for drawers</b>            Small version            W: 79 mm            H: 50 mm            D: 160 mm</p>	<b>OP HS 1</b>	16
	<p><b>Oak wooden tray clear lacquered for drawers</b>            Large version            W: 79 mm            H: 50 mm            D: 297 mm</p>	<b>OP HS 2</b>	26.70
	<p><b>Segment insert for pull-outs</b>            Dimensions:            W: 285 mm            H: 140 mm            D: 473 mm            Without shelf            Container divisions, solid oak design            For 55.5 cm carcase depth            / Carcase depth 61 cm Material solid oak            Flat parts / shelves MDF oak veneered, thickness 3 mm, frame thickness 7 mm,            upper edges straight, edges slightly chamfered, corner joints wooden dowels,            surfaces, transparent dull matt lacquered            2 finger holes 100 x 18 mm below full surface glued with anti-slip mat</p>	<b>AZSM-SE</b>	59
	<p><b>Container for pull-outs</b>            Dimensions:            W: 112.5 mm            H: 151.5 mm            D: 225 mm</p>	<b>AZSM-AE 11-22</b>	38
	<p>Dimensions:            W: 225 mm            H: 151.5 mm            D: 225 mm</p>	<b>AZSM-AE 22-22</b>	43

# Solid oak design interior organization

Price

Order no.



## Container for pull-outs

Dimensions:  
W: 112.5 mm  
H: 151.5 mm  
D: 450 mm

Dimensions:  
W: 225 mm  
H: 151.5 mm  
D: 450 mm

**AZSM-AE 11-45**

50
















**AZSM-AE 22-45**

62



# Cutlery organisation system, solid oak design

Carcase depth 55.5 cm (standard)

 <p><b>width 30 cm SET 1</b> 1 x BESM-KTS</p> <p>Order no. <b>BESM-KTS</b></p> <p>Price <b>28,80</b></p>	 <p><b>width 30 cm SET 2</b> 1 x BESM-MB</p> <p>Order no. <b>BESM-MB</b></p> <p>Price <b>50</b></p>	 <p><b>width 30 cm SET 3</b> consisting of 2 x OP HS 1 2 x OP HS 2</p> <p>Order no. <b>BE H_LB 30 S3</b></p> <p>Price <b>82</b></p>
 <p><b>width 40 cm SET 1</b> consisting of 1 x BESM-SE</p> <p>Order no. <b>BESM-SE</b></p> <p>Price <b>38</b></p>	 <p><b>width 40 cm SET 2</b> consisting of 4 x OP HS 1 4 x OP HS 2</p> <p>Order no. <b>BE H_LB 40 S2</b></p> <p>Price <b>163</b></p>	 <p><b>width 40 cm SET 3</b> consisting of 1 x BESM-FA 2 x OP HS 1 2 x OP HS 2</p> <p>Order no. <b>BE H_LB 40 S3</b></p> <p>Price <b>163</b></p>
 <p><b>width 45 cm SET 1</b> consisting of 1 x BESM-SE</p> <p>Order no. <b>BESM-SE</b></p> <p>Price <b>38</b></p>	 <p><b>width 45 cm SET 2</b> consisting of 1 x BESM-GS 1 x BESM-KTS</p> <p>Order no. <b>BE H_LB 45 S2</b></p> <p>Price <b>72</b></p>	 <p><b>width 45 cm SET 3</b> consisting of 1 x BESM-KTS 2 x OP HS 1 2 x OP HS 2</p> <p>Order no. <b>BE H_LB 45 S3</b></p> <p>Price <b>112</b></p>
 <p><b>width 50 cm SET 1</b> 1 x BESM-GS 1 x BESM-KTS</p> <p>Order no. <b>BE H_LB 50 S1</b></p> <p>Price <b>72</b></p>	 <p><b>width 50 cm SET 2</b> 1 x BESM-SE 1 x OP HS 1 1 x OP HS 2</p> <p>Order no. <b>BE H_LB 50 S2</b></p> <p>Price <b>78</b></p>	 <p><b>width 50 cm SET 3</b> consisting of 1 x BESM-MB 2 x OP HS 1 2 x OP HS 2</p> <p>Order no. <b>BE H_LB 50 S3</b></p> <p>Price <b>133</b></p>
 <p><b>width 60 cm SET 1</b> consisting of 1 x BESM-SE 1 x BESM-KTS</p> <p>Order no. <b>BE H_LB 60 S1</b></p> <p>Price <b>66</b></p>	 <p><b>width 60 cm SET 2</b> consisting of 1 x BESM-FA 1 x BESM-SE</p> <p>Order no. <b>BE H_LB 60 S2</b></p> <p>Price <b>118</b></p>	 <p><b>width 60 cm SET 3</b> consisting of 1 x BESM-FA 4 x OP HS 1 2 x OP HS 2</p> <p>Order no. <b>BE H_LB 60 S3</b></p> <p>Price <b>194</b></p>

Note: Illustrations show version with non-slip mats. Please order separately.

☐ = Merchandise net

# Cutlery organisation system, solid oak design

Carcase depth 55.5 cm (standard)



**width 80 cm SET 1**  
consisting of  
1 x BESM-SE  
1 x BESM-MB

Order no.

BE H LB 80 S1

Price

85



**width 80 cm SET 2**  
consisting of  
1 x BESM-SE  
2 x OP HS 1  
2 x OP HS 2

Order no.

BE H LB 80 S2

Price

118



**width 80 cm SET 3**  
consisting of  
1 x BESM-SE  
1 x BESM-FA 1 x  
BESM-GS

Order no.

BE H LB 80 S3

Price

162



**width 90 cm SET 1**  
1 x BESM-SE  
3 x OP HS 1  
3 x OP HS 2

Order no.

BE H LB 90 S1

Price

160



**width 90 cm SET 2**  
1 x BESM-SE  
1 x BESM-FA  
1 x BESM-GS

Order no.

BE H LB 90 S2

Price

162



**width 90 cm SET 3**  
2 x OP HS 1  
2 x OP HS 2  
1 x BESM-KTS  
1 x BESM-FA  
1 x BESM-MB

Order no.

BE H LB 90 S3

Price

238



**width 100 cm SET 1**  
consisting of  
1 x BESM-SE  
1 x BESM-KTS  
1 x BESM-FA  
1 x BESM-GS

Order no.

BE H LB 100 S1

Price

190



**width 100 cm SET 2**  
consisting of  
4 x OP HS 1  
4 x OP HS 2  
1 x BESM-KTS  
1 x BESM-SE

Order no.

BE H LB 100 S2

Price

229



**width 100 cm SET 3**  
consisting of  
1 x BESM-FA  
2 x OP HS 1  
2 x OP HS 2  
1 x BESM-MB  
1 x BESM-KTS

Order no.

BE H LB 100 S3

Price

238



**width 120 cm SET 1**  
consisting of  
1 x BESM-MB  
1 x BESM-GS  
1 x BESM-SE  
1 x BESM-FA  
1 x BESM-KTS

Order no.

BE H LB 120 S1

Price

237



**width 120 cm SET 2**  
consisting of  
1 x BESM-MB  
4 x OP HS 1  
4 x OP HS 2  
1 x BESM-SE

Order no.

BE H LB 120 S2

Price

250



**width 120 cm SET 3**  
consisting of  
1 x BESM-FA  
2 x OP HS 1  
2 x OP HS 2  
1 x BESM-GS  
1 x BESM-SE  
1 x BESM-MB

Order no.

BE H LB 120 S3

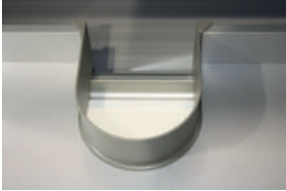











Price

291

# Accessories Base units

		Order no.	Price
	<p><b>Towel rail, chrome-plated</b>                      With 2 extendable rails                      For installation from 20 cm unit width</p> <p> <i>Note: only possible for carcass depth 55.5 cm</i></p>	<b>E-HTA2</b>	64
	<p><b>SpaceFlex® organisation system</b>                      consisting of:                      1 Framed                      5 flexible nestex® dividers                      Dimensions: (W x D x H) 520 x 472 x 130 mm</p>	<b>Z-SPACE-F 60</b>	<input type="checkbox"/> 69
	<p><b>Pet station</b>                      Installation module for unit models with side-hung doors (not for sink base units)                      Carcase width min. 40 cm, max. 60 cm                      Number of food bowls: 2x 0.45 l                      Dimensions: (W x D x H) 35.3 cm x 29.2 cm x 66.7 cm                      Colour of metal parts: silver                      Colour of plastic parts: dark grey</p>	<b>Z-HTS</b>	<input type="checkbox"/> 96
	<p><b>Built-in towel holder with 1 rail</b>                      Clean, aesthetic and discrete                      For installation behind a 38.6 cm pull-out panel, for example                      1 rail                      Rail length 45.0 cm                      Height 20.0 cm, thickness 2.0 cm                      Laminate light grey</p>	<b>HTH-1</b>	<input type="checkbox"/> 15,70
	<p><b>Aluminium base for sink base unit</b>                      With lateral and rear upstand                      (only for carcass depth 55.5 cm)</p>	<p><b>AB 40</b></p> <p><b>AB 45</b></p> <p><b>AB 50</b></p> <p><b>AB 60</b></p> <p><b>AB 80</b></p> <p><b>AB 90</b></p> <p><b>AB 100</b></p> <p><b>AB 120</b></p>	<p>24,10</p> <p>25,70</p> <p>26,90</p> <p>28,50</p> <p>39</p> <p>43</p> <p>46</p> <p>48</p>
	<p><b>Heat shield</b>                      For base units with hob on top, suitable for carcass depth 55.5 cm                      Prevents accidental contact and provides thermal insulation. To be installed on site                      A gap of approx. 20 mm is created under the bottom edge of the worktop. Safety distances specified by the appliance manufacturers must be noted without fail when planning and installing the parts. Heat shield must always be ordered for induction hobs – units with internal drawers cannot be installed in combination with induction hobs.</p>		
	Suitable for carcass width 60 cm	<b>HSB 60 -55</b>	78
	Suitable for carcass width 80 cm	<b>HSB 80 -55</b>	101
	Suitable for carcass width 90 cm	<b>HSB 90 -55</b>	109
	Suitable for carcass width 100 cm	<b>HSB 100 -55</b>	123
	Suitable for carcass width 120 cm	<b>HSB 120 -55</b>	147
	<p><b>Anti-tilting safety device</b>  <b>Mounting set for base units</b>                      Fastening set for base cabinets for screwing or gluing with glue for floor mounting, can be planned from a plinth height of 10 cm                      1 set suitable for 1 base unit</p> <p> <b>Note:</b>  <i>Mounting hardware is not included in the scope of delivery and must therefore be obtained by the customer.</i>  <i>Base units - whether standing against the wall or used in island form - must also be secured in place to prevent them from toppling over.</i>  <i>Attention: Gluing on laminate, PVC and linoleum floors is not permitted!</i>  <b>For free-standing base units, KS-U is added automatically.</b></p>	<b>KS</b>	<input type="checkbox"/> 39

## Accessories Base units

		Order no.	Price
	<b>Plastic moulded part - sink drain pipe</b> Separate, for installation on-site in drawers	<b>E-ASE</b>	18,10
	<b>FIXOL Universal set</b> Set of moulded parts for cutouts for e.g. sink base units Incl. installation instructions and mounting material 1 cover profile for cut edges	<b>FIXOL</b>	101
	<i>Important!</i> only possible in conjunction with wooden rear panel for drawer/pull-out The Universal set by Fixol can be used to prepare any drawer/pull-out as required on-site. Whether water treatment system, odour trap, sink or hob extractor, nothing is left in your way with FIXOL. The cutout is made on site once everything has been fitted. This means the drawer/pull-out is always the perfect size, and the optimum use is made of the available space. Fixol is suitable for all drawers/pullouts with a rear panel and base thickness of 16 mm.		
	<b>Metal cross-bars for base units</b> Available for carcase widths 60, 80, 90, 100, 120	<b>MT 60</b> <b>MT 80</b> <b>MT 90</b> <b>MT 100</b> <b>MT 120</b>	16,10 17,20 18,40 18,40 19,50
	<b>Metal cross-bars for base units</b> silver-coloured Supports for worktops 1.6 cm	<b>MTA 80</b> <b>MTA 90</b> <b>MTA 100</b> <b>MTA 120</b>	19,50 21,40 23 25
	<i>Planning: Additional requirement.</i> 1 cross member for carcase depths 45.5 cm/55.5 cm 2 cross members for carcase depths 70.5 cm. Profile cross section 20/25mm		
	<b>Waste bin</b>  <b>Waste bin 5.5 L</b>	<b>E-AFB5</b>	31
	<b>Individual lid for waste collector 5.5 l and 8 l</b>	<b>Z 132</b>	12,90
	<b>Waste bin</b>  <b>Waste bin 8 L</b>	<b>E-AFB8</b>	34
	<b>Organic tray for waste collector 5.5 L and 8 L</b>	<b>Z 133</b>	20,80
	<b>Waste bin</b>  <b>Waste bin 12 L</b>	<b>E-AFB12</b>	45
	<b>Individual lid for waste collector 12 l and 17 l</b>	<b>Z 134</b>	16

# Accessories Base units

		Order no.	Price
	<b>Waste bin</b>		
	<b>Waste bin 17 L</b>	<b>E-AFB17</b>	48
	<b>Organic tray for waste collector 12 l and 17 l</b>	<b>Z 135</b>	23,40
	<b>Side box for upstanding Ninka waste bin</b> available from carcass widths 80 cm	<b>E-AFSN-SB</b>	50
	<b>Dustpan set for waste collector 12 L and 17 L</b> consisting of: Dustpan Brush	<b>Z 136</b>	31
	<b>Electronic opening assistance for pull-outs Hailo Libero 3.0</b> <b>For base units from 300 mm to 1200 mm width</b> The new Hailo sensor opener for the automatic and convenient opening of all waste separation systems with front integration and all pull-out systems. Easy operation via foot sensor and/or voice control. For base units from 300 mm to 1200 mm width No inadvertent opening Installation at the front of the unit base Can be retrofitted easily Low-voltage device (5 V), with USB-C plug Power supply via conventional plug sockets 110 - 230 V, with 2 m cable USB-C / USB plug incl. 5 V, 2 A power supply unit and international adapter Easy operation with new laser foot sensor and/or voice control Settings and configurations via web browser Integrated LED location lighting, can be dimmed, can be switched off Push-out strength configurable, sensor sensitivity configurable Intelligent control, detects obstacles thanks to slip coupling Dripping water protection in accordance with IP 21 certification With European, British, Australian and North American certifications Compatible with Alexa voice control systems Developed and manufactured in Germany Dimensions: 157 mm x 300 mm x 33 mm (W x D x H), as per Libero 2.0 WEEE-Reg.-No.: DE 60802808	<b>EL-AZ</b>	291
	<b>Suspension fittings for base units / tall units</b> Set suitable for 1 carcass consisting of: 1 hanger left 1 hanger right 1 white cap for hanger left 1 white cap for hanger right 2 wall panels 120 x 120 mm	<b>SET-SAH</b>	45
	<i>The fittings for wall-mounting must be provided by the customer! The units must be mounted directly on the wall. Suitable hardware (screws and raw plugs) for mounting the units on the wall must be decided and procured by the customer. The load-bearing capacity and nature of the wall, as well as the precise type of attachment must always be decided on site by a structural engineer or correspondingly authorized person. We cannot accept any liability for property damage or personal injury due to improper installation or inadequate building strength.</i>		

# Accessories Base units

		Order no.	Price
	<b>Heat shields</b> to protect fronts adjacent to oven silver-coloured price per pair	HP/C	17,10
	<b>Waste bin, round</b> 12 L, chrome-plated housing For installation from 40 cm base unit width upwards	Z 3	53
	<b>Bottle basket, chrome-plated</b> For pull-out trolley Size (W x H x D) 192 x 306 x 410 mm	Z 11	65
	<b>Pivoting mechanism for all-purpose slicer</b> For 45 cm bread slicer unit	Z 150-45	155
	For 50 cm bread slicer unit	Z 150-50	155
	For 60 cm bread slicer unit	Z 150-60	155
	<b>Cushioned self-closing mechanism for "Le Mans" carousel shelves</b>   <i>Important!</i> Version L = left suitable for unit types in the version L=left Version R = right suitable for unit types in the version R=right	Z 142	R/L 41
	<b>Electric all-purpose slicer Ritter</b> For installation in 60 cm wide units Right-hand slicing, all-metal finish, silver-metallic Electrolytically polished serrated slicer blade 17 cm diameter - Variable thickness of slices up to approx. 14 mm - 2-finger switch system child safety device Single and continuous operation Automatic folding lock when slice thickness is set - Polished stainless steel collection tray for slices Angled holder for finger protection and remains holder Mounting fixture locks automatically - VDE / GS mark, protection class 2, CE - 230 V, 65 V, KB 5 min Appliance dimensions: folded in mm (H/W/D) 73/345/370, weight: 1 item 4.3 kg   <i>All-purpose slicer only for base units width 60 cm</i> Series XL Attention: In conjunction with the E-AES72ER, the base unit is equipped with a metal cross bar at the factory. Only possible in upper drawers 126 mm and 600 mm wide.	XL E-AES72ER	613
	<b>Electric all-purpose slicer Ritter</b> for installation in 50 or 60 cm wide units Tall fitting, for example for handleless kitchens, extra-thick worktops Right-hand slicing, all-metal finish, silver-metallic Electrolytically polished serrated slicer blade 17 cm diameter - Variable thickness of slices up to approx. 14 mm - 2-finger switch system child safety device Single and continuous operation Automatic folding lock when slice thickness is set - Polished stainless steel collection tray for slices Angled holder for finger protection and remains holder Mounting fixture locks automatically - VDE / GS mark, protection class 2, CE - 230 V, 65 V, KB 5 min Dimensions: height: 75 mm width: 390 mm depth: 365 mm (closed)   <i>Note: only for upper drawers in handleless base units</i> Only for GL series	GL E-AES72SR-H	683



**Metal cross-bars for base units**

**E-THUM60**

7,10



**Note:**  
Necessary for subsequent installation of the all-purpose slicer  
Only for XL series



**Pantry Box for storing fruit and vegetables**

**P-BOX 60**

349

Insert for 60 cm wide pull-outs , depth 55.5 cm, height 38.6 cm, colour: white consisting of:

- 1 plastic tub
- 1 sliding cover for plastic tub (safety glass)
- 1 plastic grid insert
- 1 wooden grid insert
- 1 multi tray with handle



With XL and GL with vertical grip ledge, the Box can be used in a pull-out panel height of 321 mm  
With GL with horizontal grip ledge, the Box can be used in a pull-out panel height of 355 mm  
**Important:**  
- Not possible for internal pull-outs

A number of factors must be observed when storing fruit and vegetables. Fruit and vegetables should always be stored separately from one another.

**FRUIT:**

The following fruits can be stored in the Pantry Box: pineapples, clementines, grapefruit, limes, oranges, physalis, lemons

The following fruits can also be stored in the Pantry Box, but only individually and not in combination, as they give off ethylene\*: apples, bananas, pears, kiwi, mangoes, melons, nectarines, peaches

**VEGETABLES:**

The following vegetables can be stored in the Pantry Box:

aubergines (eggplants), cucumbers, potatoes, garlic, pumpkins, sweet peppers, pepperoni, courgettes, onions

The following vegetables can also be stored in the Pantry Box, but only individually and not in combination, as they give off ethylene\*: tomatoes

Other types of fruit and vegetables must be stored in a cool place and therefore are better off in the fridge.

\*(Ethylene is a gas which is given off by fruit and vegetables as they ripen. In other words, these types of fruit and vegetables make others ripen more rapidly and hence spoil more quickly.)



**Hailo Micro Garden**

suitable for cultivating microgreens in the kitchen

Insert for 60 cm wide pull-outs , depth 55.5 cm, height 32.1 cm, colour: white

The system consists of:

- 1 Farming Container for the pull-out
- sliding container cover
- lighting panel, app controlled, including mains adapter
- plastic rack
- 4 planters with covers
- 4 strainers
- Planter covers (4)
- Seed mats, starter set, 4 pieces
- App to download
- Installation accessories

**F-BOX 60**

1066







With XL and GL with vertical grip ledge, the Box can be used in a pull-out panel height of 321 mm  
With GL with horizontal grip ledge, the Box can be used in a pull-out panel height of 355 mm  
**Important:**  
- Not possible for internal pull-outs












# Accessories Base units

		Order no.	Price
	<b>Hailo AS Tandem waste bin</b> Number of containers: 2 Volume: 2 x 15 l Color: dark gray suitable for units with hinged doors from a width of 30 cm	<b>HAST 15 15</b>	107
	<b>Plinth foot</b> stainless steel look, aluminium 50 x 50 mm, square Height adjustment + 10 mm		
	For plinth height 10 cm For plinth height 15 cm	Unit price <b>Z 102-10</b> Unit price <b>Z 102-15</b>	52 55
	<b>Cleaning product basket, chrome-plated</b> for fixing to the inside of the door or on the carcass side panel Size (W x H x D) 305 x 110 x 100 mm	<b>Z 8</b>	24,10
	<b>Set spacer strips</b> for adding to internal drawers and internal pull-outs with unit models with hinged doors without wide angle hinges Finish: silver-coloured plastic Thickness 2.5 cm, 2 items To be installed on site Note: Width-reduced internal drawers and internal pull-outs to be ordered separately Example: Carcase width 60 cm - wide internal drawers planned for carcase width 55 cm	<b>DLI</b>	52
	<b>Variable width of drawers/pull-outs Price calculation:</b> Article SA50BU must be taken into account. Extra charge refers to next largest element.	<b>SA50BSK</b> <b>SA50BAZ</b>	48 57
	<b>internal drawer</b> With cushioned self-closing mechanism and full pull-out Incl. guides with 1 spacer strip to compensate for the hinge for installation behind doors for base and tall cabinets The width of the inner drawer is 2.5cm below the nominal size	<b>E-ISK4555D</b> <b>E-ISK5055D</b> <b>E-ISK6055D</b>	165 167 171
	<b>Internal pull-out</b> <b>with 1 spacer strip to compensate for the hinge</b> for installation behind doors for base and tall units The width of the internal pull-outs is 2.5 cm narrower than the nominal dimension.	<b>E-IAZ4555D</b> <b>E-IAZ5055D</b> <b>E-IAZ6055D</b>	227 230 234
	<b>Height compensation panel for dishwashers</b> 1 stainless steel panel 6 cm high with screws for working height 92 cm for height compensation for fully integrated standard dishwashers	<b>Z 51-45</b> <b>Z 51-60</b>	43 43
	<b>Cylinder lock for door</b> Installed		
	Door at bottom, keyed differently Door at top, keyed differently Door at bottom, keyed alike Door at top, keyed alike	<b>SA 91010 U</b> <b>SA 91010 H</b> <b>SA 91010 GU</b> <b>SA 91010 GH</b>	77 77 77 77

## Accessories Base units

		Order no.	Price
	<p><b>Spacer strip for planning between carcass and panel</b> Thickness approx. 2 mm, length 2208 mm, natural-coloured.</p>	<b>DLW</b>	7,20
	<p><b>Metal profile as steam guard for raised dishwashers</b> Stainless steel</p> <p>for 60 cm width for 45 cm width</p>	<p><b>DS GSP 60</b> <b>DS GSP 45</b></p>	<p>112 109</p>
	<p><b>Frame element for hanging recycling bags</b> including cover and 1 recyclable pocket made of reinforced plastic material Fits on pull-out base Frame colour finish: art pepper for featuring front pull-outs from 71.1 cm - carcass height of 71.5 cm from 40 cm carcass width: 1 x WR RE frame element set 60 cm carcass width can take 2 WR RE frame element sets</p>	<b>WRRE</b>	125
	<p><b>Multifunction box for FREEMOBILE</b> with lid for FREEMOBILE for hooking into top cross stay Also suitable for hooking onto kitchen fronts in a thickness of up to 22 mm. Do not use in conjunction with finger pulls. Colour finish: grey Volume: 4.2 l Dimensions: 170 x 227 x 172 mm</p>	<p>REGISTERED COMMUNITY DESIGN</p> <p><b>FMOBMBOX</b></p>	19.50

# Accessories

		Order no.	Price	
	<p><b>Extra charge TIP-ON BLUMOTION for LEGRABOX</b> The new movement technology by Blum for handleless furniture combines the opening convenience of TIP-ON with the soft, quiet closing of BLUMOTION.</p> <p> <b>not available for</b>                      - base unit widths &gt; 120 cm e.g. for U 180 78 55 02                      - internal drawers and internal pull-outs                      - internal drawers in combination with carriers                      - pull-out front heights 77.6/84.1 cm                      - all pull-out fronts &gt;646 mm are not available with TIP ON</p> <p><b>TIP-ON for drawers and pull-outs from 30 - 120 cm width</b>                      Extra charge per drawer/pull-out                      With synchronisation axis from 40 cm width                      For carcass depths 34 cm, 45.5 cm and 55.5 cm                      Installed in the factory                      For 70.5 cm carcass depth</p>	<b>MP-TIPON60-1</b>	53	
		<b>MP-TIPON60-2</b>	72	
	<p><b>Carrier for internal drawer for LEGRABOX system</b> Not available in conjunction with handle <b>N 700</b> with a guard for the front of the internal drawer</p>	<b>MIS-LB</b>	19	
	<p><b>Set of "cuisio FLEX" organisation frames</b> Consisting of 2 pieces = 1 set Colour: corner pieces aluminium grey, middle part graphite translucent Two-dimensional telescopic adjustment using clips Easy adjustment at the touch of a finger, can be used with any width and depth Stable thanks to non-slip legs Dimensions: height 129 mm, width/depth 236 - 386 mm</p>	<b>ZAO-ORG</b>	82	
	<p><b>Legrabox side stabilization for on-site installation</b> suitable for all body depths for cutting to length</p>	<b>E-LBSTAB</b>	27	
<b>Support legs</b>				
	<p><b>Support, square</b> With concealed mount flush with the corner, height 705 mm, 60 x 60 mm, for ASTD models Height can be adjusted by 10 mm stainless steel-coloured</p>	Unit price <b>STFE70/5</b>	136	
	black	Unit price <b>STFES70/5</b>	136	
	<p><b>Support, square</b> with concealed mount flush with the corner, Available height of 650-999 mm 100 x 100 mm, 10 mm height-adjustable Available in all decors from decor group K</p>	 <b>Important! Please state the exact height.</b>	<b>STFE00-100</b>	153
	<p><b>Support system, square</b> Dimensions of support leg: 90 x 90 mm Width <u>900 mm</u>, height <u>705 mm</u> <u>Support system, mitred and glued</u> <u>Available in all decors from decor group K</u></p>	Unit price <b>STFES</b>	487	
	as above, but width from 901 to 1180 mm	per 10 cm Width <b>STFES00</b>	54	

# Support legs

Order no.

Price

**Must be planned:**

1 central brace in worktop decor for stability  
 To be fitted under the table top  
 Underside with thick edge  
 Min. length minus 180 mm in relation to table top



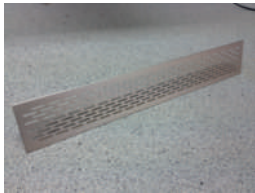
Note: Table top must be ordered separately (only APD and AP5D)

per 10 cm  
Width

**STFES-MS**

11,60

## Ventilation grille



**Ventilation grille for top cover 50 x 8 cm**

Aluminium, anodised stainless steel-coloured

Unit price

**Z 101**

19,20



**Plinth ventilation grille 36.7 x 7.8 cm**

Finish: laminate  
 Matching carcass colours

Unit price

**SL**

14,30

## Consoles/shelf supports



**Shelf support**

Finish: stainless steel-coloured  
 for fixing shelves up to 25 cm depth  
 (thickness 8-50 mm) to walls  
 Max. distance between supports 45 cm  
 The shelf bracket adds 6 mm.  
 Subtract this value from the final dimension of the shelf.  
 Maximum load: 16 kg



Unit price

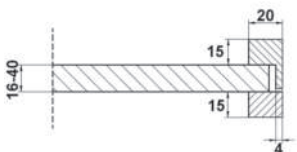
**Z 130**

39



**Shelf bracket**

For mounting on the wall  
 2-part aluminium profile black matt  
 suitable for shelves of 1.6 cm - 4.0 cm thickness,  
 max. depth 20 cm  
 Depending on width, 2 to 6 holes need to be  
 drilled in the shelves  
 Incl. installation instructions and mounting  
 material



60 cm wide

Unit price

**RBH 60**

77

90 cm wide

Unit price

**RBH 90**

96




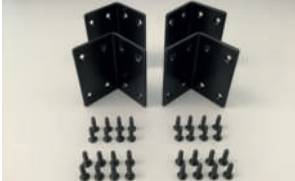
120 cm wide

Unit price





**RBH 120**

115



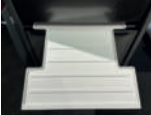


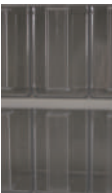


## Accessories Worktop and aperture design

		Order no.	Price
	<p><b>Cereal dispensers with stands</b>                      Special functions                      Suitable for muesli, rice, cereals, sweets, nuts, etc.                      The dispenser can be removed for use at the table                      Crumb-free, simple portioning                      The aroma protection cap protects the foodstuffs and ensures a clean work surface                      Easy cleaning                      Not suitable for dishwashers                      Dimensions and details:                      diameter: 15 cm, height 42.5 cm                      Volume: 1.5 l</p>		
		Unit price	<b>CESP2</b> 86
	<p><b>real wood holder for cereal dispenser</b>                      W: 120 mm                      D: 162 mm                      H: 300 mm</p> <p>Finish: black ash                      Finish: light oak</p>		
		Unit price	<b>CESP-HH</b> 157
		Unit price	<b>CESP-HHE</b> 165
	<p><b>Socket strip</b>                      EVOLine® V Dock / USB-C                      With fixed mains power cable 2.5 m long and separately enclosed plug.                      2 sockets VDE and USB-C charger                      Silver anodised profile                      Length: 154 mm                      Width: 69 mm                      Depth 69 mm</p>	<b>NEW</b>	
		Unit price	<b>EVO-VDC</b> 114
	<p><b>Connection bracket set</b>                      Set comprising                      4 connection brackets incl. screws                      for fitting worktops / panel constructions                      Colour: black, powder coated</p>		
		Unit price	<b>VBW4-SET</b> 56





## Accessories Wall units / dresser units

	<p><b>Spice rack, chrome-plated</b></p> <p>With 12 spice jars                      without spice jars</p>		
		Unit price	<b>Z 5</b> 84
		Unit price	<b>Z 6</b> 33
	<p><b>Glass holder</b>                      1 row, tube line system, tube diameter 6 mm                      Stainless steel, polished                      Width 31.6 cm                      Height 4.8 cm                      depth 10 cm</p> <p> suitable for shelves from a depth of 36.1 cm and unit models from a depth of 45.5 cm</p>		
		Unit price	<b>Z-GS</b> 28.80
	<p><b>Glass holder</b>                      for 3 glasses side by side                      Surface: RAL9005 deep black, fine structure                      Size (W x H x D) 95 x 25 x 290 mm</p>	<b>NEW</b>	
		Unit price	<b>Z-GHN 3</b> 51

# Accessories Wall units / dresser units






		Order no.	Price
	<b>Glass holder</b> for 3 glasses behind one another Surface: RAL9005 deep black, fine structure Size (W x H x D) 350 x 25 x 120 mm	<b>NEW</b>	
	Unit price	<b>Z-GHH 3</b>	40
	<b>Vapour protector</b> Size: 339 x 130 mm, finish: metal, 1 set = 2 each For protecting the sides of wall units fitted next to an extractor hood		
	Unit price	<b>Z 104</b>	46
	<b>DRIP PROTECTION II water protection tray</b> for use under washing machines and driers can be pulled out from the front for drip protection during filter changes etc. suitable for 60 cm wide appliances Material: plastic	<b>NEW</b>	
	Unit price	<b>DRIP 60</b>	28.80
	<b>Plate rack drainer set</b> consisting of: Rack, drip tray, frame		
	Suitable for unit width 60 cm	Unit price	<b>Z 149-60</b>
	Suitable for unit width 90 cm	Unit price	<b>Z 149-90</b>
			91
	<b>Vapour protector for raised dishwashers</b> Finish: metal to protect the fronts above		
		Unit price	<b>WSB-45</b>
		Unit price	<b>WSB-60</b>
			11
	<b>Container set, 6-part</b> For installation in wall units White container frames, transparent containers		
	Unit price	<b>Z 7</b>	64
	<b>Middle shelf support for wall units 78 cm high</b> From width 80 cm Aluminium-coloured, with 3 shelf supports		
	Unit price	<b>MB S78</b>	27.80
	<b>Cutout for 1 lamp fixture</b> in wall unit bottom shelf 68 mm hole diameter Please order lamps and converter separately		
	Unit price	<b>AFLOHU-1</b>	77
	2 cutouts	Unit price	<b>AFLOHU-2</b>
			118
3 cutouts	Unit price	<b>AFLOHU-3</b>	156

## Accessories Wall units / dresser units

		Order no.	Price
	<b>Cutout for 1 lamp fixture</b> in wall unit top shelf 68 mm hole diameter Please order lamps and converter separately	Unit price <b>AFLOHO-1</b>	77
	2 cutouts	Unit price <b>AFLOHO-2</b>	118
	3 cutouts	Unit price <b>AFLOHO-3</b>	156
	<b>Container made of lead crystal</b> smooth front, crystal clear Contents 750 ml Dimensions (W x D x H) 115 x 185 x 110 mm (with handle)	<b>E-KNRGLASS</b>	50
	<b>Pull-out shelf with guide rails</b> With locking function, full pull-out „push to open“, shelf from decor group K For carcass width 45 cm, 50 cm, 60 cm For carcass width 80 cm, 90 cm for carcass depths 45.5 cm and 55.5 cm  <b>Important:</b> When installing in units with hinged doors always take wide angle hinges <b>SA-90155E3</b> into consideration.	<b>TAB-AZ45 55</b>	220
		<b>TAB-AZ45 45</b>	220
		<b>TAB-AZ50 55</b>	225
		<b>TAB-AZ50 45</b>	225
		<b>TAB-AZ60 55</b>	234
		<b>TAB-AZ60 45</b>	234
		<b>TAB-AZ80 55</b>	282
		<b>TAB-AZ80 45</b>	282
		<b>TAB-AZ90 55</b>	298
		<b>TAB-AZ90 45</b>	298

## Accessories Wall units / Tall units

Power-assisted lift-up fittings must comply with CE regulations. The kitchen planner and fitter are responsible for ensuring compliance.

	<b>Extra charge for preparing power-assisted lift-up fittings</b> Hole in back panel, left and right sides with hole	<b>MP-VEK</b>	51
	<b>Motor for power-assisted lift-up fittings</b> suitable for articles HL... and HGLD... Note: To be installed on site  with 2 motors	<b>SET-E-T-HL</b> <b>SET-E-T-HL 120</b>	414 827
	<b>Motor for power-assisted lift-up fittings</b> suitable for articles HFL..., HFLD.. and HFLMD.. Note: To be installed on site	<b>SET-E-T-HFL</b>	414
	<b>Motor for power-assisted lift-up fittings</b> Suitable for all articles with fittings for lift-up doors Note: To be installed on site	<b>SET-E-T-LTG 60</b>	414
	<b>Motor for power-assisted flap fittings</b> Available for wall units with flap doors Note: To be installed on site  <b>Important!</b> Available from unit width 80 cm	<b>SET-E-T-HK</b>	414



## Accessories Wall units / Tall units

Power-assisted lift-up fittings must comply with CE regulations. The kitchen planner and fitter are responsible for ensuring compliance.

Order no.

Price



**Must be planned: Connecting set for 1-3 units**  
 consisting of:  
 Power pack 100 W (all countries)  
 Power cable 200 cm long  
 Power pack bracket for wall-mounted  
 Cables 2 x 1.5 mm<sup>2</sup>, packed separately 6 m long  
 SERVO-DRIVE installation and operating instructions

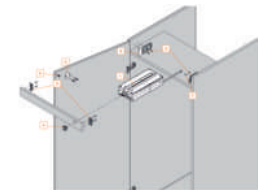
**SET-E-A**

202

**As above, but with power cable for Switzerland** consisting of: Power pack 100 W (all countries) Power cable 200 cm long Power pack bracket for wall-mounted Cables 2 x 1.5 mm<sup>2</sup>, packed separately 6 m long SERVO-DRIVE installation and operating instructions

**SET-E-A-CH**

202



Drive unit

### SERVO-DRIVE flex

for refrigerators and fully integrated dishwashers for installation on-site, please order panel material separately.  
 SERVO-DRIVE flex ensures easy opening of refrigerators, freezers and fully integrated dishwashers, making it the perfect solution for almost any refrigerator and freezer. The automatic self-closing feature that is activated in the event of the refrigerator accidentally being opened ensures that it is instantly closed again without delay. Thus SERVO-DRIVE provides electronic opening assistance for kitchens with standard units.

**SET-SDF**

499



SERVO-DRIVE switch

### SERVO-DRIVE flex consists of:

Drive unit with cam valve  
 Wireless receiver,  
 SERVO-DRIVE switch  
 Mounting material  
 Mains unit

## Accessories Tall units



### Storage set for larder unit

Carrier element with 4 separate storage containers (1.2 litres)  
 with grey lid and with 2 transparent open storage containers with slot-in dividers

**Z 22**

208

### jars (1,2 Litre) for depot set

**Z22VRD12**

24,20



### Wire basket for larder unit

30 cm wide  
 45 cm wide

**Z 30**

43

**Z 105**

55



### wooden shelf with chrome-plated, square rail for larder unit

30 cm  
 45 cm

**Z 139**

84

**Z 140**

89





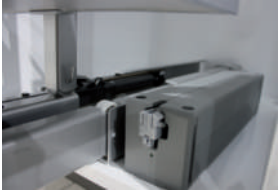
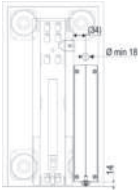




### Wooden shelf with chrome-plated square rail for angled larder unit 37.2° unit width 25 cm

**Z 144TP**


R/L

91

## Accessories Tall units

			Order no.	Price
	<b>Glass shelves for height-adjustable wire baskets</b> Clear glass			
	Suitable for models (L)GV30.., GVD30..	Unit price	<b>Z 99-30</b>	13,70
	Suitable for models (L)GV45..	Unit price	<b>Z 99-45</b>	19,20
	<b>Plastic tray for height-adjustable wire baskets and wooden shelves with square rails (base units / tall units)</b> champagne colour			
	Suitable for models (L)GV30.., GVD30..	Unit price	<b>Z 103-30</b>	10,70
	Suitable for models (L)GV45..	Unit price	<b>Z 103-45</b>	11,90
  	<b>Electrical opening system for larder unit „pull-out larder unit“</b> in widths 30 and 45 cm On site installation Scope of delivery Mains unit Connection cable Installation instructions			
		Unit price	<b>EL-GV</b>	659
	<b>TurnMotion II rotating shelf</b> For carcass width 60 cm For installing behind a tall unit door Door minimum dimension: Height 51.6 mm Carcass depth min. 55.5 cm consisting of: 2 fastening rails 38.4 cm 2 rotating shelves 44 x 44 cm with square chrome-plated rail and wooden shelves 4 support arms			
		Unit price	<b>TM 60-2</b>	306
   <div style="background-color: #e0e0e0; padding: 5px; margin-top: 5px;"> <b>Note:</b>  <i>for optimising gaps between appliances</i>  <i>The entire aperture height can be used for appliances, provided support brackets or metal shelves are used. for example, GAW-SET.</i>  <i>On site installation</i>  <i>Please state both appliances.</i> </div>	<b>optional accessories:</b> <b>Appliance support bracket set including fixing materials</b> consisting of: 2 appliance support brackets in steel to support appliances			
		Unit price	<b>GAW-SET</b>	29,80
	<b>Baking tray holder set</b> Consisting of 2 units, for carcass width 60 cm for installing behind a tall unit door below or above appliance apertures Carcass depth min. 55.5 cm Finish: chrome-plated Incl. fixing material Height per unit: 12.5 cm		<b>Z 152 BBE</b>	53







## Accessories Tall units

		Order no.	Price
	<b>Adjustable metal shelf</b> Colour finish: graphite Available for carcase widths: 60 cm available for carcase depths of 34 cm, 45.5 cm, 55.5 cm Dimensions (W x D x H)		
	566.5 x 304.5 x 12 mm	<b>MB 60 34</b>	51
	566,5 x 414,5 x 12 mm	<b>MB 60 45</b>	61
	566,5 x 505 x 12 mm	<b>MB 60 55</b>	62


## Accessories Home Economics

	<b>Metal frame for holding bottle crates</b> suitable for unit types in 60 cm width Finish: metal, anthracite incl. mounting and fixing material	<b>MHG 60</b>	41
	<b>Metal shoe racks with raised back edge</b> suitable for unit types in 60 cm width Finish: metal, anthracite incl. mounting and fixing material	<b>MBS 60</b>	30
	<b>Hailo Laundry basket</b> Hailo Laundry Area 60 cm laundry basket Hailo laundry basket as stand-alone module Material: plastic Colour: white Dimensions: 520 x 462 x 304 mm Volume: 41 l  <i>The laundry basket is sufficient for one washing machine load.</i>	<b>HLA-EWK</b>	74
	<b>Utensils container-Set</b> consisting of: 2 x utensils container, white 1 wall-mounting for utensils container, dark gray	<b>HLA-UB</b>	54
	<b>Mounting rail</b> 1 set of attachment rails, anthracite	<b>HW-BL100</b>	39
	<b>Storage surface with rail</b> 1 large 3-side tray with rail, anthracite	<b>HW-ABLR</b>	44
	<b>Carrying box</b> 1 carrying box for cleaning products, with profile handles, anthracite	<b>HW-TB</b>	61




## Accessories Home Economics

	Order no.	Price
 <p><b>Hook rail with 5 hooks</b> 1 hook profile with 5 utensil hooks, anthracite</p>	<b>HW-HLE5</b>	25
 <p><b>Hook rail with 5 hooks</b> 1 hook profile with 5 utensil hooks, laterally screw-mounted, anthracite</p>	<b>HW-HLS5</b>	23
 <p><b>Holder</b> Holder for vacuum cleaner hose or PET storage pocket (for screwing on), anthracite</p>	<b>HW-HS</b>	23
 <p><b>Utensils box</b> Utensils box, e.g. for storing towels, cleaning cloths, etc. (for screwing on), anthracite</p>	<b>HW-UB</b>	54
 <p><b>Hanging shelf</b> for shoes (W x H x D) 448 x 110 x 77 mm Finish: metal, anthracite</p> <p><b>Note:</b> For mounting on the carcass side or inside of the front (possible from a door width of 60 cm)</p>	<b>EHTS 60</b>	45
 <p><b>rail for e-shelf</b> Finish: laminate, anthracite incl. mounting and fixing material On site installation Dimensions: 1114 x 24 x 38 mm</p>	<b>RB 60</b>	27,20

## Accessories Push to open

<p><b>Opening element for door without handle („push to open“ fitting)</b> Separate, for installation on-site long version</p>	<b>Z 91OSL</b>	24,80
 <p><b>Opening element for door without handle („push to open“ fitting)</b> consisting of: 1 fitting with attachments</p> <p>2 hinges 107° without spring</p> <p>3 hinges 107° without spring</p>	<b>Z 91L-2</b>	27,90
	<b>Z 91L-3</b>	32



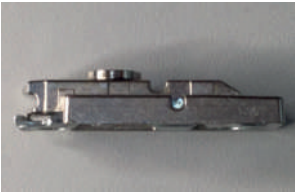

# Accessories Push to open

		Order no.	Price
	<b>Opening element for door without handle („push to open“ fitting)</b> consisting of: 1 fitting with attachments		
	2 wide angle hinges 155° without spring	<b>Z 151</b>	33
	3 wide angle hinges 155° without spring	<b>Z 151-3</b>	45
	<b>Opening element for flap door without a handle with wall units („push to open“ fitting)</b> drilled into the structural shelf Not available for fold-lift, swivel-lift and lift-up fittings		
		<b>MP-PTOHK</b>	61
	<b>Opening element for flap door without a handle with tall cabinets („push to open“ fitting)</b> screwed onto the construction shelf Not available for lift-up fittings To be installed on site	<b>MP-PTOGK</b>	25.40
	<b>Extra charge for „push to open“ fitting drilled into the carcass side</b> Price per door	<b>NEW</b>	
		<b>MP-POS</b>	14.10
	<b>Extra charge for „push to open“ fitting drilled into the carcass side</b> including hinge change from 107° to 155° -by factory-	<b>NEW</b>	
2 hinges 155° without spring	<b>MP-WPS02</b>	27	
3 hinges 155° without spring	<b>MP-WPS03</b>	34	
4 hinges 155° without spring	<b>MP-WPS04</b>	40	
5 hinges 155° without spring	<b>MP-WPS05</b>	46	
6 hinges 155° without spring	<b>MP-WPS06</b>	54	
7 hinges 155° without spring	<b>MP-WPS07</b>	60	
8 hinges 155° without spring	<b>MP-WPS08</b>	66	
9 hinges 155° without spring	<b>MP-WPS09</b>	72	
10 hinges 155° without spring	<b>MP-WPS10</b>	79	

## Accessories Hinges

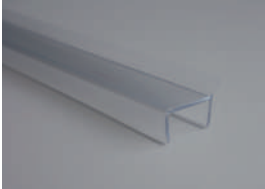


		Order no.	Price
	<b>Clip hinge 107° with integrated soft-close mechanism</b> Without mounting plate	<b>CS 107</b>	16,90
	<b>Clip hinge 107°</b> Without spring, without mounting plate	<b>CS107-OF</b>	16,90
	<b>Clip hinge 87° with integrated soft-close mechanism</b> Without mounting plate	<b>CS 87</b>	18,30
	<b>Guiding hinge</b> for over-high fronts with fixed door mounting (incl. template and installation instructions)	<b>FS-FTM</b>	51
	<b>Cover cap for clip hinge 107° hinge arm ( 10 items )</b>	<b>CS-AA</b>	13
	Cover cap for clip-hinge 107° hinge top (10 pieces)	<b>CS-AT</b>	13
	<b>Opening angle limiter 87° for</b> Clip hinge 107°, quantity: 10 items	<b>CS-OEW</b>	22,20
	<b>Opening angle limiter 110° for wide angle hinges 155°</b> Quantity 5 pieces	<b>CS155OEWID</b>	10,50
	<b>Opening angle limiter 92° for wide angle hinges 155°</b> Quantity 5 pieces	<b>CS155OEWID92</b>	10,50
	<b>1 pair 124° opening angle limiters for flap door units (HL...)</b> Quantity 2 pieces	<b>KL-OEW124</b>	7,20


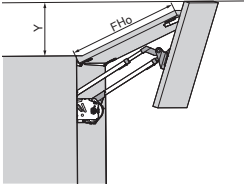


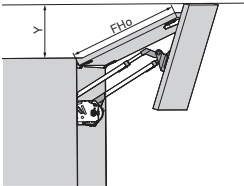





# Accessories Hinges

		Order no.	Price
	<p><b>Clip hinge 155°</b></p> <p>With integrated soft-close mechanism, without mounting plate</p>	<b>CS155-ID</b>	22,20
	<p><b>Clip hinge 37° for angled units</b></p> <p>With integrated soft-close mechanism, without mounting plate</p>	<b>CS 37</b>	16,90
	for clip hinges 87°, 107° and 155° (1 piece) Height 11 mm	<b>CS-MP3</b>	11,80
	for clip hinges 87°, 107° and 155° (10 pieces) Height 11 mm	<b>CS-MP3-10</b>	31
	for intermediate hinge with HFL (MD, D, DI) ... (1 item) Height 8 mm	<b>CS-MP0</b>	11,80
	for intermediate hinge with HFL (MD, D, DI) ... (10 items) Height 8 mm	<b>CS-MP0-10</b>	31
	for clip hinges 37° (1 piece)	<b>CS-MP0-37</b>	11,80
	for clip hinges 37° (10 pieces)	<b>CS-MP0-37-10</b>	31
<p><b>Extra charge for wide angle hinge</b> instead of 107° degree hinge on side-hung doors</p>			
	2 units	<b>MP-WW2</b>	13,30
	3 units	<b>MP-WW3</b>	19,40
	4 units	<b>MP-WW4</b>	25,40
	5 units	<b>MP-WW5</b>	32
	6 units	<b>MP-WW6</b>	40
	7 units	<b>MP-WW7</b>	46
	8 units	<b>MP-WW8</b>	52
	9 units	<b>MP-WW9</b>	58
	10 units	<b>MP-WW10</b>	65











# Accessories

		Order no.	Price
	<b>Sealing profile transparent</b> For 16 mm carcass material Available only in 5 m bars	<b>Z 35</b>	9,60
	<b>strengthening rail can be screwed on</b> Finish: aluminium Length: 1918 mm only for swing-doors and through-doors	<b>Z-SPB</b>	54
	<b>Hanging rail for wall units</b>  Suitable for unit width 20 cm Suitable for unit width 25 cm Suitable for unit width 30 cm Suitable for unit width 40 cm Suitable for unit width 45 cm Suitable for unit width 50 cm Suitable for unit width 60 cm Suitable for unit width 80 cm Suitable for unit width 90 cm Suitable for unit width 100 cm Suitable for unit width 120 cm	<b>H-AS 20</b> <b>H-AS 25</b> <b>H-AS 30</b> <b>H-AS 40</b> <b>H-AS 45</b> <b>H-AS 50</b> <b>H-AS 60</b> <b>H-AS 80</b> <b>H-AS 90</b> <b>H-AS 100</b> <b>H-AS 120</b>	10,60 10,60 10,60 11,80 11,80 11,80 11,80 13 13 13 14,30
	<b>Blind plug for 3 mm drill holes</b> Available in all decors from decor group K, packaging unit: 100 pieces	<b>E-ADS03-100</b>	20,80
	<b>Shelf supports</b>  10 shelf supports with pegs 10 shelf supports without pegs 10 shelf supports for adjustable glass shelves 50 shelf supports with pegs 50 shelf supports without pegs 50 shelf supports for adjustable glass shelves	<b>BT31-10</b> <b>BT32-10</b> <b>BTG3-10</b> <b>BT31-50</b> <b>BT32-50</b> <b>BTG3-50</b>	13 13 14,30 23,40 23,40 26
			
			

		Order no.	Price
	<p><b>1 pair (2 items) opening angle limiters 83 degrees for lift-and-fold fittings</b></p>	<p><b>AV-OEW83</b></p>	<p>6,60</p>
	<p> <i>Dimension Y with:</i></p> <p><i>Carcase height 520 mm:</i>  without opening angle limiter: 155 mm  with opening angle limiter 104°: 97 mm  with opening angle limiter 83°: 0 mm  <i>Carcase height 650 mm:</i>  without opening angle limiter: 180 mm  with opening angle limiter 104°: 112 mm  with opening angle limiter 83°: 0 mm  <i>Carcase height 780 mm:</i>  without opening angle limiter: 210 mm  with opening angle limiter 104°: 128 mm  with opening angle limiter 83°: 0 mm</p>		
	<p><b>1 pair (2 items) opening angle limiters 104 degrees for lift-and-fold fittings</b></p>	<p><b>AV-OEW104</b></p>	<p>6,60</p>
	<p> <i>Dimension Y with:</i></p> <p><i>Carcase height 520 mm:</i>  without opening angle limiter: 155 mm  with opening angle limiter 104°: 97 mm  with opening angle limiter 83°: 0 mm  <i>Carcase height 650 mm:</i>  without opening angle limiter: 180 mm  with opening angle limiter 104°: 112 mm  with opening angle limiter 83°: 0 mm  <i>Carcase height 780 mm:</i>  without opening angle limiter: 210 mm  with opening angle limiter 104°: 128 mm  with opening angle limiter 83°: 0 mm</p>		
	<p><b>1 pair (2 items) 75° opening angle limiters for flap door units</b></p>	<p><b>KL-OEW75</b></p>	<p>7,20</p>
	<p>Width 80-120 cm</p>	<p><b>KL-OEW75-1</b></p>	<p>7,20</p>
	<p>Width 30-60 cm</p>		
	<p><b>1 pair (2 items) 100° opening angle limiters for flap door units</b></p>	<p><b>KL-OEW100</b></p>	<p>7,20</p>
	<p>Width 80-120 cm</p>	<p><b>KL-OEW100-1</b></p>	<p>7,20</p>
	<p>Width 30-60 cm</p>		
	<p><b>Plinth foot</b>  Laminate finish, colour black, per item</p>	<p><b>Z 145</b></p>	<p>5,10</p>
	<p><b>Plinth block</b>  Laminate finish, colour black, per item</p>	<p><b>Z 146</b></p>	<p>2,50</p>





# Accessories

	Order no.	Price
 <p><b>Connecting pin</b> For fronts, per item</p>	<b>Z 147</b>	2,50
 <p><b>High-gloss furniture polish set</b> Consisting of: 1 bottle high-gloss polish, 2 cleaning cloths, 1 felt sponge</p>	<b>AM-MPS</b>	63
 <p><b>Soft wax</b> In colours to match the carcass decors, per bar</p>	<b>AM-W</b>	9,90
 <p><b>Touch-up set for lacquer and real wood fronts</b> Touch-up set for lacquer and real wood fronts</p>	<b>Z-ABS</b>	13,70
 <p><b>Ballerina kitchen front cleaning agent for high-gloss lacquer and laminate surfaces</b> quantity 500 ml other applications: glass fronts, stainless steel, laminate, tiles 1L = 36,60 Euro</p>	<b>BAFRHGL500</b>	19,80
 <p><b>Ballerina kitchen total cleaner for micro textured lacquer, velvet lacquer and matt lacquer</b> quantity 500 ml other applications: worktops, natural stone, quartz composites, laminate fronts, extractor hoods, stainless steel surfaces, glass, lacquered wood, sinks, pantries, kitchen appliances, tiles, ovens, hobs, and much more. 1L = 33,60 Euro</p>	<b>BAFRSM500</b>	16,80
 <p><b>Ballerina Premium cloth</b> Premium cloth for streak and smear-free cleaning. Ideal for sensitive surfaces such as high-gloss kitchens, high-gloss furniture, matt kitchen and living room furniture, electrical appliances, taps, etc. extra fine extra absorbent extra gentle</p> <p><i>Instructions for use: Rinse thoroughly prior to first use and after each use. Wash with similar colours. Do not use fabric softener.</i></p>	<b>BAPT40</b>	9,80
 <p><b>Door stops</b></p> <p>10 door stops Standard</p> <p>50 door stops Standard</p> <p>500 door stops Standard</p>	<b>E-TPS10</b>	3,30
	<b>E-TPS50</b>	12,30
	<b>E-TPS500</b>	63

## Accessories

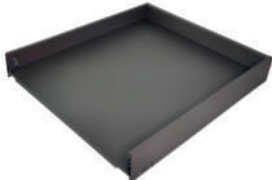
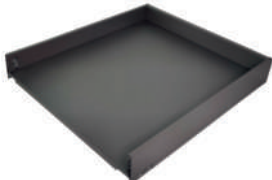
		Order no.	Price
	<b>Door stops</b> For electrical flap doors		
	For electrical flap doors 10 door stops	<b>E-TPEK10</b>	18,80
	For electrical flap doors 50 door stops	<b>E-TPEK50</b>	87
	<b>APL-tightening fitting</b>	<b>E-APLS</b>	3,30
	<b>APL Lamello (5 pieces)</b>	<b>E-APLL</b>	3,30
	<b>Bottom shelf 3 mm thick (metal)</b> with plinth adapter width: 600 mm depth: 555 mm	<b>E-UBMSF6055</b>	87
	<b>1 set = 2 items, clips for hanging in a back cladding</b> With 4 screws 4 x 25	<b>E-RVUCLIP</b>	2,50
	<b>Push-fit shelf substrate for shelves 25 mm thick</b> With 2 wall plugs 8 mm, 2 screws 5.5x60	<b>E-SBT25</b>	3,90
	<b>Push-fit shelf substrate for shelves 50 mm thick and 180 mm deep</b> 2 lag screws, 2 threaded screws, 2 threaded sleeves, 2 washers, 2 grub screws	<b>E-SBT5018</b>	24,90
	<b>Push-fit shelf substrate for shelves 50 mm thick and 365 mm deep</b> 2 lag screws, 2 threaded screws, 2 threaded sleeves, 2 washers, 2 grub screws	<b>E-SBT5036</b>	64
	<b>Tray connector complete for 25 mm panel shelves</b> With screw 6.3 x 13	<b>E-TVB25</b>	3,30

# Accessories

	Order no.	Price
 <p><b>Floor sealing band for panels</b>            Colour black            Length 650 mm, width 10 mm, thickness 3 mm</p> <p> <i>Note: We recommend 2 floor sealing bands for panels from 50 mm thickness. For island panels, please consider the total depth of the panel.</i></p>	<b>BAB-W</b>	7,10
 <p><b>Carcase connecting screws</b>            Quantity 100 pieces</p>	<b>KVS100</b>	16,10
 <p><b>Carcase connecting screws set</b>            consisting of combi-crosshead            and threaded sleeves with pressed head            galvanised            Quantity 1000 pieces</p>	<b>KVSG1000</b>	165
<p><b>Threaded screws for handles</b>            Quantity 50 pieces</p> <p>M4 Length: 20 mm</p> <p>M4 Length: 22 mm</p> <p>M4 Length: 24 mm</p> <p>M4 Length: 25 mm</p> <p>M4 Length: 27 mm</p> <p>M4 Length: 30 mm</p> <p>M4 Length: 33 mm</p> <p>M4 Length: 40 mm</p> <p>M4 Length: 45 mm</p> <p>M4 Length: 48 mm</p> <p>M4 Length: 50 mm</p>	<p><b>GWS 20</b></p> <p><b>GWS 22</b></p> <p><b>GWS 24</b></p> <p><b>GWS 25</b></p> <p><b>GWS 27</b></p> <p><b>GWS 30</b></p> <p><b>GWS 33</b></p> <p><b>GWS 40</b></p> <p><b>GWS 45</b></p> <p><b>GWS 48</b></p> <p><b>GWS 50</b></p>	<p>16,10</p> <p>16,10</p> <p>16,10</p> <p>16,10</p> <p>16,10</p> <p>17,40</p> <p>17,40</p> <p>17,40</p> <p>17,40</p> <p>17,40</p> <p>17,40</p> <p>17,40</p>

## Drawers / Pull-outs

■ = Models also available in 34 cm and 45.5 cm carcase depth (Order no.: ... replace ... 55 ... with 34/45)

 <p><b>Drawer without front for carcase depths 34 cm, 45.5 cm and 55.5 cm</b>            With cushioned self-closing mechanism and full pull-out            Incl. guides</p> <p><i>Ill. shows Legrabox pure Art</i></p>	<p><b>E-SKO300055</b> ■</p> <p><b>E-SKO400055</b> ■</p> <p><b>E-SKO450055</b> ■</p> <p><b>E-SKO500055</b> ■</p> <p><b>E-SKO600055</b> ■</p> <p><b>E-SKO700055</b> ■</p> <p><b>E-SKO800055</b> ■</p> <p><b>E-SKO900055</b> ■</p> <p><b>E-SKO1000055</b> ■</p> <p><b>E-SKO1200055</b> ■</p>	<p>82</p> <p>83</p> <p>84</p> <p>85</p> <p>87</p> <p>100</p> <p>100</p> <p>103</p> <p>107</p> <p>111</p>
 <p><b>drawer without front for carcase depth 70.5 cm</b>            With cushioned self-closing mechanism and full pull-out            Incl. guides</p> <p><i>Ill. shows Legrabox pure Art</i></p>	<p><b>E-SKO300070</b></p> <p><b>E-SKO400070</b></p> <p><b>E-SKO450070</b></p> <p><b>E-SKO500070</b></p> <p><b>E-SKO600070</b></p> <p><b>E-SKO700070</b></p> <p><b>E-SKO800070</b></p> <p><b>E-SKO900070</b></p> <p><b>E-SKO1000070</b></p> <p><b>E-SKO1200070</b></p>	<p>126</p> <p>131</p> <p>133</p> <p>136</p> <p>137</p> <p>148</p> <p>148</p> <p>153</p> <p>156</p> <p>162</p>

# Drawers / Pull-outs

■ = Models also available in 34 cm and 45.5 cm carcass depth (Order no.: ... replace ... 55 ... with 34/45)

Order no.

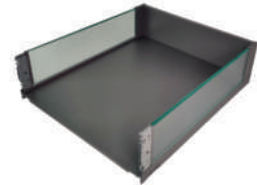
Price



Ill. shows Legrabox pure Art

**Pull-out without front for carcass depths 34 cm, 45.5 cm and 55.5 cm**  
With cushioned self-closing mechanism and full pull-out  
Incl. guides

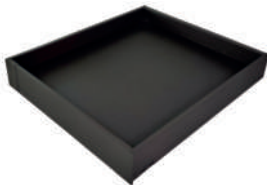
E-AZO300055	■	123
E-AZO400055	■	125
E-AZO450055	■	126
E-AZO500055	■	129
E-AZO600055	■	131
E-AZO700055	■	166
E-AZO800055	■	166
E-AZO900055	■	171
E-AZO1000055	■	173
E-AZO1200055	■	179



Ill. shows Legrabox free

**Pull-out without front for carcass depth 70.5 cm**  
With cushioned self-closing mechanism and full pull-out  
Incl. guides

E-AZO300070		188
E-AZO400070		191
E-AZO450070		192
E-AZO500070		193
E-AZO600070		194
E-AZO700070		210
E-AZO800070		210
E-AZO900070		213
E-AZO1000070		216
E-AZO1200070		224



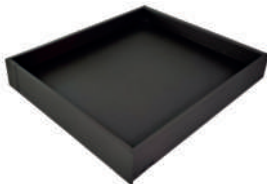
Ill. shows Legrabox pure Art

**internal drawer**  
With cushioned self-closing mechanism and full pull-out  
Incl. guides



**Planning advice:**  
Take account of opening angle

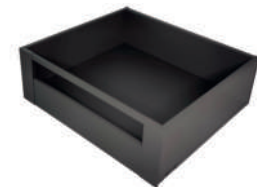
E-ISK300055	■	107
E-ISK400055	■	111
E-ISK450055	■	112
E-ISK500055	■	114
E-ISK600055	■	118
E-ISK700055	■	133
E-ISK800055	■	133
E-ISK900055	■	138
E-ISK1000055	■	144
E-ISK1200055	■	148



Ill. shows Legrabox pure Art

**Internal drawer for 70.5 cm carcass depth**  
With cushioned self-closing mechanism and full pull-out

E-ISK300070		153
E-ISK400070		159
E-ISK450070		161
E-ISK500070		162
E-ISK600070		165
E-ISK700070		182
E-ISK800070		182
E-ISK900070		187
E-ISK1000070		193
E-ISK1200070		199



Ill. shows Legrabox pure Art

**Internal pull-out**  
With cushioned self-closing mechanism and full pull-out  
Incl. guides



**Planning advice:**  
Door with wide angle hinges  
Take account of opening angle

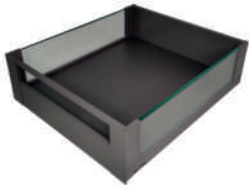
E-IAZ300055	■	154
E-IAZ400055	■	161
E-IAZ450055	■	163
E-IAZ500055	■	166
E-IAZ600055	■	171
E-IAZ700055	■	216
E-IAZ800055	■	216
E-IAZ900055	■	222
E-IAZ1000055	■	229
E-IAZ1200055	■	236

## Drawers / Pull-outs

■ = Models also available in 34 cm and 45.5 cm carcass depth (Order no.: ... replace ... 55 ... with 34/45)

Order no.

Price



Ill. shows Legrabox free

### Internal pull-out for 70.5 cm carcass depth

With cushioned self-closing mechanism and full pull-out



**Planning advice:**

Door with wide angle hinges  
Take account of opening angle

<b>E-IAZ300070</b>	227
<b>E-IAZ400070</b>	234
<b>E-IAZ450070</b>	236
<b>E-IAZ500070</b>	239
<b>E-IAZ600070</b>	245
<b>E-IAZ700070</b>	262
<b>E-IAZ800070</b>	262
<b>E-IAZ900070</b>	267
<b>E-IAZ1000070</b>	271
<b>E-IAZ1200070</b>	287

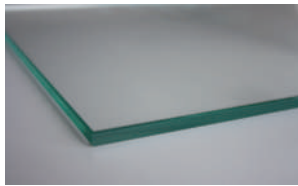
Extra charge for 2 wide angle hinges 155 degrees

<b>SA90155E2</b>	10,50
------------------	-------

Extra charge for 3 wide angle hinges 155 degrees

<b>SA90155E3</b>	17,10
------------------	-------

## Adjustable shelves glass

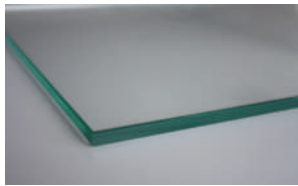


### Adjustable glass shelves incl. shelf support

For wall and base units 34 cm deep

- 45 cm
- 50 cm
- 60 cm
- 80 cm
- 90 cm
- 100 cm

<b>GLB 45</b>	17,70
<b>GLB 50</b>	17,70
<b>GLB 60</b>	20,80
<b>GLB 80</b>	33
<b>GLB 90</b>	33
<b>GLB 100</b>	33



### Adjustable glass shelves incl. shelf support

for HGLD... and HFL(G)

suitable for







Carcass depth 34 cm

- 45 cm
- 50 cm
- 60 cm
- 80 cm
- 90 cm
- 100 cm

<b>GLB 45 08 25</b>	17,70
<b>GLB 50 08 25</b>	17,70
<b>GLB 60 08 25</b>	20,80
<b>GLB 80 08 25</b>	33
<b>GLB 90 08 25</b>	33
<b>GLB 100 08 25</b>	33



# Adjustable shelves

		Order no. W H D	Hinge side: Carcase depth	Decor groups																	
				M10	M20	M30	M40	M50	M60	M70	M80	M90									
	<b>Adjustable shelves incl. shelf supports</b> For wall and base units 34 cm deep																				
	20 cm	Z 21 H 20																			
	25 cm	Z 21 H 25																			
	30 cm	Z 21 H 30																			
	40 cm	Z 21 H 40																			
	45 cm	Z 21 H 45																			
	50 cm	Z 21 H 50																			
	60 cm	Z 21 H 60																			
	80 cm	Z 21 H 80																			
	90 cm	Z 21 H 90																			
	100 cm	Z 21 H 100																			
	120 cm	Z 21 H 120																			
	<b>Adjustable shelves incl. shelf supports</b> For corner wall units																				
	60 x 60 cm	Z 21 HEK60																			
	65 x 65 cm	Z 21 HEK65																			
	80 x 80 cm	Z 21 HEK80																			
	90 x 90 cm	Z 21 HEK90																			
	<b>Adjustable shelves incl. shelf supports</b> For base and tall units 55.5 cm deep																				
	20 cm	Z 21 U 20																			
	25 cm	Z 21 U 25																			
	30 cm	Z 21 U 30																			
	40 cm	Z 21 U 40																			
	45 cm	Z 21 U 45																			
	50 cm	Z 21 U 50																			
	60 cm	Z 21 U 60																			
	80 cm	Z 21 U 80																			
	90 cm	Z 21 U 90																			
	100 cm	Z 21 U 100																			
	120 cm	Z 21 U 120																			
	<b>Adjustable shelves incl. shelf supports</b> For base and tall units 45.5 cm deep																				
	20 cm	Z 21 U 20-45																			
	25 cm	Z 21 U 25-45																			
	30 cm	Z 21 U 30-45																			
	40 cm	Z 21 U 40-45																			
	45 cm	Z 21 U 45-45																			
	50 cm	Z 21 U 50-45																			
	60 cm	Z 21 U 60-45																			
	80 cm	Z 21 U 80-45																			
	90 cm	Z 21 U 90-45																			
	100 cm	Z 21 U 100-45																			
	120 cm	Z 21 U 120-45																			
	<b>Adjustable shelves for carcase depth 60.5 cm</b> suitable for full cupboards and coat stands incl. shelf supports																				
	45 cm	Z21G45-60																			
	50 cm	Z21G50-60																			
	60 cm	Z21G60-60																			
	90 cm	Z21G90-60																			
	100 cm	Z21G100-60																			
	<b>Reinforcement profile for adjustable shelves</b> U- shape Stainless steel look	19 mm																			
	VP 80																				
	VP 90																				
	VP 100																				
	VP 120																				
<b>M 10</b>	<b>M 20</b>	<b>M 30</b>	<b>M 40</b>	<b>M 50</b>																	
K M10 laminate				B M50 Velvet Lacquer S M50 Microstructure Lacquer																	
<b>M 60</b>	<b>M 70</b>	<b>M 80</b>	<b>M 90</b>																		
	F M70 veneer / oak / walnut Z M70 Veneer / Bavaria	H M80 high gloss-Lacquer M M80 Matt-Lacquer																			



## Lighting

<b>LED lights</b>	ZU. XL/GL53-ZU. XL/GL55
<b>Lights - Emotion</b>	ZU. XL/GL55-ZU. XL/GL64
<b>Accessories Lights</b>	ZU. XL/GL65-ZU. XL/GL70
<b>Accessories Lighting easi®</b>	ZU. XL/GL70

### Legend:



**Planning advice**



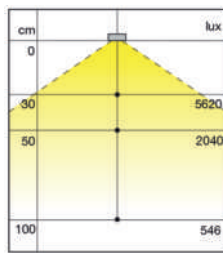
**Merchandise net**



# LED lights

Order no.

Price



## 1 built-in LED spotlight NOVA Eco

24 power LEDs  
2.2W, incl. connection lead 200 cm  
Light colour: warm white 3000 K  
Finish: stainless steel-coloured

**This product contains a light source of energy efficiency class F.**

### Must be planned:

LED converter 30 W incl. 6-way distributor  
or LED converter 60 W incl. 6-way distributor  
Cannot be combined with starter or add-on sets



stainless steel-coloured

**LED-NE**

22,10

black

**LED-NES**

22,10

## LED converters

### Important:

The converters LED-K30 and LED-K60 must not be combined with starter and follow-up sets.



LED converter 30 W incl. 6-way distributor

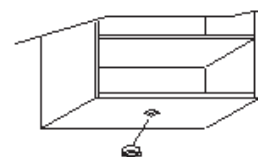
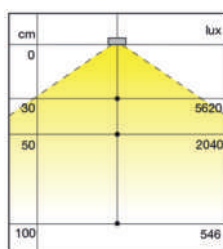
**LED-K 30**

62

LED converter 60 W incl. 6-way distributor

**LED-K 60**

82



## 1 built-in LED spotlight NOVA Eco

with cutout in wall unit bottom shelf  
68 mm hole diameter  
External diameter of decorative ring 75 mm, 24 power LEDs, 2.2 W, incl. connection lead 200 cm  
Light colour: warm white 3000 K  
stainless steel-coloured **This product contains a light source of energy efficiency class F.**

### Important:

Not available for country house wall unit models HGL...

### Must be planned:

LED converter 30 W incl. 6-way distributor  
or LED converter 60 W incl. 6-way distributor  
Cannot be combined with starter or add-on sets



stainless steel-coloured

**AFNEHU-1**

47

black

**AFNESHU-1**

47

as above, but

stainless steel-coloured

**AFNEHU-2**

89

## 2 built-in LED spotlight NOVA Eco

Available from unit width 50 cm  
With cutout in wall unit bottom shelf

**This product contains a light source of energy efficiency class F.**

black

**AFNESHU-2**

89

as above, but

stainless steel-coloured

**AFNEHU-3**

137

## 3 built-in LED spotlight NOVA Eco

Available from unit width 80 cm  
With cutout in wall unit bottom shelf

**This product contains a light source of energy efficiency class F.**

black

**AFNESHU-3**

137

## LED converters

### Important:

The converters LED-K30 and LED-K60 must not be combined with starter and follow-up sets.



LED converter 30 W incl. 6-way distributor

**LED-K 30**

62

LED converter 60 W incl. 6-way distributor

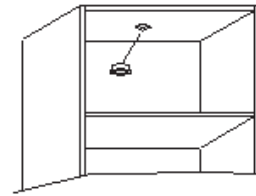
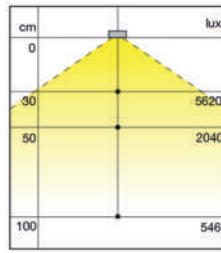
**LED-K 60**

82

# LED lights

Order no.

Price



## 1 built-in LED spotlight NOVA Eco

with cutout in wall unit top shelf,  
68 mm hole diameter  
External diameter of decorative ring 75 mm,  
24 power LEDs, 2.2 W,  
incl. connection lead 200 cm,  
Light colour: warm white 3000 K  
stainless steel-coloured

stainless steel-coloured

**AFNEHO-1**

47

black

**AFNESH0-1**

47

### Must be planned:

LED converter 30 W incl. 6-way distributor or LED converter 60 W incl. 6-way distributor **This product contains a light source of energy efficiency class F.**

### Important:

Not available for country house wall unit models HGL...  
Cannot be combined with starter or add-on sets



### as above, but

## 2 built-in LED spotlight NOVA Eco

Available from unit width 50 cm  
with cutout in wall unit top shelf,  
**This product contains a light source of energy efficiency class F.**

stainless steel-coloured

**AFNEHO-2**

89

black

**AFNESH0-2**

89

### as above, but

## 3 built-in LED spotlight NOVA Eco

Available from unit width 80 cm  
with cutout in wall unit top shelf,  
**This product contains a light source of energy efficiency class F.**

stainless steel-coloured

**AFNEHO-3**

137

black

**AFNESH0-3**

137



## Interior lighting for unit BASKI SF, clip-on

with infrared sensor BASKI SF IR  
Including holder, super-slim cabinet interior LED light  
The light switches on when the unit door is opened.  
180 LED/m  
Power supply: 12 V DC  
Incl. 2 m power supply lead  
Colour: black  
Installation: clip-on light

For carcase width 45 cm (3.6 W) Price per item

**LED-SIBIR45**

80

For carcase width 50 cm (4.1 W) Price per item

**LED-SIBIR50**

82

For carcase width 60 cm (5.0 W) Price per item

**LED-SIBIR60**

83

For carcase width 80 cm (7.0 W) Price per item

**LED-SIBIR80**

90

For carcase width 90 cm (7.9 W) Price per item

**LED-SIBIR90**

93

For carcase width 100 cm (6.6 W) Price per item

**LED-SIBIR100**

94

For carcase width 120 cm (10.8 W) Price per item

**LED-SIBIR120**

102

### Must be planned:

LED converter 30 W incl. 6-way distributor or LED converter 60 W incl. 6-way distributor  
Cannot be used for items with a drawer



## LED converters

### Important:

The converters LED-K30 and LED-K60 must not be combined with starter and follow-up sets.



LED converter 30 W incl. 6-way distributor

**LED-K 30**



62

LED converter 60 W incl. 6-way distributor

**LED-K 60**

82

# LED lights

		Order no.	Price
	<b>Connection cable for LED lights (not for RGB)</b> 180 cm, with 6-way distributor	<b>LED-VER180</b>	8,60
	<b>ON/OFF switch</b> Stainless steel-coloured melamine With 2 m power supply lead and Euro plug and 2 m power supply lead and Euro coupling	<b>Z 100</b>	63

## Lights - Emotion


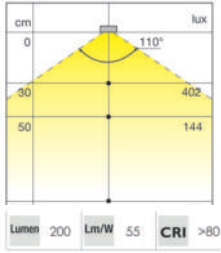
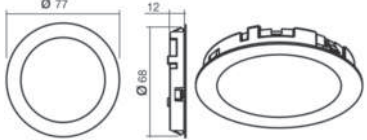



**Must be planned:**  
 Starter set LED4-ASET60/LED-ASET60/LED-ASET60FB

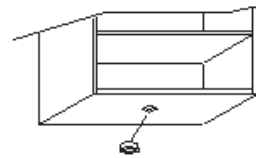
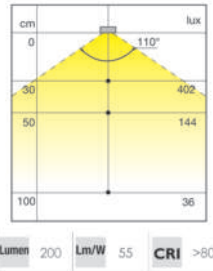


Order no.

Price

 			
<p><b>1 built-in LED spotlights Moonlight "Emotion"</b>                      LED Moonlight 68 Emotion, 3.6 W                      Homogeneous light, without visible light spots                      Installation depth of 12 mm                      Colours: stainless steel                      Installation diameter: Ø 68                      12 V DC incl. connection lead 200 cm                      Light Emotion: infinitely variable colour temperature, from warm white (2700 K) to cold white (6500 K), including dimming function <b>This product contains a light source of energy efficiency class F.</b></p>	<p>stainless steel-coloured</p> <p>black</p>	<p><b>LED-ML</b></p> <p><b>LED-MLS</b></p>	<p>51</p> <p>51</p>
<p><b>Must be planned:</b>                      Starter set and, if necessary, add-on set</p> 			





**1 built-in LED spotlights Moonlight "Emotion" With cutout in wall unit bottom shelf**

LED Moonlight 68 Emotion, 3.6 W  
 Homogeneous light, without visible light spots  
 Installation depth of 12 mm  
 Colours: stainless steel  
 Installation diameter: Ø 68  
 12 V DC incl. connection lead 200 cm  
 Light Emotion: infinitely variable colour temperature, from warm white (2700 K) to cold white (6500 K), including dimming function **This product contains a light source of energy efficiency class F.**

stainless steel-coloured

**AFMLHU-1**

93

black

**AFMLSHU-1**

93

**Important:**  
 Not available for country house wall unit models HGL...  
**Must be planned:**  
 Starter set and, if necessary, add-on set



**as above, but 2 built-in LED spotlights Moonlight "Emotion" With cutout in wall unit bottom shelf**

Available from unit width 50 cm **This product contains a light source of energy efficiency class F.**

stainless steel-coloured

**AFMLHU-2**

187

black

**AFMLSHU-2**

187

**as above, but 3 built-in LED spotlights Moonlight "Emotion" With cutout in wall unit bottom shelf**

Available from unit width 80 cm **This product contains a light source of energy efficiency class F.**

stainless steel-coloured

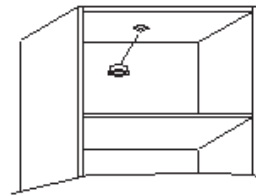
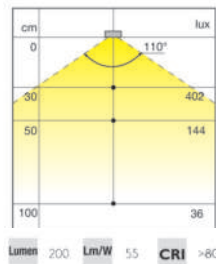
**AFMLHU-3**

279

black

**AFMLSHU-3**

279



**1 built-in LED spotlights Moonlight "Emotion" with cutout in wall unit top shelf,**

LED Moonlight 68 Emotion, 3.6 W  
 Homogeneous light, without visible light spots  
 Installation depth of 12 mm  
 Colours: stainless steel  
 Installation diameter: Ø 68  
 12 V DC incl. connection lead 200 cm  
 Light Emotion: infinitely variable colour temperature, from warm white (2700 K) to cold white (6500 K), including dimming function  
**This product contains a light source of energy efficiency class F.**

stainless steel-coloured

**AFMLHO-1**

93

black

**AFMLSHO-1**

93

**Important:**  
 Not available for country house wall unit models HGL...  
**Must be planned:**  
 Starter set and, if necessary, add-on set



**as above, but 2 built-in LED spotlights Moonlight "Emotion" with cutout in wall unit top shelf,**

Available from unit width 50 cm **This product contains a light source of energy efficiency class F.**

stainless steel-coloured

**AFMLHO-2**

187

black

**AFMLSHO-2**

187

**as above, but 3 built-in LED spotlights Moonlight "Emotion" with cutout in wall unit top shelf,**

Available from unit width 80 cm **This product contains a light source of energy efficiency class F.**

stainless steel-coloured

**AFMLHO-3**

279

black

**AFMLSHO-3**

279





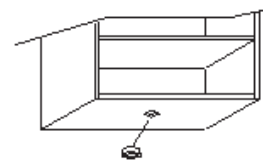
**1 built-in LED spotlights HOLL TH**

Spotlight with light edge, 3.8 W  
 Homogeneous light, without visible light spots  
 Installation depth of 12 mm  
 Colour: black Installation diameter: Ø 68  
 12 V DC incl. connection lead 200 cm  
 continuously variable colour temperature, from warm white (2700 K) to cold white (6000 K), including dimming function  
**This product contains a light source of energy efficiency class F.**

LED-HOL S

59

**Must be planned:**  
 Starter set and, if necessary, add-on set



**1 built-in LED spotlights HOLL TH  
 With cutout in wall unit bottom shelf**

Spotlight with light edge, 3.8 W  
 Homogeneous light, without visible light spots  
 Installation depth of 12 mm  
 Colour: black  
 Installation diameter: Ø 68  
 12 V DC incl. connection lead 200 cm  
 continuously variable colour temperature, from warm white (2700 K) to cold white (6000 K), including dimming function  
**This product contains a light source of energy efficiency class F.**

AF HSHU-1

70

**Must be planned:**  
 Starter set and, if necessary, add-on set



**as above, but 2 built-in LED spotlights HOLL TH With cutout in wall unit bottom shelf**

**This product contains a light source of energy efficiency class F.**  
 Available from unit width 50 cm

AF HSHU-2

138

**Must be planned:**  
 Starter set and, if necessary, add-on set



**as above, but  
 3 built-in LED spotlights HOLL TH  
 With cutout in wall unit bottom shelf**

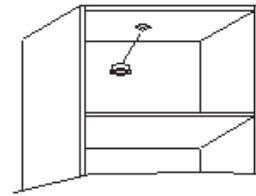
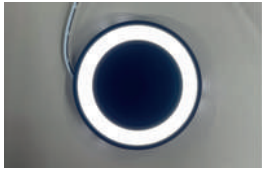
**This product contains a light source of energy efficiency class F.**  
 Available from unit width 80 cm

AF HSHU-3

208

**Must be planned:**  
 Starter set and, if necessary, add-on set





**1 built-in LED spotlights HOLL TH with cutout in wall unit top shelf,**

Spotlight with light edge, 3.8 W  
Homogeneous light, without visible light spots  
Installation depth of 12 mm  
Colour: black

Installation diameter: Ø 68  
12 V DC incl. connection lead 200 cm  
continuously variable colour temperature, from warm white (2700 K) to cold white (6000 K), including dimming function  
**This product contains a light source of energy efficiency class F.**

**Must be planned:**  
Starter set and, if necessary, add-on set



**AF HSHO-1**

70

**as above, but 2 built-in LED spotlights HOLL TH with cutout in wall unit top shelf,**

**This product contains a light source of energy efficiency class F.**  
Available from unit width 50 cm

**Must be planned:**  
Starter set and, if necessary, add-on set



**AF HSHO-2**

138

**as above, but 3 built-in LED spotlights HOLL TH with cutout in wall unit top shelf,**

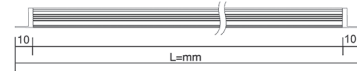
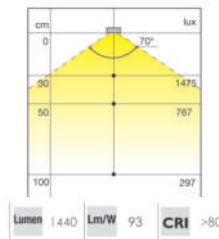
**This product contains a light source of energy efficiency class F.**  
Available from unit width 80 cm

**Must be planned:**  
Starter set and, if necessary, add-on set



**AF HSHO-3**

208



**LED light Manila IV „Emotion“**

downlighting for wall units and Cabinet interior lighting for wall units  
Homogeneous light, without visible light spots  
High-quality aluminium profile  
Colour: stainless steel  
12 V DC

Light Emotion: infinitely variable colour temperature, from warm white (2700 K) to cold white (6500 K), including dimming function  
For wall units of 30 cm to 120 cm width (standard carcass widths only, no corner wall units)  
**This product contains a light source of energy efficiency class F.**

**Important:**  
Not available for country house wall unit models HGL...



For carcass width 30 cm (3.49 W)	<b>LED-M4 30</b>	50
For carcass width 40 cm (5.04 W)	<b>LED-M4 40</b>	59
For carcass width 45 cm (5.81 W)	<b>LED-M4 45</b>	62
For carcass width 50 cm (6.59 W)	<b>LED-M4 50</b>	67
For carcass width 60 cm (8.14 W)	<b>LED-M4 60</b>	75
For carcass width 70 cm (9.7 W)	<b>LED-M4 70</b>	80
For carcass width 80 cm (11.24 W)	<b>LED-M4 80</b>	94
For carcass width 90 cm (12.79 W)	<b>LED-M4 90</b>	104
For carcass width 100 cm (14.34 W)	<b>LED-M4 100</b>	112
For carcass width 120 cm (17.44 W)	<b>LED-M4 120</b>	136

**Preparation of bottom shelves**  
(light exposure for example on the worktop)  
For built-in LED light Manila IV, cutout 120 mm from rear edge, for concealed wiring

**MP-VHUBLEDM**

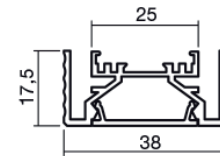
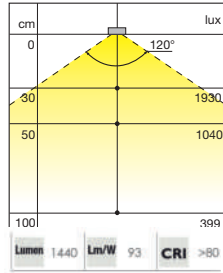
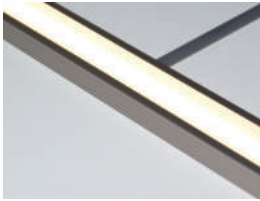
43



**Preparation of the top shelves**  
(light exposure in the carcass)  
For built-in LED light Manila IV,  
cutout 120 mm from rear edge,  
for concealed wiring

**MP-VHOBLEDM**

43



**LED base light Manila Plus**

For on-site installation below corner wall units  
For on-site installation below straight surfaces  
Incl. connecting cable and cable channel (10 x 4.5 x 280 mm),  
With hole cover for cable duct 10 x 4.5 mm, cable exit central  
Homogeneous light  
High-quality aluminium profile, stainless steel-coloured anodised 12 V DC  
Emotion: infinitely variable colour temperature, from warm white (2700 K) to cold white (6500 K), including dimming function+ **This product contains a light source of energy efficiency class F.**

Length 45 cm (7.0 W), suitable for corner wall units with side dimensions 60 x 60 cm, 65 x 65 cm

**LED-MP 45**

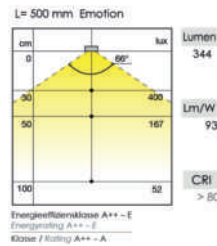
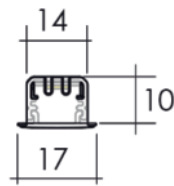
77

Length 65 cm (10.0 W), suitable for corner wall units with side dimensions 80 x 80 cm, 90 x 90 cm

**LED-MP 65**

86

**Must be planned:**  
Starter set and, if necessary, add-on set



**Malindi „Emotion“ LED light set for carcass interior sides in unit types with swing doors**

Homogeneous light, without visible light spots  
High-quality aluminium profile  
Colour: stainless steel  
12 V DC

**This product contains a light source of energy efficiency class F.**

Carcass height 39 cm (3 W)

**LED-MAL 39**

27.20

Carcass height 52 cm (3.7 W)

**LED-MAL 52**

32

Carcass height 65 cm (5.2 W)

**LED-MAL 65**

43

Carcass height 78 cm (6.3 W)

**LED-MAL 78**

48

Carcass height 84,5 cm (6.8 W)

**LED-MAL 85**

53

Carcass height 91 cm (7.3 W)

**LED-MAL 91**

53

Carcass height 143 cm (10.8 W)

**LED-MAL143**

61

Carcass height 156 cm (11.8 W)

**LED-MAL156**

67

Carcass height 168,8 cm (12.8 W)

**LED-MAL169**

74

Carcass height 181,8 cm (13.8 W)

**LED-MAL182**

77

Carcass height 194,8 cm (14.9 W)

**LED-MAL195**

85

Carcass height 207,8 cm (15.9 W)

**LED-MAL208**

90

Carcass height 220,8 cm (16.9 W)

**LED-MAL221**

91

Emotion: infinitely variable colour temperature, from warm white (3000 K) to cold white (6000 K), including dimming function

**Must be planned:**  
Starter set and, if necessary, add-on set



Must be planned:

**Preparation of the left or right-hand carcass side for Malindi LED light set** The Malindi LED light is available for:

- unit types with side-hung doors with glass finish
- unit types with side-hung doors with wood finish in the heights 52, 65, 78, 84.5, and 91 cm with adjustable shelves behind
- unit types from the Dressing Room range (items DR... and URIF...)

Malindi LED light is not available for:

- corner units in all areas
- unit types with fixed shelf
- unit types with side-hung doors with installations behind (internal drawers, internal pull-outs, larder pull-outs, etc.)
- modular system

**Preparation of the carcass side for Malindi LED light set**

For built-in Manila LED light, for concealed wiring  
Carcass interior side milled

prepared for the left-hand side

**MP-MALVKF-L**

43

prepared for the right-hand side

**MP-MALVKF-R**

43

prepared for both sides

**MP-MALVKF-B**

86





**Interior lighting for shelves  
BASKI SF, clip-on**

Including holder, super-slim cabinet interior LED light  
180 LED/m  
continuously variable colour temperature, from warm white (2700 K) to cold white (6000 K), including dimming function  
Power supply: 12 V DC  
Incl. 2 m power supply lead  
Colour: black  
Installation: clip-on light

For carcass width 30 cm (1.6 W) Price per item

**LED-SIB 30**

39

For carcass width 40 cm (2.4 W) Price per item

**LED-SIB 40**

44

For carcass width 45 cm (2.6 W) Price per item

**LED-SIB 45**

46

For carcass width 50 cm (3.0 W) Price per item

**LED-SIB 50**

48

For carcass width 60 cm (3.8 W) Price per item

**LED-SIB 60**

53

For carcass width 80 cm (5.2 W) Price per item

**LED-SIB 80**

64

For carcass width 90 cm (5.8 W) Price per item

**LED-SIB 90**

67

For carcass width 100 cm (6.6 W) Price per item

**LED-SIB 100**

74

**Must be planned:**  
Starter set and, if necessary, add-on set



Wandboard (L = 900 mm)	2700-6500 K
0 cm	
30 cm	470-520 lx
50 cm	198-212 lx
75 cm	99-109 lx
100 cm	63-69 lx



**LED wall shelf „Emotion“**

**Lighting to top and bottom for wall mounting  
Dimmable with continuously adjustable colour temperature using Emotion technology**

Including fitted 30W converter 12V DC and Emotion remote receiver and remote control  
Operating voltage: 12V DC  
Power consumption: 5 W  
Output per metre: 24W/m  
Light colour: Emotion (2700 – 6500 Kelvin)

Width 90 cm, 21.0 W, price per item

**LED-EMO 90**

430

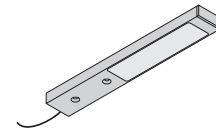
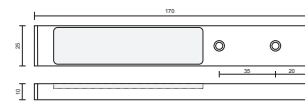
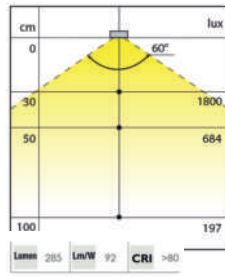
Width 120 cm, 28.2 W, price per item

**LED-EMO120**

493

Starting colour: warm white  
Colour reproduction: >90  
Luminous flux/m: 352-386 lm  
Number of LED/m: 120+120 pieces  
Radiation angle 80 degrees  
High-quality design  
Material: aluminium  
Surface: matt black  
Load capacity: maximum 1kg/100mm  
Supply cable: 2m white with Euro plug





**Lighting set RETTANGOLO LFL "Emotion"**

3 LED designer lights Rettangolo LFL  
 per light 3.1 W  
 Connection lead 200 cm and plug system  
 Homogeneous light, without visible light spots  
 Emotion: infinitely variable colour temperature, from warm white (2700 K) to cold white (6500 K), including dimming function  
**This product contains a light source of energy efficiency class F.**

stainless steel-coloured

**LED-RET 3**

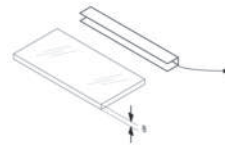
139

black

**LED-RET 3S**

139

**Note: Must be planned:**  
 Starter set and, if necessary, add-on set



**Glass edge lighting „Emotion“**

Aluminium profile with LED equipment  
 1 LED per 5 cm  
 Incl. 2 m power supply lead  
 Light Emotion: infinitely variable colour temperature, from warm white (2700 K) to cold white (6500 K), including dimming function  
**This product contains a light source of energy efficiency class F.**

Suitable for glass shelf 45 cm (2.73 W)

**LED-GKB 45**

32

Suitable for glass shelf 50 cm (3.12 W)

**LED-GKB 50**

37

Suitable for glass shelf 60 cm (3.90 W)

**LED-GKB 60**

44

Suitable for glass shelf 90 cm (6.24 W)

**LED-GKB 90**

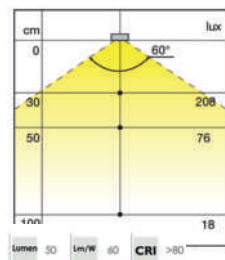
62

Suitable for glass shelf 100 cm (7.02 W)

**LED-GKB100**

69

**Note**  
 Cannot be used for units with centre panel!  
**Must be planned:**  
 Starter set and, if necessary, add-on set



**Glass edge lighting Glaspoint „Emotion“**

Small design, radiates upward and downwards  
 LEDs are protected by transparent covers on both sides  
 Including dimming function  
 Add-on light fixture with LEDs on the top and bottom sides  
 Easy installation with fixing clips  
 Colour: black  
 Connection lead: 200 cm, 12 V DC, 0.9 W  
 Emotion: infinitely variable colour temperature, from warm white (2700 K) to cold white (6500 K), including dimming function **This product contains a light source of energy efficiency class F.**

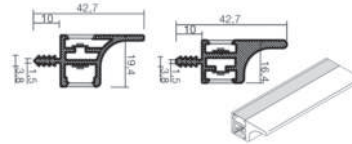
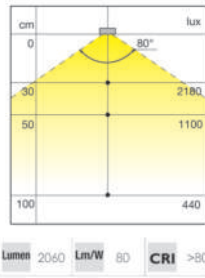
**LED-POINT**

29

**Must be planned:**  
 Starter set and, if necessary, add-on set







**LED light UP&DOWN**

Fitted LED light behind grip ledge, 24.6 W/m  
 LED strip at top: 60 + 60 LEDs/m  
 LED strip at bottom: 120 + 120 LEDs/m  
 Top and bottom light at the same time for wall units from 45 cm up to 120 cm width (only standard carcass widths) only available pre-installed in wall unit  
 Emotion: infinitely variable colour temperature, from warm white (2700 K) to cold white (6500 K), including dimming function  
**This product contains a light source of energy efficiency class F.**

**Important:**  
 Not available for country house wall unit models HGL...

**Must be planned:**  
 Starter set and, if necessary, add-on set



For carcass width 45 cm (9.84 W)	<b>BLEDU 45</b>	162
For carcass width 50 cm (11.07 W)	<b>BLEDU 50</b>	173
For carcass width 60 cm (13.53 W)	<b>BLEDU 60</b>	206
For carcass width 70 cm (16.5 W)	<b>BLEDU 70</b>	226
For carcass width 80 cm (18.45 W)	<b>BLEDU 80</b>	253
For carcass width 90 cm (20.91 W)	<b>BLEDU 90</b>	282
For carcass width 100 cm (23.37 W)	<b>BLEDU 100</b>	292
For carcass width 120 cm (28.29 W)	<b>BLEDU 120</b>	353

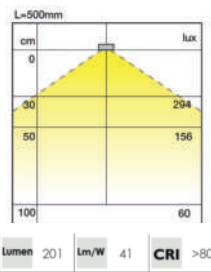
**LED light UP&DOWN**

**Replacement set, only LED lights without grip ledge**  
 Fitted LED light behind grip ledge, 24.6 W/m  
 LED strip at top: 60 + 60 LEDs/m  
 LED strip at bottom: 120 + 120 LEDs/m  
 Top and bottom light at the same time for wall units from 45 cm up to 120 cm width (only standard carcass widths) only available pre-installed in wall unit  
 Emotion: infinitely variable colour temperature, from warm white (2700 K) to cold white (6500 K), including dimming function  
**This product contains a light source of energy efficiency class F.**

**Must be planned:**  
 Starter set and, if necessary, add-on set



For carcass width 45 cm (9.84 W)	<b>AS-BLEDU45</b>	53
For carcass width 50 cm (11.07 W)	<b>AS-BLEDU50</b>	66
For carcass width 60 cm (13.53 W)	<b>AS-BLEDU60</b>	75
For carcass width 80 cm (18.45 W)	<b>AS-BLEDU80</b>	94
For carcass width 90 cm (20.91 W)	<b>AS-BLEDU90</b>	106
For carcass width 100 cm (23.37 W)	<b>AS-BLEDU100</b>	115
For carcass width 120 cm (28.29 W)	<b>AS-BLEDU120</b>	139



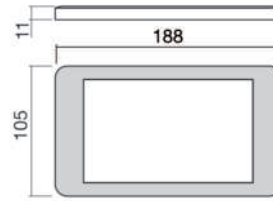
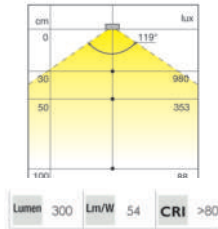
**LED strip 200 cm, siliconised**

self-adhesive LED strip module, siliconised, 6.8 W  
 Adhesive strip on the back enables easy installation  
 Can be individually cut to size (mark under adhesive film)  
 3 LED strips can be combined with one another  
 Lengths: 200 cm, 30 LED per 100 cm, incl. 1 m cable  
 Light Emotion: infinitely variable colour temperature, from warm white (2700 K) to cold white (6500 K), including dimming function **This product contains a light source of energy efficiency class F.**

<b>LED-ST200</b>	72
------------------	----





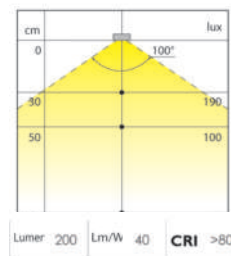


Emotion

**iiLED „Emotion“ top-mounted light 5.5 W**  
 Top-mounted light for use under wall units, fitted shelves and open shelves  
 Homogeneous light on illuminated area, without visible light spots  
 Fitted height 11 mm  
 Colour: stainless steel  
 12 V DC  
 5.50 W  
 Incl. 2 m power supply lead  
 Light Emotion: infinitely variable colour temperature, from warm white (2700 K) to cold white (6500 K), including dimming function **This product contains a light source of energy efficiency class F.**

LED-IILED

112



Emotion

**LED lighting Nubia “Emotion“ variable in length**  
 fitted with LED 12 V DC, 2 x 60 LEDs/m, 7.8 W/m  
 Incl. cable 200 cm for each light (self-adhesive) max. length: 400 cm,  
 No connection between individual lights, i.e. each light is connected to the converter.  
 Light Emotion: infinitely variable colour temperature, from warm white (2700 K) to cold white (6500 K), including dimming function **This product contains a light source of energy efficiency class F.**

per 10 cm Width

LED-STV

10,70

**Calculation of the length of lights depends on the carcass width:**

Length reduction for end caps per side 0.5 cm  
 Length reduction for outside corners per side 2.5 cm  
 Inside corners are neutral in length

LED-STVEK

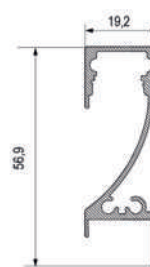
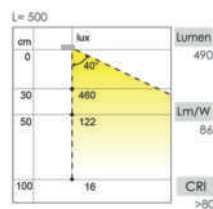
4,30

LED-STVAE

4,30

LED-STVIE

4,30



Emotion

**„Emotion“ VENICE A LED surface-mounted lighting**  
 For recess back panels  
 High-quality aluminium profile, stainless steel look for mounting on a recess back panel of 1.6 mm thickness  
 Light emotion: infinitely variable colour temperature from warm white (2700 K) to cold white (6500 K), incl.  
 Homogeneous light, without visible light spots  
 Dimming function  
 Fitted with LED Emotion 12 V DC  
 2 x 120 LEDs/m  
 12 W/m  
 Incl. 200 cm cable  
 Max. profile length 300 cm  
 End caps left and right are included in scope of delivery.  
 Cable outlet left  
**This product contains a light source of energy efficiency class F.**

per 10 cm Width

NRW-LEDV

19,40

**Not available for:** Glass recess back panels  
**Planning advice:** At a recess height of 48 cm, the height of the recess back panel is reduced by 4.5 cm.



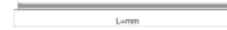
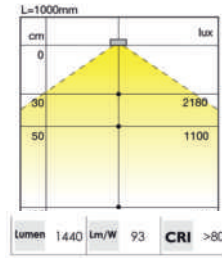
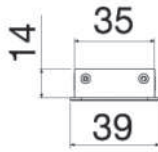
**Must be planned:**  
 Starter set LED4-ASET60/LED-ASET60/LED-ASET60FB



**Connection piece for 90-degree corners for VENICE A „Emotion“ LED surface-mounted lighting**

**NRW-LEDV-VS90**

10,70



**Built-in LED light Venice "Emotion"**

for indirect lighting in recess back panels (no glass recess back panels)

High-quality aluminium profile, stainless steel look

Light Emotion: infinitely variable colour temperature, from warm white (2700 K) to cold white (6500 K), including dimming function

**This product contains a light source of energy efficiency class F.** Cable outlet right

**Note:** At least 100 mm distance from top and bottom edge.  
At least 50 mm distance from side edges.  
Not available for glass recess back panels.  
We recommend a minimum height of 480 mm for the recess back panel.



**An accurate dimensioned drawing is required for production!**

500 mm, 6.98 W, for recess back panels over 600 mm wide

**NRW-LED50**

112

800 mm, 11.63 W, for recess back panels over 900 mm wide

**NRW-LED80**

142

1100 mm, 16.28 W, for recess back panels over 1200 mm wide

**NRW-LED110**

174

1400 mm, 20.93 W, for recess back panels over 1500 mm wide

**NRW-LED140**

202

1700 mm, 25.58 W, for recess back panels over 1800 mm wide

**NRW-LED170**

237

2000 mm, 30.23 W, for recess back panels over 2100 mm wide

**NRW-LED200**

264

2300 mm, 34.88 W, for recess back panels over 2400 mm wide

**NRW-LED230**

299

**Preparation of the recess back panels**

For built-in LED light Venice "Emotion"

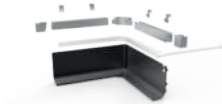
**An accurate dimensioned drawing is required for production!**

**Note:** At least 100 mm distance from top and bottom edge.  
At least 50 mm distance from side edges.  
Not available for glass recess back panels.  
We recommend a minimum height of 480 mm for the recess back panel.



**MP-VNRWLED**

117



**Grip ledge LED light for L profile**

Installation only in L profile

fitted with LED 12 V DC, 2 x 60 LEDs/m, 6.5 W/m

Incl. power supply lead 200 cm per light

max. length 450 cm, cut to size by the manufacturer. No connection between individual lights, i.e. each light is connected to the converter.

End caps, inside and outside corner included in scope of delivery.

incl. aluminium profile

Aluminium, stainless steel-coloured

Emotion: infinitely variable colour temperature, from warm white (2700 K) to cold white (6500 K), including dimming function


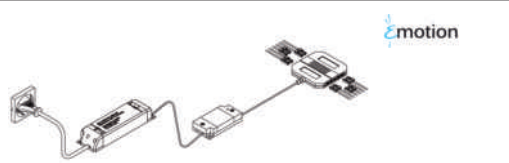

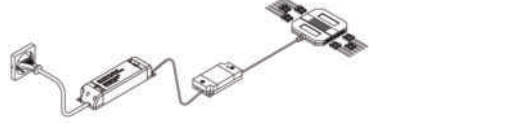



**This product contains a light source of energy efficiency class F.**

**LED-LKL**

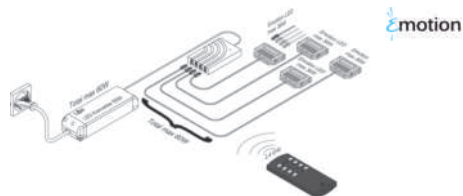
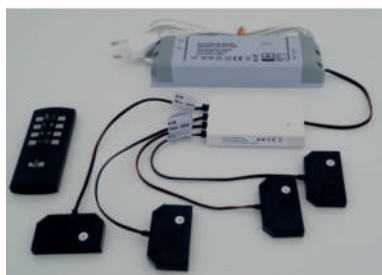
10,20



# Accessories Lights

		Order no.	Price
	<p><b>Starter set Emotion 1-channel control 60 W</b>            consisting of:            1 converter 12 V DC, 60 W            LED signal amplifier to boost the switching power  <b>1 wall switch infinitely variable (double rocker)</b>            Colour temperatures from warm white to cold white, dimming function.            12-way distributor</p> <p><i>Memory function: The last setting is saved. AutoON: Setting is retained following a power outage.</i></p>	 <p><b>LED-ASET60</b></p> <p>as above, but            Emotion 1-channel control 60 W            with remote control            instead of wall switch</p> <p><b>LED-ASET60FB</b></p>	<p>221</p> <p>160</p>
	<p><b>Follow up set            Emotion 1-channel control 60 W</b>            consisting of            1 converter 12 V DC, 60 W            LED signal amplifier to boost the switching power            12-way distributor</p> <p><i>Memory function: The last setting is saved. AutoON: Setting is retained following a power outage.            The matching starter set is always required for the following set</i></p>	 <p><b>LED-FSET60</b></p>	<p>120</p>
	<p><b>Remote control - optional -</b>            For Emotion starter set 1-channel control            Incl. magnetic wall mount            Colour: black</p>	<p><b>LED-FB1</b></p>	<p>44</p>
	<p><b>Emotion dimmer switch, double rocker</b>  <b>Only compatible with single-channel controller</b>            Function: double rocker            Infinitely variable setting of light temperature            Dimming function            Battery powered (1 x CR2430)            Cordless mounting            Dimensions: 86 x 86 x 14 mm (W x H x D)</p> <p><i>Compatible with several standard frames (e.g. Gira, Berker, Jung, Merten)</i></p>	<p><b>LED-DS</b></p>	<p>91</p>
	<p><b>Connection cable            for LED lights (not for RGB)</b>            180 cm, with 6-way distributor</p>	<p><b>LED-VER180</b></p>	<p>8.60</p>

Order no.



**Starter set**

**4-channel "Emotion" control, start-up set 12 V, 60 W**

Emotion control for up to 4 Emotion light groups with remote control incl. magnetic wall mount,

with 4 piece 6-way distributor, starter set up to 60 W

Infinitely variable colour temperature from warm white to cold white

Functions per channel: light on/off and dimming per light group

Functions for all channels: light on/off, dimming, colour temperature adjustment from warm white to cold white

Memory function: The last setting is saved.

Overall power 60 W

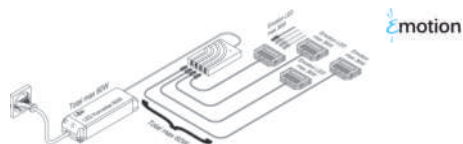
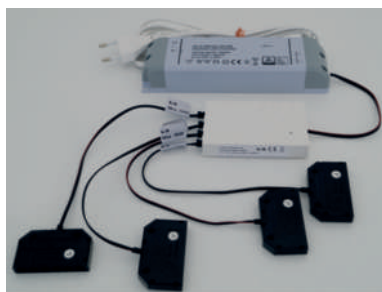
Maximum 36 W per channel

Can be cordlessly extended with 4-channel Emotion follow-up set

Cable: 4 x 0.2 m LED 6-way distributor

**LED4-ASET60**

243



**Follow up set**

**4-channel "Emotion" control, start-up set 12 V, 60 W**

Emotion control for up to 4 Emotion light groups

With 4 piece 6-way distributor

Follow up set with remote control.

Infinitely variable colour temperature from warm white to cold white

Functions per channel: light on/off and dimming per light group

Functions for all channels: light on/off, dimming, colour temperature adjustment from warm white to cold white

Memory function: The last setting is saved.

Overall power 60 W

Maximum 36 W per channel

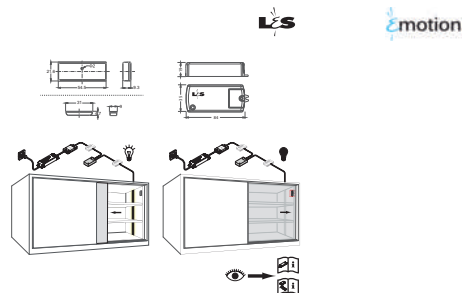
Cable: 4 x 0.2 m LED 6-way distributor

**LED4-FSET60**

187

**Note:**

The matching starter set is always required for the following set



**Set of wireless magnetic door contact switches with Emotion controller**

consisting of:

1 receiver with 200 cm cable and 6-way distributor maximum (36 W)

1 wireless transmitter with magnet for mounting on the carcass side (sticking)

Max. reach 20 m

For transmitting Emotion signals

Compatible with all LED lighting

**LED-MTS**

46

**For connecting to:**

Converter LED-K30 or LED-K 60

1-channel-system LED-ASET 60 or LED-FSET 60

4-channel-system LED4-ASET 60 or LED4-FSET 60



# Accessories Lights

Order no.

Price



Emotion



### Starter set built in energy box (IP44 box)

Emotion 1-channel control 60 W

consisting of

1 converter 12 V DC, 60 W 16 mm thick

LED signal amplifier to boost the switching power

1 remote control

1 black aluminum energy box

(including milling for the cable passage)



Colour temperatures from warm white to cold white, dimming function.

6-way distributor

Memory function: The last setting is saved.

AutoON: Setting is retained following a power outage.

LED-ASETEBOX60

202



### Follow up set

built in energy box (IP44 box)

Emotion 1-channel control 60 W

consisting of

1 converter 12 V DC, 60 W 16 mm thick

LED signal amplifier to boost the switching power

1 black aluminum energy box (including milling for the cable passage)



Colour temperatures from warm white to cold white, dimming function.

12-way distributor

Memory function: The last setting is saved.

AutoON: Setting is retained following a power outage.

The matching starter set is always required for the following set

LED-FSETEBOX60

160



**Starter set Emotion Driver, 12 V, 60 W**

Emotion Driver with 6 integrated jacks  
incl. connection lead 2 m with flat Euro plug  
remote control, 1 x 6-way distributor  
Overall power 60 W  
Can be wirelessly extended to include Emotion follow up set



*Infinitely variable colour temperature from warm white to cold white  
Functions per channel: light on/off and dimming per light group  
Memory function: The last setting is saved.  
with integrated wireless receiver module 3.1*

**Additional note:**

**This starter set can also be used**  
in combination with the  
L&S app - to be found in the Appstore\*\* or Google Play Store under L&S Remote.  
In this case, a connection between the app and the module 3 within the converter  
is established via Bluetooth.  
Therefore, neither the Emotion Driver Homebase or the Philips Hue Bridge is  
necessary.

**LED-ASET4HOME60**

221



**Follow up set  
Emotion Driver, 12 V, 60 W**

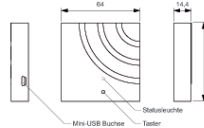
Emotion Driver with 6 integrated jacks  
incl. connection lead 2 m with flat Euro plug  
1 x 6-way-distributor  
Overall power 60 W



*Infinitely variable colour temperature from warm white to cold white  
Functions per channel: light on/off and dimming per light group  
Memory function: The last setting is saved.  
with integrated wireless receiver module 3.1  
The matching starter set is always required for the following set*

**LED-FSET4HOME60**

168



**Emotion Driver Homebase,  
5 V DC, Zigbee 3.0**

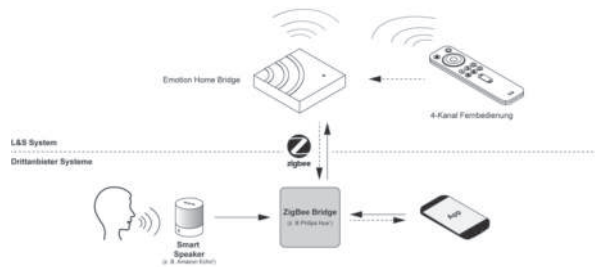
Zigbee Client for communicating between L&S lighting control systems and  
the Home Base Smart Home environment  
for connecting Smart Home system and Sound Speaker controllers  
- Control via voice input, app or remote control  
- Voice control in conjunction with a Zigbee Bridge and a Smart Speaker  
- Up to 4 luminaire groups can be controlled

Input voltage: 230 V AC, operating voltage: 5 V, wireless frequency: 2.4 GHz  
Wireless standard: Zigbee 3.0, IP rating: IP20, material: plastic, surface/colour:  
white  
Connection: plug-in power supply unit, Cable length: 1,000 mm

**FOR THE SYSTEM TO WORK**  
- Existing Zigbee Bridge (we recommend the Philips Hue Bridge\*)

**FOR LANGUAGE CONTROL TO WORK**  
Existing smart speaker (e.g. Amazon Echo\*\*, not compatible with Apple Home-  
Kit)

\* Philips Hue is a registered trademark of Signify N.V. \*\*  
Amazon Echo and Amazon Alexa are registered trademarks of Amazon.com,  
Inc.



**LED-HOMEBASE**

182

**Must be planned: Starter set LED-ASET4Home60**



**Remote control – as an alternative –  
for Emotion Driver  
Starter set 4-channel control**  
Colour: black

**LED-FBHOME**

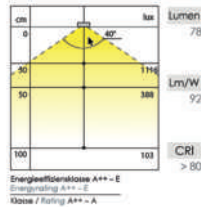
117



# Accessories Lights

Order no.

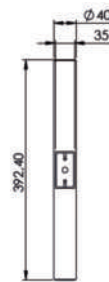
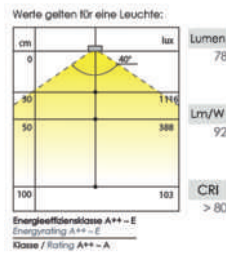
Price



**LED bar pendant light**  
 For the dining and living area  
 Lights 2 W, warm white  
 Aluminium housing, black textured lacquer  
 Integrated ballast  
 230 V  
**This product contains a light source of energy efficiency class F.**

**LED-PL**

253



**LED wall light**  
 For the dining and living area  
 For mounting on walls  
 Lights 2 x 2 W  
 Aluminium housing, black textured lacquer  
 Integrated ballast  
 230 V  
**This product contains a light source of energy efficiency class F.**

**LED-WL**

280



**Ice Emotion LED pendant light**  
 Integrated ballast  
 Infinitely adjustable in height up to 191 cm  
 Homogeneous light, without visible light spots  
 Light 230 V, 18.6 W, length: 120 cm, incl. remote control - 1 channel  
 Aluminium, black  
 Emotion: infinitely variable colour temperature, from warm white (2700 K) to cold white (6500 K), including dimming function

**LED-ICE12**

403



**Kala Emotion LED stand lamp**  
 Integrated ballast  
 Homogeneous light, without visible light spots  
 Light 230 V, 18.6 W, height: 160 cm, incl. remote control - 1 channel  
 Aluminium, black  
 Emotion: infinitely variable colour temperature, from warm white (2700 K) to cold white (6500 K), including dimming function

**LED-KALA 16**

397



**LED lighting for fully integrated dishwasher**  
 for illuminating baskets when pulled out  
 consisting of  
 super-slim LED lighting, 15 W/m  
 Dimensions: height 11.4 mm, width 21 mm  
 Neutral white ca. 4000 K  
 16 mm shelf  
 Mains unit 12 V, 10 W and 2 m cable  
 Including bracket for installation between the left and right-hand unit types  
 IP44 protection class  
 The light is switched on when the dishwasher front is opened  
**This product contains a light source of energy efficiency class F.**

**LED-GSP45**

152

**LED-GSP60**

163

## LED converters

**Important:**  
 The converters LED-K30 and LED-K60 must not be combined with starter and follow-up sets.



LED converter 30 W incl. 6-way distributor

**LED-K 30**

62


LED converter 60 W incl. 6-way distributor

**LED-K 60**

82



## Accessories Lights

	Order no.	Price
 <p><b>ON/OFF switch</b> Stainless steel-coloured melamine With 2 m power supply lead and Euro plug and 2 m power supply lead and Euro coupling</p>	<b>Z 100</b>	63

## Accessories Lighting easi®

Legend: Planning advice Merchandise net

	Order no.	Price
 <p><b>Starter set, D-Motion easi® control, 72W</b> consisting of: 1x easi® driver, 12V DC, 72W 1x easi® Disk remote control / wall switch, including magnetic board holder, infinitely adjustable Colour dimming – combined infinite adjustment of colour temperature and dim- ming level 6-way distributor integrated in easi® Driver Up to 3 channels, at least one easi® driver is required for each channel Memory function: the last setting is saved and remains intact even after a power failure.</p>	<b>LED-ASETEASI 72</b>	213
 <p><b>Starter set, D-Motion easi® control, 36W</b> consisting of: 1x easi® driver, 12V DC, 36W 1x easi® Disk remote control / wall switch, including magnetic board holder, infinitely adjustable Colour dimming – combined infinite adjustment of colour temperature and dim- ming level 6-way distributor integrated in easi® Driver Up to 3 channels, at least one easi® driver is required for each channel Memory function: the last setting is saved and remains intact even after a power failure.</p>	<b>LED-ASETEASI 36</b>	163
 <p><b>Add-on set, D-Motion easi® control, 36W</b> 1x easi® driver, 12V DC, 36W For upgrading to 3 channels, with each channel requiring at least one easi® driver. Each channel can also include several easi® drivers. Memory function: the last setting is saved and remains intact even after a power failure.</p>	<b>LED-FSET EASI 36</b>	110
 <p><b>Add-on set, D-Motion easi® control, 72W</b> 1x easi® driver, 12V DC, 72W For upgrading to 3 channels, with each channel requiring at least one easi® driver. Each channel can also include several easi® drivers. Memory function: the last setting is saved and remains intact even after a power failure.</p>	<b>LED-FSET EASI 72</b>	158
 <p><b>Remote control</b> for an add-on easi system Colour: black</p>	<b>LED-FB-EASI</b>	53

## Single fronts


<b>Accessories Front material</b>	ZU. XL71
<b>Carcase material</b>	ZU. XL71
<b>Ceiling panel</b>	ZU. XL71
<b>Plinth panels</b>	ZU. XL72-ZU. XL73
<b>Accessories</b>	ZU. XL74
<b>Front material</b>	ZU. XL74
<b>Base unit doors</b>	ZU. XL74-ZU. XL75
<b>Base unit doors glass neutral</b>	ZU. XL75
<b>Base unit doors, drawer and pull-out panels</b>	ZU. XL75-ZU. XL76
<b>Pull-out panels and wall unit doors</b>	ZU. XL76
<b>Pull-out panels and wall unit doors</b>	ZU. XL77
<b>Glass doors for wall units</b>	ZU. XL77
<b>Tall unit doors glass neutral</b>	ZU. XL78
<b>Tall unit doors and flap doors</b>	ZU. XL78-ZU. XL79
<b>Flap doors glass neutral</b>	ZU. XL79-ZU. XL80
<b>Standard panel</b>	ZU. XL81
<b>Accessories Worktops</b>	ZU. XL81
<b>Special finish</b>	ZU. XL82-ZU. XL83



## Carcase material

		Order no. W H D	per m <sup>2</sup> , W x H	Hinge side:	Carcase depth	Decor groups								
						M10	M20	M30	M40	M50	M60	M70	M80	M90
<b>Carcase material</b> 16 mm thick, decor on both sides Without edging (unfinished cut) Max. dimensions see section 2			<b>Z 31OK</b> minimum price			63 43	108 43	- -	- -	- -	- -	- -	- -	- -
<b>Carcase material</b> 16 mm thick, decor on both sides With edging finish Max. dimensions see section 2			<b>Z 31MK</b> minimum price			84 43	143 50	292 42	432 43	432 43	432 43	612 42	793 42	- -
<b>Carcase material</b> 19 mm thick, decor on both sides Without edging finish			<b>Z 128 OK</b> minimum price			121 52	- -	- -	- -	- -	- -	- -	- -	- -
<b>Carcase material</b> 19 mm thick, decor on both sides With edging finish			<b>Z 128 MK</b> minimum price			162 52	- -	- -	- -	640 52	- -	640 52	858 52	- -
<b>M 10</b> K M10 laminate	<b>M 20</b> D M20 Laminate decor	<b>M 30</b> I M30 RESOPAL PRO super matt IH M30 HPL PRO PW M30 PRIMEWOOD/Basic Veneeer	<b>M 40</b> A M40 DIRECTLACK matt L M40 DIRECTLACK high-gloss	<b>M 50</b> B M50 Velvet lacquer S M50 microstructure lacquer										
<b>M 60</b> QH M60 SMARTGLAS high-gloss QM M60 SMARTGLAS satin-finish	<b>M 70</b> F M70 veneer / oak / walnut Z M70 Veneer / Bavaria	<b>M 80</b> C1 M80 FENIX stainless-steel look H M80 high gloss-Lacquer MP M80 laqué mat Premium O M80 Veneered	<b>M 90</b>											

## Ceiling panel

<b>Ceiling panel</b> 16 mm thick, as a spacefitter between the wall unit and ceiling		 <i>K max. length 408 cm D max. length 260 cm E max. length 270 cm S/B max. length 270 cm F max. length 270 cm H max. length 270 cm M max. length 270 cm</i>												
10 - 20 cm high		per 10 cm Width												
20.1 - 40 cm high		<b>Z 34</b>				2	3,80	7,20	9,60	9,60	-	9,60	9,60	-
		per 10 cm Width												
		<b>Z 34 H</b>				3,20	4,80	10,90	14,10	14,40	-	14,40	14,40	-
<b>M 10</b> K M10 laminate	<b>M 20</b> D M20 Laminate decor	<b>M 30</b> I M30 RESOPAL PRO super matt IH M30 HPL PRO PW M30 PRIMEWOOD/Basic Veneeer	<b>M 40</b> A M40 DIRECTLACK matt L M40 DIRECTLACK high-gloss	<b>M 50</b> B M50 Velvet lacquer S M50 microstructure lacquer										
<b>M 60</b>	<b>M 70</b> F M70 veneer / oak / walnut Z M70 Veneer / Bavaria	<b>M 80</b> C1 M80 FENIX stainless-steel look H M80 high gloss-Lacquer MP M80 laqué mat Premium O M80 Veneered	<b>M 90</b>											

# Plinth panels

# Decor groups

			Decor groups											
			Order no.	M10	M20	M30	M40	M50	M60	M70	M80	M90	M100	M110
			W H D											
<b>Plinth panels</b> 5, 7.5, 10, 12.5, 15, 17.5, 20 cm high W= 10, 15, 20 cm high 16 mm thick with PVC sealing profile	per 10 cm Width	<b>Z 33</b>	0	1,40	5,50	7,30	7,30	7,30	7,30	7,30	7,30	-	5,20	-
	⚡ <i>K max. length 408 cm / D max. length 260 cm                      E max. length 270 cm / S/B/J max. length 270 cm                      F max. length 270 cm / H max. length 270 cm                      M max. length 270 cm / L/A max. length 260 cm                      I max. length 350 cm / C1 max. length 270 cm                      C max. length 360 cm / O max. length 270 cm                      Q max. length 278 cm / R max. length 270 cm / W max. length 400 cm</i>													
<b>Side plinth plus</b>	Unit price	<b>Z 33SS</b>	33	49	96	110	110	110	110	110	110	-	-	-
<b>Plinth panel as additional order</b>	per 10 cm Width	<b>Z 33Z</b>	2	3,80	7,20	9,60	9,60	9,60	9,60	9,60	9,60	-	7,30	-
<b>Side plinth plus</b>	Unit price	<b>Z 33SS</b>	33	49	96	110	110	110	110	110	110	-	-	-
<b>Premium outside corner for plinth panel mitred</b> Set of 4 suitable for 1.6 mm plinth panels, height 21 cm Laminate finish with sealed surface in the colours  Stainless-steel coloured, sealed  Black uni matt, sealed			⚡ <i>Important!                      Plinth panels must be mitred on site                      Not available for: slatted plinth, waterproof plinth</i>											
	<b>Z33 SOPG A I4</b>		18											
	<b>Z33 SOPG A S4</b>		18											
<b>Plinth panel in louvre-effect</b>	per 10 cm Width	<b>Z 33SOLO</b>	-	-	-	-	-	-	-	-	-	-	-	19
⚡ <i>Note:                      Ventilation cross section of the louvre plinth per 100 cm at                      Plinth height 10 cm: 163.33 cm<sup>2</sup>                      Plinth height 15 cm: 401.66 cm<sup>2</sup>                      Plinth height 20 cm: 435.00 cm<sup>2</sup></i>														
<b>Plinth panel in louvre-effect as additional order</b>	per 10 cm Width	<b>Z 33SOLO Z</b>	-	-	-	-	-	-	-	-	-	-	-	21
<b>Inside corner for plinth panel in louvre-effect</b>	Unit price	<b>Z 33SOLO I</b>	7,30											
<b>Outside corner for plinth panel in louvre-effect</b>	Unit price	<b>Z 33SOLO A</b>	7,30											
<b>Bracket set for laterally indented plinth panel, one side</b> Set comprising 2 brackets and 2 braces (for mounting the plinth on the left or right-hand carcass side)	Unit price	<b>Z33 WESE 80</b>	139											
	Unit price	<b>Z33 WESE 90</b>	144											
	Unit price	<b>Z33 WESE 100</b>	147											
	Unit price	<b>Z33 WESE 120</b>	154											
<b>Bracket set for laterally indented plinth panel, two sides</b> Set comprising 2 brackets and 4 braces (for mounting the plinth on the left or right-hand carcass side)	Unit price	<b>Z33 WESB 80</b>	227											
	Unit price	<b>Z33 WESB 90</b>	232											
	Unit price	<b>Z33 WESB 100</b>	234											
	Unit price	<b>Z33 WESB 120</b>	242											

# Plinth panels

# Decor groups

Order no.  
W H D

M10 M20 M30 M40 M50 M60 M70 M80 M90 M100 M110








K M10 laminate	B M50 Velvet lacquer	QH M60 SMARTGLAS high-gloss	F M70 veneer / oak / walnut	C1 M80 FENIX stainless-steel look
K005S Castell Oak K006P Light Grey K023P Stainless Steel Colour K039G Premium white glossy K039P Premium white K043P Graphite Black K058P Magic-grey K075P Black K076P Macaron K160F Snow White K160G Snow White Gloss K178F White Agate K190S Mammoth oak natural K199S Piemont Oak K216S natural mountain oak K218P Light Pepper K229S Classic Oak K230P Art Pepper K235P Titan Steel K236S Diamond Oak effect K247S Dark Maron effect K248P Light Nude K262S Royal Oak effect K263P Fango K269S Mountain Wood K270S Elegant walnut effect	B006F Light Grey B039F Premium white B043F Graphite Black B058F Magic-grey B075F Black B076F Macaron B099F special colour B160F Snow White B178F White Agate B218F Light Pepper B230F Art Pepper B245F Night Green B248F Light Nude B263F Fango	Q075H Black Q160H Snow White Q178H White Agate Q191H Sand grey Q200H Carrara white Q201H Cream	F039S Premium white F043S Graphite Black F058K silk grey F075S Black F076K Macaron F099K special colour F213K natural F214K coffee brown F218S Light Pepper F230S Art Pepper F231K Walnut Veneer F245S Night Green F248S Light Nude F257K Rosso F258K Gavi F259K Dark oak stained F261K Urban Oak F263S Fango F279K Moderno Rustico oak stained	super matt C023M Stainless Steel Look H M80 high gloss-Lacquer H006H Light Grey H039H Premium white H043H Graphite Black H058H Magic-grey H075H Black H076H Macaron H099H special colour H160H Snow White H178H White Agate H218H Light Pepper H230H Art Pepper H245H Night Green H248H Light Nude H263H Fango
<b>D M20 Laminate decor</b> D039F Premium white matt D147S Burnt Wood D149W Brown concrete effect D160F Snow white matt D176S black Sherwood D178F White Agate matt D187W Concrete effect opal D188W Concrete effect pearl grey D202S Sepia Grey Sherwood D212W graphite concrete effect D224S Bordeaux oak D250S Black Oak effect D251S Seal Oak effect D264S Light oak, grooved look D265S Dark oak, grooved look D271W Natural sandstone effect D272F Jade pastel	<b>RH M50 Velvet lacquer wood texture</b> R006H Light Grey R039H Premium white R043H Graphite Black R058H Magic-grey R075H Black R076H Macaron R099H special colour R160H Snow White R178H White Agate R218H Light Pepper R230H Art Pepper R245H Night Green R248H Light Nude R263H Fango	<b>QM M60 SMARTGLAS satin-finish</b> Q075M Black Q160M Snow White Q178M White Agate Q191M Sand grey Q192M Taupe Q200M Carrara white Q201M Cream Q234M Carbon metallic satin-finish Q244M Aqua Q254M Black metallic Q255M Champagne metallic Q258M Grey metallic Q277M Silk Metallic Q278M Bronze Metallic	<b>V M70 Velvet lacquer textured</b> V182W Silver Metallic V183W Gold Metallic V194W Copper Metallic V195W Bronze Metallic V235W Titan Steel metallic V246W Basalt Metallic	<b>MP M80 laqué mat Premium</b> MP006 Light Grey MP039 Premium white MP043 Graphite Black MP058 Magic-grey MP075 Black MP076 Macaron MP099 special colour MP160 Snow White MP178 White Agate MP218 Light Pepper MP230 Art Pepper MP245 Night Green MP248 Light Nude MP263 Fango
<b>I M30 RESOPAL PRO super matt</b> I039M Premium white I075M Black I076M Macaron powder I138M Titanium grey I139M Jura Grey I140M anthracite I141M cool white I240M Light Powder I241M Dark Powder I253M Moonlight Green I267M brown powder I268M nature powder	<b>RW M50 Velvet lacquer sparkle effect</b> R006W Light Grey R039W Premium white R043W Graphite Black R058W Magic-grey R075W Black R076W Macaron R099W special colour R160W Snow White R178W White Agate R218W Light Pepper R230W Art Pepper R245W Night Green R248W Light Nude R263W Fango		<b>Z M70 Veneer / Bavaria</b> Z039S Premium white Z043S Graphite Black Z058K silk grey Z075S Black Z076K Macaron Z099K special colour Z213K natural Z214K coffee brown Z218S Light Pepper Z230S Art Pepper Z245S Night Green Z248S Light Nude Z258K Gavi oak Z259K Dark oak stained Z261K Urban Oak Z263S Fango Z279K Moderno Rustico oak stained	<b>O M80 Veneered</b> O170S Antique Oak O197S Light Spessart oak O215S larch O232S Leached Spessart oak O233S Honey Spessart oak O259K Dark oak stained, brushed
<b>IH M30 HPL PRO</b> I273H Natural onyx effect I274H Navyblue I280H Smoke Powder I281H Ferro black gold	<b>S M50 microstructure lacquer</b> S006P Light Grey S039P Premium white S043P Graphite Black S058P Magic-grey S075P Black S076P Macaron S099P special colour S160P Snow White S178P White Agate S218P Light Pepper S230P Art Pepper S245P Night Green S248P Light Nude S263P Fango			<b>W M100 Laminate Waterproof</b> W023MSt.Steel Coloured Foiled
<b>PW M30 PRIMEWOOD/Basic Veneer</b> PW258 Gavi oak Basic veneer PW259 Dark oak basic veneer <b>A M40 DIRECTLACK matt</b> A039M Premium white A043M Graphite Black A075M Black A076M Macaron A160M Snow White A178M White Agate A218M Light Pepper matt A230M Art Pepper A248M Light Nude A263M Fango				<b>E1 M110 Lamella effect</b> E023F Aluminium Inox lamella effect E075F Aluminium black lamella effect
<b>L M40 DIRECTLACK high-gloss</b> L039H Premium white L076H Macaron L160H Snow White L178H White Agate L218H Light Pepper L248H Light Nude				

# Front material

	Order no. W H D	per m <sup>2</sup> , W x H	Hinge side:	Carcase depth	Price groups								
					1	2	3	4	5	6	7	8	9
<b>Front material Vertical</b> Max. dimensions see section 2 Edge type corresponds with model number, without drill holes, without fittings		per m <sup>2</sup> , W x H <b>FM</b> minimum price			162	292	476	764	793	816	1105	1216	-
					52	101	156	180	180	180	318	350	-
Available for: ARTE-B, ARTE-S, ATLANTA-B, ATLANTA-S, BAVARIA, BERGEN, CASA-B, CASTELLO, CHALET-B, CHALET-S, CHICAGO, EDITION, FENIX INOX, FLORENZ, FRAME, GENT, LUGANO, LUX-B, MALMÖ, MONTANA, MPX, NEW OPAL-M, NOBEL-B, NOBEL-S, OPAL-H, ORLANDO-B, ORLANDO-S, OSLO 15, PALAZZO, PALERMO-B, PALERMO-S, PRIMEWOOD TOP, PUR, RIVA, ROMA-B, ROMA-S, RUSTY OAK, SHERWOOD, SIGNUM-B, SMART, SMART MIRROR, SMART-M, SOFIE-B, SOFIE-S, TALEA, TESSIN 15, TIM, TIM 15, TOP, VILLAGE 15-B, VILLAGE 15-S, VINO, YORK-B, YORK-S													
<b>Front material Horizontal</b> Max. dimensions see section 2 Edge type corresponds with model number, without drill holes, without fittings		per m <sup>2</sup> , W x H <b>FM2</b> minimum price			162	292	-	-	793	816	1105	1216	-
					52	101	-	-	180	180	318	350	-
Available for: GARDA, MODENA, MUNICH, NEVADA, PADUA, TREND													
<b>Front material</b> Max. dimensions see section 2 Edge type corresponds with model number, without drill holes, without fittings		per m <sup>2</sup> , W x H <b>FMR</b> minimum price			-	-	319	-	-	-	1105	-	-
					-	-	101	-	-	-	318	-	-
Available for: ALU TEC RP, HPL PRO, RESOPAL, RESOPAL PRO, RESOPAL PRO EDGE													

## Base unit doors









The articles on this page do not include any handles, mounting plates or hinges. Please order these separately.

126 516 	<b>Base unit door</b> Pinned door with drawer panel With fitting drill hole Without fitting, Height: 646 mm 126 mm + 516 mm = 646 mm	E-TUVO30 65	R/L	96	105	122	172	226	270	298	328	-		
		E-TUVO40 65	R/L	105	120	140	194	259	301	330	363	-		
		E-TUVO45 65	R/L	110	128	148	209	277	320	351	386	-		
		E-TUVO50 65	R/L	112	140	159	220	295	341	374	411	-		
		E-TUVO60 65	R/L	119	155	176	245	325	378	418	460	-		
126 646 	<b>Base unit door</b> Pinned door with drawer panel With fitting drill hole Without fitting, Height: 776 mm 126 mm + 646 mm = 776 mm	E-TUVO30 78	R/L	100	116	137	187	236	286	314	345	-		
		E-TUVO40 78	R/L	110	137	156	214	287	335	368	405	-		
		E-TUVO45 78	R/L	116	145	165	228	306	352	384	422	-		
		E-TUVO50 78	R/L	120	156	179	244	325	376	414	455	-		
		E-TUVO60 78	R/L	131	178	199	267	366	441	484	532	-		
516 	<b>Base unit door</b> With fitting drill hole Without fitting, Height: 516 mm	E-TUO 30 52	R/L	51	54	71	100	128	172	188	207	-		
		E-TUO 40 52	R/L	54	71	86	118	157	190	210	231	-		
		E-TUO 45 52	R/L	60	77	96	128	169	207	227	250	-		
		E-TUO 50 52	R/L	63	86	103	137	181	223	246	271	-		
		E-TUO 60 52	R/L	66	100	118	156	209	250	271	298	-		
646 	<b>Base unit door</b> With fitting drill hole Without fitting, Height: 646 mm	E-TUO 20 65	R/L	50	52	65	94	116	165	181	199	-		
		E-TUO 25 65	R/L	52	57	73	105	133	178	194	213	-		
		E-TUO 30 65	R/L	54	68	84	116	140	183	204	224	-		
		E-TUO 40 65	R/L	63	85	105	137	181	226	249	274	-		
		E-TUO 45 65	R/L	66	93	112	146	199	236	260	286	-		
		E-TUO 50 65	R/L	70	105	123	159	216	258	286	315	-		
		E-TUO 60 65	R/L	75	122	143	179	249	308	340	374	-		
		 width 20 cm: FRAME, VILLAGE 15-S, VILLAGE 15-B, CHALET-S, CHALET-B, OSLO 15, TESSIN 15, BERGEN, LUGANO, CASTELLO, VIVA, TIM 15 are supplied with smooth fronts. width 25 cm: FRAME are supplied with smooth fronts.												
		776 	<b>Base unit door</b> With fitting drill hole Without fitting, Height: 776 mm	E-TUO 20 78	R/L	52	54	73	105	129	170	186	205	-
				E-TUO 25 78	R/L	57	68	85	117	147	183	204	224	-
E-TUO 30 78	R/L			60	77	98	129	161	207	227	250	-		
E-TUO 40 78	R/L			70	101	120	157	209	251	275	303	-		
E-TUO 45 78	R/L			72	111	133	169	228	281	306	337	-		
E-TUO 50 78	R/L			83	122	144	180	250	301	331	364	-		
E-TUO 60 78	R/L			84	144	166	207	288	363	398	438	-		
 width 20 cm: FRAME, VILLAGE 15-S, VILLAGE 15-B, CHALET-S, CHALET-B, OSLO 15, TESSIN 15, BERGEN, LUGANO, CASTELLO, VIVA, TIM 15 are supplied with smooth fronts. width 25 cm: FRAME are supplied with smooth fronts.														






## Base unit doors

The articles on this page do not include any handles, mounting plates or hinges. Please order these separately.

	Order no. W H D	Hinge side: Carcase depth	Price groups								
			1	2	3	4	5	6	7	8	9
 <p><b>Base unit door</b> With fitting drill hole Without fitting, Height: 906 mm</p>	<b>E-TUO 20 91</b>	R/L	60	65	83	114	136	181	200	220	-
	<b>E-TUO 25 91</b>	R/L	63	74	96	128	159	195	217	239	-
	<b>E-TUO 30 91</b>	R/L	64	87	110	143	180	229	253	278	-
	<b>E-TUO 40 91</b>	R/L	72	116	138	173	228	290	319	351	-
	<b>E-TUO 45 91</b>	R/L	75	126	149	187	251	317	349	384	-
	<b>E-TUO 50 91</b>	R/L	83	141	164	204	271	366	402	442	-
	<b>E-TUO 60 91</b>	R/L	89	164	191	231	320	437	480	528	-
	 <b>width 20 cm: FRAME, VILLAGE 15-S, VILLAGE 15-B, CHALET-S, CHALET-B, OSLO 15, TESSIN 15, BERGEN, LUGANO, CASTELLO, VIVA, TIM 15 are supplied with smooth fronts.</b> <b>width 25 cm: FRAME are supplied with smooth fronts.</b>										
 <p><b>Base unit glass door</b> 64.6 cm high</p>	<b>E-TUG 45 65</b>	R/L	192	268	282	292	303	334	367	404	-
	<b>E-TUG 50 65</b>	R/L	194	277	295	300	321	357	391	430	-
	<b>E-TUG 60 65</b>	R/L	195	299	315	322	342	409	445	490	-
	 <b>available glass versions:</b> 90 = clear glass 93 = black glass 92 = matt glass 88 = Linea glass										
 <p><b>Base unit glass door</b> 77.6 cm high</p>	<b>E-TUG 45 78</b>	R/L	211	288	298	299	320	376	413	454	-
	<b>E-TUG 50 78</b>	R/L	213	300	312	312	347	402	440	484	-
	<b>E-TUG 60 78</b>	R/L	215	321	345	360	393	464	506	557	-
	 <b>available glass versions:</b> 90 = clear glass 93 = black glass 92 = matt glass 88 = Linea glass										
 <p><b>Base unit glass door</b> 90.6 cm high</p>	<b>E-TUG 45 91</b>	R/L	250	306	320	332	356	416	456	502	-
	<b>E-TUG 50 91</b>	R/L	252	320	338	351	384	469	513	564	-
	<b>E-TUG 60 91</b>	R/L	254	345	398	409	442	541	595	655	-
	 <b>available glass versions:</b> 90 = clear glass 93 = black glass 92 = matt glass 88 = Linea glass										


## Base unit doors glass neutral

The articles on this page do not include any handles, mounting plates or hinges. Please order these separately.

	Order no. W H D	Hinge side: Carcase depth	Glass groups					
			G1	G2	G2S	G5S	G6	
 <p><b>Glass front for base unit</b> -neutral- With fitting drill hole With fitting, Height: 646 mm</p>	<b>E-TUD 45 65</b>	R/L	-	322	322	359	-	
	<b>E-TUD 50 65</b>	R/L	-	337	337	367	-	
	<b>E-TUD 60 65</b>	R/L	-	366	366	412	-	
 <p><b>Glass front for base unit</b> -neutral- With fitting drill hole With fitting, Height: 776 mm</p>	<b>E-TUD 45 78</b>	R/L	-	352	352	392	-	
	<b>E-TUD 50 78</b>	R/L	-	364	364	413	-	
	<b>E-TUD 60 78</b>	R/L	-	392	392	455	-	
 <p><b>Glass front for base unit</b> -neutral- With fitting drill hole With fitting, Height: 906 mm</p>	<b>E-TUD 45 91</b>	R/L	-	371	371	426	-	
	<b>E-TUD 50 91</b>	R/L	-	389	389	449	-	
	<b>E-TUD 60 91</b>	R/L	-	426	426	496	-	
<b>G 1</b>	<b>G 2</b>	<b>G 2S</b>						
G1 AKTIVglass frame	G2 Design front	G2S aluminium, framed glass door						
<b>G 5</b>	<b>G 5S</b>	<b>G 6</b>						
	G5S aluminium, door with mullion	G6 NEW SALON						

## Base unit doors, drawer and pull-out panels

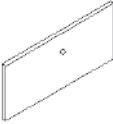
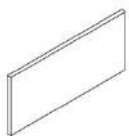

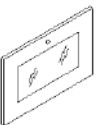

The articles on this page do not include any handles, mounting plates or hinges. Please order these separately.

 <p><b>Drawer panel</b> Top With fitting drill hole With adapter Height: 126 mm</p>	<b>E-SKBO30 13</b>		46	49	51	72	98	100	109	120	-
	<b>E-SKBO40 13</b>		49	50	52	76	105	112	121	133	-
	<b>E-SKBO45 13</b>		50	51	53	78	109	114	123	135	-
	<b>E-SKBO50 13</b>		51	52	54	83	113	120	131	144	-
	<b>E-SKBO60 13</b>		53	54	59	87	118	133	144	158	-
	<b>E-SKBO80 13</b>		59	65	68	101	134	144	158	174	-
	<b>E-SKBO90 13</b>		64	69	72	108	140	160	175	193	-
	<b>E-SKBO100 13</b>		66	73	77	113	146	173	190	209	-
	<b>E-SKBO120 13</b>		70	84	88	124	161	200	218	240	-

## Base unit doors, drawer and pull-out panels

The articles on this page do not include any handles, mounting plates or hinges. Please order these separately.

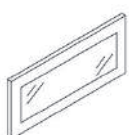

Order no.  
W H D

	Hinge side:	Carcass depth	Price groups								
			1	2	3	4	5	6	7	8	9
175  <b>Drawer panel</b> Top With fitting drill hole With adapter Height: 175 mm			<b>E-SKBO6018</b>								
			60	65	83	113	159	192	206	227	-
256  <b>Pull-out panel</b> Top With fitting drill hole With fitting, Height: 256 mm			<b>E-AZBO30 26</b>								
			49	50	63	85	118	159	172	189	-
			<b>E-AZBO40 26</b>								
			53	54	70	96	133	162	178	196	-
			<b>E-AZBO45 26</b>								
			54	59	72	101	138	167	181	199	-
			<b>E-AZBO50 26</b>								
			57	64	75	107	144	179	194	213	-
			<b>E-AZBO60 26</b>								
			63	70	85	116	159	182	200	220	-
			<b>E-AZBO80 26</b>								
			71	98	105	136	183	220	239	263	-
			<b>E-AZBO90 26</b>								
			75	108	111	144	199	232	255	281	-
			<b>E-AZBO100 26</b>								
			83	116	119	156	211	252	275	303	-
			<b>E-AZBO120 26</b>								
			91	136	139	173	237	301	330	363	-
386  <b>Pull-out panel</b> Top With fitting drill hole With fitting, Height: 386 mm			<b>E-AZBO30 39</b>								
			59	60	72	100	122	165	180	198	-
			<b>E-AZBO40 39</b>								
			64	71	85	114	143	182	200	220	-
			<b>E-AZBO45 39</b>								
			66	75	89	121	153	193	213	234	-
			<b>E-AZBO50 39</b>								
			68	83	98	128	162	199	217	239	-
			<b>E-AZBO60 39</b>								
			69	91	110	141	181	220	239	263	-
			<b>E-AZBO80 39</b>								
			75	136	148	170	223	262	290	319	-
			<b>E-AZBO90 39</b>								
			82	146	162	181	245	297	323	355	-
			<b>E-AZBO100 39</b>								
			86	160	175	194	261	314	343	377	-
			<b>E-AZBO120 39</b>								
			98	186	199	224	302	377	414	455	-
256  <b>Pull-out panel with glass</b> Top With fitting drill hole With fitting, Height: 256 mm			<b>E-AZBGO 60 26</b>								
			163	173	188	195	211	226	248	273	-
			<b>E-AZBGO 90 26</b>								
			230	251	262	269	293	302	331	364	-
			💡 available glass versions: 90 = clear glass 93 = black glass 92 = matt glass 88 = Linea glass								
386  <b>Pull-out panel with glass</b> Top With fitting drill hole With fitting, Height: 386 mm			<b>E-AZBGO 60 39</b>								
			182	252	263	271	290	301	330	363	-
			<b>E-AZBGO 90 39</b>								
			234	290	303	323	343	378	416	458	-
			💡 available glass versions: 90 = clear glass 93 = black glass 92 = matt glass 88 = Linea glass								

## Pull-out panels and wall unit doors

The articles on this page do not include any handles, mounting plates or hinges. Please order these separately.

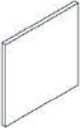







Order no.  
W H D

	Hinge side:	Carcass depth	Glass groups					
			G1	G2	G2S	G5S	G6	
256  <b>Pull-out panel with glass</b> Design glass -neutral- Top With fitting drill hole With fitting, Height: 256 mm			<b>E-AZBDO 45 26</b>					
			-	250	250	254	-	
			<b>E-AZBDO 50 26</b>					
			-	257	257	261	-	
			<b>E-AZBDO 60 26</b>					
			-	271	271	277	-	
			<b>E-AZBDO 80 26</b>					
			-	307	307	302	-	
			<b>E-AZBDO 90 26</b>					
			-	321	321	328	-	
			<b>E-AZBDO 10 26</b>					
			-	341	341	351	-	
			<b>E-AZBDO 12 26</b>					
			-	370	370	381	-	
386  <b>Pull-out panel with glass</b> Design glass -neutral- Top With fitting drill hole With fitting, Height: 386 mm			<b>E-AZBDO 45 39</b>					
			-	273	273	282	-	
			<b>E-AZBDO 50 39</b>					
			-	283	283	300	-	
			<b>E-AZBDO 60 39</b>					
			-	304	304	320	-	
			<b>E-AZBDO 80 39</b>					
			-	335	335	357	-	
			<b>E-AZBDO 90 39</b>					
			-	367	367	398	-	
			<b>E-AZBDO 10 39</b>					
			-	396	396	438	-	
			<b>E-AZBDO 12 39</b>					
			-	458	458	517	-	

G 1	G 2	G 2S
G1 AKTIVglass frame	G2 Design front	G2S aluminium, framed glass door
G 5	G 5S	G 6
	G5S aluminium, door with mullion	G6 NEW SALON







## Pull-out panels and wall unit doors

The articles on this page do not include any handles, mounting plates or hinges. Please order these separately.

	Order no. W H D	Hinge side: Carcass depth	Price groups								
			1	2	3	4	5	6	7	8	9
<b>386</b>  <b>Wall unit door</b> With fitting drill hole Without fitting, Height: 386 mm	<b>E-THO 30 39</b>	R/L	46	47	59	85	109	149	167	184	-
	<b>E-THO 40 39</b>	R/L	49	57	71	100	129	170	186	205	-
	<b>E-THO 45 39</b>	R/L	51	64	75	108	139	180	199	219	-
	<b>E-THO 50 39</b>	R/L	52	69	83	114	147	183	204	224	-
	<b>E-THO 60 39</b>	R/L	53	77	96	128	169	207	227	250	-
<b>516</b>  <b>Wall unit door</b> With fitting drill hole Without fitting, Height: 516 mm	<b>E-THO 30 52</b>	R/L	51	54	71	100	128	172	188	207	-
	<b>E-THO 40 52</b>	R/L	54	71	86	118	157	190	210	231	-
	<b>E-THO 45 52</b>	R/L	60	77	96	128	169	207	227	250	-
	<b>E-THO 50 52</b>	R/L	63	86	103	137	181	223	246	271	-
	<b>E-THO 60 52</b>	R/L	66	100	118	156	209	250	271	298	-
<b>646</b>  <b>Wall unit door</b> With fitting drill hole Without fitting, Height: 646 mm	<b>E-THO 20 65</b>	R/L	50	52	65	94	116	165	181	199	-
	<b>E-THO 25 65</b>	R/L	52	57	73	105	133	178	194	213	-
	<b>E-THO 30 65</b>	R/L	54	68	84	116	140	183	204	224	-
	<b>E-THO 40 65</b>	R/L	63	85	105	137	181	226	249	274	-
	<b>E-THO 45 65</b>	R/L	66	93	112	146	199	236	260	286	-
	<b>E-THO 50 65</b>	R/L	70	105	123	159	216	258	286	315	-
	<b>E-THO 60 65</b>	R/L	75	122	143	179	249	308	340	374	-
	 <b>width 20 cm: FRAME, VILLAGE 15-S, VILLAGE 15-B, CHALET-S, CHALET-B, OSLO 15, TESSIN 15, BERGEN, LUGANO, CASTELLO, VIVA, TIM 15 are supplied with smooth fronts.</b> <b>width 25 cm: FRAME are supplied with smooth fronts.</b>										
<b>776</b>  <b>Wall unit door</b> With fitting drill hole Without fitting, Height: 776 mm	<b>E-THO 20 78</b>	R/L	52	54	73	105	129	170	186	205	-
	<b>E-THO 25 78</b>	R/L	57	68	85	117	147	183	204	224	-
	<b>E-THO 30 78</b>	R/L	60	77	96	129	161	207	227	250	-
	<b>E-THO 40 78</b>	R/L	70	101	120	157	209	251	275	303	-
	<b>E-THO 45 78</b>	R/L	72	111	133	169	227	281	306	337	-
	<b>E-THO 50 78</b>	R/L	83	122	144	180	250	301	331	364	-
	<b>E-THO 60 78</b>	R/L	84	144	166	207	288	363	398	438	-
 <b>width 20 cm: FRAME, VILLAGE 15-S, VILLAGE 15-B, CHALET-S, CHALET-B, OSLO 15, TESSIN 15, BERGEN, LUGANO, CASTELLO, VIVA, TIM 15 are supplied with smooth fronts.</b> <b>width 25 cm: FRAME are supplied with smooth fronts.</b>											
<b>906</b>  <b>Wall unit door</b> With fitting drill hole Without fitting, Height: 906 mm	<b>E-THO 20 91</b>	R/L	60	65	83	114	136	181	200	220	-
	<b>E-THO 25 91</b>	R/L	63	74	96	128	159	195	217	239	-
	<b>E-THO 30 91</b>	R/L	64	87	110	143	180	229	253	278	-
	<b>E-THO 40 91</b>	R/L	72	116	138	173	228	290	319	351	-
	<b>E-THO 45 91</b>	R/L	75	126	149	187	251	317	349	384	-
	<b>E-THO 50 91</b>	R/L	83	141	164	204	271	366	402	442	-
	<b>E-THO 60 91</b>	R/L	89	164	191	231	320	437	480	528	-
 <b>width 20 cm: FRAME, VILLAGE 15-S, VILLAGE 15-B, CHALET-S, CHALET-B, OSLO 15, TESSIN 15, BERGEN, LUGANO, CASTELLO, VIVA, TIM 15 are supplied with smooth fronts.</b> <b>width 25 cm: FRAME are supplied with smooth fronts.</b>											

## Glass doors for wall units

The articles on this page do not include any handles, mounting plates or hinges. Please order these separately.

	Order no. W H D	Hinge side: Carcass depth	Price groups								
			1	2	3	4	5	6	7	8	9
<b>646</b>  <b>Glass door for wall unit</b> With hinges Height: 646 mm	<b>E-THG 45 65</b>	R/L	192	268	282	292	303	334	367	404	-
	<b>E-THG 50 65</b>	R/L	194	277	295	300	321	357	391	430	-
	<b>E-THG 60 65</b>	R/L	195	299	315	322	342	409	445	490	-
 <b>available glass versions:</b> 90 = clear glass 93 = black glass 92 = matt glass 88 = Linea glass											
<b>776</b>  <b>Glass door for wall unit</b> With hinges Height: 776 mm	<b>E-THG 45 78</b>	R/L	211	288	298	299	320	376	413	454	-
	<b>E-THG 50 78</b>	R/L	213	300	312	312	347	402	440	484	-
	<b>E-THG 60 78</b>	R/L	215	321	345	360	393	464	506	557	-
 <b>available glass versions:</b> 90 = clear glass 93 = black glass 92 = matt glass 88 = Linea glass											
<b>906</b>  <b>Glass door for wall unit</b> With hinges Height: 906 mm	<b>E-THG 45 91</b>	R/L	250	306	320	332	356	416	456	502	-
	<b>E-THG 50 91</b>	R/L	252	320	338	351	384	469	513	564	-
	<b>E-THG 60 91</b>	R/L	254	345	398	409	442	541	595	655	-
 <b>available glass versions:</b> 90 = clear glass 93 = black glass 92 = matt glass 88 = Linea glass											


## Tall unit doors glass neutral

The articles on this page do not include any handles, mounting plates or hinges. Please order these separately.

Order no.  
W H D

Hinge side:	Carcase depth	Glass groups					
		G1	G2	G2S	G5S	G6	
R/L		-	322	322	359	-	
R/L		-	296	296	352	-	
R/L		-	306	306	360	-	
R/L		-	337	337	367	-	
R/L		-	366	366	413	-	
R/L		-	329	329	403	-	
R/L		-	352	352	392	-	
R/L		-	319	319	384	-	
R/L		-	329	329	403	-	
R/L		-	364	364	413	-	
R/L		-	392	392	455	-	
R/L		-	349	349	444	-	
R/L		-	371	371	426	-	
R/L		-	338	338	366	-	
R/L		-	349	349	441	-	
R/L		-	389	389	449	-	
R/L		-	426	426	496	-	
R/L		-	374	374	487	-	

**646**  **Glass front for tall unit**  
Design glass  
-neutral-  
With fitting drill hole  
With fitting,  
Height: 646 mm

**776**  **Glass front for tall unit**  
Design glass  
-neutral-  
With fitting drill hole  
With fitting,  
Height: 776 mm

**906**  **Glass front for tall unit**  
Design glass  
-neutral-  
With fitting drill hole  
With fitting,  
Height: 906 mm


G 1	G 2	G 2S
G1 AKTIVglass frame	G2 Design front	G2S aluminium, framed glass door
G 5	G 5S	G 6
	G5S aluminium, door with mullion	G6 NEW SALON


## Tall unit doors and flap doors


The articles on this page do not include any handles, mounting plates or hinges. Please order these separately.


Order no.  
W H D


Hinge side:	Carcase depth	Price groups								
		1	2	3	4	5	6	7	8	9
R/L		89	111	135	165	210	270	296	326	-
R/L		110	156	181	222	293	394	431	474	-
R/L		110	156	181	222	293	394	431	474	-
R/L		114	170	199	234	322	426	469	516	-
R/L		117	199	230	269	372	500	550	605	-
R/L		96	124	148	184	233	299	326	359	-
R/L		119	173	200	244	323	436	478	526	-
R/L		119	173	200	244	323	436	478	526	-
R/L		123	191	222	260	356	473	517	569	-
R/L		125	224	255	298	412	554	608	669	-
R/L		101	138	164	199	261	325	360	396	-
R/L		122	191	224	260	354	472	516	568	-
R/L		122	191	224	260	354	472	516	568	-
R/L		126	212	245	285	395	516	563	619	-
R/L		131	245	282	323	461	621	684	752	-
R/L		107	147	179	213	283	356	389	428	-
R/L		136	208	244	283	392	515	562	618	-
R/L		136	208	244	283	392	515	562	618	-
R/L		143	229	265	304	429	570	625	688	-
R/L		159	267	307	351	498	664	731	804	-
R/L		202	237	278	340	403	494	534	587	-
R/L		227	301	348	420	536	630	693	762	-
R/L		227	301	348	420	536	643	693	762	-
R/L		246	325	369	441	580	685	744	818	-
R/L		249	369	416	494	658	805	873	960	-
R/L		205	248	287	354	422	517	560	616	-
R/L		230	319	365	437	559	679	736	810	-
R/L		230	319	365	437	559	679	736	810	-
R/L		246	345	390	465	602	747	814	895	-
R/L		254	390	438	519	690	880	957	1053	-


**1036**  **Tall unit door**  
With fitting drill hole  
Without fitting,  
Height: 1036 mm

**1166**  **Tall unit door**  
With fitting drill hole  
Without fitting,  
Height: 1166 mm

**1296**  **Tall unit door**  
With fitting drill hole  
Without fitting,  
Height: 1296 mm





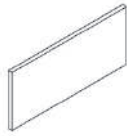

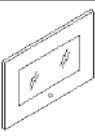

**1426**  **Tall unit door**  
With fitting drill hole  
Without fitting,  
Height: 1426 mm

**1556**  **Tall unit door**  
with tightening fitting  
With fitting drill hole  
Without fitting,  
Height: 1556 mm

**1686**  **Tall unit door**  
with tightening fitting  
With fitting drill hole  
Without fitting,  
Height: 1686 mm

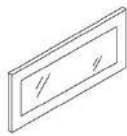
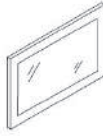
## Tall unit doors and flap doors

The articles on this page do not include any handles, mounting plates or hinges. Please order these separately.

	Order no. W H D	Hinge side: Carcase depth	Price groups									
			1	2	3	4	5	6	7	8	9	
 <b>Tall unit door</b> with tightening fitting With fitting drill hole Without fitting, Height: 1816 mm		E-TGUO30182	R/L	232	275	314	378	455	563	611	672	-
		E-TGUO40182	R/L	261	349	392	472	603	754	818	900	-
		E-TGUO45182	R/L	265	349	392	472	603	754	818	900	-
		E-TGUO50182	R/L	276	374	425	499	653	810	885	974	-
		E-TGUO60182	R/L	283	426	480	558	741	944	1030	1133	-
 <b>Tall unit door</b> with tightening fitting With fitting drill hole Without fitting, Height: 1946 mm		E-TGUO30195	R/L	237	284	328	395	477	586	634	697	-
		E-TGUO40195	R/L	273	366	414	493	631	797	863	949	-
		E-TGUO45195	R/L	273	366	414	493	631	797	863	949	-
		E-TGUO50195	R/L	286	394	445	523	687	854	929	1022	-
		E-TGUO60195	R/L	290	447	502	585	782	996	1087	1196	-
 <b>Tall unit door</b> with tightening fitting With fitting drill hole Without fitting, Height: 2076 mm		E-TGUO30208	R/L	244	298	343	410	502	614	666	733	-
		E-TGUO40208	R/L	277	379	438	510	661	832	903	993	-
		E-TGUO45208	R/L	277	379	438	510	661	832	903	993	-
		E-TGUO50208	R/L	290	416	471	547	724	899	976	1074	-
		E-TGUO60208	R/L	297	471	531	611	830	1064	1160	1276	-
 <b>Tall unit door</b> with tightening fitting With fitting drill hole Without fitting, Height: 2206 mm		E-TGUO30221	R/L	248	307	359	423	526	644	696	766	-
		E-TGUO40221	R/L	288	400	459	534	701	875	950	1045	-
		E-TGUO45221	R/L	288	400	459	534	701	875	950	1045	-
		E-TGUO50221	R/L	306	432	490	566	760	953	1038	1142	-
		E-TGUO60221	R/L	323	491	555	639	867	1108	1208	1329	-
 <b>Flap door</b> With fitting drill hole Without fitting, Height: 256 mm		E-KLO100 26		83	116	119	156	211	252	275	303	-
		E-KLO 30 26		49	50	63	85	118	159	172	189	-
		E-KLO 40 26		53	54	70	96	133	162	178	196	-
		E-KLO 45 26		54	59	72	101	138	167	181	199	-
		E-KLO 50 26		57	64	75	107	144	179	194	213	-
		E-KLO 60 26		63	70	85	116	159	182	200	220	-
		E-KLO 80 26		71	98	105	136	183	220	239	263	-
		E-KLO 90 26		75	108	111	144	199	232	255	281	-
 <b>Flap door</b> With fitting drill hole Without fitting, Height: 386 mm		E-KLO 30 39		59	60	72	100	122	165	180	198	-
		E-KLO 40 39		64	71	85	114	143	182	200	220	-
		E-KLO 45 39		66	75	89	121	153	193	213	234	-
		E-KLO 50 39		68	83	98	128	162	199	217	239	-
		E-KLO 60 39		69	91	110	141	181	220	239	263	-
		E-KLO 80 39		75	136	148	170	223	262	290	319	-
		E-KLO 90 39		82	146	162	181	245	297	323	355	-
		E-KLO100 39		86	160	175	194	261	314	343	377	-
		E-KLO120 39		98	186	199	224	302	377	414	455	-
 <b>Glass flap door</b> With fitting drill hole Without fitting, Height: 256 mm		E-KLG 45 26		156	161	175	183	193	206	224	246	-
		E-KLG 50 26		162	165	181	190	207	222	244	268	-
		E-KLG 60 26		163	173	188	195	211	226	248	273	-
		E-KLG 90 26		230	251	262	269	293	302	331	364	-
				 available glass versions: 90 = clear glass 93 = black glass 92 = matt glass 88 = Linea glass								

## Flap doors glass neutral

The articles on this page do not include any handles, mounting plates or hinges. Please order these separately.

	Order no. W H D	Hinge side: Carcase depth	Glass groups						
			G1	G2	G2S	G5S	G6		
 <b>Glass flap door</b> Design glass -neutral- With fitting drill hole Without fitting, Height: 256 mm		E-KLD 45 26		-	250	250	254	-	
		E-KLD 50 26		-	257	257	261	-	
		E-KLD 60 26		-	271	271	277	-	
		E-KLD 80 26		-	307	307	315	-	
		E-KLD 90 26		-	321	321	328	-	
		E-KLD100 26		-	341	341	351	-	
		E-KLD120 26		-	370	370	381	-	
 <b>Glass flap door</b> Design glass -neutral- With fitting drill hole Without fitting, Height: 386 mm		E-KLD 45 39		-	273	273	282	-	
		E-KLD 50 39		-	283	283	300	-	
		E-KLD 60 39		-	304	304	320	-	
		E-KLD 80 39		-	335	335	357	-	
		E-KLD 90 39		-	367	367	398	-	
		E-KLD100 39		-	396	396	438	-	
		E-KLD120 39		-	458	458	517	-	

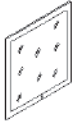
# Flap doors glass neutral

The articles on this page do not include any handles, mounting plates or hinges. Please order these separately.

Order no.  
W H D

		Glass groups					
Hinge side:	Carcase depth	G1	G2	G2S	G5S	G6	
		-	465	465	545	-	
		-	329	329	407	-	

646



**Glass flap door**  
Design glass  
-neutral-  
With fitting drill hole  
Without fitting,  
Height: 646 mm

**E-KLD 90 65**  
**E-LKLD90 65**

G 1	G 2	G 2S
G1 AKTIVglass frame	G2 Design front	G2S aluminium, framed glass door

G 5	G 5S	G 6
	G5S aluminium, door with mullion	G6 NEW SALON



# Standard panel




	Order no. W H D	Unit price	Decor groups																			
			M10	M20	M30	M40	M50	M60	M70	M80	M90											
<b>Standard panel, 16 mm thick</b> Decor on both sides, without edging finish		Unit price																				
		<b>SA83K162</b>	188	298	728	481	-	972	-	1018	-											
		Maximum dimensions see section 2																				
<b>Edging to fit 16 mm carcass material 1.3 mm thick, 19 mm wide</b> 1.3 mm thick, 19 mm wide Without hot-melt adhesive	1 roll = 225 running metres (RM)	per 1 m																				
		<b>SA81K13190</b>	3,70	7,20	7,20	7,20	-	7,20	-	7,20	-											
		Unit price																				
		<b>SA81K13190R</b>	390	519	519	519	-	519	-	519	-											
<b>Standard panel, 19 mm thick</b> Decor on both sides, without edging finish		Unit price																				
		<b>SA83K192</b>	234	-	-	-	-	-	-	-	-	-										
		Maximum dimensions see section 2																				
<b>Edging to fit 19 mm carcass material 1.3 mm thick, 22 mm wide</b> 1.3 mm thick, 22 mm wide Without hot-melt adhesive	1 roll = 175 running metres (RM)	per 1 m																				
		<b>SA81K13220</b>	7,20	-	-	-	-	-	-	-	-	-										
		Unit price																				
		<b>SA81K13220R</b>	519	-	-	-	-	-	-	-	-	-										
<b>Standard panel, 25 mm thick</b> Decor on both sides, without edging finish		Unit price																				
		<b>SA83W252</b>	312	495	-	-	-	-	-	-	-	-										
<b>Edging to fit 25 mm material,</b> 1.3 mm thick, 28 mm wide Without hot-melt adhesive	1 roll = 150 running metres (RM)	per 1 m																				
		<b>SA81W15280</b>	7,20	-	-	-	-	-	-	-	-	-										
		Unit price																				
		<b>SA81W15280R</b>	547	-	-	-	-	-	-	-	-	-										

## Accessories Worktops

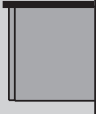

<b>Edging to fit 38 mm material,</b> 1.5 mm thick, 43 mm wide Without hot-melt adhesive	1 roll = 150 running metres (RM)	per 1 m																				
		<b>SA81A15430</b>	-	-	9,90	-	-	-	-	-	-	-										
		Unit price																				
		<b>SA81A15430R</b>	-	-	767	-	-	-	-	-	-											
Worktop decor 38 mm	2650	<b>Natural sandstone effect</b>	5573	Classic Oak																		
APD Laminate 38 mm/Thick Edge	2701	snow white spatula look effect	5579	Brown concrete effect																		
1180 natural mountain oak	3157	Piemont Oak	6290	Ferro black gold																		
1200 Roxano volcano black	3797	Mocca	6307	<b>Natural onyx effect</b>																		
1210 Metal Rock anthracite	4262	Castell Oak	8000	Crystal marble																		
1369 Dark Maron effect	4268	natural Green Ceramic	9200	Cupria marble																		
1385 Royal Oak effect	4326	<b>Elegant walnut effect</b>	9386	Seal Oak effect																		
2032 Wild Oak	4374	Concrete effect opal	9612	Graphite Black stone look																		
2240 Diamond oak effect	4375	Concrete effect pearl grey	9630	Art Pepper stone look																		
2260 Sand beige titanite	4440	graphite concrete effect																				
2406 Mountain Wood	5411	Mammoth oak natural																				
<b>Edging to fit 48 mm material,</b> 1.5 mm thick, 54 mm wide Without hot-melt adhesive	1 roll = 150 running metres (RM)	per 1 m																				
		<b>SA81A15540</b>	-	-	-	-	12,80	-	-	-	-											
		Unit price																				
		<b>SA81A15540R</b>	-	-	-	-	1027	-	-	-	-											
Worktop decor 48 mm	3157	Piemont Oak	8000	Crystal marble																		
AP5D Laminate 48 mm/Thick Edge	3797	Mocca	9200	Cupria marble																		
1180 natural mountain oak	4262	Castell Oak	9386	Seal Oak effect																		
1200 Roxano volcano black	4268	natural Green Ceramic	9612	Graphite Black stone look																		
1210 Metal Rock anthracite	4326	Elegant walnut effect	9630	Art Pepper stone look																		
1369 Dark Maron effect	4374	Concrete effect opal																				
1385 Royal Oak effect	4375	Concrete effect pearl grey																				
2032 Wild Oak	4440	graphite concrete effect																				
2240 Diamond oak effect	5411	Mammoth oak natural																				
2260 Sand beige titanite	5573	Classic Oak																				
2406 Mountain Wood	5579	Brown concrete effect																				
2650 Natural sandstone effect	6290	Ferro black gold																				
2701 snow white spatula look effect	6307	Natural onyx effect																				



# Special finish

		Hinge side:	Carcase depth	Price groups					
Order no. W H D				1					
<b>Reduction in carcass width</b> 1. Extra charge refers to next largest element.  Base units / base shelf units Dresser bar unit with folding-lifting doors Wall units, dresser units Tall units, tall shelf units									
		<b>SA50 BU</b>		86					
		<b>SA50BABFL</b>		243					
		<b>SA50 BH</b>		64					
	<b>SA50 BS</b>		131						
<b>Reduction in carcass depth</b> 1. Available with drawer and pull-out for elements over 34 cm deep – use of standard drawer and pull-out depths. 2. Depth reductions for units with adjustable glass shelves are supplied with adjustable shelves in the carcass decor. 3. Depth reductions of carcasses with adjustable shelves – usable inside depth adapted to carcass depth Base units / base shelf units Dresser bar unit with folding-lifting doors Wall units, dresser units, shelf units Tall units, tall shelf units									
		<b>SA50 TUI</b>		130					
		<b>SA50TABFL</b>		137					
		<b>SA50 THI</b>		130					
		<b>SA50 TSI</b>		145					
<b>Reduction in carcass depth</b> 1. Available with drawer and pull-out for elements over 34 cm deep – use of standard drawer and pull-out depths. 2. Depth reductions for units with adjustable glass shelves are supplied with adjustable shelves in the carcass decor. 3. Depth reductions of carcasses with adjustable shelves – usable inside depth adapted to carcass depth depth reduction up to 30 cm  <b>Dresser unit with roller shutter</b> depth reduction up to 30 cm									
		<b>SA50THJ</b>		276					
<b>Reduction in carcass height</b> Available for all grid height dimensions (drawers/doors). Other dimensions only on consultation. Base units / base shelf units Dresser bar unit with folding-lifting doors Wall units Dresser unit Wall shelf units  <b>Dresser unit with roller shutter</b> Tall units, tall shelf units		 <b>Important!</b> <i>Special heights for tall units only possible via modular system (model GMX...).</i>							
		<b>SA50 HU</b>		86					
		<b>SA50HABFL</b>		124					
		<b>SA50 HH</b>		64					
		<b>SA50 HA</b>		86					
		<b>SA50HHR</b>		72					
		<b>SA50HHJ</b>		72					
		<b>SA50 HS</b>		131					
<b>Cutout in rear carcass area</b> 1. Only possible for base units / tall units where no drawers/pull-outs are planned! 2. Cutout is not possible for diagonal units. 3. Base units with a solid top shelf 4. With corner units, only on request and prior technical check.  Base units / base shelf units Wall units, dresser units, shelf units Tall units, tall shelf units									
		<b>SA50AKU</b>		109					
		<b>SA50AKH</b>		100					
		<b>SA50AKS</b>		169					
<b>Variable width of drawers/pull-outs</b> <b>Price calculation:</b> Article SA50BU must be taken into account. Extra charge refers to next largest element.  Extra charge for width reduction 1 drawer of 31-119 cm Extra charge for width reduction 1 pull-out of 31-119 cm		 <b>Not available for:</b> <i>all handles N..., base units with connected panels, design fronts G1, G2,G2S,G5S, G6</i>							
		<b>SA50BSK</b>		48					
	<b>SA50BAZ</b>		57						
<b>Surcharge for width reductions of base cabinets with drawers / pull-outs</b>		 <b>Not available for:</b> <i>all handles N..., base units with connected panels, design fronts G1, G2,G2S,G5S, G6</i> <i>The cabinet width reduction is included in this surcharge.</i>							
		<b>SA50BKU</b>		260					
<b>Special finish</b> Width reduction for wall units with folding-lifting doors, widths from 61 - 99 cm Only available for models HFL...									
		<b>SA50 BHFL</b>		126					

# Special finish

		Order no. W H D		Price groups																
		Hinge side:	Carcase depth	1																
<b>Extra charge Sink carcase with full back panel</b>			<b>SA50SVR</b>	34																
<b>Extra charge for base units with closed top shelf</b> not available for Diagonal and corner base units			<b>MP-KBOG</b>	100																
	<b>Extra charge for heavy-duty fittings wall-mounted units</b>		<b>MP-WST</b>	105																
	<b>Extra charge for heavy-duty fittings wall-mounted units</b>		<b>MP-WST2</b>	228																
<b>Extra charge for cabinets, not yet glue-mounted but assembled</b> Cabinets come fully assembled (with all fittings, internal components, fronts etc.) and can be dismantled on site.			<b>MP-OL</b>	105																
<b>Extra charge for split GSP fronts</b> combined with N700 and N775 finger pulls including metal connector and additional finger pulls Extra charge on fronts divided into two Extra charge on fronts divided into two Extra charge on fronts divided into three Extra charge on fronts divided into three			<b>MP-GSN245</b>	114																
			<b>MP-GSN260</b>	117																
			<b>MP-GSN345</b>	196																
			<b>MP-GSN360</b>	201																
<b>Extra charge for custom-made</b> on base units, tall units and appliance units Please use this item for all special finishes, that are not listed in connection with the SA50... items. Cabinet modifications cost an extra <b>30 %</b> .																				
<b>Extra charge for Drawer/pull-out</b> LEGRABOX WOOD			<b>MP-WOOD</b>	170																
<b>Front substitution</b>																				
			<b>MP-FLDXL-10</b>	-	60	254	363	468	633	1101	1222	-								
			<b>MP-FLDXL-20</b>	-	-	194	303	408	573	1041	1162	-								
			<b>MP-FLDXL-30</b>	-	-	-	109	214	379	847	968	-								
			<b>MP-FLDXL-40</b>	-	-	-	-	105	270	738	859	-								
			<b>MP-FLDXL-50</b>	-	-	-	-	-	165	633	754	-								
			<b>MP-FLDXL-60</b>	-	-	-	-	-	-	468	589	-								
			<b>MP-FLDXL-70</b>	-	-	-	-	-	-	-	121	-								





Carcase/ accessory/ worktop decors

M10	M20	M30	M40	M50
<p><b>Laminate (decor group K)</b> K005S Castell Oak K006P Light Grey K023P Stainless Steel Colour K039G Premium white glossy K039P Premium white K043P Graphite Black K058P Magic-grey K075P Black K076P Macaron K160F Snow White K160G Snow White Gloss K178F White Agate K190S Mammoth oak natural K199S Piemont Oak K216S natural mountain oak K218P Light Pepper K229S Classic Oak K230P Art Pepper K235P Titan Steel Metallic K236S Diamond Oak effect K247S Dark Maron effect K248P Light Nude K262S Royal Oak K263P Fango K269S Mountain Wood K270S Elegant walnut</p>	<p><b>Laminate decor (decor group D)</b> D039F Premium white matt D147S Burnt Wood D149W brown concrete effect D160F Snow white matt D176S black Sherwood D178F White agate matt D187W Concrete effect opal D188W Concrete effect pearl grey D202S Sepia Grey Sherwood D212W graphite concrete D224S Bordeaux oak D250S Black Oak effect D251S Seal Oak effect D264S Light oak, grooved look D265S Dark oak, grooved look D271W Natural sandstone effect D272F Jade pastel</p>	<p><b>RESOPAL PRO (decor group I)</b> I039M Premium white I075M Black I076M Macaron Powder I138M Titanium grey I139M Jura Grey I140M Anthracite I141M cool white I240M Light Powder I241M Dark Powder I253M Moonlight Green I267M Brown Powder I268M Nature Powder</p> <p><b>PRIMEWOOD (decor group PW)</b> PW258 Gavi oak Basic veneer PW259 Dark oak Basic veneer</p> <p><b>HPL PRO (decor group I..H)</b> I273H Natural onyx effect I274H Navyblue I280H Smoke Powder I281H Ferro black gold</p>	<p><b>DIRECTLACK matt (decor group A)</b> A039M Premium white A043M Graphite Black A075M Black A076M Macaron A160M Snow White A178M White Agate A218M Light Pepper A230M Art Pepper A248M Light Nude A263M Fango</p> <p><b>DIRECTLACK high gloss (decor group L)</b> L039H Premium white L076H Macaron L160H Snow White L178H White Agate L218H Light Pepper L248H Light Nude</p>	<p><b>Velvet lacquer (decor group B)</b> B006F Light Grey B039F Premium white B043F Graphite Black B058F Magic-grey B075F Black B076F Macaron B099F special coulor B160F Snow White B178F White Agate B218F Light Pepper B230F Art Pepper B245F Night Green B248F Light Nude B263F Fango</p> <p><b>Microstructur lacquer (decor group S)</b> S006P Light Grey S039P Premium white S043P Graphite Black S058P Magic-grey S075P Black S076P Macaron S099P special coulor S160P Snow White S178P White Agate S218P Light Pepper S230P Art Pepper S245P Night Green S248P Light Nude S263P Fango</p>
M50	M60	M70	M80	M90
<p><b>Velvet lacquer wood textured (decor group R RH)</b> R006H Light Grey R039H Premium white R043H Graphite Black R058H Magic-grey R075H Black R076H Macaron R099H special coulor R160H Snow White R178H White Agate R218H Light Pepper R230H Art Pepper R245H Night Green R248H Light Nude R263H Fango</p> <p><b>Velvet lacquer leather effect (decor group R RW)</b> R006W Light Grey R039W Premium white R043W Graphite Black R058W Magic-grey R075W Black R076W Macaron R099W special coulor R160W Snow White R178W White Agate R218W Light Pepper R230W Art Pepper R245W Night Green R248W Light Nude R263W Fango</p> <p><b>Soft lacquer (decor group P)</b> P039M Premium white</p>	<p><b>SMARTGLAS high gloss (decor group QH)</b> Q075H Black Q160H Snow White Q178H White Agate Q191H Sand grey Q200H Carrara white Q201H Cream</p> <p><b>SMARTGLAS satin-finish (decor group QM)</b> Q075M Black Q160M Snow White Q178M White Agate Q191M Sand grey Q192M Taupe Q200M Carrara white Q201M Cream Q234M Carbon metallic Q244M Aqua Q254M Black Metallic Q255M Champagner Metallic Q256M Grey Metallic Q277M Silk Metallic Q278M Bronze Metallic</p>	<p><b>Veneer / oak (decor group F)</b> F039S Premium white F043S Graphite Black F058K silk grey F075S Black F076K Macaron F099K special coulor F213K natural F214K coffee brown F218S Light Pepper F230S Art Pepper F231K Walnut Veneer F245S Night Green F248S Light Nude F257K Rosso walnut veneer F258K Gavi oak veneer F259K Dark oak veneer F261K Urban Oak F263S Fango F279K Moderno Rustico</p> <p><b>Veneer / Bavaria (decor group Z)</b> Z039S Premium white Z043S Graphite Black Z058K silk grey Z075S Black Z076K Macaron Z099K special coulor Z213K natural Z214K coffee brown Z218S Light Pepper Z230S Art Pepper Z245S Night Green Z248S Light Nude Z258K Gavi oak Z259K Dark oak Z261K Urban Oak Z263S Fango Z279K Moderno Rustico</p> <p><b>Velvet lacquer textured (decor group V)</b> V182W Silver Metallic V183W Gold Metallic V194W Copper Metallic V195W Bronze Metallic V235W Titan Steel Metallic V246W Basalt Metallic</p>	<p><b>FENIX (decor group C1)</b> C023M Stainless Steel Look</p> <p><b>High-gloss lacquer (decor group H)</b> H006H Light Grey H039H Premium white H043H Graphite Black H058H Magic-grey H075H Black H076H Macaron H099H special coulor H160H Snow White H178H White Agate H218H Light Pepper H230H Art Pepper H245H Night Green H248H Light Nude H263H Fango</p> <p><b>Matt lacquer (decor group MP)</b> MP006 Light Grey MP039 Premium white MP043 Graphite Black MP058 Magic-grey MP075 Black MP076 Macaron MP099 special coulor MP160 Snow White MP178 White Agate MP218 Light Pepper MP230 Art Pepper MP245 Night Green MP248 Light Nude MP263 Fango</p> <p><b>Veneer (decor group O)</b> O170S Antique Oak O197S Light Spessart oak O215S larch O232S Leached Spessart oak O233S Honey Spessart oak O259K Dark oak</p>	<p><b>Special colours</b> U039P Premium white matt with gold-coloured applications</p> <p><b>Worktop decors</b> 1200 Roxano volcano black 1210 Metal Rock anthracite 2032 Wild Oak 2260 Sand beige titanite 2701 snow white spatula look 3797 Mocca 4268 Natural Green Ceramic 8000 Crystal marble 9200 Cupria marble 9612 Graphite Black stone look 9630 Art Pepper stone look</p>
				<p><b>M100</b></p> <p><b>Laminate Waterproof (decor group W)</b> W023M Stainless Steel Coloured Foiled</p>
				<p><b>M110</b></p> <p><b>Lamella effect (decor group E1)</b> E023F Aluminium Inox lamella effect E075F Aluminium black lamella effect</p>







## Carcase/ accessory/ worktop decors

M10	M20	M30	M40	M50
<p><b>Laminate (decor group K)</b> K005S Castell Oak K006P Light Grey K023P Stainless Steel Colour K039G Premium white glossy K039P Premium white K043P Graphite Black K058P Magic-grey K075P Black K076P Macaron K160F Snow White K160G Snow White Gloss K178F White Agate K190S Mammoth oak natural K199S Piemont Oak K216S natural mountain oak K218P Light Pepper K229S Classic Oak K230P Art Pepper K235P Titan Steel Metallic K236S Diamond Oak effect K247S Dark Maron effect K248P Light Nude K262S Royal Oak K263P Fango K269S Mountain Wood K270S Elegant walnut</p>	<p><b>Laminate decor (decor group D)</b> D039F Premium white matt D147S Burnt Wood D149W brown concrete effect D160F Snow white matt D176S black Sherwood D178F White agate matt D187W Concrete effect opal D188W Concrete effect pearl grey D202S Sepia Grey Sherwood D212W graphite concrete D224S Bordeaux oak D250S Black Oak effect D251S Seal Oak effect D264S Light oak, grooved look D265S Dark oak, grooved look D271W Natural sandstone effect D272F Jade pastel</p>	<p><b>RESOPAL PRO (decor group I)</b> I039M Premium white I075M Black I076M Macaron Powder I138M Titanium grey I139M Jura Grey I140M Anthracite I141M cool white I240M Light Powder I241M Dark Powder I253M Moonlight Green I267M Brown Powder I268M Nature Powder</p> <p><b>PRIMEWOOD (decor group PW)</b> PW258 Gavi oak Basic veneer PW259 Dark oak Basic veneer</p> <p><b>HPL PRO (decor group I..H)</b> I273H Natural onyx effect I274H Navyblue I280H Smoke Powder I281H Ferro black gold</p>	<p><b>DIRECTLACK matt (decor group A)</b> A039M Premium white A043M Graphite Black A075M Black A076M Macaron A160M Snow White A178M White Agate A218M Light Pepper A230M Art Pepper A248M Light Nude A263M Fango</p> <p><b>DIRECTLACK high gloss (decor group L)</b> L039H Premium white L076H Macaron L160H Snow White L178H White Agate L218H Light Pepper L248H Light Nude</p>	<p><b>Velvet lacquer (decor group B)</b> B006F Light Grey B039F Premium white B043F Graphite Black B058F Magic-grey B075F Black B076F Macaron B099F special coulor B160F Snow White B178F White Agate B218F Light Pepper B230F Art Pepper B245F Night Green B248F Light Nude B263F Fango</p> <p><b>Microstructur lacquer (decor group S)</b> S006P Light Grey S039P Premium white S043P Graphite Black S058P Magic-grey S075P Black S076P Macaron S099P special coulor S160P Snow White S178P White Agate S218P Light Pepper S230P Art Pepper S245P Night Green S248P Light Nude S263P Fango</p>
M50	M60	M70	M80	M90
<p><b>Velvet lacquer wood textured (decor group R RH)</b> R006H Light Grey R039H Premium white R043H Graphite Black R058H Magic-grey R075H Black R076H Macaron R099H special coulor R160H Snow White R178H White Agate R218H Light Pepper R230H Art Pepper R245H Night Green R248H Light Nude R263H Fango</p> <p><b>Velvet lacquer leather effect (decor group R RW)</b> R006W Light Grey R039W Premium white R043W Graphite Black R058W Magic-grey R075W Black R076W Macaron R099W special coulor R160W Snow White R178W White Agate R218W Light Pepper R230W Art Pepper R245W Night Green R248W Light Nude R263W Fango</p> <p><b>Soft lacquer (decor group P)</b> P039M Premium white</p>	<p><b>SMARTGLAS high gloss (decor group QH)</b> Q075H Black Q160H Snow White Q178H White Agate Q191H Sand grey Q200H Carrara white Q201H Cream</p> <p><b>SMARTGLAS satin-finish (decor group QM)</b> Q075M Black Q160M Snow White Q178M White Agate Q191M Sand grey Q192M Taupe Q200M Carrara white Q201M Cream Q234M Carbon metallic Q244M Aqua Q254M Black Metallic Q255M Champagner Metallic Q256M Grey Metallic Q277M Silk Metallic Q278M Bronze Metallic</p>	<p><b>Veneer / oak (decor group F)</b> F039S Premium white F043S Graphite Black F058K silk grey F075S Black F076K Macaron F099K special coulor F213K natural F214K coffee brown F218S Light Pepper F230S Art Pepper F231K Walnut Veneer F245S Night Green F248S Light Nude F257K Rosso walnut veneer F258K Gavi oak veneer F259K Dark oak veneer F261K Urban Oak F263S Fango F279K Moderno Rustico</p> <p><b>Veneer / Bavaria (decor group Z)</b> Z039S Premium white Z043S Graphite Black Z058K silk grey Z075S Black Z076K Macaron Z099K special coulor Z213K natural Z214K coffee brown Z218S Light Pepper Z230S Art Pepper Z245S Night Green Z248S Light Nude Z258K Gavi oak Z259K Dark oak Z261K Urban Oak Z263S Fango Z279K Moderno Rustico</p> <p><b>Velvet lacquer textured (decor group V)</b> V182W Silver Metallic V183W Gold Metallic V194W Copper Metallic V195W Bronze Metallic V235W Titan Steel Metallic V246W Basalt Metallic</p>	<p><b>FENIX (decor group C1)</b> C023M Stainless Steel Look</p> <p><b>High-gloss lacquer (decor group H)</b> H006H Light Grey H039H Premium white H043H Graphite Black H058H Magic-grey H075H Black H076H Macaron H099H special coulor H160H Snow White H178H White Agate H218H Light Pepper H230H Art Pepper H245H Night Green H248H Light Nude H263H Fango</p> <p><b>Matt lacquer (decor group MP)</b> MP006 Light Grey MP039 Premium white MP043 Graphite Black MP058 Magic-grey MP075 Black MP076 Macaron MP099 special coulor MP160 Snow White MP178 White Agate MP218 Light Pepper MP230 Art Pepper MP245 Night Green MP248 Light Nude MP263 Fango</p> <p><b>Veneer (decor group O)</b> O170S Antique Oak O197S Light Spessart oak O215S larch O232S Leached Spessart oak O233S Honey Spessart oak O259K Dark oak</p>	<p><b>Special colours</b> U039P Premium white matt with gold-coloured applications</p> <p><b>Worktop decors</b> 1200 Roxano volcano black 1210 Metal Rock anthracite 2032 Wild Oak 2260 Sand beige titanite 2701 snow white spatula look 3797 Mocca 4268 Natural Green Ceramic 8000 Crystal marble 9200 Cupria marble 9612 Graphite Black stone look 9630 Art Pepper stone look</p>
				<b>M100</b>
				<p><b>Laminate Waterproof (decor group W)</b> W023M Stainless Steel Coloured Foiled</p>
				<b>M110</b>
				<p><b>Lamella effect (decor group E1)</b> E023F Aluminium Inox lamella effect E075F Aluminium black lamella effect</p>